



**HEXAGON**



**SMART7  
Installation and Operation  
User Manual**

---

## SMART7 Installation and Operation User Manual

**Publication Number:** D100410

**Revision Level:** v2

**Revision Date:** May 2025

**Firmware Version:** 7.09.05 / OM7MR0905RN0000

### Warranty

NovAtel Inc. warrants that its GNSS products are free from defects in materials and workmanship, subject to the conditions set forth on our web site: [novatel.com/products/novatel-warranty-and-return-policies](https://novatel.com/products/novatel-warranty-and-return-policies).

### Return instructions

To return products, refer to the instructions found at: [novatel.com/products/novatel-warranty-and-return-policies](https://novatel.com/products/novatel-warranty-and-return-policies).

### Proprietary notice

This document and the information contained herein are the exclusive properties of the legal entities that comprise the Autonomous Solutions division of the Hexagon AB group of companies (“Hexagon”).

No part of this document may be reproduced, displayed, distributed, or used in any medium, in connection with any other materials, or for any purpose without prior written permission from Hexagon. Applications for permission may be directed to [contact.ap@hexagon.com](mailto:contact.ap@hexagon.com). Unauthorized reproduction, display, distribution or use may result in civil as well as criminal sanctions under the applicable laws. Hexagon aggressively protects and enforces its intellectual property rights to the fullest extent allowed by law.

This document and the information contained herein are provided AS IS and without any representation or warranty of any kind. Hexagon disclaims all warranties, express or implied, including but not limited to any warranties of merchantability, non-infringement, and fitness for a particular purpose. Nothing herein constitutes a binding obligation on Hexagon.

The information contained herein is subject to change without notice.

ALIGN, GLIDE, Inertial Explorer, NovAtel, OEM6, OEM7, PwrPak7, RTK ASSIST, SPAN, STEADYLINE, TerraStar, and Waypoint are trademarks of Hexagon AB and/or its subsidiaries and affiliates, and/or their licensors. All other trademarks are properties of their respective owners.

© Copyright 2018 – 2025 Hexagon AB and/or its subsidiaries and affiliates. All rights reserved.

---

# Table of Contents

## Figures

## Tables

## SMART7 notices

## Customer Support

### Chapter 1 SMART7 overview

1.1 Features and models .....	21
1.2 SMART7 connectors overview .....	22
1.3 SMART7 LEDs .....	23
1.4 Related documents and information .....	25

### Chapter 2 SMART7 installation

2.1 SMART antenna additional equipment required .....	27
2.2 Mounting and orienting the SMART7 .....	27
2.2.1 Mounting .....	27
2.2.2 Orienting .....	27
2.2.3 SMART7 mounting hole locations .....	28
2.2.4 Mounting plate .....	28
2.3 Connect the SMART7 to data communication equipment .....	29
2.3.1 Serial ports .....	29
2.3.2 Wi-Fi .....	30
2.3.3 Ethernet port .....	30
2.3.4 CAN bus port .....	30
2.4 Connect I/O signals to a SMART7 .....	31
2.5 Connect power to the SMART7 .....	31
2.5.1 Fuse for the power supply .....	32
2.5.2 Power supply requirements for the SMART7 .....	32
2.6 Check that the SMART7 is working .....	33

### Chapter 3 SMART7 operation

3.1 Communications with the receiver .....	35
3.1.1 Wi-Fi communications .....	35
3.1.2 Serial port communications .....	35
3.1.3 Ethernet communications .....	37
3.1.4 ICOM communications .....	37
3.1.5 CAN bus communications .....	38
3.2 Getting started .....	38
3.2.1 Communicating with the receiver .....	38
3.3 Transmitting and receiving corrections .....	39
3.3.1 Defining antenna and base antenna .....	41
3.3.2 Base station configuration .....	41
3.3.3 Rover station configuration .....	42
3.3.4 Configuration notes .....	43

3.4 ALIGN Heading base and remote configurations .....	43
3.4.1 Automatic set up for direct-wire connection between base and rover via COM2 .....	44
3.4.2 Manual set up via COM2 .....	44
3.5 GLIDE .....	44
3.5.1 Dual-frequency GLIDE .....	45
3.5.2 PDP and GLIDE configurations .....	45
3.6 STEADYLINE .....	45
3.6.1 Prefer Accuracy .....	46
3.7 Enabling SBAS positioning .....	46
3.8 TerraStar Correction Services .....	46
3.8.1 Required components .....	47
3.8.2 Receiver models needed for TerraStar Correction Services .....	47
3.8.3 Enable L-Band tracking .....	48
3.8.4 TerraStar subscriptions .....	49
3.8.5 Subscription Managed Channel Configuration .....	50
3.8.6 Additional information .....	51
3.9 RTK ASSIST Services .....	51
3.10 Terrain Compensation .....	52
3.10.1 Configuring Terrain Compensation .....	53
3.10.2 Configuring Terrain Compensation using a NMEA command .....	58
3.11 SMART antenna Emulated Radar .....	59
3.11.1 Emulated Radar (ER) .....	59
3.12 Logging using NovAtel Application Suite or Manage Web .....	59
3.13 Precision Time Protocol .....	60
3.13.1 Configuring PTP .....	60
3.13.2 Configuration notes .....	60
3.13.3 Monitoring the PTP status .....	61
3.13.4 Troubleshooting .....	61

## **Chapter 4 SMART7 with SPAN operation**

4.1 Fundamentals of GNSS+INS .....	62
4.2 Definition of reference frames within SPAN .....	63
4.2.1 Local-level frame (ENU) .....	63
4.2.2 IMU body frame .....	64
4.2.3 Vehicle frame .....	64
4.2.4 User output frame .....	65
4.3 SPAN translations and rotations – SMART7 .....	65
4.3.1 Translational offsets .....	65
4.3.2 Rotational offsets .....	67
4.3.3 Importance of RBV calibration .....	71
4.4 Vibration considerations .....	73
4.4.1 Sources of error .....	73
4.4.2 Mitigation methods .....	74
4.4.3 Additional notes .....	74
4.5 Software configuration .....	74
4.5.1 GNSS configuration .....	74
4.5.2 SPAN configuration for SMART7-S .....	75
4.6 Real-time operation .....	76

4.6.1 System start-up and alignment techniques .....	77
4.6.2 INS Seed / Fast INS initialization .....	81
4.6.3 Navigation mode .....	83
4.6.4 Data collection .....	83
4.6.5 Recommended messages to be logged for SPAN data collection .....	85
4.6.6 Body to vehicle frame rotation calibration routine .....	86
4.6.7 Multi-line body to vehicle frame rotation calibration routine .....	87
4.7 Azimuth sources on a SPAN system .....	89
4.7.1 Course over ground .....	89
4.7.2 Inertial azimuth .....	89
4.7.3 ALIGN azimuth .....	90
4.8 Data collection for post processing .....	90

## Chapter 5 Wi-Fi configuration

5.1 Wi-Fi modes .....	93
5.1.1 Access Point (AP) .....	93
5.1.2 Client .....	93
5.1.3 Concurrent .....	93
5.2 Wi-Fi modes .....	94
5.2.1 Enable the Wi-Fi access point .....	94
5.2.2 Enable the Wi-Fi client .....	94
5.2.3 Enable the Wi-Fi concurrent .....	96
5.3 Wi-Fi changes .....	97
5.3.1 Change the Wi-Fi passkey .....	97
5.3.2 Change the SSID .....	97
5.3.3 Change the Wi-Fi channel .....	97
5.3.4 Change the Wi-Fi IP address .....	98
5.3.5 Disable Wi-Fi .....	98
5.4 ALIGN over Wi-Fi overview .....	98
5.4.1 Automatic Wi-Fi ALIGN corrections .....	98
5.4.2 Manual set up for Wi-Fi connection between base and rover via ICOM1 .....	100

## Chapter 6 Ethernet configuration

6.1 Required hardware .....	102
6.2 Static IP address configuration .....	102
6.2.1 Static IP address configuration—receiver .....	103
6.2.2 Static IP address configuration—Windows 7 .....	103
6.2.3 Confirming Ethernet setup .....	104
6.3 Dynamic IP address configuration .....	104
6.4 Base/rover configuration through Ethernet connectivity .....	105
6.5 Large Ethernet port data throughput .....	107

## Chapter 7 NTRIP configuration

7.1 NTRIP configuration over Ethernet .....	108
7.2 NTRIP configuration over Wi-Fi .....	109

## Chapter 8 CAN bus

8.1 Default configuration .....	112
---------------------------------	-----

8.2 Configuring the CAN bus .....	113
8.2.1 Configuration notes .....	113
8.2.2 Example of enabling the CAN bus .....	113
8.2.3 Example of modifying the CAN bus parameters .....	114
8.2.4 Example of detecting an address claim failure and reconfiguring .....	114
8.2.5 Address claim procedure .....	114
8.3 NMEA2000 logging .....	115
8.3.1 Example of NMEA2000 log configuration .....	115
8.4 Corrections over CAN .....	115
8.4.1 Example for receiving corrections from any source .....	116
8.4.2 Example for transmitting corrections to 0x1C node .....	116
8.5 NovAtel messages over CAN .....	116
8.6 Configuring OEM7 receivers to use OEM6 CAN settings .....	117
8.6.1 Configuration on OEM6 .....	117
8.6.2 Configuration on OEM7 .....	117

## Chapter 9 Built-In Status Tests

9.1 RXSTATUSEVENT log .....	118
9.2 RXSTATUS log .....	118
9.2.1 Status word .....	118
9.2.2 Error word .....	119
9.2.3 Status code arrays .....	119
9.2.4 Receiver status code .....	120
9.2.5 Auxiliary status codes .....	120
9.2.6 Set and clear mask for all status code arrays .....	120

## Chapter 10 Troubleshooting

10.1 Examining the RXSTATUS log .....	123
10.2 Examining the AUX1 status word .....	126
10.3 High temperature environments .....	128
10.3.1 Indicators of an error state .....	128
10.3.2 Recovering from a temperature status error .....	128
10.3.3 Mitigating high receiver temperature .....	128
10.3.4 Monitoring the receiver temperature .....	128
10.4 Safe Mode .....	129
10.4.1 Reset loop detection .....	130
10.4.2 Recovery steps .....	130

## Chapter 11 NovAtel firmware

11.1 Firmware updates and model upgrades .....	131
11.1.1 Firmware updates .....	131
11.1.2 Model upgrades .....	131
11.1.3 Firmware downgrades .....	131
11.2 Authorization code .....	131
11.3 Downloading firmware files .....	132
11.3.1 Format of firmware files .....	132
11.4 Updating or upgrading using the WinLoad utility .....	133
11.4.1 Open a file to download .....	133

---

11.4.2 Communications settings .....	134
11.4.3 Downloading firmware .....	135
11.5 Updating the firmware using NovAtel Application Suite .....	135
11.6 Updating the firmware using Manage Web .....	136
11.7 Updating using SoftLoad commands .....	136
11.7.1 Implementing SoftLoad .....	136
11.7.2 Use SoftLoad Customer Support utilities .....	137
11.7.3 Self-implement the SoftLoad process .....	143
11.8 Update Manage Web .....	148
11.8.1 Update Manage Web content using NovAtel Application Suite .....	148
11.8.2 Update Manage Web content using Manage Web .....	148
11.9 Upgrading using an Auth-Code .....	149
11.9.1 Entering an Auth-Code using NovAtel Application Suite .....	149
11.9.2 Entering an Auth-Code using Manage Web .....	149
11.9.3 Entering an Auth-Code Using the Command Line .....	150

## **Appendix A SMART7 technical specifications**

A.1 SMART7 performance specifications .....	152
A.2 SMART7 mechanical specifications .....	156
A.3 SMART7 environmental and electrical specifications .....	158
A.4 SMART7 data communication specifications .....	159
A.5 SMART7 strobe specifications .....	160
A.6 SMART Antenna interface cable (optional accessory) .....	161
A.6.1 SMART Antenna custom cable recommendation .....	163
A.7 SMART7 mounting plate specifications .....	164

## **Appendix B SMART7 accessories and replacement parts**

# Figures

---

Figure 1: SMART7 with Ethernet model (Back) .....	22
Figure 2: SMART7 interface connector .....	22
Figure 3: SMART7 Ethernet connector (model dependent) .....	23
Figure 4: SMART7 LEDs location .....	23
Figure 5: SMART7 installation .....	26
Figure 6: SMART7 orientation .....	28
Figure 7: SMART7 and SMART6 mounting hole locations .....	28
Figure 8: SMART7 mounting plate .....	29
Figure 9: Basic differential setup .....	40
Figure 10: Positioning Change Without STEADYLINE .....	45
Figure 11: STEADYLINE Prefer Accuracy .....	46
Figure 12: Terrain Compensation – roll .....	52
Figure 13: Terrain Compensation – pitch .....	53
Figure 14: SMART antenna installation .....	54
Figure 15: SMART antenna orientation .....	55
Figure 16: Antenna height measurement .....	56
Figure 17: Local-level frame (ENU) .....	64
Figure 18: Vehicle frame .....	65
Figure 19: ALIGN translation offset .....	66
Figure 20: SMART7-S and SMART7-SI IMU body frame .....	68
Figure 21: SMART7-S and SMART7-SI IMU body frame with factory configured rotation .....	69
Figure 22: SMART7-S installed with orientation not aligned with vehicle frame .....	70
Figure 23: Rear view of SMART7-S on a vehicle – roof camber .....	72
Figure 24: Side view of SMART7-S on a vehicle – roof tilt .....	72
Figure 25: Top view of SMART7-S on a vehicle – SMART7-S misalignment .....	72
Figure 26: Multi-line IMU body to vehicle calibration .....	88
Figure 27: Cross-over Ethernet cable configuration—OEM7 receiver .....	103
Figure 28: Dynamic IP address configuration through a DHCP server—OEM7 receiver .....	105
Figure 29: Base/rover Ethernet setup—OEM7 receiver .....	106
Figure 30: NTRIP system .....	108
Figure 31: Location of receiver status word .....	118
Figure 32: Reading the bits in the receiver status word .....	119
Figure 33: Location of receiver error word .....	119
Figure 34: Reading the bits in the receiver error word .....	119

Figure 35: Status code arrays .....	120
Figure 36: WinLoad's Open Window .....	133
Figure 37: Open File in WinLoad .....	134
Figure 38: COM Port Setup .....	134
Figure 39: SMART7 dimensions .....	156
Figure 40: SMART7-S and SMART7-SI center of navigation .....	157
Figure 41: SMART Antenna interface cable .....	161
Figure 42: SMART7 mounting plate dimensions .....	164

# Tables

---

Table 1: Hardware options .....	22
Table 2: SMART7 connector pinout .....	22
Table 3: Ethernet connector pinout .....	23
Table 4: SMART7 status indicators .....	24
Table 5: Wi-Fi LED .....	24
Table 6: Ethernet LED .....	24
Table 7: SMART7 Status LED .....	24
Table 8: SMART antenna recommended fuse and fuse holders .....	32
Table 9: Serial ports supported .....	36
Table 10: Inertial solution status .....	76
Table 11: NVM seed indication .....	83
Table 12: Solution parameters .....	84
Table 13: Logs with azimuth data .....	90
Table 14: Wi-Fi default configuration .....	93
Table 15: Default NAME .....	112
Table 16: Troubleshooting based on symptoms .....	122
Table 17: Resolving a receiver error word .....	123
Table 18: Resolving an error in the receiver status word .....	124
Table 19: Resolving an error in the AUX1 status word .....	126
Table 20: RF paths for OEM7 receivers .....	127
Table 21: SMART7 physical description .....	151
Table 22: SMART7 receiver performance .....	152
Table 23: SMART7-S IMU performance .....	154
Table 24: SMART7 environmental specifications .....	158
Table 25: SMART7 power requirements .....	158
Table 26: Data communications interfaces .....	159
Table 27: SMART7 strobes description .....	160
Table 28: SMART Antenna interface cable connector pinout .....	162
Table 29: 14-pin interface signal specifications .....	162
Table 30: I/O connector .....	163
Table 31: SMART7 hardware options .....	165
Table 32: RELAY7 accessory products .....	165

## SMART7 notices

---

The following notices apply to the SMART7 device.



**Changes or modifications to this equipment, not expressly approved by NovAtel Inc., could void the user's authority to operate this equipment.**

### FCC

This device complies with part 15 of the FCC Rules. Operation is subject to the following two conditions: (1) this device may not cause harmful interference, and (2) this device must accept any interference received, including interference that may cause undesired operation.

SMART7 has been tested and found to comply with the radiated and conducted emission limits for a Class B digital device. The Class B limits are designed to provide reasonable protection against harmful interference in a residential installation.

The equipment listed generates, uses and can radiate radio frequency energy and, if not installed and used in accordance with the instructions, may cause harmful interference to radio communications. However, there is no guarantee that interference will not occur in a particular installation. If this equipment does cause harmful interference to radio or television reception, which can be determined by turning the equipment off and on, the user is encouraged to try to correct the interference by one or more of the following measures:

- Re-orient or relocate the SMART7
- Increase the separation between the equipment and the SMART7
- Connect the equipment to an outlet on a circuit different from that to which the SMART7 is connected
- Consult the dealer or an experienced Radio/TV technician for help



**The SMART7 has been authorized for use in Mobile applications. At least 20 cm (8 inches) of separation between the SMART7 and the User must be maintained at all times.**

### Wi-Fi

SMART7 contains a Wi-Fi radio with the following approvals:

- FCC ID: UTU-01019715

### Innovation, Science and Economic Development (ISED) Canada

SMART7 Class B digital device complies with Canadian ICES-003.

SMART7 appareil numérique de la classe B est conforme à la norme NMB-003 du Canada.

This device complies with ISED license-exempt RSS-GEN and RSS-247. Operation is subject to the following two conditions: (1) this device may not cause interference and (2) this device must accept any interference, including interference that may cause undesired operation of the device.

Cet appareil est conforme à la norme ISED RSS-GEN et RSS-247. Son fonctionnement est soumis aux deux conditions suivantes: (1) cet appareil ne doit pas provoquer d'interférences et (2) cet appareil doit accepter toute interférence, y compris les interférences pouvant entraîner un fonctionnement indésirable de l'appareil.

**The SMART7 has been authorized for use in Mobile applications. At least 20 cm (8 inches) of separation between the SMART7 and the User must be maintained at all times.**

**Le SMART7 a été autorisé pour une utilisation dans les applications mobiles. Au moins 20 cm (8 pouces) de séparation entre le SMART7 et l'utilisateur doit être maintenue à tous fois.**

## Wi-Fi

SMART7 contains a Wi-Fi radio with the following approvals:

- IC: 129A-01019715

## European Union (EU) / United Kingdom (UK)

### SMART7 Wi-Fi

NovAtel Inc. declares that the SMART7 is in compliance with:

1. EU Directive 2014/53/EU
2. UK Regulations S.I. 2017/1206

The full text of the EU Declaration of Conformity may be obtained from the NovAtel web site at:

[novatel.com/products/novatel-compliance](http://novatel.com/products/novatel-compliance)

### Radio information

Description of Service: Wi-Fi (802.11b/g/n)

Operational Frequency: 2400 MHz to 2480 MHz

Modulation: OFDM

Rated Power: 13.4 dBm e.i.r.p

The full text of the EU Declaration of Conformity may be obtained from the NovAtel web site at:

[novatel.com/products/novatel-compliance](http://novatel.com/products/novatel-compliance)

### WEEE notice

If you purchased your SMART7 product in Europe or the United Kingdom, please return it to your dealer or supplier at the end of its life. The objectives of NovAtel's environment policy are, in particular, to preserve, protect and improve the quality of the environment, protect human health and utilise natural resources prudently and rationally. Sustainable development advocates the reduction of wasteful consumption of natural resources and the prevention of pollution. Waste electrical and electronic equipment (WEEE) is a regulated area. Where the generation of waste cannot be avoided, it should be reused or recovered for its material or

energy. WEEE products may be recognized by their wheeled bin label (.

See [novatel.com/products/novatel-compliance/novatel-environmental-compliance](http://novatel.com/products/novatel-compliance/novatel-environmental-compliance) for more information.

### RoHS

The SMART7 is in conformity with:

1. Directive 2011/65/EU of the European Parliament and of the council of 8 June 2011 on the restriction of the use of certain hazardous substances in electrical and electronic equipment.
2. the Restriction of the Use of Certain Hazardous Substances in Electrical and Electronic Equipment (Amendment) Regulations 2012 (S.I. 2012/3032).

## E-Mark

The SMART7 has been granted EC type approval of an electric/electronic subassembly with respect to electromagnetic compatibility ECE Regulation 10.05. Therefore the equipment is labeled with the following approval marks.

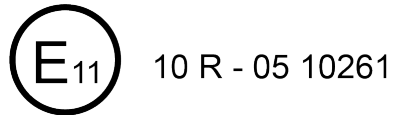

## Ethernet port



**The Ethernet port is a safety extra-low voltage (SELV) circuit only and is suitable for connection to another SELV circuit. Do not connect to Telecommunications Network Voltage (TNV) circuits.**

## SMART7 international type approvals

### Argentina

CNC ID: C-22910

### Australia and New Zealand



### Brazil



**06321-18-02494**

Este equipamento não tem direito à proteção contra interferência prejudicial e não pode causar interferência em sistemas devidamente autorizados.

Este produto está homologado pela Anatel, de acordo com os procedimentos regulamentados para avaliação da conformidade de produtos para telecomunicações e atende aos requisitos técnicos aplicados. Para maiores informações, consulte o site da Anatel – <https://www.gov.br/anatel/pt-br>

### China

CMITT ID: 2018DJ6039

### Eurasian Economic Community

Armenia, Belarus, Kazakhstan, Kyrgyzstan and Russia



### Israel

א. מספר האישור האלחוטי של משרד התקשורת הוא 51-67195.  
ב. אסור להחליף את האנטנה המקורית של המכשיר, וגם לא לבצע בו שינויים טכניים אחרים.

## Japan

### Wi-Fi

SMART7 contains a Wi-Fi radio with the following approvals:

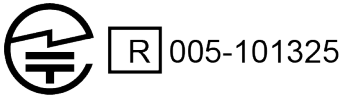

## Korea

### Wi-Fi

SMART7 contains a Wi-Fi radio with the following approvals:

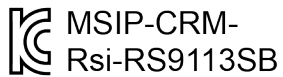

## Paraguay



## Serbia



V005 19

## South Africa

TA-2019/015  
APPROVED

## UAE



## Ukraine



## Uruguay

Este producto contiene módulo WiFi: RS9113-N00-S0C

## Zambia



ZMB/ZICTA/TA/9/40

## Conventions

The following conventions are used in this manual:



Information that supplements or clarifies text.



A caution that actions, operation or configuration may lead to incorrect or improper use of the hardware.



A warning that actions, operation or configuration may result in regulatory noncompliance, safety issues or equipment damage.

# Customer Support

---

## NovAtel knowledge base

If you have a technical issue, visit the NovAtel Support page at [novatel.com/support](http://novatel.com/support). Through the *Support* page you can contact Customer Support, find papers and tutorials or download the latest firmware. To access the latest user documentation, visit [docs.novatel.com/OEM7](http://docs.novatel.com/OEM7).

## Before contacting Customer Support

Before contacting NovAtel Customer Support about a software problem, perform the following steps:



If logging data over an RS-232 serial cable, ensure that the configured baud rate can support the data bandwidth (see **SERIALCONFIG** command). NovAtel recommends a minimum suggested baud rate of 230400 bps.

1. Use the information in the *Troubleshooting* on page 122 section to diagnose and troubleshoot your receiver's symptoms.
2. Log the data suggested in the appropriate *Troubleshooting Logs* section to a file on your computer for 15 minutes.
  - *General troubleshooting logs* on the next page
  - *Tracking and interference troubleshooting logs* on the next page
  - *SPAN troubleshooting logs* on page 19
  - *RTK troubleshooting logs* on page 19
  - *PPP troubleshooting logs* on page 20
  - *ALIGN troubleshooting logs* on page 20

If using NovAtel Application Suite, log the Troubleshooting message set for 15 minutes.

3. Send the data file to NovAtel Customer Support: [support.novatel@hexagon.com](mailto:support.novatel@hexagon.com)
4. You can also issue a **FRESET** command to the receiver to clear any unknown settings.



The **FRESET** command will erase all user settings. You should know your configuration (by requesting the RXCONFIGA log) and be able to reconfigure the receiver before you send the **FRESET** command.

If you are having a hardware problem, send a list of the troubleshooting steps taken and the results.

## Contact information

Log a support request with NovAtel Customer Support using one of the following methods:

### Log a case and search knowledge:

Website: [novatel.com/support](http://novatel.com/support)

**Log a case, search knowledge and view your case history:** (login access required)

Web Portal: [shop.novatel.com/novatelstore/s/login/](http://shop.novatel.com/novatelstore/s/login/)

**E-mail:**

[support.novatel@hexagon.com](mailto:support.novatel@hexagon.com)

**Telephone:**

U.S. and Canada: 1-800-NOVATEL (1-800-668-2835)

International: +1-403-295-4900

## General troubleshooting logs

```
LOG RXSTATUSB ONCHANGED
LOG RAWEPHEMB ONNEW
LOG GLORAWEPHEMB ONNEW
LOG BESTPOSB ONTIME 1
LOG RANGE B ONTIME 0.5
LOG RXCONFIGA ONCE
LOG VERSIONA ONCE
LOG LOGLISTA ONCE
LOG PORTSTATSA ONTIME 10
LOG PROFILEINFOA ONCE
LOG HWMONITORA ONTIME 10
```

If you have a RELAY7, add the following logs:

```
LOG SATELSTATUSB onchanged
LOG INTERFACEMODEB onchanged
LOG SERIALCONFIGB onchanged
```

## Tracking and interference troubleshooting logs

```
LOG VERSIONA ONCE
LOG RXCONFIGA ONCE
LOG CHANCONFIGLISTB ONCE
LOG PASSTHROUGHHA ONNEW
LOG RXSTATUSB ONCHANGED
LOG CLOCKSTEERINGB ONCHANGED
LOG RAWEPHEMB ONNEW
LOG GLORAWEPHEMB ONNEW
LOG GALINAVRAWEPHEMERISB ONNEW
LOG BDSEPEHEMERISB ONNEW
LOG QZSSEPEHEMERISB ONNEW
LOG NAVICEPEHEMERISB ONNEW
LOG RAWALMB ONNEW
LOG GLORAWALMB ONNEW
LOG GALALMANACB ONNEW
LOG BDSALMANACB ONNEW
LOG QZSSALMANACB ONNEW
LOG NAVICALMANACB ONNEW
LOG IONUTC B ONNEW
LOG GLOCLOCKB ONNEW
LOG GALCLOCKB ONNEW
LOG BDSCLOCKB ONNEW
```

```
LOG TRACKSTATB ONTIME 1
LOG RANGE ONTIME 0.5
LOG BESTPOSB ONTIME 1
LOG SATVIS2B ONTIME 30
LOG ITDETECTSTATUSB ONCHANGED
```

For interference issues add this log:

```
LOG ITPSDDETECTB ONNEW
```

For interference issues, when you have enough datalink bandwidth to handle large logs, add this log:

```
LOG ITPSDFINALB ONNEW
```

## SPAN troubleshooting logs

```
LOG RXSTATUSB ONCHANGED
LOG RAWEPHEMB ONNEW
LOG GLORAWEPHEMB ONNEW
LOG GALINAVRAWEPHEMERISB ONNEW
LOG BDSEPEHEMERISB ONNEW
LOG BESTPOSB ONTIME 1
LOG RANGE ONTIME 0.5
LOG RXCONFIGA ONCE
LOG VERSIONA ONCE
LOG RAWIMUSXB ONNEW
LOG INSUPDATESTATUSB ONCHANGED
LOG INSPVAXB ONTIME 1
LOG INSCONFIGA ONCHANGED
LOG BESTGNSSPOSB ONTIME 1
```

## RTK troubleshooting logs

```
LOG RXSTATUSB ONCHANGED
LOG RAWEPHEMB ONNEW
LOG GLORAWEPHEMB ONNEW
LOG QZSSRAWEPHEMB ONNEW
LOG BDSRAWNAVSUBFRAMEB ONNEW
LOG GALFNAVRAWEPHEMERISB ONNEW
LOG GALINAVRAWEPHEMERISB ONNEW
LOG RANGE ONTIME 0.5
LOG BESTPOSB ONTIME 1.0
LOG RXCONFIGB ONCE
LOG VERSIONB ONCE
LOG TRACKSTATB ONTIME 1.0
LOG RTKPOSB ONTIME 1.0
LOG MATCHEDPOSB ONNEW
LOG MATCHEDSATS ONNEW
LOG RTKSATS ONTIME 1.0
LOG PSRPOSB ONTIME 1.0
LOG RAWALMB ONNEW
LOG IONUTC ONNEW
LOG GLORAWALMB ONNEW
LOG GLOCLOCKB ONNEW
LOG PASSTHROUGH ONNEW
LOG CLOCKMODEL ONTIME 1.0
LOG REFSTATION ONNEW
LOG RTKVEL ONTIME 1.0
```

## PPP troubleshooting logs

```
LOG RXSTATUSB ONCHANGED
LOG GPSEPEMB ONNEW
LOG GLOEPHEMERISB ONNEW
LOG QZSSEPEMERISB ONNEW
LOG BDSEPEMERISB ONNEW
LOG BDSBCNAV1EPHEMERISB ONNEW (firmware versions 7.08.03 and 7.08.10 and later)
LOG BDSBCNAV2EPHEMERISB ONNEW (firmware versions 7.08.03 and 7.08.10 and later)
LOG BDSBCNAV3EPHEMERISB ONNEW (firmware versions 7.08.03 and 7.08.10 and later)
LOG GALFNAVEPEMERISB ONNEW
LOG GALINAVEPEMERISB ONNEW
LOG RANGE B ONTIME 0.5
LOG BESTPOS B ONTIME 1.0
LOG RXCONFIG B ONCE
LOG VERSION B ONCE
LOG TRACKSTAT B ONTIME 10.0
LOG LBANDTRACKSTAT B ONTIME 1.0
LOG PPPPOS B ONTIME 1.0
LOG PPPSATSB ONTIME 1.0
LOG TERRASTARINFOB ONCHANGED
LOG TERRASTARSTATUSB ONCHANGED
LOG PSRPOS B ONTIME 1.0
LOG ALMANAC B ONNEW
LOG GLOALMANAC B ONNEW
LOG GALALMANAC B ONNEW
LOG BDSALMANAC B ONNEW
LOG QZSSALMANAC B ONNEW
LOG IONUTCB ONNEW
LOG GLOCLOCKB ONNEW
LOG LBANDBEAMTABLEB ONCHANGED
```

## ALIGN troubleshooting logs

```
LOG RXSTATUSB ONCHANGED
LOG RAWEPHEMB ONNEW
LOG GLORAWEPHEMB ONNEW
LOG GALINAVRAWEPHEMERISB ONNEW
LOG BDSEPEMERISB ONNEW
LOG BESTPOS B ONTIME 1
LOG RANGE B ONTIME 0.5
LOG RXCONFIG A ONCE
LOG VERSION A ONCE
LOG LOGLISTA ONCE
LOG PORTSTATSA ONTIME 10
LOG ALIGNBSLNENUB ONNEW
LOG ALIGNBSLNXYZB ONNEW
LOG ALIGNDOPB ONNEW
LOG HEADING2B ONNEW
LOG MASTERPOS B ONNEW
LOG ROVERPOS B ONNEW (This log can only be output on a receiver where ALIGN is enabled.)
LOG HEADINGSATSA ONNEW (This log can only be output on a receiver where ALIGN is enabled and configured as the ALIGN rover.)
LOG DUALANTENNAHEADING B ONTIME 1.0
```

# Chapter 1 SMART7 overview

---

The SMART7 is a high performance GNSS receiver and antenna, optimized to provide position, velocity, attitude and timing for tractor guidance / auto-steer and precision agriculture. Models are available with repeatable centimetre-level accuracy using RTK or TerraStar corrections and with integrated inertial navigation for high availability and terrain compensation. The receiver can use all current GNSS constellations and signals. Support for SBAS (Satellite Based Augmentation Systems) is standard and includes WAAS (North America), EGNOS (Europe) and MSAS (Japan). Dual-frequency GLIDE and STEADYLINE provide smooth, consistent guidance for optimal coverage in challenging conditions. The rugged, sealed enclosure mounts securely to the vehicle roof, uses vehicle power directly and provides extensive diagnostics including external LED status indication.

Refer to *An Introduction to GNSS* available on our website at [novatel.com/an-introduction-to-gnss](http://novatel.com/an-introduction-to-gnss) for an overview of each of the above signal types.

Once properly powered, the SMART7 begins operating as a fully functional GNSS system.

## 1.1 Features and models

The main features of the SMART7 are:

- an enhanced high performance multi-frequency, multi-constellation receiver
- a high performance GNSS multi-frequency, multi-constellation antenna
- SBAS
- GLIDE
- STEADYLINE
- a CAN port
- Emulated Radar Output
- three (3) RS-232 COM ports
- up to three (3) LED status indicators (model dependent)
- a water and dust tight enclosure
- enhanced interference mitigation

The SMART7 is available in several different hardware configuration and firmware models whose additional features may include:

- RTK (Real-Time Kinematic) differential positioning
- TerraStar PPP (Precise Point Positioning)
- Terrain Compensation
- Wi-Fi interface
- Ethernet port
- Integrated SPAN GNSS+INS functionality
- Web UI

Contact NovAtel Sales at [novatel.com/contactus/sales-offices](http://novatel.com/contactus/sales-offices) for information regarding available models, upgrading a model to increase feature/functionality or go to [novatel.com/products/smart-antennas/smart7-products](http://novatel.com/products/smart-antennas/smart7-products). Refer to *Firmware updates and model upgrades* on page 131 for details.

**Table 1: Hardware options**

Tradename	Description
SMART7	SMART7
SMART7-W	SMART7 with Wi-Fi
SMART7-I	SMART7 with Wi-Fi and Ethernet
SMART7-S	SMART7 with SPAN IMU
SMART7-SI	SMART7 with SPAN IMU, Wi-Fi and Ethernet

**Figure 1: SMART7 with Ethernet model (Back)**

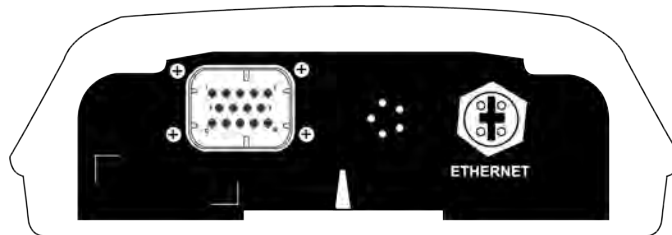

Do not cover the SMART7 pressure vent. The pressure vent must be allowed to breathe to ensure proper SMART7 operation.

## 1.2 SMART7 connectors overview

All SMART7 models use the same connector for power and communication.

**Figure 2: SMART7 interface connector**

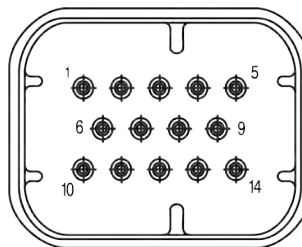

**Table 2: SMART7 connector pinout**

Pin	Use	Pin	Use
1	COM1 TxD	8	COM3 TxD
2	COM1 RxD	9	Power Negative/Return
3	COM2 TxD	10	ER_OUT (Emulated Radar Output)
4	COM2 RxD	11	Reserved

Pin	Use	Pin	Use
5	Signal Ground (COM/PPS/ER)	12	PPS (Pulse Per Second) Output
6	CAN+	13	COM3 RxD
7	CAN-	14	Power Positive/Source

The SMART7 Ethernet model has a M12 D-code male connector.

**Figure 3: SMART7 Ethernet connector (model dependent)**



**Table 3:  
Ethernet connector pinout**

Pin #	Signal name
1	Tx+
2	Rx+
3	Tx-
4	Rx-
Shell	Chassis GND



### 1.3 SMART7 LEDs

The SMART7 has up to three LEDs (model dependent) to indicate receiver status. The following tables provide information about the SMART7 LEDs and their states.

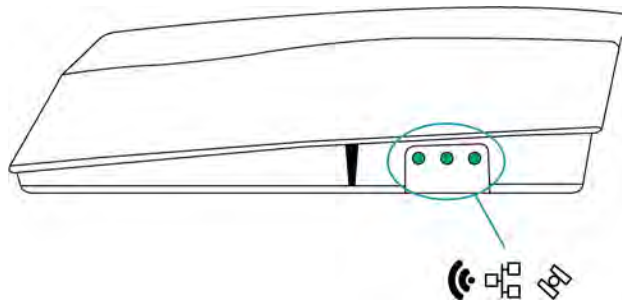
**Figure 4: SMART7 LEDs location**



**Table 4: SMART7 status indicators**

Label	Description	Variants
	Wi-Fi mode (AP, Concurrent or Client)	SMART7-I, SMART7-W and SMART7-SI
	Ethernet (DATA)	SMART7-I and SMART7-SI
	Status (Power/GNSS)	All variants

**Table 5: Wi-Fi LED**

State	Description
Green Solid	Configured as an Access Point (default)
Green Slow Flash	Configured as an Access Point with at least one client connection
Blue Solid	Configured as both an Access Point and a Client concurrently
Blue Slow Flash	Configured as both an Access Point and a Client concurrently, with at least one Client connected to the concurrent Access point or with the concurrent Client connected to an Access Point
White Solid	Configured as a Client
White Slow Flash	Configured as a Client and connected to an Access Point
Yellow Slow Flash	Wi-Fi Firmware Upgrade
Red Solid	No Configuration
Red Fast Flash	Error State

**Table 6: Ethernet LED**

State	Description
Green Solid	Link established
Green Slow Flash	Active (receiving or transmitting)

**Table 7: SMART7 Status LED**

State	Description
Green Solid	Precise solution good (RTK/PPP, Fixed or RTK/PPP+INS)
Green Slow Flash (1 Hz)	Precise solution converging
Yellow Solid	Basic solution (Single Point/SBAS/DGPS)
Yellow Slow Flash (1 Hz)	Tracking satellites and calculating initial position solution

State	Description
Yellow Fast Flash (3 Hz)	Initialized and ready for communication
Red Solid (Initial)	Power On/Reset (for about 10 seconds after power-on or reset)
Red Solid (Continuous)	Receiver system error, if indicator persists after 30 seconds
Red Slow Flash (1 Hz)	Position quality warning (unreliable/high error)
Red Fast Flash (3 Hz)	Positioning failure (unusable)

## 1.4 Related documents and information

After the receiver is set up, the [OEM7 Commands and Logs Reference Manual](#) becomes the primary source for command and log information.



Each receiver has a specific set of features, so some commands and logs may not be supported by your model.

Refer to our web site [docs.novatel.com/OEM7](https://docs.novatel.com/OEM7) for the latest documentation.

This manual does not cover receiver service and repair. Contact a local NovAtel dealer for service or repair inquiries (refer to *Customer Support* on page 17 for contact details).

## Chapter 2 SMART7 installation

When the appropriate equipment is selected, complete the following steps to set up and begin using the NovAtel GNSS receiver.

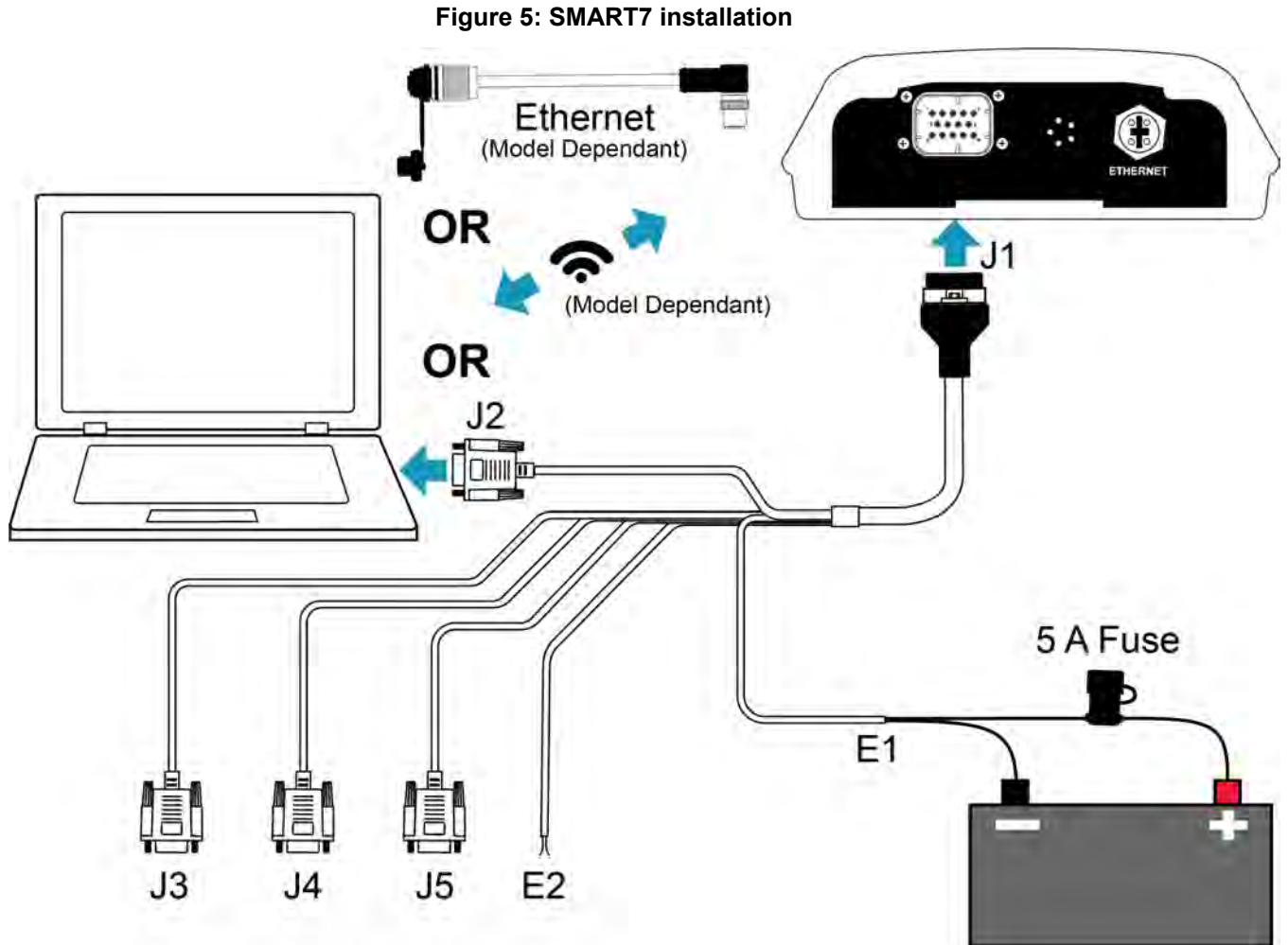

1. Mount the SMART7 receiver.  
Refer to *Mounting and orienting the SMART7* on the next page for mounting details.
2. Connect other GNSS system components using the output lines.  
See *SMART Antenna interface cable (optional accessory)* on page 161.
3. Connect the receiver to other GNSS system components, such as a computer or data terminal, using the communication ports or Wi-Fi.  
See *Connect the SMART7 to data communication equipment* on page 29.
4. Connect the interface cable to the interface connector on the receiver.
5. Connect the power cable to the power supply.

See *Connect power to the SMART7* on page 31 for details.

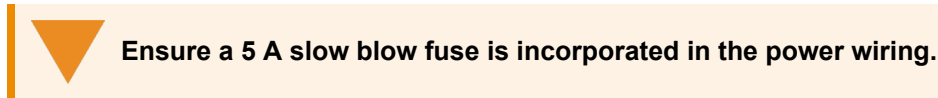

## 2.1 SMART antenna additional equipment required

In order for a SMART Antenna to perform optimally, the following additional equipment is required:

- A computer (user supplied)
- A cable harness for communicating with and powering the SMART Antenna (NovAtel *SMART Antenna interface cable (optional accessory)* on page 161 is available with four DB-9 connectors, six bare cables and a SMART Antenna connector)
- A fused +7 to +30 VDC power supply (user supplied)  
Refer to *Power supply requirements for the SMART7* on page 32 for details.

## 2.2 Mounting and orienting the SMART7

### 2.2.1 Mounting

Mount the SMART7 on a secure, stable structure capable of safe operation in the specific environment. Ensure the SMART7 has a clear view of the sky.

- If installing on a vehicle, mount the SMART7 on the vehicle roof, ideally close to the pivot point of the vehicle. The SMART7 must be mounted with the connector facing the rear of the vehicle and the top up with an unobstructed view of the sky in all directions.

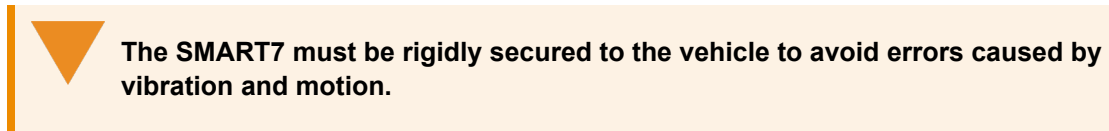

- If installing in a stationary location, mount the SMART7 in a location that has a clear view of the sky so that each satellite above the horizon can be tracked without obstruction. For more information, refer to *An Introduction to GNSS* available on our website at [novatel.com/an-introduction-to-gnss](http://novatel.com/an-introduction-to-gnss).

The SMART7 can be mounted to the vehicle using the integrated magnets, an optional mounting plate or four M4 screws.

### 2.2.2 Orienting

Ensure the SMART7 is oriented with the connector(s) facing the back of the vehicle and the top up with an unobstructed view of the sky in all directions.

Figure 6: SMART7 orientation

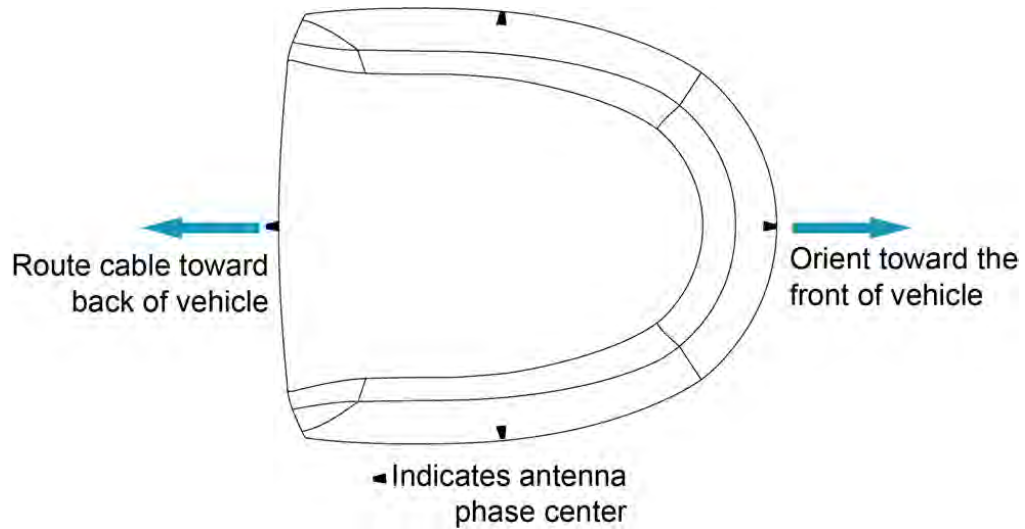

### 2.2.3 SMART7 mounting hole locations

The SMART7 mounting hole locations are shown in the following diagram.

Figure 7: SMART7 and SMART6 mounting hole locations

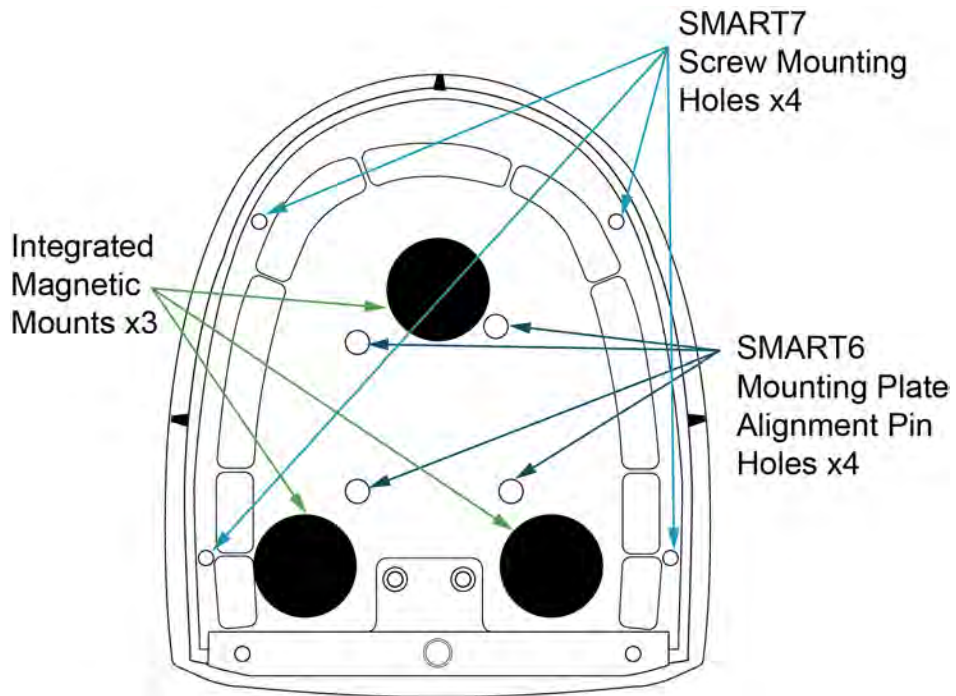

### 2.2.4 Mounting plate

An optional SMART7 mounting plate is available to facilitate mounting the SMART7. Refer to *SMART7 mounting plate specifications* on page 164 for plate dimensions and mounting hole locations.

To install the mounting plate:

1. Place the SMART7 on the SMART7 mounting plate. The alignment pins on the mounting plate seat in the SMART6 alignment pin holes.

**Figure 8: SMART7 mounting plate**

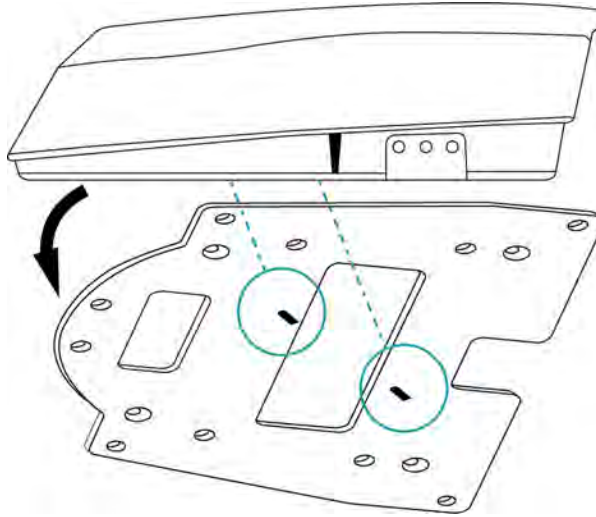

2. The integrated magnets will hold the SMART7 on to the mounting plate. To further secure the SMART7 to the mounting plate, use four M4X0.7 thread X 12 mm length screws that pass through the mounting plate and into the SMART7 screw mounting holes. Torque the screws to 10 – 12 in-lbs.
3. Attach the mounting plate to the vehicle using screws through the mounting holes at each corner of the plate or using adhesive tape. Typically, attaching the mounting plate to the vehicle using adhesive tape is only used when SMART7 is magnetically mounted to the mounting plate.

## 2.3 Connect the SMART7 to data communication equipment

The SMART7 can communicate with other devices in the system, such as computers serial, Wi-Fi or Ethernet ports. The SMART7 also has a CAN bus port for communication with other CAN bus compatible devices.



Wi-Fi and Ethernet are model dependent.

### 2.3.1 Serial ports

The SMART7 has three RS-232 serial ports: COM1, COM2 and COM3. These ports are available on the 14-pin Tyco Ampseal connector. Refer to *Table 2: SMART7 connector pinout* on page 22 for the pin out of this connector.

Port settings (bit rate and parity, for example) are software configurable. See *Communications with the receiver* on page 35 for information about configuring the serial ports. Also see *SMART7 data communication specifications* on page 159 for the serial port specifications.

To connect to a serial port:

1. Connect the SMART7 Interface cable (PN: 01019944), or a custom made cable, to the 14-pin Tyco Ampseal connector.
2. Connect the appropriate DB9 connector (COM1, COM2 or COM3) to the serial port on the computer or other data communication device.

### 2.3.2 Wi-Fi

The SMART7 has a Wi-Fi Access Point that is enabled by default. This provides for easy connection to any laptop/tablet/smartphone with Wi-Fi capability and a web browser.

1. Once the receiver is installed and powered, use a Wi-Fi capable laptop/tablet/smartphone to locate the SMART7 in the list of detected Wi-Fi Networks and establish a connection.

The SMART7 PSN of the receiver (SSID) is printed on a label located by the connector. The format of the PSN is *SMART7-<Receiver PSN>*, e.g. "SMART7-ABCDEF1234567".

2. When first connecting via Wi-Fi, the security key must be entered. The default security key is printed on a label on the bottom of the SMART7. The default security key is specific to that SMART7 receiver.



*Windows users:* Note that your Wi-Fi security key is not a PIN. If you see an option such as *Connect using a security key instead*, you must click this option to enter your security key.

3. Open up a web browser and enter **192.168.19.1**. NovAtel Manage Web, a configuration and monitoring interface hosted on the SMART7, opens.



Manage Web is compatible with recent versions of Chrome, Firefox, Internet Explorer and Safari.



**Cookies should always be on and never blocked on the browser being used to connect to the Wi-Fi network.**

For more information about using the Manage Web, refer to [docs.novatel.com/Tools/Content/Manage\\_Web/Overview.htm](https://docs.novatel.com/Tools/Content/Manage_Web/Overview.htm).

To change the configuration of the Wi-Fi interface, including password, refer to *Wi-Fi configuration* on page 93.

### 2.3.3 Ethernet port

The SMART7 has an M12 D-code (female) socket that supports 10Base-T/100Base-TX Ethernet for communications with external data communications equipment such as computers and data loggers. Refer to *Table 3: Ethernet connector pinout* on page 23 for the pin out of this connector.

The Ethernet port supports IPv4 Internet layer, TCP/IP transport, ping and connection from a Telnet client. Users can conduct remote debugging, accept MRTCA (modified RTCA) data and download firmware. OEM7 receivers are also equipped with NTRIP Version 2.0 (Networked Transport of RTCM via Internet Protocol) client and server capability.

Refer to *Ethernet configuration* on page 102 for instructions on configuring Ethernet.

### 2.3.4 CAN bus port

The SMART7 has a CAN Bus port available on the 14-Pin interface connector.

To connect to the CAN Bus port:

1. Connect the SMART7 optional accessory cable or a custom made cable, to the main 14-Pin interface connector.

For information about the SMART7 interface cable, see *SMART Antenna interface cable (optional accessory)* on page 161. This section also has the connector pin out and connector recommendations for making a custom cable.

2. Connect the CAN to the CAN Bus (J5) of the SMART7 interface cable, see *SMART Antenna interface cable (optional accessory)* on page 161.



The SMART7 CAN bus port is unterminated. If the SMART7 is at the end of the bus, then the connecting cable must have 120 ohms integrated into the cable between CAN1+ and CAN1- in close proximity to the main 14-Pin interface connector.

## 2.4 Connect I/O signals to a SMART7

The SMART7 has several outputs, also referred to as strobes, that provide status and synchronization signals.

- Pulse Per Second (PPS) output (E2 on SMART Antenna Interface cable)
- Emulated Radar Output (E2 on SMART Antenna Interface cable)

To access the I/O signals, connect the interface cable or a custom made cable, to the main 14-Pin interface connector. Refer to *SMART Antenna interface cable (optional accessory)* on page 161 for connector pin out and other details.

## 2.5 Connect power to the SMART7

To connect power to the SMART7:

1. Connect the SMART7 Interface Cable (01019944) to the 14-Pin connector on the back of the SMART7. See *SMART Antenna interface cable (optional accessory)* on page 161 for information about this cable.
2. Install a 5 A fuse between the BATT+ bare wire of the interface cable and the positive side of a +7 to +30 VDC power supply.

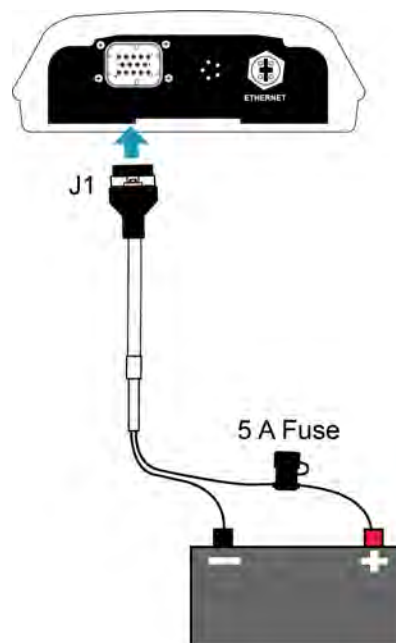

3. Connect the BATT- bare wires of the interface cable to the negative side of the power supply.

For details about the power supply required, see *Power supply requirements for the SMART7* on the next page.

### 2.5.1 Fuse for the power supply

Install a user supplied 5 A slow blow fuse in the positive line of the connection to the power source to protect the power supply wiring and your warranty.

**Table 8: SMART antenna recommended fuse and fuse holders**

Fuse	Recommended fuse/fuse holder		
12 V System Fuse (standard size blade)	ATO Silver Blade Fuse 5 A (32 V) or equivalent	Littelfuse	0287005
12 V System Fuse (mini size blade)	Mini Blade Fuse 5 A (32 V) or equivalent	Littelfuse	0297005
24 V System Fuse High Reliability, Harsh Environment (standard size blade)	FKS ATO Blade Fuse 5A (80 V) or equivalent	Littelfuse	166.7000.450
Inline Fuse Holder, (for standard size blade)	Waterproof ATO Fuse Holder	Littelfuse	FHAC0001
Inline Fuse Holder, (for mini size blade)	Waterproof Mini Fuse Holder	Littelfuse	0FHM0001



The *SMART antenna recommended fuse and fuse holders* table details the part numbers for recommended fuses and fuse holders. These numbers are provided for information only and are not available from NovAtel as separate parts.

### 2.5.2 Power supply requirements for the SMART7

The SMART7 requires a power supply that provides:

- a voltage in the range of +7 to +30 VDC
- at least 15 W of power (typical use: 3 W to 7 W)

See *SMART7 environmental and electrical specifications* on page 158 for more power supply specifications.

The SMART7 has an internal power module that:

- filters and regulates the supply voltage
- protects against over-voltage, over-current and high-temperature conditions
- provides automatic reset circuit protection

If the voltage supplied is below the minimum specification, the receiver suspends operation. If the voltage supplied is above the maximum specification, the receiver may be permanently damaged, voiding the warranty.

The supply must be capable of providing enough current to operate the SMART7, including the initial inrush transient. The supply must also be current limited to 5 A with an external fuse.



The amount of power required depends on the number of constellations and signals tracked, and the features enabled.

Refer to *SMART Antenna interface cable (optional accessory)* on page 161 for details about the power cable.

## 2.6 Check that the SMART7 is working

After the SMART Antenna is installed and powered up, use the following procedure to ensure the receiver is operating.

1. Check that the Status LED  has changed from red to yellow or green.

The Status LED may briefly flash as Red before moving quickly to the Fast Flash Yellow.

See *SMART7 LEDs* on page 23 for the location of the LEDs.

2. Connect the SMART7 to a computer using a serial cable.
3. Open **NovAtel Application Suite**, establish a connection to the SMART7 and open the *Terminal* window.  
Alternately, open a terminal emulation program and establish a connection to the SMART7.



For information about installing and using NovAtel Application Suite, refer to [docs.novatel.com/Tools/Content/ToolsSuite/Overview.htm](https://docs.novatel.com/Tools/Content/ToolsSuite/Overview.htm).

4. Send the following command:

```
LOG VERSION
```

The VERSION log is returned.

```
[COM1]<VERSION COM1 0 92.5 FINESTEERING 0 6.784 02440000 3681 15089
< 8
< GPSCARD "DDNRNNTBN" "BMHR18040357C" "OEM7700-1.01"
"OA7CR0501RN0000" "OM7BR0002RB0000" "2018/Sep/20" "05:37:06"
< OEM7FPGA "" "" "" "OMV070001RN0000" "" "" ""
< APPLICATION "" "" "" "ES7AR0501RN0000" "" "2018/Sep/20"
"05:37:19"
< DEFAULT_CONFIG "" "" "" "ES7CR0501RN0000" "" "2018/Sep/20"
"05:37:29"
< PACKAGE "" "" "" "ES7PR0501RN0000" "" "2018/Sep/20" "05:37:24"
< DB_WWWISO "WWWISO" "0" "" "WMC010204RN0001" "" "2018/Sep/26"
"10:07:36"
< ENCLOSURE "" "NMPY18070006T" "0.0.0.0" "" "" "" ""
```

< REGULATORY "US" "" "" "" "" "" "" ""



The Log version output will vary depending on SMART Antenna hardware option.

5. Check that the Time Status is **FINESTEERING** which represents that time is fine set and being steered.
6. Check the Receiver Status word (02440000 in this example). If the lowest bit (bit 0) is set, the receiver has errors.



For information about the other digits in Receiver Status word, refer to the **RXSTATUS** log in the [OEM7 Commands and Logs Reference Manual](#).

## Chapter 3 SMART7 operation

---

Before operating the receiver for the first time, refer to *SMART7 installation* on page 26 for SMART7 installation instructions.

### 3.1 Communications with the receiver

Communication is established with the receiver using a data terminal or computer connected to the receiver by a variety of methods:

- *Wi-Fi communications* below
- *Serial port communications* below
- *Ethernet communications* on page 37
- *ICOM communications* on page 37
- *CAN bus communications* on page 38

When connected to the receiver, enter commands directly from a terminal or through terminal emulation software on a computer. For example:

- **NovAtel Manage Web** - NovAtel Manage Web is a browser based tool used to monitor, configure and update a variety of receiver functions. For information about using Manage Web, refer to the online documentation ([docs.novatel.com/Tools](https://docs.novatel.com/Tools)).
- **NovAtel Application Suite** - NovAtel Application Suite is set of computer based applications that simplify the configuration and monitoring of NovAtel receivers. For information about installing and using NovAtel Application Suite, refer to the online documentation ([docs.novatel.com/Tools](https://docs.novatel.com/Tools)).
- Any console/command line application

To maximize the application of the receiver's capabilities, become familiar with the commands and logs described in the [OEM7 Commands and Logs Reference Manual](#).

#### 3.1.1 Wi-Fi communications

Wi-Fi capable receivers are configured to run a 2.4 GHz 802.11 Access Point (AP) by default. The AP starts automatically when the receiver is powered on; no explicit configuration is required.

Establish a connection between the receiver and a Wi-Fi network by locating the receiver in the list of detected Wi-Fi devices. Once detected, it is easy to connect to any laptop, tablet or smartphone with Wi-Fi capability and a web browser.

Refer to the *Wi-Fi* on page 30 section in *Connect the SMART7 to data communication equipment* on page 29 for instructions on starting a Wi-Fi connection to the SMART7-I or SMART7-W.

To change the configuration of the Wi-Fi interface, including password, refer to *Wi-Fi configuration* on page 93.

#### 3.1.2 Serial port communications

The receiver can communicate with a computer or terminal via a serial port. For communication to occur, both the receiver and the operator interface have to be configured properly. The receiver's default port settings are:

- 9600 bps
- no parity
- 8 data bits

- 1 stop bit
- no handshaking
- echo off
- break on

The data transfer rate determines how fast information is transmitted. Take for example a log whose message byte count is 96. The default port settings allows 10 bits/byte (8 data bits + 1 stop bit + 1 framing bit). It therefore takes 960 bits per message. To get 10 messages per second then requires 9600 bps. Also remember that even if you set the bps to 9600, the actual data transfer rate may be lower and depends on the number of satellites being tracked, data filters in use, and idle time. It is therefore suggested that you leave yourself a margin when choosing a data rate.



The minimum suggested baud rate for most applications is 115200 bps for GNSS only or 230400 bps for GNSS+INS. If the buffer overrun flag is present in the **RXSTATUS** log (refer to the [OEM7 Commands and Logs Reference Manual](#)), log at a higher baud rate if possible, or change to a medium supporting higher bandwidth (Ethernet).

**Although the receiver can operate at data transfer rates as low as 300 bps, this is not recommended. For example, if several data logs are active (that is, a significant amount of information needs to be transmitted every second) but the bit rate is set too low, data overflows the serial port buffers, causing an error condition in the receiver status that results in lost data.**

The following ports are supported and can be configured using the commands listed. Refer to the commands listed in the [OEM7 Commands and Logs Reference Manual](#) for detailed instructions.

**Table 9: Serial ports supported**

Receiver type	Port supported	Configuration command
SMART7	COM1, COM2, COM3	SERIALCONFIG

### Change the COM port settings

To change the settings on a COM port, use the **SERIALCONFIG** command. For example:

- To change the data rate of COM2 to 115200, enter:

```
SERIALCONFIG COM2 115200
```

- To change the data rate of COM1 to 57600 and enable even parity, enter:

```
SERIALCONFIG COM1 57600 E
```

### Communicating using a remote terminal

One method of communicating with the receiver is through a remote terminal. To communicate with the terminal, the receiver requires only the RX, TX and GND lines be used. Ensure the terminal's communications set up matches the receiver's port settings.

## Communicating using a computer

A computer can emulate a remote terminal as well as provide the added flexibility of supporting multiple command batch files and data logging storage files. Use any standard communications software package that emulates a terminal to establish bidirectional communications with the receiver. Examples include NovAtel Application Suite and PuTTY. All data is sent as raw 8-bit binary or ASCII characters.

Refer to *Communicating with the receiver* on the next page for details.

### 3.1.3 Ethernet communications

The SMART7-I and SMART7-SI are equipped with a 10-Base-T/100-Base-TX Ethernet port that supports IPv4 Internet layer, TCP/IP transport and telnet. Users can conduct remote debugging, accept MRTCA (modified RTCA) data and update firmware. OEM7 receivers are also equipped with NTRIP Version 2.0 (Networked Transport of RTCM via Internet Protocol) client and server capability.

The Ethernet port must be configured before using. Refer to *Ethernet configuration* on page 102 for configuration details.



**The Ethernet ports are Safety Extra-Low Voltage (SELV) circuits only and are suitable for connection within a building only. Do not connect them to Telephone Network Voltage (TNV) circuits.**

**If intra-building connections are required, or the OEM7 receiver is installed in an outdoor enclosure, a suitably rated Ethernet router or switch should be installed between the receiver Ethernet port and the network connection.**



Issue the **SAVEETHERNETDATA ETHA** command to ensure port settings are retained after a reset and automatically used at boot time. The **SAVEETHERNETDATA ETHA** command is not applicable to the **ICOMCONFIG** and **NTRIPCONFIG** command settings. The **SAVEETHERNETDATA ETHA** command takes precedence over the **SAVECONFIG** command configuration.

### 3.1.4 ICOM communications

ICOM ports are virtual ports used for Ethernet or Wi-Fi connections. The transport/application layer of the ICOM ports can be configured to use Transmission Control Protocol (TCP) for internet IP or User Datagram Protocol (UDP) a slower and less reliable IP protocol.

Refer to **DNSCONFIG** command for Ethernet DNS configuration. If using DHCP, DNS is automatically set.

The following are the default ICOM configurations:

- ICOMCONFIG ICOM1 TCP :3001
- ICOMCONFIG ICOM2 TCP :3002
- ICOMCONFIG ICOM3 TCP :3003
- ICOMCONFIG ICOM4 TCP :3004
- ICOMCONFIG ICOM5 TCP :3005
- ICOMCONFIG ICOM6 TCP :3006
- ICOMCONFIG ICOM7 TCP :3007

Each ICOM port can act as a server (waiting for an external connection to be made) or as a client (actively establishing a connection to a specific port).

For details on the ICOM port commands, refer to **IPCONFIG** command, **ICOMCONFIG** command and **ETHCONFIG** command in the [OEM7 Commands and Logs Reference Manual](#).

### 3.1.5 CAN bus communications

The SMART7 has one CAN port. This CAN port supports data rates up to 1 Mbps.

The SMART7 supports J1939 and NMEA2000 CAN protocols. For information about configuring the CAN ports to use J1939 or NMEA200 protocols, refer to *CAN bus* on page 111.

The SMART7 can also write messages to and read messages from the CAN bus using OEM7 commands and logs. This is typically implemented using the NovAtel API. For more information refer to Using Lua to Access I/O Devices Connected to the Receiver in the *OEM7 NovAtel API User Manual*.



The SMART7 has internal CAN transceivers, however it still requires proper bus terminations.

## 3.2 Getting started

The receiver's software resides in flash memory. When first powered, it undergoes a complete self-test. If an error condition is detected during the self-test, the status word changes. This self-test status word can be viewed in the header of any data output log. Refer to Messages in the [OEM7 Commands and Logs Reference Manual](#) for header information. If a persistent error occurs, contact your local NovAtel dealer. If the dealer cannot resolve the problem, contact NovAtel Customer Support directly using one of the methods listed in *Customer Support* on page 17.

### 3.2.1 Communicating with the receiver

You can communicate with the receiver using NovAtel Manage Web, NovAtel Application Suite or a terminal emulation program.



For instructions on using NovAtel Manage Web and NovAtel Application Suite, refer to [docs.novatel.com/Tools](https://docs.novatel.com/Tools).

When the receiver is first turned on, no data is transmitted from the COM ports except for the port prompt.

Any of the COM port prompts indicate that the receiver is ready and waiting for command input. The screen may display other port names for other port types.



1. Output from receiver self-tests may take some time. On startup, the receiver is set to log the RXSTATUSEVENTA log ONNEW on all ports. See *RXSTATUSEVENT log* on page 118 for more details.
2. If NovAtel Application Suite is unable to locate the receiver, use a different COM port to communicate with the receiver. When communication has been established, issue a **FRESET STANDARD** command. The original communications port should be ready for use. See the **FRESET** command for more information.

An example of a response to an input **LOG** command:

```
[COM2] LOG COM1 BESTPOS ONTIME 1
```

```
<OK
```

In this example, [COM2] is the port prompt.

If the command was accepted, the receiver responds with:

<OK

If a command is entered incorrectly, the receiver responds with:

<ERROR:Invalid Message ID (or a more detailed message)



**Ensure the computer does not sleep or hibernate during a logging session or data will be lost.**

### 3.3 Transmitting and receiving corrections

Corrections can be transmitted from a base station to a rover station to improve position accuracy. The base station is the GNSS receiver that acts as the stationary reference. The stationary reference has a known position and transmits correction messages to the rover station. The rover station is the GNSS receiver that does not know its exact position and requires correction messages from a base station to calculate differential GNSS positions. An example of a differential setup is shown in *Figure 9: Basic differential setup* on the next page.

Figure 9: Basic differential setup

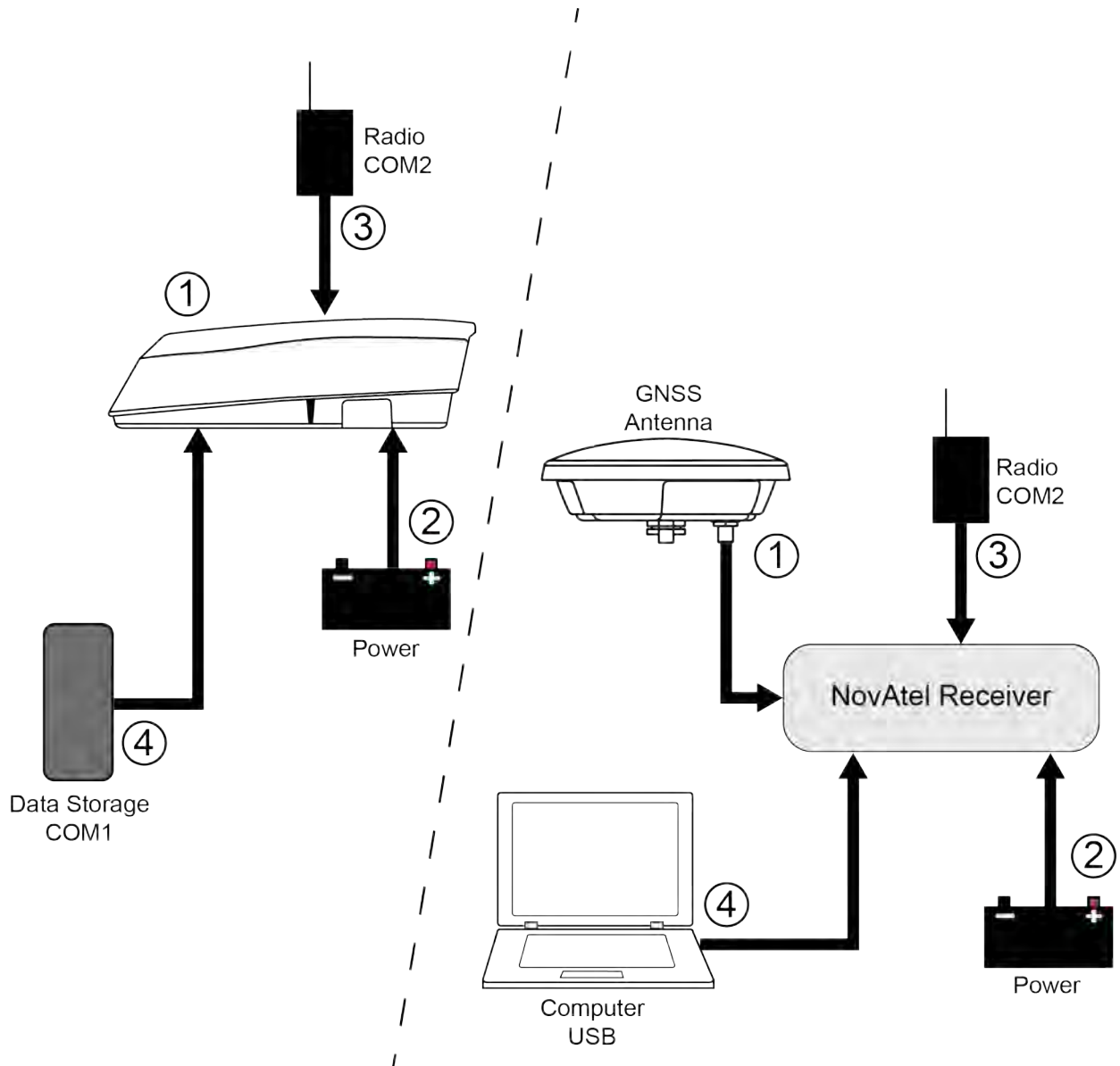
**Rover Setup**

- 1 Mount the SMART7
- 2 Connect a fused power supply (user supplied)
- 3 Connect a radio device to COM2 (user supplied)
- 4 Connect a storage device to COM1 (user supplied)

**Base Setup**

- 1 Mount and connect a GNSS antenna
- 2 Connect a fused power supply (user supplied)
- 3 Connect a radio device to COM2 (user supplied)
- 4 Connect a computer to COM1 for setup and monitoring (user supplied)

To receive corrections, a data link between the base station and the rover station is required. The base and rover stations can both be NovAtel receivers, however NovAtel receivers will work with some other brands. Contact Customer Support for further details (refer to *Customer Support* on page 17 for details).

The data link should support a rate of at least 19200 bits per second, but a rate of 115200 bits per second, with less than 4.0 s latency, is recommended.



Unlike the base/rover concept, SBAS and PPP corrections can be applied directly to a single receiver.

When the base and rover are set up, configure them as shown in the configuration examples in *Base station configuration* below and *Rover station configuration* on the next page.

### 3.3.1 Defining antenna and base antenna

The type of antenna for the receiver and/or the base receiver can be defined using the **THISANTENNATYPE** command and **BASEANTENNATYPE** command respectively.

The Phase Center Variation (PCV) and the Phase Center Offset (PCO) for each can also be specified using the **THISANTENNAPCV** command and **THISANTENNAPCO** command or the **BASEANTENNAPCV** command and **BASEANTENNAPCO** command.

Refer to the [OEM7 Commands and Logs Reference Manual](#) for command details.

### 3.3.2 Base station configuration

At the base station, enter the following commands:

```
serialconfig [port] baud [parity[databits[stopbits[handshaking[break]]]]]
interfacemode port rx_type tx_type [responses]
fix position latitude longitude height (enter your own lat, long and hgt values)
log port message [trigger [period]] (port = COM2 / refer to Figure 9: Basic differential setup
on the previous page)
saveconfig (optional)
```

The following sections are examples of base station configurations.

#### RTK Automated Correction Generation

```
fix position lat lon hgt (enter your own lat, lon, hgt)
generatertkcorrections rtcmv3 com2
```

#### RTCM V3

```
serialconfig com2 19200 N 8 1 N on
interfacemode com2 none rtcmv3 off
fix position lat lon hgt (enter your own lat, lon, hgt)
log com2 rtcml1004 ontime 1
log com2 rtcml1006 ontime 10
log com2 rtcml1019 ontime 120
saveconfig (optional)
```

**RTCM V3 with GLONASS**

```

serialconfig com2 19200 N 8 1 N on
interfacemode com2 none rtcmv3 off
fix position lat lon hgt (enter your own lat, lon, hgt)
log com2 rtcm1004 ontime 1
log com2 rtcm1012 ontime 1
log com2 rtcm1006 ontime 10
log com2 rtcm1033 ontime 10
log com2 rtcm1019 ontime 120
log com2 rtcm1020 ontime 120
saveconfig (optional)

```

**NOVATELX**

```

serialconfig com2 19200 N 8 1 N on
interfacemode com2 none novatelx off
fix position lat lon hgt (enter your own lat, lon, hgt)
log com2 novatelxobs ontime 1
saveconfig (optional)

```



For more information, refer to the **FIX** command, **INTERFACEMODE** command, **SAVECONFIG** command and **SERIALCONFIG** command in the [OEM7 Commands and Logs Reference Manual](#).

**3.3.3 Rover station configuration**

At the rover station, enter the following commands:

```

serialconfig [port] baud [parity[ databits [stopbits [handshaking [break]]]]]
interfacemode port rx_type tx_type [responses]
saveconfig (optional)

```

The following sections are examples of rover configurations, if COM2 was connected to the correction source.

**RTK automated correction detection**

```

serialconfig com2 19200 N 8 1 N on
interfacemode com2 auto none off
saveconfig (optional)

```

**RTCM V3**

```

serialconfig com2 19200 N 8 1 N on
interfacemode com2 rtcmv3 none off
saveconfig (optional)

```

**RTCM V3 with GLONASS**

```
serialconfig com2 19200 N 8 1 N on
interfacemode com2 rtcmv3 none off
saveconfig (optional)
```

**NOVATELX**

```
serialconfig com2 19200 N 8 1 N on
interfacemode com2 NOVATELX none off
saveconfig (optional)
```



For more information, refer to the **INTERFACEMODE** command, **SAVECONFIG** command and **SERIALCONFIG** command in the [OEM7 Commands and Logs Reference Manual](#).

**3.3.4 Configuration notes**

For compatibility with other GNSS receivers and to minimize message size, use the standard form of RTCMV3 corrections shown in the base and rover examples in *Transmitting and receiving corrections* on page 39. This requires using the **INTERFACEMODE** command to dedicate one direction of a serial port to one message type only. When the **INTERFACEMODE** command is used to change the mode from the NOVATEL default, the NovAtel format messages can no longer be used.

To mix NovAtel format messages and RTCM V3 messages on the same port, leave the interface mode set to NOVATEL and log out variants of the standard correction messages with a NovAtel header. ASCII or binary variants can be requested by appending an A or B to the standard message name. For example, on the base station:

```
interfacemode com2 novatel novatel
fix position 51.11358042 -114.04358013 1059.4105
log com2 rtcml004b ontime 2
```



1. Interface mode must be set to NOVATEL for the receiver to issue logs with an A or B suffix.
2. Using the receiver in NOVATEL mode consumes more CPU bandwidth than using the native differential messages as shown in *Base station configuration* on page 41.
3. To find information on how to send multiple commands and log requests from a computer, search our knowledge database available at [novatel.com/support](http://novatel.com/support).

At the rover, leave the interface mode default settings (interfacemode com2 novatel novatel). The rover recognizes the default and uses the corrections it receives with a NovAtel header.

The **PSRDIFFSOURCE** command and **RTKSOURCE** command set the station ID values that identify the base stations from which to accept pseudorange or RTK corrections. They are useful commands when the rover station is receiving corrections from multiple base stations.

**3.4 ALIGN Heading base and remote configurations**

ALIGN technology combines two or more receivers to generate high precision heading and pitch angles between two receivers for real-time navigation.

This section provides instructions for setting up a base station with an ALIGN capable rover receiver for applications that require heading output.

**This section is intended for systems that do not use SPAN. If SPAN is used on the system, refer to the configuration in SPAN with Dual Antenna available at [docs.novatel.com/OEM7](https://docs.novatel.com/OEM7).**

### 3.4.1 Automatic set up for direct-wire connection between base and rover via COM2

The **ALIGNAUTOMATION** command must only be sent to the rover.

```
ALIGNAUTOMATION ENABLE
```

or

```
ALIGNAUTOMATION ENABLE COM2 230400 10 ON
```

### 3.4.2 Manual set up via COM2

#### Base:

```
serialconfig com2 230400 N 8 1 N on
interfacemode com2 novatel novatelx off
movingbasestation enable
log com2 novatelxobs ontime 1
log com2 novatelxref ontime 1
log heading2a onnew
log gphdt onchanged
```

#### Rover:

```
serialconfig com2 230400 N 8 1 N on
interfacemode com2 novatelx novatel off
rtkportmode com2 ALIGN
log com2 headingext2b onnew
log heading2a onnew
log gphdt onchanged
hdtoutthreshold 1.0
```

## 3.5 GLIDE

NovAtel's GLIDE is a positioning algorithm for single-frequency GPS and GPS/GLONASS applications. GLIDE produces a smooth position output tuned for applications where time relative accuracy (pass-to-pass) is more important than absolute accuracy. Because of this, it is well suited for agricultural applications.

Multipath signals tend to induce time varying biases and increase the measurement noise on the L1/L2 pseudorange measurements. Carrier phase measurements are much less susceptible to the effects of multipath. The GLIDE algorithm fuses the information from the L1 code and the L1 phase measurements into a Position Velocity Time (PVT) solution.

GLIDE includes settings for a dynamic mode, a static mode and an “auto” mode, where the filtering parameters are automatically adjusted as vehicle velocity varies between stationary and dynamic states.

### 3.5.1 Dual-frequency GLIDE

NovAtel's dual-frequency GLIDE technology adds to the superior pass-to-pass performance provided by single-frequency GLIDE. Dual-frequency GLIDE is ideal for agricultural and machine guidance applications where relative positioning is critical. Using GLIDE significantly reduces the variation in position errors to less than 1 cm from one epoch to the next. Dual-frequency GLIDE improves the absolute accuracy of the GLIDE position and creates a robust solution resistant to the effects of high ionospheric activity. GLIDE works in all code positioning modes, including single point, DGNSS and SBAS.

Refer to the NovAtel white paper on [GLIDE Technology](#) for more information on GLIDE and [APN-038: Pseudorange/Delta-Phase \(PDP\) and GLIDE Filters](#) along with other information available from [novatel.com/support/support-materials/application-notes](http://novatel.com/support/support-materials/application-notes).

### 3.5.2 PDP and GLIDE configurations

GLIDE is a mode of the Pseudorange/Delta-Phase (PDP) position filters. PDP and GLIDE can be used for single-frequency single point, WAAS or DGNSS positioning. Refer to the **PDPFILTER** command and **PDPMODE** command in the [OEM7 Commands and Logs Reference Manual](#).

To reset the PDP or GLIDE filter:

```
pdpfilter reset
```

To enable the PDP filter:

```
pdpfilter enable
```

Ensure the **PDPFILTER** command is used before the **PDPMODE** command. Set the PDP type and kinematic type according to the application. For most kinematic applications:

```
pdpmode glide dynamic or pdpmode glide auto
```

The rest of the setup is position type and log dependent according to the application. See **PSRDIFFSOURCE** command, **INTERFACEMODE** command and **SERIALCONFIG** command in the [OEM7 Commands and Logs Reference Manual](#) for details.. Also refer to the NovAtel application note [APN-038: Pseudorange/Delta-Phase \(PDP\) and GLIDE Filters](#) available from our web site at [novatel.com/support/support-materials/application-notes](http://novatel.com/support/support-materials/application-notes).

## 3.6 STEADYLINE

The STEADYLINE functionality helps mitigate the discontinuities that often occur when the receiver changes GNSS positioning modes. The effect is especially evident when a receiver transitions from an RTK position mode solution to a lower accuracy “fall back” solution, such as DGPS, WAAS+GLIDE or even autonomous GLIDE (see *Figure 10: Positioning Change Without STEADYLINE* below). Smooth transitions are particularly important for agricultural steering applications where sudden jumps are problematic.

**Figure 10: Positioning Change Without STEADYLINE**

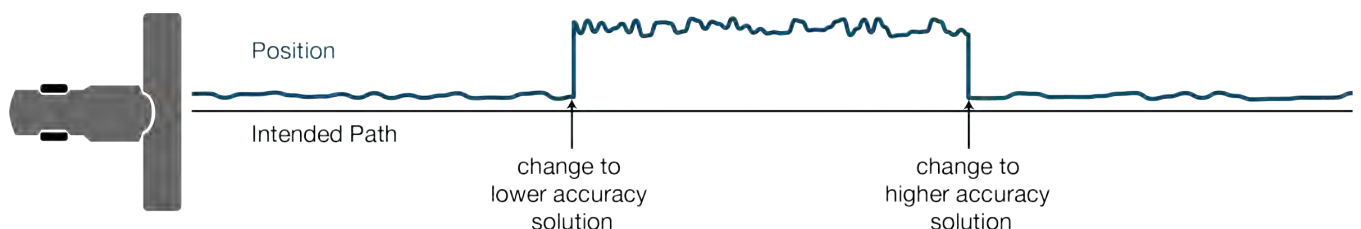

The STEADYLINE feature internally monitors the position offsets between all the GNSS positioning modes present in the receiver. When the current positioning mode becomes unavailable, the receiver transitions to the next most accurate positioning mode.



Refer to the [OEM7 Commands and Logs Reference Manual](#) for log and command details.

### 3.6.1 Prefer Accuracy

The positioning mode change depends on the accuracy level of the positioning modes.

When the position mode is changing from a more accurate mode to a less accurate mode (e.g., changing from RTK to GLIDE), the receiver uses the position offset calculated to limit a potential real position jump.

When the position mode is changing from a less accurate mode to a more accurate mode (e.g., GLIDE to RTK), the receiver slowly transitions to the new reference position type over the time period specified by the Transition time parameter.

For example, a receiver is configured to do both RTK and GLIDE. If this receiver has a fixed RTK position and experiences a loss of correction data causing the loss of the RTK solution it will immediately apply the offset between the two position modes and uses the GLIDE position stability to maintain the previous trajectory. Over time the GLIDE (or non-RTK) position will experience some drift. Once the RTK position is achieved again the receiver will start using the RTK positions for position stability and will slowly transition back to the RTK positions at a default rate of 0.005 m/s or the time specified in the **STEADYLINE** command.

Figure 11: STEADYLINE Prefer Accuracy

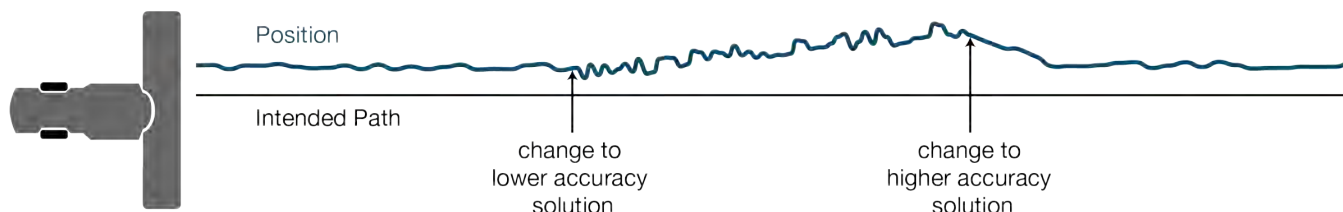

## 3.7 Enabling SBAS positioning

OEM7 receivers are capable of SBAS positioning. This positioning mode is enabled using the **SBASCONTROL** command:

```
sbascontrol enable auto
```

When the command is entered, the OEM7 receiver automatically tracks the SBAS that is operating in the region (e.g., WAAS or EGNOS) and applies the corrections from the service. On a simulator, leave the test mode parameter off or specify NONE explicitly. For more on SBAS, refer to application note [APN-051 Positioning Modes of Operation](#) (additional Application Notes available at [novatel.com/support/support-materials/application-notes](http://novatel.com/support/support-materials/application-notes)) and the known solution [SBAS Positioning](#).

## 3.8 TerraStar Correction Services

With TerraStar Correction Services data and NovAtel's Precise Point Positioning (PPP) algorithm, SMART7 receivers can achieve up to centimetre level positioning accuracy when a TerraStar subscription is active.

To use TerraStar Correction Services and obtain a PPP solution, perform the following steps.

1. Ensure the GNSS system has the required components. See *Required components* below.
2. Ensure the OEM7 receiver has a model that supports the TerraStar Correction Service to be used. See *Receiver models needed for TerraStar Correction Services* below.
3. Enable L-Band tracking on the receiver.  
L-band tracking is enabled by default and required for service delivery unless IP service delivery is used. See *Enable L-Band tracking* on the next page.
4. Obtain a subscription to the TerraStar Correction Service to be used. See *TerraStar subscriptions* on page 49.

### 3.8.1 Required components

To use TerraStar Correction Services, the GNSS system requires the following components:

- A SMART7
- Receiver firmware that is compatible with TerraStar Correction Services.
  - TerraStar-L – all OEM7 firmware versions
  - TerraStar-C PRO – firmware version 7.05.00 or later
  - TerraStar-X Regional – firmware version 7.06.03 or later



Firmware version 7.08.10 or later is required for the best convergence performance for TerraStar-C PRO and for use of TerraStar-X when the receiver is outside of the region.

For instructions on upgrading the OEM7 receiver firmware, see *NovAtel firmware* on page 131.

### 3.8.2 Receiver models needed for TerraStar Correction Services

Specific receiver models are required to use the correction data provided by TerraStar Correction Services.

To check the model of the receiver:

1. Request the **VERSION** log to view the current receiver model.

```
log version once

<VERSION USB1 0 57.0 FINESTEERING 2232 422240.766 02000020 3681 16809
< 11
< GPSCARD "FFNRNNCBES1" "BMHR17090005E" "OEM7700-1.00"
"OM7CR0810RN0000" "OM7BR0001RBG000" "2021/Dec/06" "11:16:48"
< OEM7FPGA "" "" "" "OMV070001RN0000" "" "" ""
< APPLICATION "" "" "" "EP7AR0810RN0000" "" "2021/Dec/06" "11:16:59"
< DEFAULT_CONFIG "" "" "" "EP7CR0810RN0000" "" "2021/Dec/06"
"11:17:11"
< PACKAGE "" "" "" "EP7PR0810RN0000" "" "2021/Dec/06" "11:17:05"
< DB_WWWISO "WWWISO" "0" "" "1.8.0" "" "2022/Apr/11" "15:44:16"
< ENCLOSURE "PWRPAK7-E1" "NMNE17200009B" "" "" "" ""
< WIFI "RS9113" "" "" "1.7.12" "" "2021/Dec/06" "11:17:22"
< REGULATORY "US" "" "" "" "" ""
< IMUCARD "Epson G320N 125" "00000354" "G320PDGN" "2510" "" "" ""
< WHEELSENSOR "" "" "" "SWS000201RN0000" "" "" ""
```

2. Compare the model number of the receiver to the model required for a TerraStar subscription. The first four letters of the receiver model must match the letters in the table below.  
In the example above, the receiver model number is **FFNRNNCBES1**.

		TerraStar-L	TerraStar-C PRO	TerraStar-X	RTK ASSIST	RTK ASSIST PRO
SMART7	Minimum model required	GDN-L	DDN-P	DDN-R	DDN-R	DDN-R
	Model for full functionality	DDN-L	FFN-P	FFN-R	DDN-R	FFN-R



Notes about the fourth letter. A **P** model (e.g. DDN-**P**) meets the requirements for L and P. An **R** model (e.g. FFN-**R**) meets the requirements for L, P and R.



Models that enable TerraStar-C PRO, TerraStar-X or RTK ASSIST PRO also enable the Subscription Managed Channel Configuration feature. For more information, see *Subscription Managed Channel Configuration* on page 50.

- If the receiver does not have the minimum model required, or if you want to upgrade to full TerraStar functionality, contact your local NovAtel sales representative to upgrade the receiver model.

### 3.8.3 Enable L-Band tracking

The receiver must be powered and tracking an L-Band signal from a TerraStar satellite prior to the planned activation time. Send the **ASSIGNLBANDBEAM** command to configure the receiver to track the L-Band signals from TerraStar satellites.

```
ASSIGNLBANDBEAM auto
```



By default, the ASSIGNLBANDBEAM command is set to AUTO on SMART7 receivers.

To confirm the receiver is tracking of an L-Band signal, request the **LBANDTRACKSTAT** log to view the L-Band tracking status information.

```
log lbandtrackstat
<LBANDTRACKSTAT USB1 0 54.5 FINESTEERING 2232 421280.000 02000020 29e3 16809
< 5
< "98W" 1545865000 1200 974c 00c2 0 -449.146 40.239 2.8709 160.522 2944 1 1
376832 287 0.0005
< "AORW" 1545845000 1200 974c 00c2 0 -178.422 44.178 4.1159 171.958 3200 0
0 409600 2 0.0000
< "POR" 1545905000 1200 974c 0000 0 643.962 0.000 0.0000 0.000 0 0 0 0 0
0.0000
< "" 0 0 0000 0003 0 0.000 0.000 0.0000 0.000 0 0 0 0 0 0.0000
< "" 0 0 0000 0003 0 0.000 0.000 0.0000 0.000 0 0 0 0 0 0.0000
```

If the receiver is tracking an L-Band signal from a TerraStar satellite, the tracking status word (shown in bold in the example above) of the LBANDTRACKSTAT log will be **00c2**. In the example above, the tracking status word indicates that the receiver has locked onto the signal from "98W" and "AORW", but not "POR".



The latest services and coverage can be obtained from [novatel.com/products/gps-gnss-correction-services/terrastar-correction-services](https://novatel.com/products/gps-gnss-correction-services/terrastar-correction-services). For additional information on TerraStar activation, contact NovAtel Customer Service at [novatel.com/support](https://novatel.com/support) or download *APN-087 TerraStar on OEM7* from [novatel.com/support/support-materials/application-notes](https://novatel.com/support/support-materials/application-notes)

### 3.8.4 TerraStar subscriptions

A subscription is required to use TerraStar Correction Services for land and airborne applications.

There are several TerraStar Correction Services available:

- **TerraStar-L**  
TerraStar-L is a real-time correction service that includes GPS and GLONASS satellite clock and orbit corrections that provides sub-metre accuracy.
- **TerraStar-C PRO**  
TerraStar-C PRO is an advanced GNSS correction service that provides additional information, including higher rate clock and orbit corrections, and makes PPP ambiguity resolution possible. TerraStar-C PRO provides centimetre-level accuracy, fast convergence and fast re-convergence after GNSS outages.
- **TerraStar-X Regional**  
TerraStar-X Regional GNSS correction technology leverages Hexagon's continuously operating global and regional reference networks for correction generation, data compression and delivery for precise, safe, reliable solutions at centimetre-level accuracy with convergence in less than one minute.
- **RTK ASSIST**  
RTK ASSIST enables OEM7 receivers to maintain centimetre-level accuracy for up to 20 minutes of RTK correction outages.
- **RTK ASSIST PRO**  
RTK ASSIST PRO enables OEM7 receivers to maintain centimetre-level accuracy for longer RTK correction outages. It also provides independent centimetre-level positioning enabling operations in areas where there is no RTK base or network coverage

For more information about TerraStar services, visit [novatel.com/products/gps-gnss-correction-services/terrastar-correction-services](https://novatel.com/products/gps-gnss-correction-services/terrastar-correction-services).

#### Obtain a subscription

To obtain a subscription, contact your local NovAtel sales representative. The NovAtel product serial number (PSN) is needed to obtain a subscription. Request the **VERSION** log to view the receiver serial number.

```
log version once
```

```
<VERSION USB1 0 57.0 FINESTEERING 2232 422240.766 02000020 3681 16809
< 11
< GPSCARD "FFNRNNCBES1" "BMHR17090005E" "OEM7700-1.00" "OM7CR0810RN0000"
"OM7BR0001RBG000" "2021/Dec/06" "11:16:48"
< OEM7FPGA "" "" "" "OMV070001RN0000" "" "" ""
< APPLICATION "" "" "" "EP7AR0810RN0000" "" "2021/Dec/06" "11:16:59"
< DEFAULT_CONFIG "" "" "" "EP7CR0810RN0000" "" "2021/Dec/06" "11:17:11"
< PACKAGE "" "" "" "EP7PR0810RN0000" "" "2021/Dec/06" "11:17:05"
< DB_WWWISO "WWWISO" "0" "" "1.8.0" "" "2022/Apr/11" "15:44:16"
< ENCLOSURE "PWRPAK7-E1" "NMNE17200009B" "" "" "" "" ""
< WIFI "RS9113" "" "" "1.7.12" "" "2021/Dec/06" "11:17:22"
< REGULATORY "US" "" "" "" "" "" ""
< IMUCARD "Epson G320N 125" "00000354" "G320PDGN" "2510" "" "" ""
```

```
< WHEELSENSOR "" "" "" "SWS000201RN0000" "" "" ""
```

In the example above, the receiver serial number is **BMHR17090005E**.

### Verify the subscription status

After a subscription is purchased, the subscription activation signal can be broadcast at the time of the service activation (default), or at a specified start date and time (upon user request).



The receiver must be configured to track the TerraStar signal prior to the subscription start time. See *Enable L-Band tracking* on page 48.

To confirm the TerraStar subscription status, request the **TERRASTARSTATUS** log:

```
log terrastarstatus
<TERRASTARSTATUS USB1 0 57.0 FINESTEERING 2232 423531.436 02000020 32bc 16809
< ENABLELOCKED 0 IN_RANGE DISABLED
```

The first field after the log header will be **ENABLE** to indicate the TerraStar subscription is valid. The second field after the log header will be **LOCKED** to indicate the decoder is locked to the data format.

To achieve full TerraStar performance, reset the receiver using the **RESET** command or by power cycling the receiver.

### Monitor PPP convergence

The PPP position calculated using TerraStar Correction Services is not ready for use until the PPP solution has converged. To monitor the PPP convergence, request the **PPPPOS** log:

```
log ppppos ontime 1
<PPPPOS USB1 0 47.5 FINESTEERING 2232 424797.000 02000020 9078 16809
< SOL_COMPUTED PPP_CONVERGING 51.15043905734 -114.03067597608 1096.6201 -
17.0001 WGS84 0.6791 0.4277 1.7640 "TSTR" 17.000 0.000 34 34 34 33 00 00 7f 37
<PPPPOS USB1 0 58.5 FINESTEERING 2232 424886.000 02000020 9078 16809
< SOL_COMPUTED PPP 51.15043767399 -114.03067692975 1097.4541 -17.0001 WGS84
0.2498 0.1951 0.4824 "TSTR" 16.000 0.000 34 34 34 33 00 00 7f 37
```

Initially the position type will report **PPP\_CONVERGING** for TerraStar-C Pro and TerraStar-X, or **PPP\_BASIC\_CONVERGING** for TerraStar-L. After the PPP solution has converged, the position type in the **PPPPOS** log will change to **PPP** for TerraStar-C PRO and TerraStar-X, or **PPP\_BASIC** for TerraStar-L.

### 3.8.5 Subscription Managed Channel Configuration

When using TerraStar-C PRO, TerraStar-X or RTK ASSIST PRO service, an all constellation, all frequency channel configuration gives better accuracy and faster convergence time compared to a dual-constellation, dual-frequency channel configuration. To allow the receiver to make best use of the TerraStar subscription, the Subscription Managed Channel Configuration (SMCC) feature automatically changes the channel configuration of the receiver to ensure all available constellations and frequencies are used. The specific channel configuration used is shown in the table below.

Receiver	TerraStar-C PRO	TerraStar-X	RTK ASSIST PRO
SMART7	FF config (7)	FF config (7)	FF config (7)



For information about channel configurations, refer to the **SELECTCHANCONFIG** command and the **CHANCONFIGLIST** log.

SMCC is enabled by default.

For information about enabling or disabling SMCC, see the **TERRASTARAUTOCHANCONFIG** command.



The automatically applied channel configuration takes effect on the next receiver restart after the TerraStar subscription is received.



If the TerraStar-X, TerraStar-C PRO or RTK ASSIST PRO subscription becomes inactive, the receiver will revert to the channel configuration enabled by the receiver model.



This feature is available on OEM firmware version 7.08.10 and later.

### 3.8.6 Additional information

For more information on TerraStar Correction Services, refer to *APN-087: TerraStar on OEM7* available from [novatel.com/support/support-materials/application-notes](http://novatel.com/support/support-materials/application-notes)

## 3.9 RTK ASSIST Services

RTK ASSIST and RTK ASSIST PRO are features that enable centimetre-level accuracies to be maintained through extended RTK correction outages. With RTK ASSIST, RTK-dependent operations can continue through RTK correction outages as long as 20 minutes. With RTK ASSIST PRO, RTK dependent operation can continue for extended RTK correction outages. RTK ASSIST PRO also enables independent centimetre-level positioning in areas where there is no RTK base or network coverage.

RTK ASSIST services use correction data provided by TerraStar. To obtain these corrections, an L-Band capable receiver is required and L-Band tracking must be enabled.

RTK ASSIST services also require a subscription to the RTK ASSIST service. To obtain a subscription, contact your local NovAtel sales representative or visit [novatel.com/products/gps-gnss-correction-services/terrestar-correction-services](http://novatel.com/products/gps-gnss-correction-services/terrestar-correction-services). The NovAtel Product Serial Number (PSN) is needed to obtain a subscription. The PSN is available from the **VERSION** log.

RTK ASSIST services are available as soon as the rover receiver has at least one valid RTK solution and has received the RTK ASSIST correction data. If an RTK correction outage occurs, then RTK ASSIST will maintain RTK mode until the subscription-permitted RTK ASSIST duration is exceeded. A shorter, user-defined RTK ASSIST time out can also be set using the **RTKASSISTTIMEOUT** command. Normal RTK operation will seamlessly resume if RTK corrections are restored at any point while RTK ASSIST is operating.

RTK ASSIST will report the RTK solution type that was present before RTK corrections were lost, unless the estimated solution standard deviation exceeds the threshold set by the **RTKINTEGGERCRITERIA** command. If this occurs, then integer RTK solutions will be downgraded to their float RTK equivalent.

RTK ASSIST is enabled by default, but can be disabled using the **RTKASSIST** command. To monitor the status of RTK ASSIST, view the **RTKASSISTSTATUS** log.

Refer to the [OEM7 Commands and Logs Reference Manual](#) for log and command details.



RTK ASSIST typically provides 4 cm accuracy. However, if the RTK outage occurs during the first 30 minutes of receiver operation, the position accuracy provided by RTK ASSIST may be lower.



Additional information about enabling and using RTK ASSIST is available in [APN-073: RTK ASSIST & RTK ASSIST PRO](#) (available from our website: [novatel.com/support/support-materials/application-notes](http://novatel.com/support/support-materials/application-notes)).

### 3.10 Terrain Compensation

The Terrain Compensation feature corrects for errors in position caused by the roll and pitch of the vehicle. The SMART Antenna senses the vehicle's roll and pitch angle and, with the user-entered "height above ground", compensates the position output to give the position under the vehicle rather than at the antenna.



Vehicle motion is required to compute and obtain terrain-compensated positions.

As shown in *Figure 12: Terrain Compensation – roll* below and *Figure 13: Terrain Compensation – pitch* on the next page, if a vehicle is operating on sloped terrain, the position will be in error by an amount proportional to the roll or pitch angles.

**Figure 12: Terrain Compensation – roll**

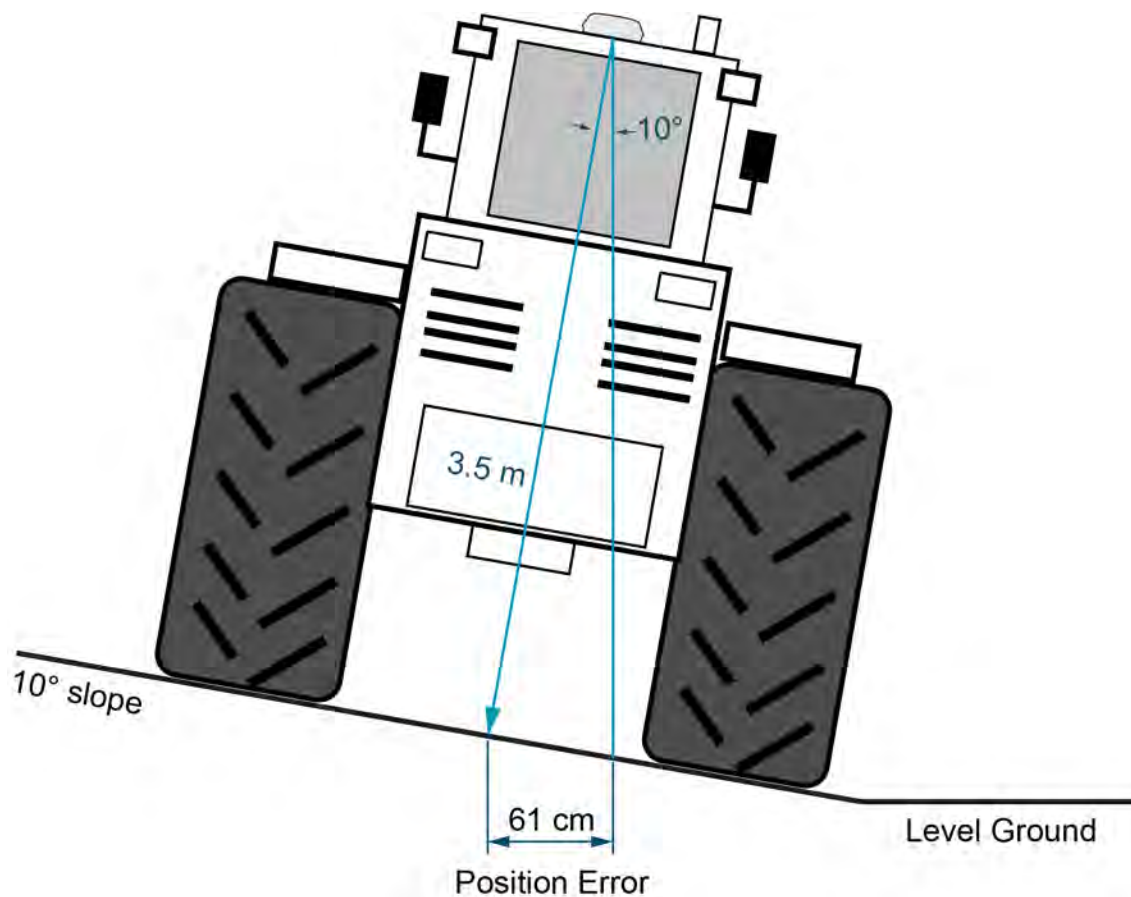

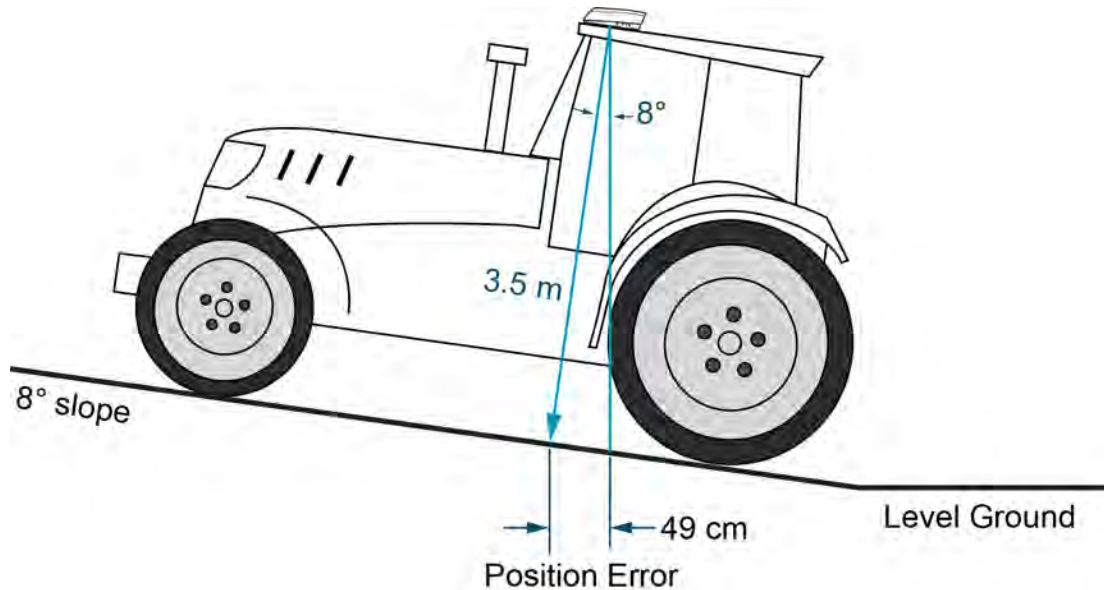
**Figure 13: Terrain Compensation – pitch**

If terrain compensation is enabled, the SMART Antenna determines the roll and pitch angles and corrects the position data before it is forwarded to the user equipment. In the example shown in *Figure 12: Terrain Compensation – roll* on the previous page, the roll angle is 10 degrees, so the position correction that needs to be applied is 61 cm. In the example shown in *Figure 13: Terrain Compensation – pitch* above, the pitch angle is 8 degrees, so the position error that needs to be applied is 49 cm.

The following logs provide terrain compensated positions:

- **BESTPOS** log
- **BESTXYZ** log
- **BESTUTM** log
- **GPGGA** log
- **GPGGALONG** log
- **GPGLL** log
- **GPRMC** log
- **PGN129025** NMEA log
- **PGN129027** NMEA log
- **PGN129029** NMEA log

Terrain Compensation is available on the following SMART Antennas:

- SMART7-W
- SMART7-I

### 3.10.1 Configuring Terrain Compensation

To fully install and set up Terrain Compensation:

1. Mount the SMART Antenna on the vehicle.
2. Measure and set the height of the SMART Antenna from the ground to the bottom of the antenna.

3. Level the tilt sensor.
4. Save the Terrain Compensation configuration data.

### Mount the SMART antenna

The SMART Antenna must be mounted as close to the center of the vehicle as possible with the top facing up with an unobstructed view of the sky all around, as illustrated in *Figure 14: SMART antenna installation* below.

**Figure 14: SMART antenna installation**

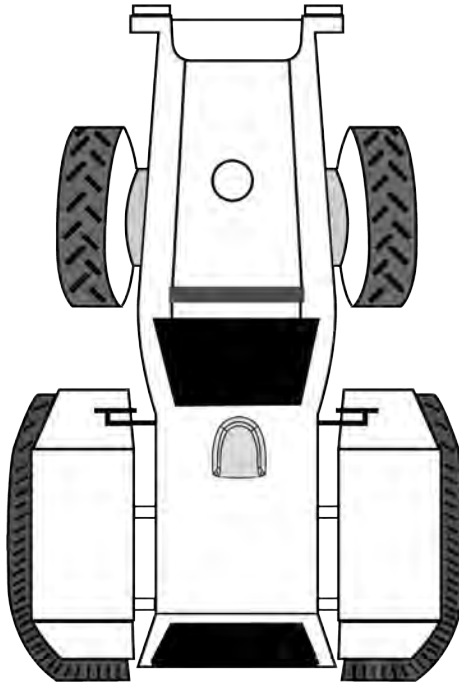

The SMART Antenna must be mounted with the connector facing the rear of the vehicle, as shown in *Figure 15: SMART antenna orientation* on the next page.

Figure 15: SMART antenna orientation

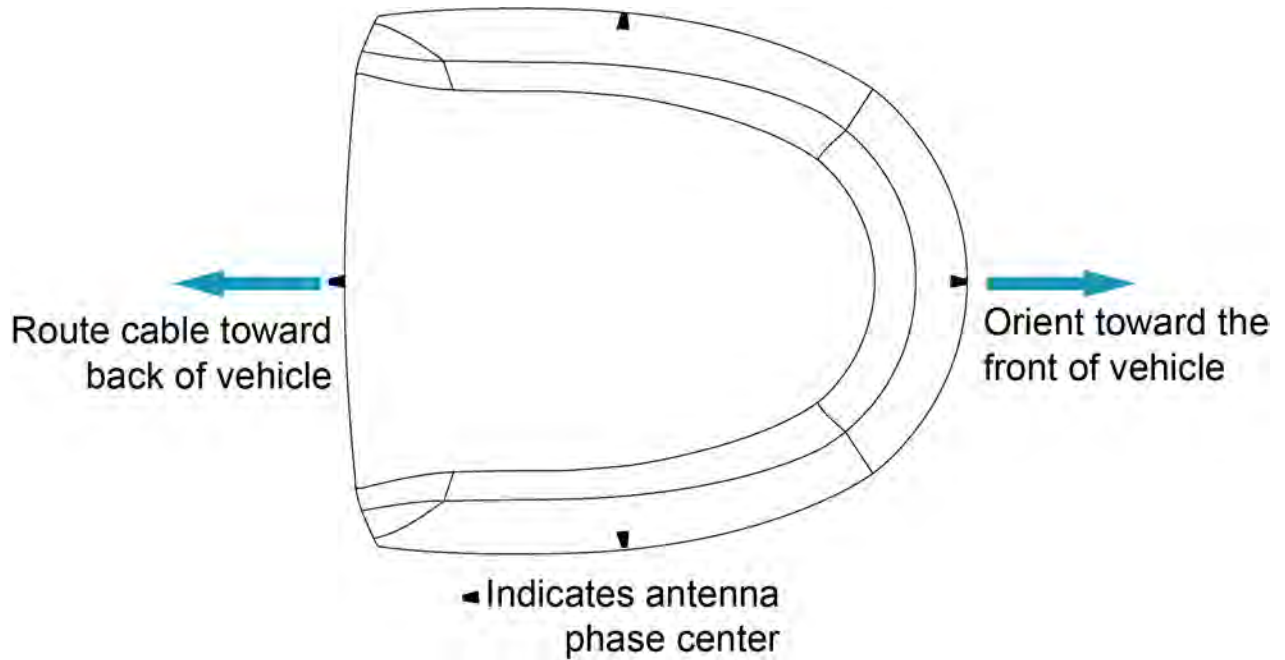

The SMART Antenna must be rigidly secured to the vehicle to minimize errors due to vibration and motion.

### Set the SMART antenna height and enable Terrain Compensation

The height measurement should be made while the vehicle has the correct tire pressure and is parked on a hard-packed and level surface. The measurement should be made, in metres, from the ground to the bottom of the SMART Antenna. The measurement accuracy should be within 2.5 to 5.0 cm.

Figure 16: Antenna height measurement

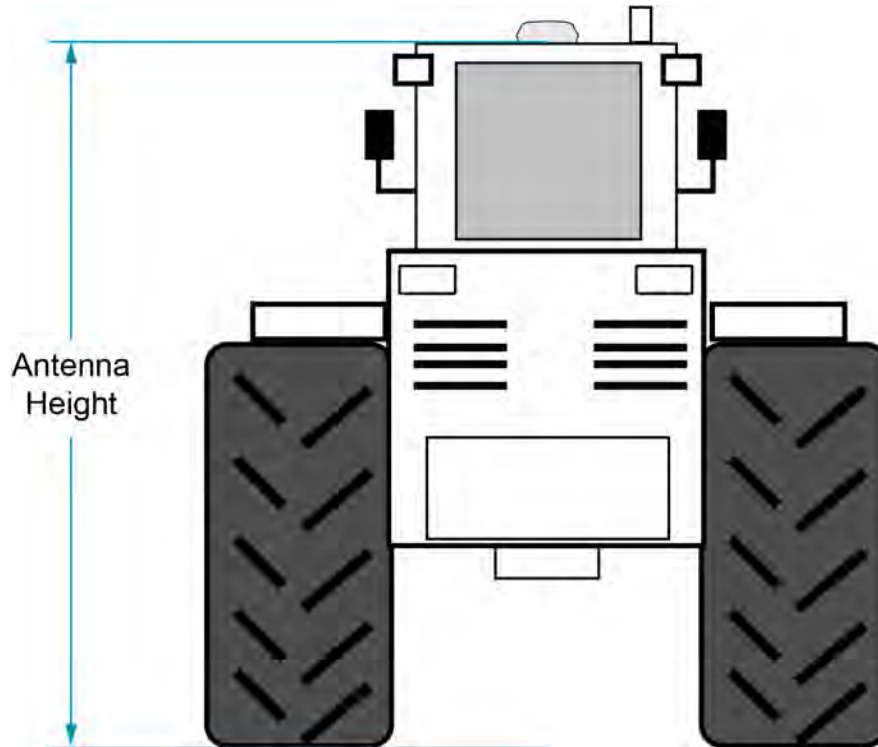

After the measurement has been made, use the **TILTFILTER** command to set the height of the SMART Antenna.

To set the height in metres:

1. Enter the following command to set the height.

```
TILTFILTER switch antennaheight
```

Where:

*switch* enables or disables Terrain Compensation  
*antennaheight* is the height measurement in metres

2. Enter the following command to ensure the height configuration is saved between power cycles.

```
TILTZERO SAVE
```

For example, to enable Terrain Compensation and set the SMART Antenna height to 3.5 metres, enter the following command:

```
TILTFILTER ENABLE 3.5  
TILTZERO SAVE
```

For more information, refer to the **TILTFILTER** command.



Changes in tire pressure over time can potentially cause errors in Terrain Compensation. This is because the height of vehicle can vary with tire pressure.



The **TILTFILTER** settings are saved using the **TILTZERO SAVE** command, not the **SAVECONFIG** command.

### Leveling the Terrain Compensation sensor

Two-stage zeroing should be used to level the Terrain Compensation sensor whenever possible.

#### Two-stage zeroing

Two-stage zeroing is the best way to level the Terrain Compensation sensor.



**Zeroing the Terrain Compensation sensor while moving will negatively impact performance. Always ensure the vehicle is stationary before zeroing the sensor.**



Two-Stage zeroing must be completed outside with good GNSS visibility. A level surface is not required.

To level the Terrain Compensation sensor, complete the following:

1. Park the vehicle where you can return to the same location but facing the opposite direction.
2. Ensure that you have good GNSS visibility.
3. Remain stationary for 15 seconds.
4. Begin the zeroing by issuing the following command:

```
TILTZERO NEW
```

5. Re-position the vehicle so that it is parked facing the opposite direction on the same spot, as close to 180 degrees as possible.
6. Remain stationary for 15 seconds.
7. Complete zeroing by issuing the following command:

```
TILTZERO ADD
```

8. Enter the following command to ensure the zeroing configuration is saved between power cycles.

```
TILTZERO SAVE
```

For more information, refer to the **TILTZERO** command.

#### Single-stage zeroing

Single-stage zeroing can be used as an alternative to two-stage zeroing.



**Zeroing the Terrain Compensation sensor while moving will negatively impact performance. Always ensure the vehicle is stationary before zeroing the sensor.**



A known level surface, such as a concrete floor of a shed or workshop, is required to perform the leveling using the single-stage zeroing procedure. GNSS visibility is not required.

To level the Terrain Compensation sensor, complete the following:

1. Park the vehicle on a known level surface.
2. Remain stationary for 15 seconds.
3. Complete zeroing by issuing the following command:

```
TILTZERO ZERO
```

4. Enter the following command to ensure the zeroing configuration is saved between power cycles.

```
TILTZERO SAVE
```

For more information, refer to the **TILTZERO** command.

### 3.10.2 Configuring Terrain Compensation using a NMEA command

Terrain Compensation can also be configured using the NMEA style command, \$PMDT.



Using the **\$PMDT** command is an alternative to using the **TILTFILTER** and **TILTZERO** commands. Either method will successfully configure the Terrain Compensation feature, however only the single-stage zeroing procedure is supported with the **\$PMDT** command. For best performance, two-stage zeroing is recommended.

#### Setting the SMART antenna height

The height measurement should be made while the vehicle has the correct tire pressure and is parked on a hard-packed and **level** surface. The measurement should be made from the ground to the bottom of the SMART Antenna connector. The measurement accuracy should be within 1 to 2 inches (2.5 to 5.0 cm).

After the measurement has been made (in feet and inches, or metres), use the **\$PMDT** command to set the height of the SMART Antenna.

To set the height in feet and inches, enter the following command:

```
$PMDT,u,,x,y*hh
```

Where:

x = the feet portion of the height measurement  
 y = the inches portion of the height measurement  
 hh = NMEA check sum

For example, entering the command **\$PMDT,u,,1,1\*78** will set the SMART Antenna height to 1 foot and 1 inch.

To set the height in metres, enter the following command:

```
$PMDT,a,,,,x.x*hh
```

Where:

x.x = the height measurement in metres  
 hh = NMEA check sum

For example, entering the command **\$PMDT,u,,,2\*66** will set the SMART Antenna height to 2 metres.

The SMART Antenna is shipped from the factory with the height set to 0.0 metres.

For more information, refer to the **\$PMDT** command.



Changes in tire pressure over time can potentially cause errors in Terrain Compensation. This is because the height of vehicle can vary with tire pressure.

### Leveling the Terrain Compensation sensor

The vehicle must be parked on flat ground when the level command is sent to the SMART Antenna.

To level the Terrain Compensation sensor, enter the following command:

```
$PMDT, 1*4D
```

For more information, refer to the **\$PMDT** command.

### Saving the Terrain Compensation configuration

After the height has been set or the Terrain Compensation sensor has leveled, the Terrain Compensation configuration must be saved. This is done so the height data and level setting are saved between power cycles. To save Terrain Compensation configuration, enter the following command:

```
$PMDT, x*59
```

For more information, refer to the **\$PMDT** command.

## 3.11 SMART antenna Emulated Radar

### 3.11.1 Emulated Radar (ER)

A typical radar sensor emits radio beams that bounce off the ground and computes ground speed based on the speed at which objects are passing in front of the sensor. The output of the sensor is a digital pulse, the frequency of which is proportional to the vehicle's ground speed. This is often used in agricultural applications such as planting and spraying. The SMART Antenna eliminates the need for separate ground-sensing radar equipment by converting the GPS-derived velocity to a proportional frequency output. The following emulated radar signal parameters can be configured by the customer:

- Frequency Step: Specifies how the frequency output relates to the vehicle speed.
- Signal Update Rate: Specifies how often the frequency output is updated to match the vehicle speed.
- Response Mode: Specifies how quickly changes in velocity are reflected in the frequency output. Setting a slower response mode reduces spikes (noise) in the velocity but increases latency. Setting a higher response mode reduces latency, but may result in noisier frequency output.

Refer to **RADARCONFIG** command for detailed information.

After it is configured using the **RADARCONFIG** command, Emulated Radar (ER) pulses are output through the SMART Antenna interface cable and the **RADARSTATUS** log.

## 3.12 Logging using NovAtel Application Suite or Manage Web

The NovAtel user interface tools, *NovAtel Application Suite* and *Manage Web*, provide a graphic user interface to configure the logs output from an OEM7 receiver.

For information about configuring logging using NovAtel Application Suite, refer to [docs.novatel.com/Tools/Content/Manage/ConfigurationLogging.htm](https://docs.novatel.com/Tools/Content/Manage/ConfigurationLogging.htm).

For information about configuring logging using Manage Web, refer to [docs.novatel.com/Tools/Content/WebUI\\_ConfigurationWindows/LoggingConfig.htm](https://docs.novatel.com/Tools/Content/WebUI_ConfigurationWindows/LoggingConfig.htm).



For information about using NovAtel Application Suite or Manage Web, refer to [docs.novatel.com/Tools](https://docs.novatel.com/Tools).

### 3.13 Precision Time Protocol

The Precision Time Protocol (PTP) feature is used to synchronize the clocks on the network to which the receiver is connected.



PTP is available on OEM729, OEM7600, OEM7700, OEM7720, PwrPak7, CPT7, CPT7700, SMART7-I and SMART7-SI receivers.

#### 3.13.1 Configuring PTP

The general use and configuration of a PTP network is beyond the scope of this document. The following is an overview of the steps to configure an OEM7 receiver to be part of a PTP network.

1. Configure the Ethernet settings on the receiver. Refer to *Ethernet configuration* on page 102 for information about configuring the receiver.

If using a dynamic IP address, ensure the network switch has DHCP enabled.

2. Use the **PTPMODE** command to enable PTP on the receiver.

```
PTPMODE ENABLE
```

3. Use the **PTPPROFILE** command to select the PTP profile used by the receiver.
4. Use the **PTPTIMESCALE** command to select the time scale used on the PTP network.

#### 3.13.2 Configuration notes

- Configure all of the PTP clocks to be synchronized on the network, so the transport mechanism, domain number, delay mechanism, best master clock algorithm, sync interval, and announce interval match.
- The receiver clock is never changed to be synchronized with another master clock. The difference between the receiver clock and the master clock is reported in the **PTPDELATIME** log.
- Configure the values of **priority1** and **priority2** for each PTP clock to ensure that the appropriate clock is selected as the best master under the appropriate conditions.
- For best synchronization performance, all PTP clocks must be connected only to PTP aware networking appliances (hubs, switches and routers). Specifically, all connections must be made via PTP boundary or transparent clocks.

At a minimum, all networking appliances must support the distribution of PTP multicast messages. Failing to use PTP boundary or transparent clocks for all interconnections will reduce the synchronization accuracy. However, the PTP protocol will continue to synchronize the clocks within the limits of the variability of PTP message transit times.

Consult the user documentation for the networking appliances to determine if the devices support PTP and how to configure them for PTP support.

- If PTP is enabled on multiple receivers and all receivers are reset, it is expected that all receivers will report **MASTER** for a few seconds before having all but one receiver switch to report **PASSIVE/SLAVE** in the **PTPDELATIME** log.

- If the master clock is not configured using the **PTPPROFILE** command (i.e. the PTPPROFILE command is left at the default value), the PTP algorithm will decide which device is the master regardless of which device is connected first.
- A peer-to-peer PTP network is designed to work with 2 clocks per subnet. Having more than two clocks will cause issues with PTP.
- If using any ITU profile, which is a forced PTP MASTER state, it is normal to see other receivers with the MASTER state. PTP will still only synchronize to the best clock.

### 3.13.3 Monitoring the PTP status

The status of PTP on the receivers is monitored using the **PTPDELTATIME** log. To check the status of PTP:

1. Collect the **PTPDELTATIME** log on each receiver.
2. Check the **PTP State** field of the PTPDELTATIME log for each receiver to ensure that only one device is reporting MASTER and all other devices are reporting PASSIVE or SLAVE (unless multiple masters have been specifically configured on the system).
3. Check the **Time Offsets Valid** field of the PTPDELTATIME log. All of the receivers should report a value of TRUE.
4. It is also beneficial to collect the **TIME** log and confirm the clock status of each receiver.

### 3.13.4 Troubleshooting

Networking issues are a primary cause of the PTP network not working as expected. While troubleshooting networking issues is beyond the scope of this manual, the following tips can be helpful starting points.

- Ensure that all receivers/devices are connected to the switch and are on the same subnet.
- Ensure IGMP snooping is turned off on the network switches (if that feature is available on the switches).
- Check the multicast address groups (IGMP querying) on the network switches.
- Network monitoring applications (such as the free program Wireshark) can be used to filter and view PTP specific messages. This can help to determine which devices are connected and sending PTP messages.

## Chapter 4 SMART7 with SPAN operation

---

NovAtel's SPAN GNSS+INS technology brings together two very different but complementary positioning and navigation systems namely Global Navigation Satellite System (GNSS) and an Inertial Navigation System (INS). By combining the best aspects of GNSS and INS into one system, SPAN technology is able to offer a solution that is more accurate and reliable than either GNSS or INS could provide alone. The combined GNSS+INS solution has the advantage of the absolute accuracy available from GNSS and the continuity of INS through traditionally difficult GNSS conditions.

A SPAN system consists of the following components:

- NovAtel GNSS receiver  
The NovAtel OEM7 GNSS receiver uses a combination of GPS, GLONASS, Galileo, BeiDou, NavIC and QZSS signals to calculate an accurate GNSS position. The OEM7 receiver also supports the timing requirements of the IMU and runs the real-time INS filter.
- IMU  
The Inertial Measurement Unit (IMU) consists of three accelerometers and three gyroscopes (gyros) so that accelerations along specific axes and angular rotations can be measured.
- GNSS antenna

In the SMART7-S and SMART7-SI, all three of these components are included in the SMART7 enclosure. After the SMART7 is installed, the appropriate power supply is attached, and a few simple configuration commands are entered, the SPAN system will be ready to navigate.

### 4.1 Fundamentals of GNSS+INS

GNSS positioning observes range measurements from orbiting GNSS satellites. From these observations, the receiver can compute position and velocity with high accuracy. NovAtel GNSS positioning systems are highly accurate positioning tools. However, GNSS in general has some restrictions which limit its usefulness in some situations. GNSS positioning requires line of sight view to at least four satellites simultaneously. If these criteria are met, differential GNSS positioning can be accurate to within a few centimetres. If however, some or all of the satellite signals are blocked, the accuracy of the position reported by GNSS degrades substantially, or may not be available at all.

In general, an INS uses forces and rotations measured by an IMU to calculate position, velocity and attitude. This capability is embedded in the firmware of OEM7 receivers. Forces are measured by accelerometers in three perpendicular axes within the IMU and the gyros measure angular rotation rates around those axes. Over short periods of time, inertial navigation gives very accurate acceleration, velocity and attitude output. The INS must have prior knowledge of its initial position, initial velocity, initial attitude, Earth rotation rate and gravity field. Since the IMU measures changes in orientation and acceleration, the INS determines changes in position and attitude, but initial values for these parameters must be provided from an external source. Once these parameters are known, an INS is capable of providing an autonomous solution with no external inputs. However, because of errors in the IMU measurements that accumulate over time, an inertial-only solution degrades with time unless external updates such as position, velocity or attitude are supplied.

The SPAN system's combined GNSS+INS solution integrates the raw inertial measurements with all available GNSS information to provide the optimum solution possible in any situation. By using the high accuracy GNSS solution, the IMU errors can be modeled and mitigated. Conversely, the continuity and relative accuracy of the INS solution enables faster GNSS signal reacquisition and RTK solution convergence.

The advantages of using SPAN technology are its ability to:

- Provide a full attitude solution (roll, pitch and azimuth)
- Provide continuous solution output (in situations when a GNSS-only solution is impossible)
- Provide faster signal reacquisition and RTK solution resolution (over stand-alone GNSS because of the tightly integrated GNSS and INS filters)
- Output high-rate (up to the IMU data rate depending on your logging selections) position, velocity and attitude solutions for high-dynamic applications, see also *Logging restriction important notice* on page 85
- Use raw phase observation data (to constrain INS solution drift even when too few satellites are available for a full GNSS solution)



For more information about GNSS and INS, refer to *An Introduction to GNSS* available on our website at [novatel.com/an-introduction-to-gnss](http://novatel.com/an-introduction-to-gnss)

## 4.2 Definition of reference frames within SPAN

The reference frames that are most frequently used throughout the SPAN documentation are the following:

- *Local-level frame (ENU)* below
- *IMU body frame* on the next page
- *Vehicle frame* on the next page
- *User output frame* on page 65

### 4.2.1 Local-level frame (ENU)

The definition of the local level coordinate frame is as follows:

- E – pointing east
- N – pointing north
- U – pointing up

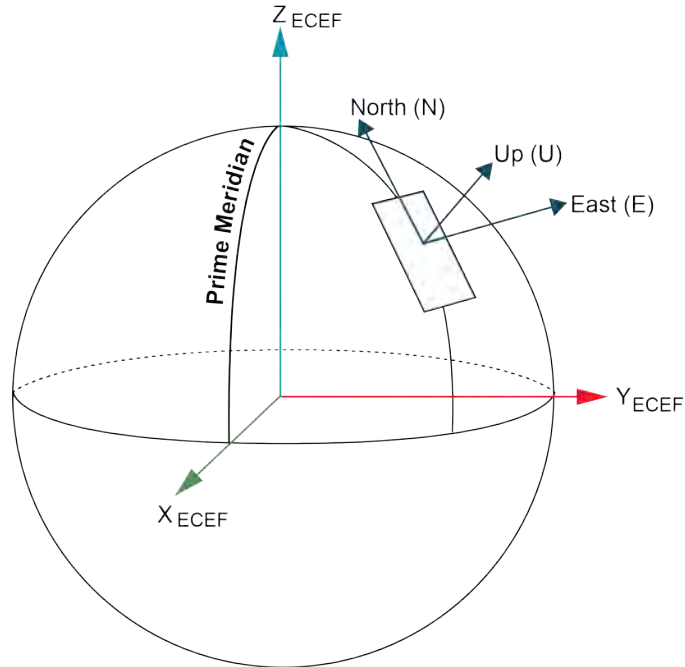
**Figure 17: Local-level frame (ENU)**

### 4.2.2 IMU body frame

The definition of the IMU Body frame is given by the physical axes of the IMU and represents how the sensors are mounted inside the IMU. Refer to *SMART7 mechanical specifications* on page 156 for illustrations of the IMU Body frame axes.

The origin of this frame is not the enclosure center, but the center of navigation (sensor center).

### 4.2.3 Vehicle frame

The definition of the vehicle frame is as follows:

- z-axis – points up through the roof of the vehicle perpendicular to the ground
- y-axis – points out the front of the vehicle in the direction of travel
- x-axis – completes the right-handed system (out the right-hand side of the vehicle when facing forward)

Figure 18: Vehicle frame

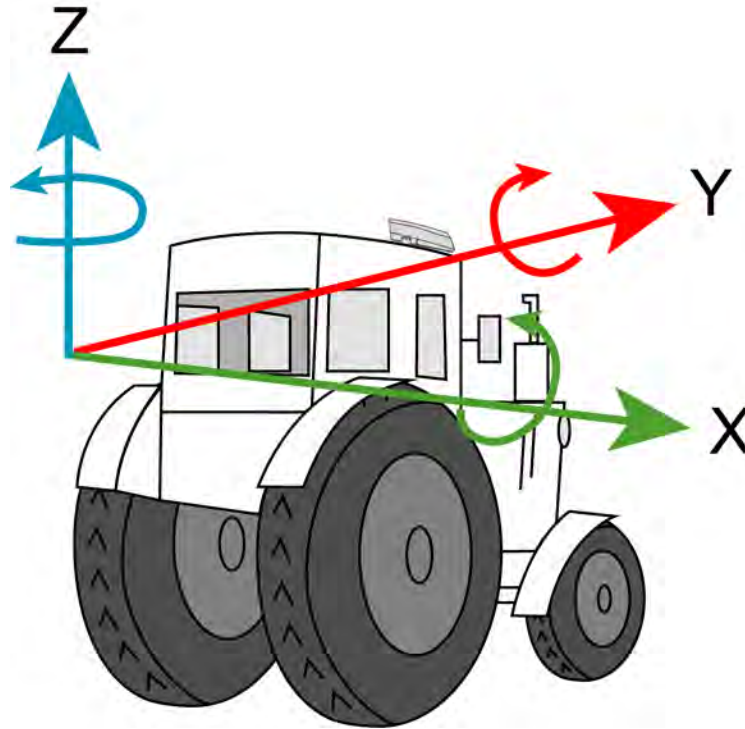

#### 4.2.4 User output frame

The user output frame is an arbitrary frame, which can be optionally defined to transfer inertial output to a more useful position or reference frame.

By default, SPAN position and velocity output is given at the center of navigation of the IMU. To output position and velocity at a different location, specify a user offset translation using the **SETINSTRANSLATION** command.

By default, SPAN attitude output is the rotation from the Local-Level frame to the Vehicle frame. If attitude output is desired relative to another frame, specify a user offset rotation using the **SETINSROTATION** command.

### 4.3 SPAN translations and rotations – SMART7

A SPAN system combines GNSS and INS into a single system. In a GNSS system, the position is reported relative to the phase center of the GNSS antenna. In an INS system, the position, velocity and attitude data is reported relative to the center of navigation of the IMU. For a SPAN system to provide a combined GNSS+INS position, velocity and attitude, it must know where the GNSS antenna is positioned relative to the IMU.

The orientation of the IMU relative to the forward direction of the vehicle is also needed to convert the velocity and attitude changes sensed by the IMU into the actual motion of the vehicle.

If the SPAN system incorporates other devices, the SPAN system also needs to know the location and orientation of these additional devices relative to the IMU.

#### 4.3.1 Translational offsets

The three dimensional distances between the IMU and other SPAN components are called translational offsets.

The translational offsets are measured in three directions, X axis, Y axis and Z axis, typically relative to the IMU Body frame. Translational offsets can also be entered relative to the Vehicle frame.



The X, Y and Z axes of the IMU Body frame are indicated on the SMART7 mechanical drawings. See *SMART7 mechanical specifications* on page 156.

The translational offsets from the IMU to the GNSS antenna are required for all SPAN systems. Since the IMU and GNSS antenna are inside the SMART7 enclosure, the IMU to antenna offset is configured at the factory. No additional translational offset configuration is needed on the SMART7, unless there are additional SPAN system components that require an offset.



**Do not use the SETINSTRANSALATION ANT1 command to change the IMU to primary antenna offset. Changing this value from the factory default will impair SPAN system performance.**

Some SPAN systems may have other sensors or devices integrated into the system for which the SPAN needs translational offsets. For example, a second receiver and GNSS antenna in a SPAN ALIGN system. The offsets to these additional sensors and devices are also entered using the **SETINSTRANSALATION** command.

*Figure 19: ALIGN translation offset* below shows an example of the translational offsets between a SMART7-S and a SMART7 in an ALIGN configuration. In this example, the SMART7-S is mounted at rear left corner of the tractor roof and the IMU Body Frame of the SMART7-S (indicated by the small arrows) has the X axis pointing in the direction of the vehicle motion and the z axis pointing down.

**Figure 19: ALIGN translation offset**

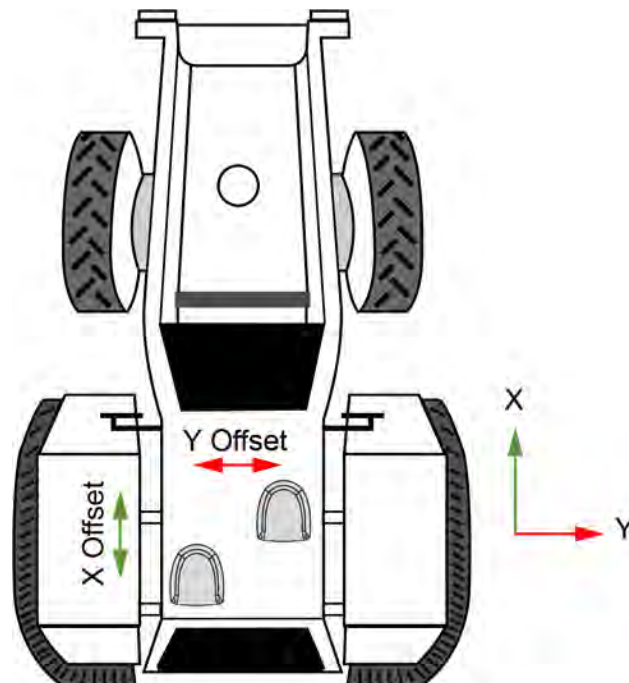

If the distances measured in this example were X Offset = 1.5 m, Y Offset = 1 m and Z Offset = 0 m, the following values would be entered, based on the IMU Body Frame:

- $x = 1.5$
- $y = 1.0$
- $z = 0$

The translational offsets are entered using the **SETINSTRANSLATION** command. For this example, the command to enter these offsets is:

```
SETINSTRANSLATION ANT2 1.5 1.0 0
```



The measurements for the translational offsets should be done as accurately as possible, preferably to within millimetres especially for RTK operation. Any error in the offsets will translate into an error in the INS position.

By default, the translational offsets are entered in the IMU Body frame. However, in some systems the IMU Body frame may not be known precisely. For these cases, the **SETINSTRANSLATION** command has an option that allows the offsets to be entered relative to the Vehicle frame. In these cases, the rotation from the IMU Body frame to the Vehicle frame (RBV) is used to rotate offsets into the default IMU Body frame as required. To achieve the best results, this means that the RBV rotation must be known very precisely. Typically this is achieved through the SPAN RBV Calibration procedure. See *Body to vehicle frame rotation calibration routine* on page 86 or *Multi-line body to vehicle frame rotation calibration routine* on page 87 for information about this calibration procedure.

### 4.3.2 Rotational offsets

The differences in orientation between the SMART7 and other SPAN components are called rotational offsets. Rotational offsets are given as the rotation from the IMU Body frame to the frame of interest.



The order of rotations is Z-X-Y and all rotations are right handed.

Generally, frames of reference are defined as Z up, with Y forward, and X completing the right-handed system. An example is the Vehicle frame, where Z is always considered to be upwards, Y forward through the direction of travel, and X to the right.

If the SMART7 is installed with the front of the SMART7 facing the direction of forward motion for the vehicle (as shown in *Figure 6: SMART7 orientation* on page 28), an IMU Body frame to Vehicle frame rotation is not required. The necessary rotations are configured at the factory.



An IMU Body frame to Vehicle frame calibration routine should be run to on all SMART7 installations, whether an IMU Body frame to Vehicle frame rotation is required or not. See *Body to vehicle frame rotation calibration routine* on page 86 or *Multi-line body to vehicle frame rotation calibration routine* on page 87 for more information. This calibration routine should be done each time the SMART7 is remounted.

### Non-standard installation

The SMART7 is intended to be installed with the front of the SMART7 facing the direction of vehicle travel. If the installation location does not allow this orientation, the **SETINSROTATION RBV** command must be used to align the SMART7 IMU Body frame with the Vehicle frame.

The IMU Body frame of the SMART7-S is shown in *Figure 20: SMART7-S and SMART7-SI IMU body frame* below.

**Figure 20: SMART7-S and SMART7-SI IMU body frame**

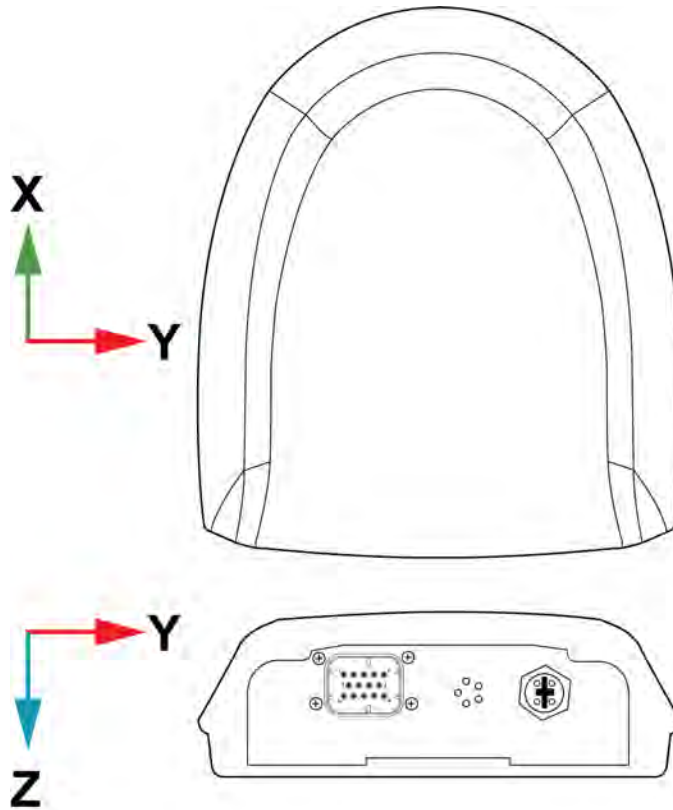

At the factory, the following command is entered to configure rotations required to align the IMU Body frame so that the Z axis points up and the Y axis points out the front of the SMART7-S. See *Figure 21: SMART7-S and SMART7-SI IMU body frame with factory configured rotation* on the next page.

```
SETINSROTATION RBV 180 0 90
```

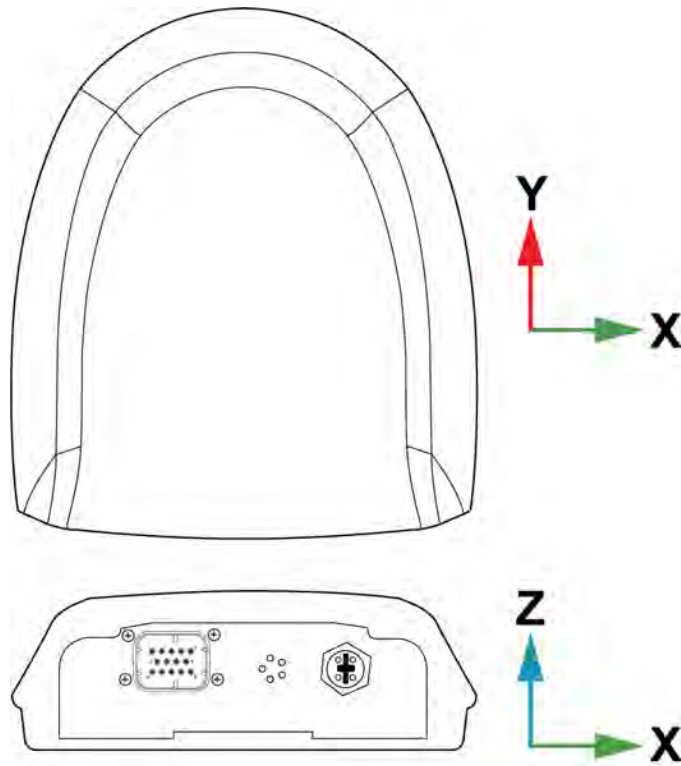
**Figure 21: SMART7-S and SMART7-SI IMU body frame with factory configured rotation**

If SMART7-S is not installed with the front of the SMART7-S facing the direction of vehicle travel, a different set of rotations must be entered using the **SETINSROTATION RBV** command.

### Rotational offsets – example

Consider a SMART7-S installed as shown in the following diagram. In this installation, the factory configured rotation does not align the IMU Body frame with the Vehicle frame. Therefore, a new IMU Body to Vehicle frame rotation must be entered using the **SETINSROTATION RBV** command.

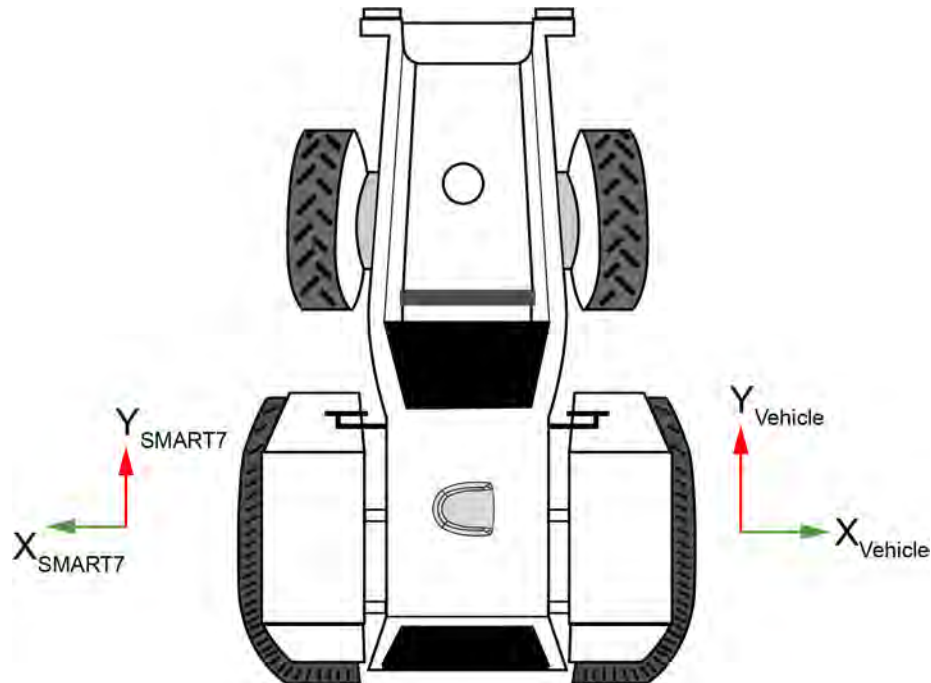
**Figure 22: SMART7-S installed with orientation not aligned with vehicle frame**

In this example, the Euler Angles to rotate from the IMU Body frame (*Figure 20: SMART7-S and SMART7-SI IMU body frame* on page 68) to the Vehicle frame (RBV) are:

- X: 0
- Y: 180
- Z: 0

To reach this answer, keep in mind the following rules:

- You must rotate from the IMU Body frame to the Vehicle frame.
- You must rotate in the order Z, X, Y. Specifically Z, X', Y''
- Positive rotation is defined according to the right hand rule.

The following diagram shows the IMU Body frame of the SMART7-S and the Vehicle frame for the example installation shown in *Figure 22: SMART7-S installed with orientation not aligned with vehicle frame* above.

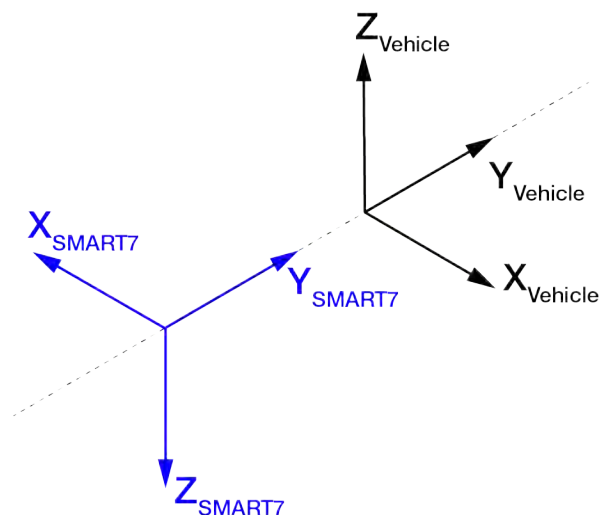

**Z Rotation:**

Since the Y axis of the IMU Body frame is collinear with vehicle Y axis, a Z rotation is not required.

**X Rotation:**

Since the Y axis of the IMU Body frame is collinear with the vehicle Y axis, an X rotation is also not required

**Y Rotation:**

Observe that if a 180 degree rotation is performed about the IMU Body frame Y axis, the rotated IMU Z axis is now collinear with the Vehicle Z axis, and the rotated IMU X axis is also collinear with the Vehicle X axis.

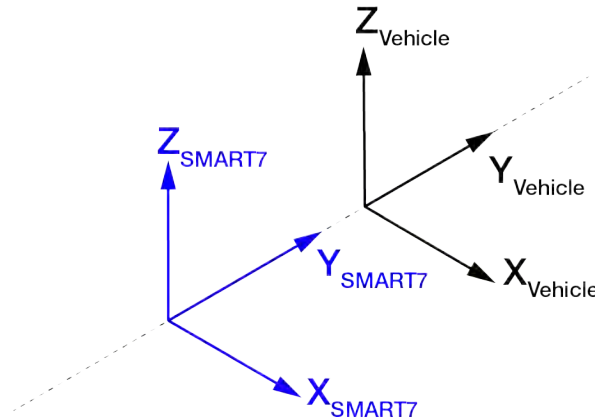

This solution is not unique. Due to the properties of Euler Angles, there are usually multiple sets of equivalent rotations.

The rotational offsets are entered using the **SETINSROTATION** command. For this example, the command to enter the rotations for the previous example is:

```
SETINSROTATION RBV 0 180 0
```

### 4.3.3 Importance of RBV calibration

For the SPAN system to provide the best performance, the rotation offset of the IMU body to the Vehicle frame (RBV) should be known as accurately as possible. Since constraints happen at the vehicle level, any error in the offset will translate into worse performance.

After the SPAN system has been installed and the appropriate translations and rotations have been applied (see *SPAN translations and rotations – SMART7* on page 65), the IMU Body frame is aligned with the Vehicle frame. However, aspects of the mounting platform and vehicle design, such as roof camber or tilt, and slight misalignments in installation can cause the IMU Body frame to be slightly out of alignment with the Vehicle frame. The misalignment of the IMU Body frame from the Vehicle frame will add a bias to the SPAN solution.

The following diagrams show examples of a SMART7-S installed in a vehicle with misalignment issues.

**Figure 23: Rear view of SMART7-S on a vehicle – roof camber**

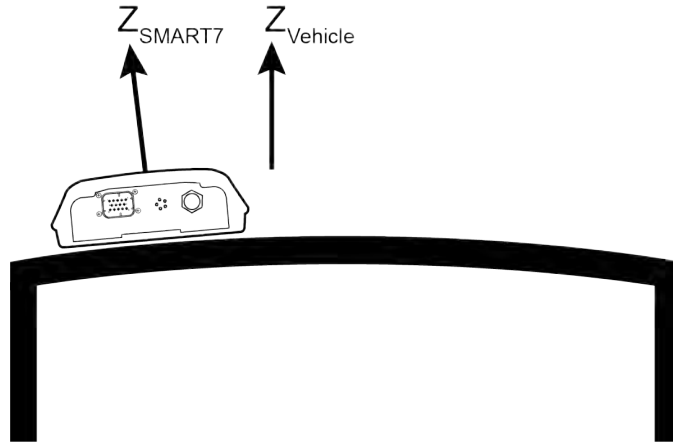

**Figure 24: Side view of SMART7-S on a vehicle – roof tilt**

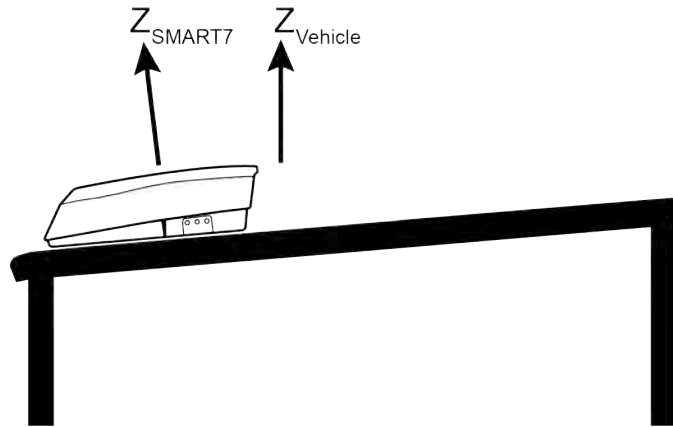

**Figure 25: Top view of SMART7-S on a vehicle – SMART7-S misalignment**

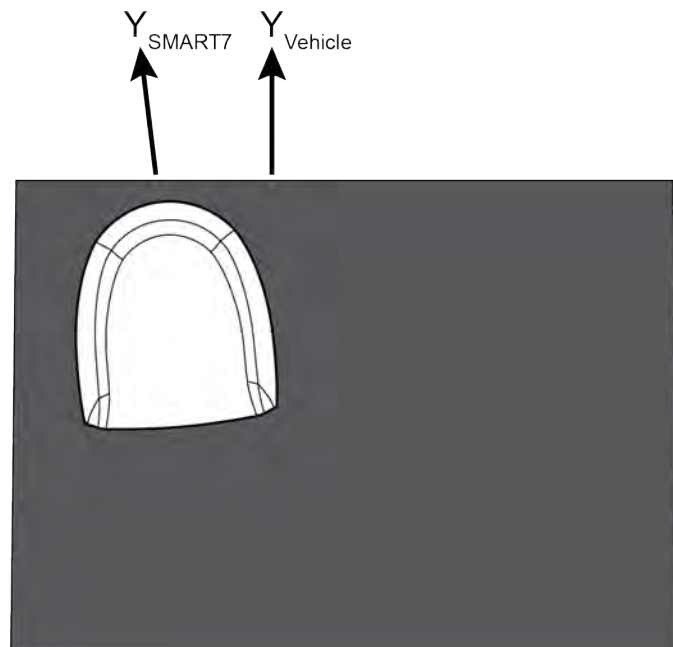



The misalignments shown in the previous figures have been exaggerated for illustration purposes.

In a typical SPAN system installation, the slight misalignments shown in the examples above are hard to detect and difficult to measure. For this reason, it is recommended that a Body to Vehicle Frame rotation calibration routine be used so the SPAN system can determine and compensate for these angles. Refer to *Body to vehicle frame rotation calibration routine* on page 86 or *Multi-line body to vehicle frame rotation calibration routine* on page 87 for more information.

These parameters are estimated in the background when the system is fully converged, however it is always better to have this measured as precisely as possible before mission critical data is collected.



Since slight variations in alignment can be introduced when the SMART7-S is remounted, a Body to Vehicle Frame calibration should be performed each time the device is remounted.



**An accurate RBV is especially important if the position is being transferred to a implement.**

## 4.4 Vibration considerations

When designing a system that integrates SPAN, achieving excellent navigation performance requires considering the vibration environment in which the IMU will operate. IMU sensors measure motion, which may consist of real platform motion but also vibration. The INS mechanizes these measurements into a full position, velocity, and attitude solution. Vibration can significantly degrade INS performance by introducing noise or errors into the IMU sensor measurements. It can be especially impactful when unfavorable INS performance conditions are present, like poor GNSS reception, low dynamics and non-optimal configurations. Managing vibration is very important to achieve optimal SPAN system performance.

### 4.4.1 Sources of error

Vibration affects an INS in several different ways that should be considered.

Noise and errors in the raw IMU measurements can arise from:

- Aliasing – signals at frequencies higher than the sampling rate incorrectly appear at low frequencies or as a bias.
- Clipping – the measurement range of the sensor is exceeded, inducing error in measurements and a bias in the smoothed measurements.
- Vibration Rectification Error (VRE) – changes in vibration induce a bias in the measurements that cannot be filtered out.
- Amplification of standard IMU errors – as measurements approach the range limits of the sensor, even when oscillating around a mean near zero.

INS solution quality experienced at the output from a SPAN system is impacted by:

- IMU lever arm rigidity and accuracy – vibration can cause more flexing and make rigid body assumptions less applicable.
- USER lever arm configuration – oscillation of the INS solution attitude due to vibration amplifies noise and apparent error when the solution is translated to the USER offset.

- SPAN logging configuration (i.e. solution output sampling rate) – insufficient logging rates can cause aliasing in the output solution if oscillation frequency in the INS solution due to vibration exceeds half the output logging rate.

#### 4.4.2 Mitigation methods

Vibration is best mitigated in the mechanical domain prior to IMU exposure. Key methods to mitigate in the mechanical domain include:

- Selecting the IMU mounting location to achieve subsystem separation, structural rigidity considerations, and optimal locations for system dynamics and lever arms.
- Appropriate IMU mounting methods that prioritize rigidity and dimensional stability.
- Carefully designed custom IMU mounts that incorporate vibration isolation features.
- Characterization and minimization of unwanted resonance in the system in the context of system vibration sources.

When the IMU will be exposed to vibration, robust IMU specification design is important to ensure the INS performs adequately in the overall system. For example, the IMU measurement range to avoid signal clipping when exposed to the combination of vibration, maximum system dynamics and gravity. The needs of individual applications will vary and may benefit from an iterative system design approach to manage tradeoffs.

The interface design between the INS and overall system must support the logging configuration and rates needed to minimize solution signal distortion and support any monitoring, post-processing or control loop requirements. Using an anti-aliasing filter at the solution output may be necessary. Contact *Customer Support* on page 17 for additional information.

#### 4.4.3 Additional notes

The unique characteristics of each SPAN system integration requires a tailored vibration management approach within the context of the application. A general solution is not appropriate given the range of vibration environments and system requirements.

An important aspect of the vibration management approach is that changing vibration conditions are most impactful to INS performance.

With careful consideration of vibration early in the system design cycle, optimal SPAN performance can be achieved.



For in-depth information about vibration, please review NovAtel Application Note [APN-112: Inertial Navigation System and Vibration](#).

## 4.5 Software configuration

On a SPAN system, both the GNSS receiver and the IMU must be configured.

### 4.5.1 GNSS configuration

The GNSS configuration can be set up for different accuracy levels such as single point, SBAS, DGNSS, PPP and RTK. Refer to *Transmitting and receiving corrections* on page 39, *TerraStar Correction Services* on page 46 or *Enabling SBAS positioning* on page 46.

With no additional configuration, the system operates in single point mode.

## 4.5.2 SPAN configuration for SMART7-S

- *Minimum recommended configuration below*
- *Configure SPAN manually below*
- *SPAN configuration with NovAtel Application Suite on the next page*
- *SPAN configuration with Manage Web on the next page*

### Minimum recommended configuration

When configuring your SMART7 SPAN system for first time use, the following is the minimum amount of information required to ensure proper operation of a SPAN system.

Required information	Required command
IMU to vehicle frame rotation	SETINSROTATION RBV

While this is the minimum amount of information required, additional information is typically needed for SPAN systems. The following commands are commonly used to configure SPAN systems.

Common user settings	Appropriate command	Notes
IMU to output position offset	SETINSTRANSFORMATION USER	Default output position is at the IMU center
IMU to output frame rotation	SETINSROTATION USER	Default output frame is the vehicle frame
IMU to secondary antenna lever arm	SETINSTRANSFORMATION ANT2	Only required if the SMART7 is part of an ALIGN system.
Minimum alignment velocity	SETALIGNMENTVEL	

### Configure SPAN manually

To enable INS as part of the SPAN system using software commands:



The SMART7 must be mounted with a clear view of the sky and tracking satellites for operation.

1. Issue the **SETINSROTATION** command, using the **RBV** parameter, to enter the Euler Angle rotation from the IMU Body frame of the SMART7 to the Vehicle frame. See the **SETINSROTATION** command in the [OEM7 Commands and Logs Reference Manual](#) for more information.

Accurate knowledge of the rotational offset between the IMU Body frame and the Vehicle frame (the RBV rotation) is critical to correctly computing an attitude solution, and is required before a Kinematic alignment is possible.

The SETINSROTATION parameters are (where the standard deviation fields are optional):

```
RBV x_rotation y_rotation z_rotation [x_stddev] [y_stddev] [z_stddev]
```



The order of rotations is Z-X-Y. All rotations are right handed.

For an example of how to solve for the IMU Body to Vehicle frame rotation refer to *Rotational offsets* on page 67.

If the rotation between the IMU Body frame and the Vehicle frame is not precisely known, enter an approximate rotation (to the nearest 45 degrees). The precise offset can be estimated by carrying out the *Body to vehicle frame rotation calibration routine* on page 86.

### SPAN configuration with NovAtel Application Suite

The SPAN parameters can be configured using NovAtel Application Suite. For information about installing and using NovAtel Application Suite, refer to the online documentation ([docs.novatel.com/Tools/Content/ToolsSuite/Overview.htm](https://docs.novatel.com/Tools/Content/ToolsSuite/Overview.htm)).

### SPAN configuration with Manage Web

The SPAN parameters can be configured using the Manage Web. For information about using Manage Web, refer to the online documentation ([docs.novatel.com/Tools/Content/Manage\\_Web/Overview.htm](https://docs.novatel.com/Tools/Content/Manage_Web/Overview.htm)).

## 4.6 Real-time operation

SPAN operates through the OEM7 command and log interface. Refer to the [OEM7 Commands and Logs Reference Manual](#) log and command details.

Real-time operation notes:

- By default, raw IMU data will begin to output as soon as the IMU is connected. However, an initial position is required to begin the INS alignment process. This position is typically set by GNSS. The GNSS position will not be used until the FINESTEERING time status is reached. This requires a GNSS antenna connected with a clear view of the sky. See *System start-up and alignment techniques* on the next page for more details.
- The inertial solution is computed separately from the GNSS solution. The GNSS solution is available from the SPAN system through the GNSS-specific logs, even without SPAN running. The integrated GNSS+INS solution is available through special INS logs documented in SPAN Logs in the [OEM7 Commands and Logs Reference Manual](#).
- The IMU raw data is available at the maximum rate of output of the IMU. Because of this high data rate, a shorter header format was created. These shorter header logs are defined with an S (RAWIMUSXB rather than RAWIMUXB). We recommend you use these logs instead of the standard header logs to save throughput on the COM port.

Status of the inertial solution can be monitored using the inertial status field in the INS logs.

**Table 10: Inertial solution status**

Binary	ASCII	Description
0	INS_INACTIVE	IMU logs are present, but the alignment routine has not started; INS is inactive.
1	INS_ALIGNING	INS is in alignment mode.

Binary	ASCII	Description
2	INS_HIGH_VARIANCE	The INS solution uncertainty contains outliers and the solution may be outside specifications. <sup>1</sup> The solution is still valid but you should monitor the solution uncertainty in the <b>INSSTDEV</b> log. It may be encountered during times when GNSS is absent or poor.
3	INS_SOLUTION_GOOD	The INS filter is in navigation mode and the INS solution is good.
6	INS_SOLUTION_FREE	The INS Filter is in navigation mode and the GNSS solution is suspected to be in error. The inertial filter will report this status when there are no available updates (GNSS or other) being accepted and used.
7	INS_ALIGNMENT_COMPLETE	The INS filter is in navigation mode, but not enough vehicle dynamics have been experienced for the system to be within specifications.
8	DETERMINING_ORIENTATION	INS is determining the IMU axis aligned with gravity.
9	WAITING_INITIALPOS	The INS filter has determined the IMU orientation and is awaiting an initial position estimate to begin the alignment process.
10	WAITING_AZIMUTH	The INS filter has orientation, initial biases, initial position and valid roll/pitch estimated. Will not proceed until initial azimuth is entered.
11	INITIALIZING_BIASES	The INS filter is estimating initial biases during the first 10 seconds of stationary data.
12	MOTION_DETECT	The INS filter has not completely aligned, but has detected motion.
14	WAITING_ALIGNMENTORIENTATION	The INS filter is waiting to start alignment until the current Vehicle Frame roll and pitch estimates are within the configured threshold of the expected orientation (set by the <b>SETALIGNMENTORIENTATION</b> command).  <b>Note:</b> This requires an accurate RBV rotation to be configured, see the <b>SETINSROTATION</b> command.

#### 4.6.1 System start-up and alignment techniques

The SPAN system requires an initial position, velocity and attitude estimate to start the navigation filter. This is called system alignment. On start-up, the system has no position, velocity or attitude information. When the system is first powered up, the following sequence of events happens:

1. The first satellites are tracked and coarse time is solved.
2. Enough satellites are tracked to compute a position.
3. Receiver “fine time” is solved, meaning the time on board the receiver is accurate enough to begin timing IMU measurements.
4. The INS Status field changes from **INS\_INACTIVE** through **DETERMINING\_ORIENTATION** and **WAITING\_INITIALPOS**.

---

1. The solution uncertainty threshold levels can be adjusted using the **INSTHRESHOLDS** command.

5. Once a GNSS position is available, an initial IMU bias estimate is conducted. During this period, the INS Status field reports INITIALIZING\_BIASES.
6. After the bias estimate is complete, the coarse alignment routine starts. Bias estimates will be refined and a static coarse alignment completed, if IMU quality allows. During this period the INS Status field reports INS\_ALIGNING.
7. If static coarse alignment is not possible or is locked out by command, the system will require an external azimuth input, either from vehicle motion, dual antenna input or command input. While in this state the INS Status field reports WAITING\_AZIMUTH.  
  
If vehicle movement is detected, any ongoing static coarse alignment will be reset, and the INS Status field will report MOTION\_DETECT.
8. After an alignment is completed, the INS Status field changes to INS\_ALIGNMENT\_COMPLETE. The system transitions to *Navigation mode* on page 83.
9. The solution is refined using updates from GNSS. Once the system starts estimating the IMU errors after some vehicle movement, the INS Status field will change to INS\_SOLUTION\_GOOD indicating INS solution has achieved a basic level of convergence. Note that it is advised to continue converging dynamics until the convergence flag is set to 1 in the Extended Solution Status word. This indicates that the INS filter has successfully converged to within performance specifications.

## SPAN alignment methods

The following sections describe the different alignment routines available. By default, the first available method to align is used. Options for configuring a specific alignment methods are outlined below.

### Static coarse alignment

The static coarse alignment is the default alignment routine for SPAN. The alignment starts automatically when a GNSS solution is available, the receiver has computed fine time, the IMU is connected and configured, and initial bias estimates have been completed. During the static coarse alignment, accelerometer and gyro measurements are averaged over a period of time to measure Earth rotation and gravity. From these averaged measurements, initial estimates of roll, pitch and heading are computed. Because the static coarse alignment uses averaged sensor output, the vehicle must remain stationary for the duration of the alignment, which is approximately 45 seconds. The attitude estimates solved by the alignment are larger than the system specified attitude accuracy and vary upon the characteristics of the sensor and the geographic latitude of the system. Attitude accuracy converges with motion after the coarse alignment is complete (see *Navigation mode* on page 83).



All **Grade 1** IMUs, as well as the HG4930 400Hz variant, and products that use these IMUs, cannot perform static coarse alignments, as these IMUs cannot accurately measure Earth rotation (see IMU Grade on the OEM7 Documentation Portal ([docs.novatel.com/OEM7](https://docs.novatel.com/OEM7))). For these IMUs, the default alignment routine is kinematic alignment. Refer to *Kinematic alignment* on the next page. If a stationary alignment is required, refer to options for *Dual antenna alignment* on the next page, *NVM seeded alignment* on the next page, or *Manual alignment* on the next page.



**Static Coarse alignments may be degraded due to environment, vibration or IMU age effects. Any error in initial alignment can cause performance issues.**

## Kinematic alignment

An alternate form of aligning the SPAN system is a kinematic alignment. A kinematic alignment can be used for any SPAN system and is the best alignment alternative for lower performance sensors (**Grade 1** IMUs, as well as the HG4930 400Hz variant, and products that use these IMUs). The kinematic or moving alignment is performed by estimating the heading from the GNSS velocity vector and injecting it into the SPAN filter as the initial system heading.

For the kinematic alignment routine to work optimally, the course-over-ground azimuth must not include any bias from the defined Vehicle Frame. (For example, a plane being blown in the wind has a large 'crab angle' and the course-over-ground trajectory will not match the direction the IMU is pointing.)

The rotation from the IMU Body frame to the Vehicle frame (RBV) must be set to enable kinematic alignment. In order to simplify this configuration it is strongly suggested that you mount the IMU in parallel to the vehicle frame.

The SMART7-S simplifies the alignment configuration by setting the default translation and rotation values. To make use of these defaults ensure the SMART7-S is mounted in the right orientation. The SMART7-S should be oriented as shown in *Figure 6: SMART7 orientation* on page 28.

The kinematic alignment begins when the receiver has a good GNSS position, fine time is solved, the Body to Vehicle frame rotation is known and a GNSS velocity of at least 0.5 m/s. For optimal performance, it is recommended to keep the vehicle fairly level during kinematic alignment.



0.5 m/s is the default alignment velocity. If a different alignment velocity is required, it can be changed using the **SETALIGNMENTVEL** command. Refer to the [OEM7 Commands and Logs Reference Manual](#) for more information.

While it is possible to lower the minimum speed required for kinematic alignment to take place, the higher the value, the more closely the course-over-ground estimate will match the vehicle heading.

The accuracy of the initial attitude of the system following the kinematic alignment varies and depends on the dynamics of the vehicle. The attitude accuracy will converge to within specifications once some motion is observed by the system. This transition can be observed by monitoring the INS Status field in the INS logs.

## Dual antenna alignment

SPAN can also use heading information available from a NovAtel Dual Antenna ALIGN solution to rapidly perform an alignment.

## NVM seeded alignment

SPAN can use the alignment information from a previous power up to quickly perform an alignment. For information about enabling and using an NVM Seeded Alignment, refer to *INS Seed / Fast INS initialization* on page 81.

## Manual alignment

If the initial azimuth of the system is known, it can be entered manually using the **SETINITAZIMUTH** command. Refer to the [OEM7 Commands and Logs Reference Manual](#) for more information about this command.

**A manual alignment should be used only if the azimuth is accurately known.**

## Configuring SPAN alignment method

The SPAN-enabled receiver can be configured for different alignment routines depending on the motion conditions experienced during the alignment period. For example, in marine applications, the dynamics required for either a static coarse or kinematic alignment cannot be guaranteed, so a different alignment routine will be required. This is achieved with the **ALIGNMENTMODE** command.

**NVM Seeded alignment and Manual alignments are valid for all alignment modes and will supersede all other options if valid and available.**

### Automatic alignment mode (default)

The automatic alignment mode is the default setting for a SPAN-enabled receiver. This mode is designed to allow alignment of the system as quickly as possible, using any of the alignment methods (Static Coarse, Kinematic, NVM Seeded, Dual Antenna or Manual), regardless of its relative quality. No additional configuration is required to use this alignment routine. If a specific alignment technique is desired, it must be selected manually to guarantee that alignment method.

### Unaided alignment mode

The unaided alignment mode sets the SPAN system to use only single antenna and superseding alignment options (Static Coarse, Kinematic, NVM Seeded or Manual alignment).

To use this alignment mode, the **ALIGNMENTMODE** command must be sent to the receiver.

```
ALIGNMENTMODE UNAIDED
```

### Aided transfer alignment mode

The aided transfer alignment mode sets the SPAN system to use only dual antenna and superseding alignment options (Dual Antenna, NVM Seeded or Manual alignment).

This alignment routine is the preferred dual antenna alignment method.

If the vehicle is not stationary during the alignment, such as may be the case on a ship, use the Aided Transfer Alignment routine. This alignment method uses the ALIGN baseline solution to perform an instantaneous alignment of the vehicle azimuth.

The alignment happens instantaneously after the receiver establishes communication with the IMU and computes a verified, fixed integer, ALIGN solution.

To guarantee the use of this alignment mode, the **ALIGNMENTMODE** command must be sent to the receiver:

```
ALIGNMENTMODE AIDED_TRANSFER
```

### Static coarse alignment mode

The static coarse alignment mode sets the SPAN system to use only static coarse and superseding alignment options (Static Coarse, NVM Seeded or Manual alignment).

To guarantee the use of this alignment mode, the **ALIGNMENTMODE** command be sent to the receiver:

```
ALIGNMENTMODE STATIC
```

### Kinematic alignment mode

The kinematic alignment mode sets the SPAN system to use only kinematic and superseding alignment options (Kinematic, NVM Seeded or Manual alignment).

To guarantee the use of this alignment mode, the **ALIGNMENTMODE** command must be sent to the receiver:

```
ALIGNMENTMODE KINEMATIC
```

## 4.6.2 INS Seed / Fast INS initialization

The INS Seed functionality is an alignment method whereby INS alignment information from a previous powerup can be injected into the system at startup to achieve an INS alignment more quickly. This is especially useful for systems that previously required a kinematic alignment.

When INS Seed is enabled, alignment data is automatically saved when appropriate, with no specific action required from the user. During subsequent power ups, the saved solution is compared to the current position of the system, and if valid, the saved solution is used to immediately initialize the inertial filter, making it ready for use.

Error model information is also saved with the seed data. Even if full alignment cannot be achieved, this information will still be used to aid filter convergence, although another method of alignment will be required.

This feature is enabled via the **INSSEED** command. This command setting must be saved to NVM via the **SAVECONFIG** command to be used upon next system boot-up.



When the INS Seed functionality is enabled, it will most often be the first available alignment method and therefore the used alignment method. If Dual Antenna Alignment is desired, consider disabling INSSEED. See *System start-up and alignment techniques* on page 77 for more details.

### Criteria

For the INS seed functionality to be enabled, the **INSSEED ENABLE** command must be sent.

### Saving

The following criteria must be met for valid alignment data to be saved into receiver NVM.

- The INS solution status must be converged, as indicated by the INS solution convergence flag in the inertial Extended Solution Status.
- The system velocity is less than 0.2 m/s.

When these conditions are met, the required information is automatically saved to NVM. If these conditions cease to be met, the saved alignment data is automatically discarded. If the alignment data is discarded, error model information is automatically retained as appropriate.

### Use at boot-up

Upon boot, several checks are done to verify that any seed data existing in NVM is appropriate for use. These checks require a GNSS position to be computed, so an NVM seed will never be injected prior to achieving a GNSS position. The following criteria must be met in order to use a seed:

- Seed data from NVM must be valid
- The system must be stationary
- The system must not have moved significantly from the seed position: less than 10 metres in position and 10 degrees in heading

If a valid error model is present in the seed data from NVM, this will always be used, even if the system is not stationary or exceeded the movement thresholds.

### INJECT Option (Advanced Users Only)

There is an advanced option available to skip the second and third validation steps described in the boot-up section above. This can be used if GNSS is not available on power-up or if speed to achieve an alignment is imperative.

This option is for advanced users only. Forcing an injection of an NVM seed without the validation checks can cause an unstable INS solution if the vehicle has moved.

Apart from injecting the seed at start-up without validation, this will also remove some requirements typically asserted to allow the filter to converge. This will allow the system to run without GNSS adequately at start-up.

### Example usage

Enabling functionality after FRESET:

1. Send the following command.

```
INSSEED ENABLE VALIDATE
```

2. Send the following command.

```
SAVECONFIG
```

Saving valid INS information:

1. Operate the system as normal, until the filter completes convergence.
2. Bring the system to a complete stop before powering off or resetting.

Using valid INS information on start-up:

1. Remain static while initializing.
2. Wait for the system to receive a valid position from GNSS.
3. If valid, alignment data will be injected.

### System indicators

The **INSSEEDSTATUS** log reports the seed injection status for the current power up and information on current seed validity. Refer the [OEM7 Commands and Logs Reference Manual](#) for more information about the **INSSEEDSTATUS** log.

The Extended Solution Status field in the **INSPVAX** log has bits that indicate if the alignment direction is verified, the Alignment type that occurred and NVM seed injection status.

#### Alignment direction verified: Bit 25

This bit indicates whether the alignment is verified or not. When the seed is injected and kinematic validation is finished, bit 25 is set to 1. Note that this bit will not be set until the kinematic validation completes. When the INJECT option is used, validation is skipped and this bit will not be set.

#### Alignment type: Bits 26-28

These bits indicate how the INS system reached INS\_ALIGNMENT\_COMPLETE. When the INS system aligns using saved INS solution data from NVM, bits 26-28 will be set to 101

#### NVM seed status: Bits 29-31

These bits indicate the current status of the seeding process at start-up, as described in the table below:

**Table 11: NVM seed indication**

Bit 31-29 values <sup>1</sup>	Hex value	NVM seed type
000	0x00	INS Seed has not been injected into the solution
001	0x01	Valid INS Seed was not found in non-volatile memory
010	0x02	INS Seed has failed validation and has been discarded
011	0x03	INS Seed is awaiting validation
100	0x04	INS Seed alignment data has successfully been injected (including error model data)
101	0x05	INS Seed exists, but has been ignored due to a user commanded filter reset/restart or configuration change
110	0x06	INS Seed error model data has successfully been injected

### 4.6.3 Navigation mode

Once the alignment routine has successfully completed, SPAN enters navigation mode.

SPAN computes the solution by accumulating velocity and rotation increments from the IMU to generate position, velocity and attitude. SPAN models system errors by using a filter. The GNSS solution, phase observations and automatic zero velocity updates (ZUPTs) provide updates to the filter. Peripheral updates can also be supplied; an external receiver for heading updates.

Following the alignment, the attitude is coarsely defined, especially in heading. Vehicle dynamics, specifically turns, stops and starts, allow the system to observe the heading error and allows the heading accuracy to converge. The amount of dynamics required for filter convergence vary by the alignment quality, IMU quality, and maneuvers performed. The INS Status field changes to INS\_SOLUTION\_GOOD once convergence is complete. If the filter degrades in its system accuracy, the INS Status field changes to INS\_HIGH\_VARIANCE. When the accuracy converges again, the INS status continues as INS\_SOLUTION\_GOOD.

While in navigation mode (in firmware versions 7.09.00 or greater), SPAN operates an internal secondary INS filter for built-in redundancy and reliability. When a verified GNSS solution of sufficient quality is available, the primary and secondary filters are validated against the GNSS solution. If divergence between the primary filter and the GNSS solution is detected, SPAN position, velocity and attitude output will fall back to using the secondary filter solution. This allows the system to reinitialize the primary filter if the divergence cannot be recovered, without interruption to the system's position, velocity and attitude output. Once the primary INS filter returns to normal operation (through recovery or reinitialization), the INS solution will revert back to the primary filter.

The system will flag bit 22 of the INS Extended Solution Status (see the [OEM7 Commands and Logs Reference Manual](#)) to indicate whenever the secondary INS solution is in use.

### 4.6.4 Data collection

The INS solution is available in the INS-specific logs with either a standard or short header. Other parameters are available in the logs shown in *Table 12: Solution parameters* on the next page:

1. The values from left to right are Bit 31, Bit 30 and Bit 29.

**Table 12: Solution parameters**

Parameter	Logs	
Position	INSPOS or INSPOSS INSPVA or INSPVAS	INSPOSX or INSPVAX
Velocity	INSVEL or INSVELS INSSPD or INSSPDS INSPVA or INSPVAS	INSVELX or INSPVAX
Attitude	INSATT or INSATTS INSPVA or INSPVAS	INSATTX or INSPVAX
Solution Uncertainty	INSSTDEV or INSSTDEVS	



The **INSATTX** log, **INSPOSX** log, **INSPVAX** log and **INSVELX** log contain solution and variance information and are therefore large logs. Use a low logging rate (<20 Hz) only. These logs also contain solution uncertainty in standard deviation format.

Note that the position, velocity and attitude are available together in the **INSPVA** log, **INSPVAS** log and **INSPVAX** log.

The inertial solution is available up to a rate of 200 Hz. Data can be requested at a specific synchronous time interval, asynchronously matching the IMU output rate, or can be triggered by the mark input trigger at rates up to 200 Hz.

The GNSS-only solution is still available through the GNSS-only logs such as RTKPOS and PSRPOS. Refer to the [OEM7 Commands and Logs Reference Manual](#). INS-only data logging and output can be at rates of up to the rate of the IMU data.



The highest rate that you should request GNSS logs (RANGE, BESTPOS, RTKPOS, PSRPOS, and so on) while in INS operation is 5 Hz. If the receiver is not running INS (no IMU is attached), GNSS logs can be requested at rates up to 20 Hz.



### Logging restriction important notice

Logging excessive amounts of high rate data can overload the system. When configuring the output for SPAN, NovAtel recommends that only one high rate (>50 Hz) message be configured for output at a time. It is possible to log more than one message at high rates, but doing so could have negative impacts on the system. Also, if logging 100/200 Hz data, always use the binary format and, if possible, the short header binary format (available on most INS logs).

For optimal performance, log only one high rate output at a time. These logs could be:

- Raw data for post processing  
RAWIMUXSB ONNEW
  - RAWIMU logs are not valid with the ONTIME trigger. The raw IMU observations contained in these logs are sequential changes in velocity and rotation. As such, you can only use them for navigation if they are logged at their full rate. Refer to the [OEM7 Commands and Logs Reference Manual](#) for log and command details.
- Real time INS solution  
IMURATEPVA ONNEW or IMURATEPVAS ONNEW
  - Other possible INS solution logs available at high rates are: INSPVASB, INSPOSSB, INSVELSB, INSATTSB

Specific logs need to be collected for post-processing. See *Data collection for post processing* on page 90.

To store data from an OEM7 receiver, connect the receiver to a computer running NovAtel Application Suite or other terminal program capable of recording data.

### 4.6.5 Recommended messages to be logged for SPAN data collection

Although every customer has a different application and setup, it is important to always log as much information about the GNSS and INS filters and the environment in which the survey is taking place. The following are the suggested messages that should be logged for every survey. Note that the list includes all necessary messages for post-processing in Inertial Explorer.

#### Recommended SPAN messages for OEM7

- LOG VERSIONB ONCHANGED
- LOG RXCONFIGB ONCE
- LOG RXSTATUSB ONCHANGED
  
- LOG RANGE B ONTIME 0.5
- LOG GPSEPHEMB ONALL<sup>1</sup>
- LOG GLOEPHEMERISB ONALL<sup>2</sup>
- LOG GALFNAVEPHEMERISB ONALL<sup>3</sup>
- LOG GALINAVEPHEMERISB ONALL<sup>2</sup>

1. For firmware version earlier than 7.09.01, use the ONNEW trigger.

2. Should be logged if tracking GLONASS. For firmware version earlier than 7.09.01, use the ONNEW trigger.

3. Should be logged if tracking Galileo. For firmware version earlier than 7.09.01, use the ONNEW trigger.

- LOG BDSEPPHEMERISB ONALL<sup>1</sup>
- LOG QZSSEPPHEMERISB ONALL<sup>2</sup>
- LOG NAVICEPPHEMERISB ONALL<sup>3</sup>
- LOG BESTGNSSPOSB ONTIME 1
- LOG BESTGNSSVELB ONTIME 1
- LOG BESTPOSB ONTIME 1
- LOG RANGE\_1 ONTIME 0.5<sup>4</sup>
  
- LOG HEADING2B ONNEW<sup>6</sup>
- LOG RAWIMUSXB ONNEW
- LOG INSPVAXB ONTIME 1
- LOG INSCONFIGB ONCHANGED<sup>5</sup>
- LOG INSUPDATESTATUSB ONNEW
- LOG DMICONFIGB ONCHANGED<sup>6</sup>
- LOG RAWDMIB ONNEW<sup>8</sup>

#### 4.6.6 Body to vehicle frame rotation calibration routine

Kinematic alignment requires that the rotational offset between the vehicle and IMU Body frame (RBV) is known. If the angles are simple (that is, a simple rotation about one axis) the values can easily be entered manually through the **SETINSROTATION RBV** command. If the rotational offset is more complex (that is, rotation is about 2 or 3 axis), then the calibration routine provides a more accurate estimation of the values.

The steps for the calibration routine are:

1. Apply power to the SMART7.
2. Configure the SPAN system including an approximate IMU Body to Vehicle frame (RBV) rotation. See *SPAN configuration for SMART7-S* on page 75.
3. Ensure that an accurate lever arm has been entered into the system.
4. Perform an initial system alignment using one of the methods described in *System start-up and alignment techniques* on page 77. Ensure the system reaches Solution Good.
5. Enable calibration using the **INSCALIBRATE** command with an optional standard deviation target.

```
INSCALIBRATE RBV NEW [target_stdev]
```

6. To monitor the calibration, log INSCALSTATUS using the ONCHANGED trigger.
7. Start to move the system. Movement of the system is required for the observation of the angular offsets.

- 
1. Should be logged If tracking BeiDou. For firmware version earlier than 7.09.01, use the ONNEW trigger.
  2. Should be logged If tracking QZSS. For firmware version earlier than 7.09.01, use the ONNEW trigger.
  3. Should be logged If tracking NavIC. For firmware version earlier than 7.09.01, use the ONNEW trigger.
  4. Should be logged If using dual antennas.
  5. Can change ONCHANGED to ONTIME 600 to ensure the message is recorded.
  6. Should be logged if using DMI.

Drive a straight course on level ground (remember that most roads have a crown resulting in a constant roll of a few degrees). Avoid driving on a surface with a constant, non-zero, slope to prevent biases in the computed angles. Vehicle speed must be greater than 5 m/s (18 km/hr) for the calibration to complete.

8. When the calibration is complete, either because the accuracy requirement has been met, or the calibration been stopped by user command (**INSCALIBRATE** command), the calibrated offset value is automatically applied can be viewed in either the **INSCALSTATUS** log or the **INSCONFIG** log.

To save a calibrated rotation for subsequent start ups, issue the **SAVECONFIG** command after calibration is complete. Each time the IMU is re-mounted this calibration should be performed again. See also *Kinematic alignment* on page 79 for details on kinematic alignment.



**After the INSCALIBRATE RBV ENABLE command is entered, there are no body-vehicle rotation parameters present and a kinematic alignment is NOT possible. Therefore this command should only be entered after the system has performed a kinematic alignment and has a valid INS solution.**



As with the **SETINSROTATION** command, the minimum standard deviation that will be applied is 0.25 degrees (as viewed in the **INSCONFIG** log), even though the **INSCALSTATUS** log may report lower standard deviations after a successful calibration.



For information about the logs and commands used in this procedure, refer to the [OEM7 Commands and Logs Reference Manual](#).

#### 4.6.7 Multi-line body to vehicle frame rotation calibration routine

The single pass Body to Vehicle frame offset calibration feature assumes flat ground when estimating the roll offsets between the IMU Body and Vehicle frames, as this component of the rotational offset is difficult to observe through typical ground vehicle motion. In practice this can result in an outstanding roll offset error as high as several degrees. For applications where vehicle roll must be well known, or pass-to-pass accuracy of a highly offset position is especially important, the Multi-Line IMU Body to Vehicle frame offset calibration routine offers higher calibrated accuracy in roll. This is done by running independent calibrations over the same ground path in opposite directions; averaging the results cancels out the effect of any terrain induced roll. A minimum of two iterations are required. Additional iteration pairs can be executed for increased reliability.

Figure 26: Multi-line IMU body to vehicle calibration

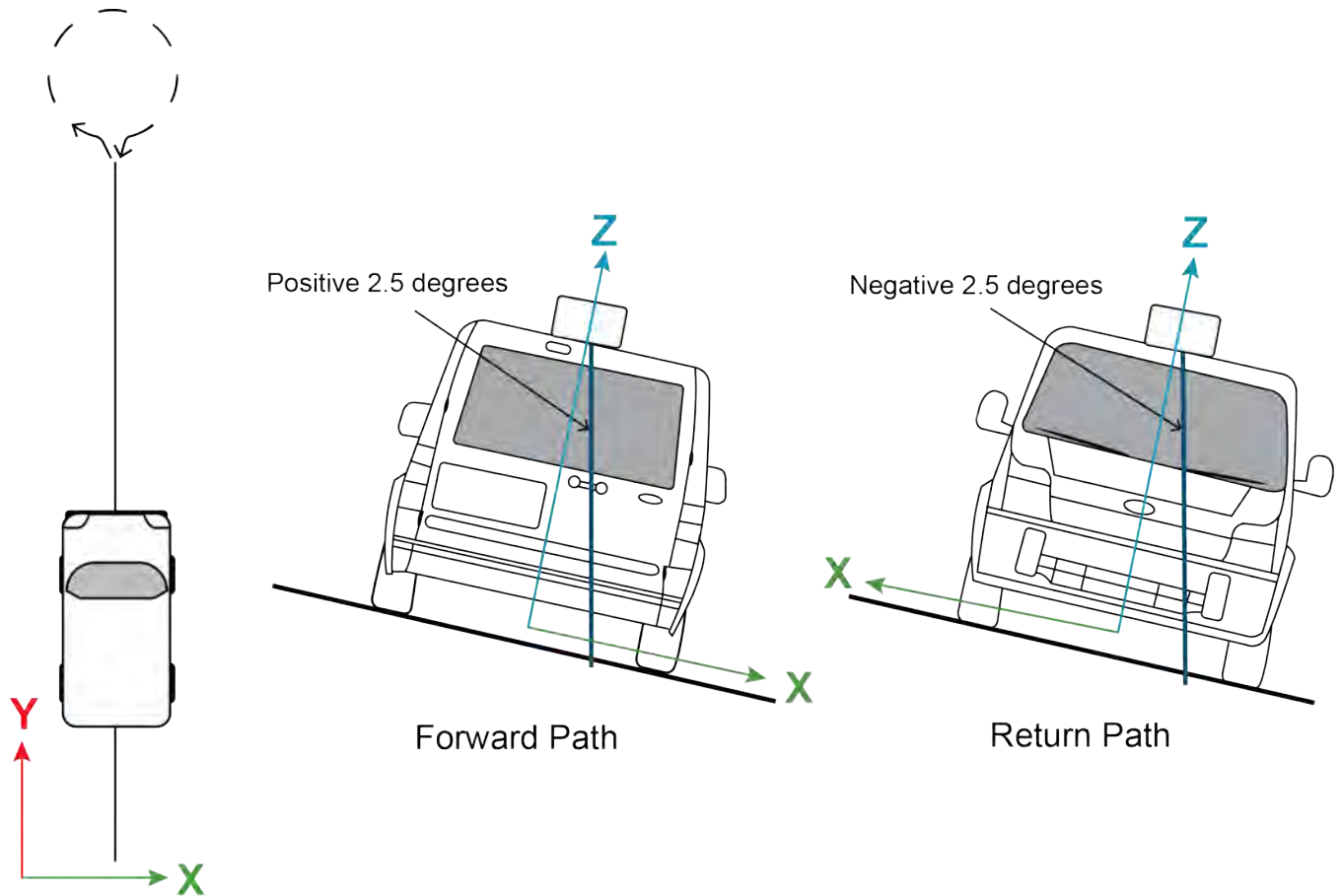

The steps for the calibration routine are:

1. Apply power to the SMART7.
2. Configure the SPAN system, see *SPAN configuration for SMART7-S* on page 75.
3. Perform an initial system alignment using one of the methods described in *System start-up and alignment techniques* on page 77. Ensure the system reaches Solution Good.
4. Enable a new calibration using the **INSCALIBRATE** command, with the optional standard deviation target omitted:

```
INSCALIBRATE RBV NEW
```

5. Start to move the vehicle. Drive a straight course, at a vehicle speed greater than 5 m/s (18 km/hr). A distance of approximately 250 metres is recommended.

To monitor the calibration, log **INSCALSTATUS** using the ONCHANGED trigger.

6. When the end of the available distance is reached, stop the vehicle. Halt the ongoing calibration by sending the **INSCALIBRATE** command again:

```
INSCALIBRATE RBV STOP
```

7. At this point **INSCALSTATUS** will report a source status of CALIBRATED. Turn the vehicle around and come to a stop on the finishing point of the previous line.
8. Initiate the second pass of the calibration by issuing the **INSCALIBRATE** command with the **ADD** parameter:

## INSCALIBRATE RBV ADD

9. Drive the vehicle back along the original course, until you reach the starting point for the first pass. Stop the vehicle, and re-issue the **INSCALIBRATE** command, with the **STOP** parameter. **INSCALSTATUS** will again indicate a source status of CALIBRATED.

At this point the Multi-Line calibration can be considered complete, but more iterations can be repeated until the desired accuracy level is reached.

At any point during an active calibration line, the **INSCALIBRATE** command, with the **RESET** parameter can be used to reset the calibration. This will ensure that the results of the active line are not added to the Multi-Line calibration. The **INSCALSTATUS** log will restore the previous source status and calibration values.

10. When the calibration is complete, the calibrated offset value can be viewed in either the **INSCALSTATUS** log or the **INSCONFIG** log.

To save a calibrated rotation for subsequent start ups, issue the **SAVECONFIG** command after calibration is complete. Each time the IMU is re-mounted this calibration should be performed again.



**Do not start INS Calibrations (NEW or ADD) until the inertial alignment is completed and system has converged.**



For information about the logs and commands used in this procedure, refer to the [OEM7 Commands and Logs Reference Manual](#).

## 4.7 Azimuth sources on a SPAN system

The SPAN system use three different methods to calculate the azimuth.

- Course over ground
- Inertial azimuth
- ALIGN azimuth

### 4.7.1 Course over ground

The course over ground azimuth is determined using the position delta between two position solutions computed by the OEM7 receiver. This is the simplest way to compute an azimuth and is done using either the GNSS solution or the INS solution. This method does not work when the vehicle is stationary as any position difference is due to position error and the computed azimuth is meaningless.

Course over ground azimuth is of greatest advantage in aerial or marine environments where the actual direction of travel may not match the forward axis of the aircraft/boat due to winds or currents. This effect is known as the crab angle. Course over ground azimuth is a great way to compute the offset if another means of computing the vehicle azimuth is available.

Course over ground azimuths are available in several different velocity logs. See *Table 13: Logs with azimuth data* on the next page.

### 4.7.2 Inertial azimuth

The inertial azimuth computed by the SPAN inertial navigation filter. It uses the sensors in the IMU to compute the azimuth of the IMU (this can be rotated to another reference if desired). For more information, see the **SETINSROTATION** command in the [OEM7 Commands and Logs Reference Manual](#).

This azimuth is the one provided in the majority of the INS logs available to a SPAN user. See *Table 13: Logs with azimuth data* below.

### 4.7.3 ALIGN azimuth

On SPAN systems with dual antennas, an azimuth is available from the dual antenna baseline. This is the same azimuth that is used as an update to the SPAN solution. It is noisier than the inertial azimuth and is available at a much lower rate, but will have a stable mean. This azimuth is computed from the base antenna to the rover antenna based on how the antennas are oriented on the vehicle.

There is a specific subset of logs that output this azimuth. See *Table 13: Logs with azimuth data* below.

**Table 13: Logs with azimuth data**

Log	Log format	Azimuth source
BESTGNSSVEL	NovAtel	Course over ground From the best GNSS only solution
BESTVEL	NovAtel	Course over ground From the best system solution which could be either GNSS or INS
GPHDT	NMEA	ALIGN
GPVTG	NMEA	Course over ground From the best system solution which could be either GNSS or INS
HEADING2 / DUALANTENNAHEADING	NovAtel	ALIGN
INSATT / INSATTS / INSATTX	NovAtel	Inertial
INSPVA / INSPVAS / INSPVAX	NovAtel	Inertial
INSSPD	NovAtel	Course over ground Computed using the INS solution only
PASHR	NMEA	Inertial

## 4.8 Data collection for post processing

Some operations, such as aerial measurement systems, do not require real-time information from SPAN. These operations are able to generate the position, velocity or attitude solution post-mission in order to generate a more robust and accurate solution than is possible in real-time.

In order to generate a solution in post-processing, data must be simultaneously collected at a base station and each rover. The following logs must be collected in order to successfully post process data.

From a base:

- LOG VERSIONB ONCE
- LOG RXCONFIGB ONCE
- LOG RXSTATUSB ONCHANGED

- LOG THISANTENNATYPEB ONCE
- LOG RANGECMPB ONTIME 1
- LOG RANGECMPB\_1 ONTIME 1
- LOG GPSEPHSEMB ONNEW
- LOG GLOEPHEMERISB ONNEW (if using GLONASS)
- LOG GALINAVEPHEMERISB ONNEW (if using Galileo)
- LOG GALFNAVEPHEMERISB ONNEW (if using Galileo)
- LOG BDSEPHHEMERISB ONNEW (if using BeiDou)
- LOG QZSSEPHHEMERISB ONNEW (if using QZSS)

From a rover:

- LOG VERSIONB ONCE
- LOG RXCONFIGB ONCE
- LOG RXSTATUSB ONCHANGED
- LOG THISANTENNATYPEB ONCE
- LOG HEADING2B ONNEW
- LOG INSCONFIGB ONCHANGED
- LOG RANGECMPB ONTIME 1
- LOG GPSEPHSEMB ONNEW
- LOG GLOEPHEMERISB ONNEW (if using GLONASS)
- LOG GALINAVEPHEMERISB ONNEW (if using Galileo)
- LOG GALFNAVEPHEMERISB ONNEW (if using Galileo)
- LOG BDSEPHHEMERISB ONNEW (if using BeiDou)
- LOG QZSSEPHHEMERISB ONNEW (if using QZSS)
- LOG RAWIMUSXB ONNEW
- LOG TIMEB ONTIME 1
- LOG BESTPOSB ONTIME 1
- LOG BESTGNSSPOSB ONTIME 1
- LOG INSPVAXB ONTIME 1
- LOG INSUPDATESTATUSB ONCHANGED
- LOG DMICONFIGB ONCHANGED (if using a DMI sensor)
- LOG RAWDMIB ONNEW (if using a DMI sensor)

Post processing is performed using Waypoint Inertial Explorer. Visit our web site at [novatel.com/products/waypoint-software](http://novatel.com/products/waypoint-software) for details.



The highest rate that you should request GNSS logs (RANGE, BESTPOS, RTKPOS, PSRPOS, and so on) while in INS operation is 5 Hz. If the receiver is not running INS (no IMU is attached), GNSS logs can be requested at rates up to 20 Hz.



The choice between ONNEW and ONCHANGED is dependent on the type of data collection and user preferences. The ONNEW trigger can result in larger files with duplicate logs that are ignored by Inertial Explorer's converter. The ONCHANGED trigger is preferable to avoid duplicates and minimize file size. However, if the ONCHANGED log request is made before the logging file is opened the log will not be triggered until a value has changed. This may cause issues in short surveys, as slow changing logs (such as RAWEPHEMB) may not be logged during the data collection period. For this reason, ONNEW is suggested for short surveys.



No RAWDMIB logs will be decoded without the presence of a DMICONFIGB log. As such, users may consider logging this ONTIME at a coarse rate to ensure it is saved to file (e.g. LOG DMICONFIGB ONTIME 300).

## Chapter 5 Wi-Fi configuration

Wi-Fi is a Wireless Local Area Network (WLAN) used to exchange data wirelessly over a computer network.

The SMART7-I, SMART7-SI and SMART7-W have a Wi-Fi transceiver that works as a 2.4 GHz 802.11 Access Point (AP). On startup, the SMART7 automatically configures itself as an AP. The Wi-Fi AP is configured with the settings shown in *Table 14: Wi-Fi default configuration* below and is enabled when the SMART7 is powered on. The default AP configuration can be overridden using the **WIFIMODE** command and **SAVECONFIG** command. Refer to the [OEM7 Commands and Logs Reference Manual](#) for command details.

The SMART7 supports three modes of operation plus On and Off.

By default, the SMART7 is configured to run as a 2.4 GHz 802.11 Access Point (AP) capable of accepting up to four client connections.

When the SMART7 starts up, the AP starts automatically with no special configuration required. The SSID and the password/passkey are printed on a label located by the connectors of the unit. The SSID is "SM7- <Receiver PSN>" (e.g. "SM7-ABCDEF12345678E").

Once a Wi-Fi connection is established, open a browser and navigate to the receiver's URL which is 192.168.19.1 by default. The receiver Manage Web homepage opens.

In addition, it is possible to connect to an ICOM port by establishing a terminal connection to the receiver's IP address using TCP ports 3001 through 3007.

### 5.1 Wi-Fi modes

#### 5.1.1 Access Point (AP)

AP is the Wi-Fi default mode at start up. This mode is used by the SMART7 to wirelessly connect to devices defined as clients or concurrent. Refer to *Enable the Wi-Fi access point* on the next page for detailed instructions.

#### 5.1.2 Client

When in Client mode, the SMART7 can only communicate with APs. Refer to *Enable the Wi-Fi client* on the next page for detailed instructions.

#### 5.1.3 Concurrent

When set to Concurrent mode, the SMART7 can act as both an AP and a Client. Refer to *Enable the Wi-Fi concurrent* on page 96 for detailed instructions.



The term passkey and password are the same.

**Table 14: Wi-Fi default configuration**

Parameter	Default
Mode	AP

Parameter	Default
SSID	Printed on the SMART7 label ("SM7-<Receiver PSN>")
Passkey	Printed on the SMART7 label
Channel	11
IP address	192.168.19.1
Netmask	255.255.255.0

To view the current Wi-Fi settings, use the **WIFIAPSETTINGS** log. Refer to the [OEM7 Commands and Logs Reference Manual](#).

Also refer to *Wi-Fi changes* on page 97 for instructions on changing the various default settings. Refer to *ALIGN over Wi-Fi overview* on page 98 for instructions on configuring ALIGN corrections.

## 5.2 Wi-Fi modes

On start-up the SMART7 configures itself as an access point by default. This can be overridden with the **WIFIMODE** command and **SAVECONFIG** command. The **WIFIMODE** command supports three modes of operation (in addition to Off and On):

- *Enable the Wi-Fi access point* below
- *Enable the Wi-Fi client* below
- *Enable the Wi-Fi concurrent* on page 96



The term passkey and password are the same.

### 5.2.1 Enable the Wi-Fi access point



By default, the SMART7 is an Access Point.

1. Start a command line interface (CLI) session with the receiver.  
Use a Ethernet or Serial (COM) port connection.
2. Use the **WIFIMODE** command to enable the Wi-Fi transceiver as an AP.

```
WIFIMODE AP
```

3. Use the **SAVECONFIG** command to store the change in Non-Volatile Memory.  
This ensures the changes are kept when the receiver is restarted.

The SMART7 has the ability to override the Access Point SSID to the existing Access Point. By default, the SSID is the enclosure PSN prefixed by 'SM7-' (e.g. SM7-NMPX17500010L). Refer to *Change the SSID* on page 97 for detailed instructions.

### 5.2.2 Enable the Wi-Fi client

The SMART7 can also be configured as a client/station capable of connecting to an access point such as another SMART7 receiver. The primary reason for configuring a SMART7 receiver as a client is to allow the

transmission of corrections from one receiver to another over Wi-Fi.

**Prior to connecting to an Access Point, note the following information found on the receiver label:**

**The SSID in the form "SM7-<Receiver PSN>" (e.g. "SM7-ABCDEF1234567").**

**The Wi-Fi password (also known as passkey).**

The information for up to four Access Points can be stored in the SMART7 using the **WIFINETCONFIG** command.

To configure the SMART7 as a client and connect it to an access point, follow these steps:

1. Start a command line interface (CLI) session with the receiver.  
Use a Ethernet or Serial (COM) port connection.
2. Use the **WIFIMODE** command to enable the Wi-Fi transceiver as a Client.

```
WIFIMODE CLIENT
```

3. Configure the SMART7 as a Client to connect to the desired access point by issuing:

```
WIFINETCONFIG 1 ENABLE "<ssid>" "<password>"
```

Where <ssid> and <password> are the SSID and password of the Access Point to which the Client should connect. The "1" can be a value of 1-4 depending on the Access Point being configured.

4. Use the **SAVECONFIG** command to store the change in Non-Volatile Memory.  
This ensures the changes are kept when the receiver is restarted.

The receiver will automatically connect to the access point (if it is in range).

The connection status of the receiver can be monitored by entering the following command and waiting for it to report **CONNECTED\_TO\_AP**

```
LOG WIFISTATUS ONCHANGED
```

The access points in range can be monitored by entering this command:

```
LOG WIFINETLIST ONCHANGED
```

A SMART7 operating as a client can be configured to automatically connect to one of several Access Points which may or may not be another receiver. This functionality is similar to what is provided by Smart phones which automatically connect to known Access Points. In the case of the SMART7, each access point is assigned a network id value so that when more than one Access Point is in range, the client connects to the Access Point with the lowest network ID.

The command to do this is **WIFINETCONFIG** command:

```
WIFINETCONFIG <network_id> <enabled> <ssid> <passkey> <dhcp_mode> <ip_<br>address> <netmask> <gateway> <dns>
```



If the **WIFIALIGNAUTOMATION** command is enabled, the only Access Point the Client will connect to is the ALIGN Base Access Point.

When configured for Client Mode, the SMART7 initiates background scanning to periodically receive a list of nearby Access Points. Whenever a list of Access Points is received they are published in the **WIFINETLIST** log. If the Client is not currently connected to an Access Point, the list of available Access Points is compared to the Access Point specified by the **WIFIALIGNAUTOMATION** command or the list of Access Points in the

**WIFINETCONFIG** command and automatically establishes a connection. If there is more than one match, the Client automatically connects to the Access Point with the lowest network ID.

### 5.2.3 Enable the Wi-Fi concurrent

When operating in Concurrent mode, the receiver acts as both a Wi-Fi client and an access point at the same time. This makes it possible to configure the receiver using either the Manage Web or an ICOM port in the event that the receiver is unable to establish a connection to any of its preconfigured access points.

When configured as a Client, communication with the receiver is limited to either physical communications such as serial or Ethernet or through the Access Point to which it is connected. This can be problematic if none of the access points stored in the receiver are in range. To ensure the receiver is accessible over a Wi-Fi connection, it is possible to configure it in Concurrent mode, which allows it to operate as both an access point (for configuration/monitoring purposes) and as a Client (for the transfer of corrections).

1. Start a command line interface (CLI) session with the receiver.  
Use a Ethernet or Serial (COM) port connection.
2. Use the **WIFIMODE** command to enable the Wi-Fi transceiver in concurrent mode. The SMART7 automatically connects to any Access Point in range which has been stored in the receiver with **WIFINETCONFIG** command and also accepts up to four incoming client connections.

```
WIFIMODE CONCURRENT
```

3. Use the **SAVECONFIG** command to store the change in Non-Volatile Memory.  
This ensures the changes are kept when the receiver is restarted.

If the Access Point chosen by the Concurrent Client is using a channel different than the one used by the Concurrent Access Point, the Wi-Fi module will be rebooted and configured to use the channel of the chosen access point. Any clients connected to the Concurrent Mode Access Point will lose their connection and may or may not automatically reconnect.

If the access point chosen by the Client is configured with the same IP address as the Concurrent Access Point, communication with the chosen access point will be blocked. To detect this situation, check the **IPSTATUS** log to verify that the IP address of the Concurrent Access Point is different than the Gateway IP address assigned to the Concurrent Client. To correct this situation, the IP address of the Concurrent Access Point should be updated using the **WIFIAPCONFIG** command followed by the **WIFIMODE CONCURRENT** command. In the example below, the IP address of the Concurrent Access point is changed from 192.168.19.1 to 192.168.20.1 to enable a communication path between the two receivers to be established.

```
WIFISTATUS COM1 0 74.0 FINESTEERING 2011 337605.032 02000000 8a58 32768
CONCURRENT_CONNECTED_TO_AP "SM7-NMPX18070011D" -31 11 "88:da:1a:04:c5:0c" WPA2 0

log ipstatus

IPSTATUS COM1 0 75.5 FINESTEERING 2011 337611.000 02000000 7fe2 32768
3
  ETHA "10.129.32.50" "255.255.255.0" ""
  WIFI "192.168.19.1" "255.255.255.0" ""
  WIFI_CLIENT "192.168.19.100" "255.255.255.0" "192.168.19.1"
  1
  "192.168.19.1"

wifiapconfig 192.168.20.1 255.255.255.0

wifimode concurrent

log ipstatus

IPSTATUS COM1 0 75.0 FINESTEERING 2011 337726.000 02000000 7fe2 32768
3
```

```
ETHA "10.129.32.50" "255.255.255.0" ""
WIFI "192.168.20.1" "255.255.255.0" ""
WIFI_CLIENT "192.168.19.100" "255.255.255.0" "192.168.19.1"
1
"192.168.19.1"
```

## 5.3 Wi-Fi changes

Various default Wi-Fi settings on the SMART7 can be changed and Wi-Fi can be disabled.

### 5.3.1 Change the Wi-Fi passkey



The term passkey and password are the same.

1. Start a CLI session with the receiver.  
Use a Ethernet or Serial (COM) port connection.
2. Use the **WIFIAPPASSKEY** command to change the Wi-Fi passkey.

```
WIFIAPPASSKEY NewPasskey
```

The new passkey must be a null terminated ASCII string that is 8 to 64 characters long.



The passkey will not change until the Wi-Fi transceiver has been restarted.

3. Use the **WIFIMODE** command to restart the Wi-Fi transceiver.  

```
WIFIMODE AP
```
4. Use the **SAVECONFIG** command to store the change in Non-Volatile Memory.  
This ensures the new passkey is kept when the receiver is restarted.

### 5.3.2 Change the SSID

Use the **WIFIAPSSID** command to change the default SSID if required.

```
WIFIAPSSID <ssid>
```

Issue the **SAVECONFIG** command and restart the receiver to change the SSID.

### 5.3.3 Change the Wi-Fi channel

1. Start a CLI session with the receiver.  
Use a Ethernet or Serial (COM) port connection.
2. Use the **WIFIAPCHANNEL** command to change the Wi-Fi channel.

```
WIFIAPCHANNEL 3
```

The channel must be a number from 1 to 14.



The Wi-Fi channel will not change until the Wi-Fi transceiver has been restarted.

3. Use the **WIFIMODE** command to restart the Wi-Fi transceiver.

```
WIFIMODE AP
```

4. Use the **SAVECONFIG** command to store the change in Non-Volatile Memory. This ensures the new channel is kept when the receiver is restarted.

### 5.3.4 Change the Wi-Fi IP address

1. Start a CLI session with the receiver. Use a Ethernet or Serial (COM) port connection.
2. Use the **WIFIPIPCONFIG** command to change the Wi-Fi IP address and netmask.

```
WIFIPIPCONFIG xxx.xxx.xxx.xxx yyy.yyy.yyy.yyy
```

In the command above xxx.xxx.xxx.xxx represents the IP address and yyy.yyy.yyy.yyy represents the netmask. For example:

```
WIFIPIPCONFIG 192.162.55.20 255.255.0.0.
```



The Wi-Fi IP address and netmask will not change until the Wi-Fi transceiver has been restarted.

3. Use the **WIFIMODE** command to restart the Wi-Fi transceiver.

```
WIFIMODE AP
```

4. Use the **SAVECONFIG** command to store the change in Non-Volatile Memory. This ensures the new IP address and netmask are kept when the receiver is restarted.

### 5.3.5 Disable Wi-Fi

1. Start a CLI session with the receiver. Use a Ethernet or Serial (COM) port connection.
2. Use the **WIFIMODE** command to disable the Wi-Fi transceiver.

```
WIFIMODE OFF
```

3. Use the **SAVECONFIG** command to store the change in Non-Volatile Memory. This ensures the changes are kept when the receiver is restarted.

## 5.4 ALIGN over Wi-Fi overview

On a SMART7, ALIGN can be configured over Wi-Fi by the following methods:

- *Automatic Wi-Fi ALIGN corrections* below
- *Manual set up for Wi-Fi connection between base and rover via ICOM1* on page 100

### 5.4.1 Automatic Wi-Fi ALIGN corrections

The **WIFIALIGNAUTOMATION** command is provided to simplify configuration of a pair of NovAtel Wi-Fi enabled receivers, one acting as an ALIGN Base and one acting as an ALIGN Rover.

The ALIGN Rover, acting as a Wi-Fi Client, connects to the specified Wi-Fi Access Point and configures it as the ALIGN Base. Use the **WIFIALIGNAUTOMATION** command to configure.

```
WIFIALIGNAUTOMATION <enable_disable> <base_networkid> <icom_port> <data_rate>  
<send_heading> <interface_mode>
```

Where:

- **enable\_disable** turns the feature on or off
- **base\_networkid** is the network ID associated with the SSID of the ALIGN Base as previously configured using the **WIFINETCONFIG** command.
- **icom\_port** is the ICOM port to be used for ALIGN corrections on both the Rover and the Base. It is assumed that the Base's ICOM port is configured with its factory default settings.
- **data\_rate** is as defined in the **ALIGNAUTOMATION** command.
- **interface\_mode** is as defined in the **ALIGNAUTOMATION** command.



The term passkey and password are the same.

If this feature is enabled and the **SAVECONFIG** command issued, when the Client is searching for an Access Point (either after startup or if the connection is lost), it will connect to the Access Point specified by <base\_networkid> even if another Access Point with a preferred network\_id (as entered by the **WIFINETCONFIG** command) is in range.



If interface\_mode is omitted, it is assumed that the ALIGN Base Access Point is already configured to transmit the desired corrections over the specified ICOM port.

Note that up to four rovers can be associated to the same Base, each using a different ICOM port.

#### Example:

Enable Wi-Fi ALIGN corrections using receiver SM7-NMND17190003B as the Base.

Using a serial port connected to the Client, enter the following commands:

```
WIFINETCONFIG 1 ENABLE SM7-NMND17190003B SM7_PWD
WIFIALIGNAUTOMATION ENABLE 1 ICOM5 20 ON NOVATELX
SAVECONFIG
```

Internally, the SMART7 client does the following:

- switches to Concurrent mode if currently configured as an Access Point or Client
- scans for available Access Points until SM7-NMND17190003B is detected
- connects to the SM7-NMND17190003B Access Point
- configures itself as follows:

```
ICOMCONFIG ICOM5 TCP 192.168.19.1:3005
INTERFACEMODE ICOM5 NOVATEL NOVATEL ON
```

- sends the following commands over ICOM5 to the Base:

```
UNLOGALL ICOM5 TRUE
MOVINGBASESTATION ENABLE
LOG ICOM5 NOVATELXOBS ONTIME .05
LOG ICOM5 NOVATELXREF ONTIME .05
INTERFACEMODE ICOM5 NOVATEL NOVATELX
```

- configures itself as follows:

```
INTERFACEMODE ICOM5 NOVATELX NOVATEL OFF
LOG ICOM5 HEADINGEXTB ONNEW
```

### 5.4.2 Manual set up for Wi-Fi connection between base and rover via ICOM1

In this setup, the ALIGN Rover acts as a Wi-Fi Client to the ALIGN Base which, by default, is configured as a Wi-Fi Access Point.

#### Configure ALIGN base

By default, the Base provides an Access Point with IP address of 192.168.19.1. No special configuration is required to enable this functionality. The only configuration required at the Base is to enable ALIGN corrections on ICOM1 as shown below:

```
interfacemode icom1 novatel novatelx off
movingbasestation enable
log icom1 novatelxobs ontime 1
log icom1 novatelxref ontime 1
log heading2a onnew
saveconfig
```

#### Configure ALIGN rover

The ALIGN Rover can be configured to connect to the Base Access Point over Wi-Fi using either DHCP (default) or by specifying static IP parameters. Configuration consists of the following steps:

1. Establish a Wi-Fi connection from the Rover (Client) to the Base (Access Point).
2. Establish a TCP connection between the ICOM port to be used for ALIGN corrections and the Access Point.
3. Configure the interface of the ICOM port to accept ALIGN corrections.

In the following examples, the ALIGN Rover is configured as a Wi-Fi Client connecting to the Base's Access Point. The Base's SSID is "PwrPak7-NMND17190003B", its password (passkey) is "12345678" and its IP address is the default 192.168.19.1. The SSID and password (passkey) information is printed on the label of the Base receiver or it can be obtained by requesting the **WIFIAPSETTINGS** log from the Base. The SSID is the receiver's PSN starting with the SM7-prefix.

#### DHCP configuration

In this example, the **WIFINETCONFIG** command is used to enable the Client to connect to the Base's Access Point using DHCP addressing. The **IPSTATUS** log is used to determine when an IP address has been assigned to the Wi-Fi client.



It can take several seconds for the IP parameters to be set.

```
wifinetconfig 1 enable "PwrPak7-NMND17190003B" "12345678" dhcp
wifimode client
icomconfig icom1 tcp 192.168.19.1:3001
interfacemode icom1 novatelx novatel off
log icom1 headingext2b onnew
hdtoutthreshold 1.0
```

```
log heading2a onnew
saveconfig
```

### Static IP address configuration

In this example, the **WIFINETCONFIG** command is used to enable the Client to connect to the Base's Access Point using a static IP address on the same subnet as the Base – 192.168.19.42 in this example. The Base's IP address (192.168.19.1 by default) is used as both the gateway and DNS server.

```
wifinetconfig 1 enable "PwrPak7-NMND17190003B" "12345678" static
192.168.19.42 255.255.255.0 192.168.19.1 192.168.19.1

wifimode client

icomconfig icom1 tcp 192.168.19.1:3001

interfacemode icom1 novatelx novatel off

log icom1 headingext2b onnew

hdtoutthreshold 1.0

log heading2a onnew
saveconfig
```

## Chapter 6 Ethernet configuration

---

This chapter describes how to configure the Ethernet port on an OEM7 receiver. It provides the step-by-step process for connecting to the OEM7 receiver through the Ethernet interface, setting up a base/rover configuration through Ethernet connectivity and utilizing the NTRIP interface. The Ethernet port connections for a computer connected to the receiver are also described for Windows 7 operating systems.



In this chapter, references to OEM7 receivers includes the SMART7-I and SMART7-SI.



The **SAVEETHERNETDATA** command can be issued to retain the Ethernet configuration settings after a **RESET/FRESET** command. The **ETHCONFIG** command and **IPCONFIG** command must be issued prior to using **SAVEETHERNETDATA** command. Refer to the [OEM7 Commands and Logs Reference Manual](#).

### 6.1 Required hardware

The following hardware is required to set up an Ethernet interface to an OEM7 receiver:

- a user supplied computer with an available Ethernet or serial
- a GNSS antenna
- an Ethernet capable OEM7 receiver
- an RS-232 null modem cable
- one or two CAT5 Ethernet cables
- a user supplied Ethernet network, hub or wired router (optional)
- a coaxial antenna cable (50  $\Omega$ )

### 6.2 Static IP address configuration

For a static IP address configuration, unique IP addresses are assigned to both the OEM7 receiver and the computer. TCP/IP is used for the connection in this simple network. This configuration can also be used in a bench test environment to confirm Ethernet functionality.

For connections when an OEM7 receiver uses a static IP address configuration, refer to *Figure 27: Cross-over Ethernet cable configuration—OEM7 receiver* on the next page.

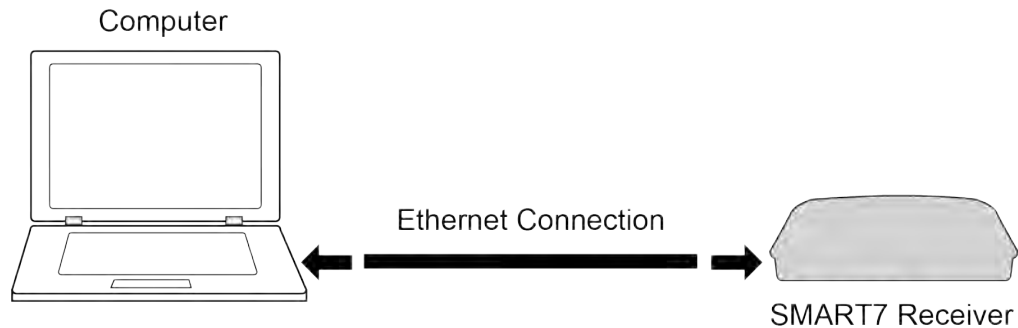
**Figure 27: Cross-over Ethernet cable configuration—OEM7 receiver**

### 6.2.1 Static IP address configuration—receiver

Follow these steps to set up a static IP address on the OEM7 receiver:

1. Connect a computer to the OEM7 receiver using a null modem serial cable.
2. Establish a connection to the receiver using either NovAtel Application Suite or another terminal program. This connection is used to send the commands in this procedure to the receiver.



For information about using NovAtel Application Suite, refer to [docs.novatel.com/Tools/Content/ToolsSuite/Overview.htm](https://docs.novatel.com/Tools/Content/ToolsSuite/Overview.htm).

3. Enable the Ethernet port on the receiver by entering:

```
ETHCONFIG ETHA AUTO AUTO AUTO AUTO
```

4. Assign the TCP/IP port number used for the connection by entering:

```
ICOMCONFIG ICOM1 TCP :2000
```

5. Assign the receiver IP address, subnet mask and default gateway by entering:

```
IPCONFIG ETHA STATIC 192.168.74.10 255.255.255.0 192.168.74.1
```



The command assigns the following values to the OEM7 receiver:

```
IP address = 192.168.74.10
Subnet mask = 255.255.255.0
Gateway = 192.168.74.1
```

These settings are examples only. The settings appropriate to your system may be different.

6. Save the new Ethernet settings by entering:

```
SAVEETHERNETDATA
```

7. Log the **IPCONFIG** command and confirm the TCP/IP configuration by entering:

```
LOG IPCONFIG ONCE
```

8. Configure your computer with a static IP address.  
Refer to *Static IP address configuration—Windows 7* below.

### 6.2.2 Static IP address configuration—Windows 7

Follow these steps to set up a static IP address on a computer:

1. Click **Start | Control Panel**.
2. Click **Network and Sharing Center**.
3. Click the **Local Area Connection** link.  
The Local Area Connection Status window appears.
4. Click the **Properties** button.  
The Local Area Connection Properties window appears.
5. Select **Internet Protocol Version 4 (TCP/IPv4)** and then click the **Properties** button.  
The Internet Protocol Version 4 (TCP/IPv4) Properties window appears.
6. Click the **Use the Following IP Address** radio button, then enter the IP address, Subnet mask and Default gateway for the Ethernet port on the computer.



Ensure the Ethernet settings used for the computer are compatible with the Ethernet settings on the OEM7 receiver.

For example, the following settings are compatible with the OEM7 receiver settings used in *Static IP address configuration—receiver* on the previous page:

```
IP address = 192.168.74.11  
Subnet mask = 255.255.255.0  
Gateway = 192.168.74.1
```

7. Click the **OK** button.  
The Local Area Connection Properties window appears.
8. Click the **Close** button.  
The Local Area Connection Status window appears.
9. Click the **Close** button.
10. Proceed to *Confirming Ethernet setup* below.

### 6.2.3 Confirming Ethernet setup

1. Connect the computer to the OEM7 receiver using an Ethernet cross-over cable.  
See *Figure 27: Cross-over Ethernet cable configuration—OEM7 receiver* on the previous page.
2. Connect to the receiver using NovAtel Application Suite or any third party terminal program that supports TCP/IP connections. Use the static IP address and port number assigned to the OEM7 receiver in *Static IP address configuration—receiver* on the previous page.

## 6.3 Dynamic IP address configuration

*Figure 28: Dynamic IP address configuration through a DHCP server—OEM7 receiver* on the next page shows the connections when an OEM7 receiver uses a dynamic IP address configuration.

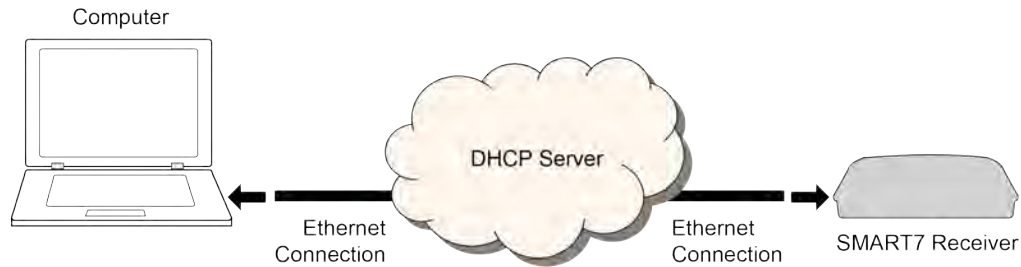
**Figure 28: Dynamic IP address configuration through a DHCP server—OEM7 receiver**

To set up a dynamic IP address configuration, follow these steps:

1. Connect a computer to the OEM7 receiver using a null modem serial cable or USB cable (model dependent).
2. Establish a connection to the receiver using either NovAtel Application Suite or another terminal program. This connection is used to send the commands in this procedure to the receiver.



For information about using NovAtel Application Suite, refer to [docs.novatel.com/Tools/Content/ToolsSuite/Overview.htm](https://docs.novatel.com/Tools/Content/ToolsSuite/Overview.htm).

3. Enable the Ethernet port by entering:

```
ETHCONFIG ETHA AUTO AUTO AUTO AUTO
```

4. Obtain the IP address assigned to the OEM7 receiver by the DHCP server.

```
LOG IPSTATUS ONCE
```



Make a note of the IP address returned with this log.

5. Assign the TCP/IP port number by entering:

```
ICOMCONFIG ICOM1 TCP :2000
```

6. Confirm the port number assigned to ICOM1 by entering:

```
LOG ICOMCONFIG ONCE
```

## 6.4 Base/rover configuration through Ethernet connectivity

You can use an Ethernet connection to provide communication between a base and rover receiver.

*Figure 29: Base/rover Ethernet setup—OEM7 receiver* on the next pageshows the connections when a base and rover OEM7 receiver are connected using Ethernet.

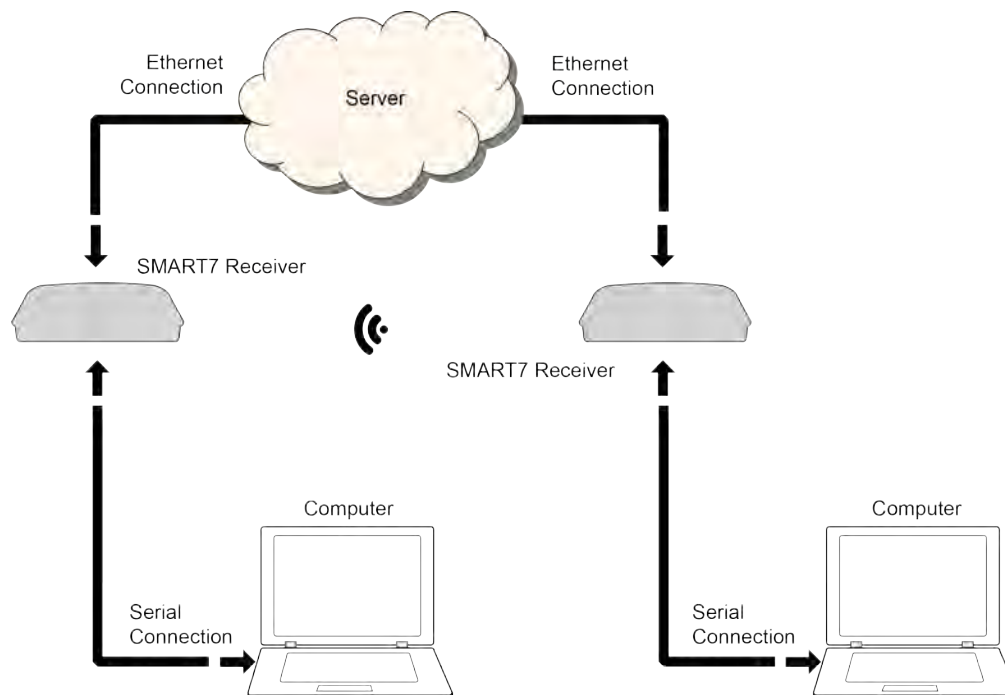
**Figure 29: Base/rover Ethernet setup—OEM7 receiver**

1. Connect your computer to both OEM7 receivers using null modem serial cables or USB cables.
2. Establish a connection to the receiver using either NovAtel Application Suite or another terminal program. This connection is used to send the commands in this procedure to the receivers.



For information about using NovAtel Application Suite, refer to [docs.novatel.com/Tools/Content/ToolsSuite/Overview.htm](https://docs.novatel.com/Tools/Content/ToolsSuite/Overview.htm).

3. Connect the power cables to both of the OEM7 receivers and apply power to the receivers.
4. Connect the Ethernet cables to the Ethernet ports on both OEM7 receivers.
5. Establish an Ethernet connection, either static or dynamic configurations. Refer to *Static IP address configuration* on page 102 or *Dynamic IP address configuration* on page 104 for more information.
6. Send the following commands to each receiver either through serial or USB ports:

**Base:**

```
FIX POSITION <lat> <long> <height>
INTERFACEMODE ICOM1 NONE RTCA off
LOG ICOM1 RTCAOBS2 ONTIME 1
LOG ICOM1 RTCAREF ONTIME 10
LOG ICOM1 RTCA1 ONTIME 5
SAVECONFIG
```

**Rover:**

```
ICOMCONFIG ICOM1 TCP <base ip address>:<base port #>
INTERFACEMODE ICOM1 RTCA NONE OFF
LOG BESTPOSA ONTIME 1 (optional)
SAVECONFIG
```

Use the **BESTPOS** log to confirm that the OEM7 rover is in RTK mode.

## 6.5 Large Ethernet port data throughput

For high data rate Ethernet logging using TCP/IP, disable Windows Delayed Ack Algorithm (DAA) for complete data logging. If you do not disable DAA, there will be data gaps due to the Windows Ethernet buffer.



**If done incorrectly, changing the Windows Registry may impair the operation of the computer. Editing the Windows Registry is for advanced Microsoft Windows users only. NovAtel Inc. is not able to provide any technical support for any actions taken regarding information found in Microsoft's Knowledge Base.**

## Chapter 7 NTRIP configuration

An Ethernet capable OEM7 receiver can be configured as either an NTRIP server or an NTRIP client. An OEM7 receiver using a Wi-Fi connection can be configured as an NTRIP client. For more information about NovAtel's NTRIP, refer to [novatel.com/products/firmware-options-pc-software/gnss-receiver-firmware-options/ntrip](http://novatel.com/products/firmware-options-pc-software/gnss-receiver-firmware-options/ntrip).

Figure 30: NTRIP system

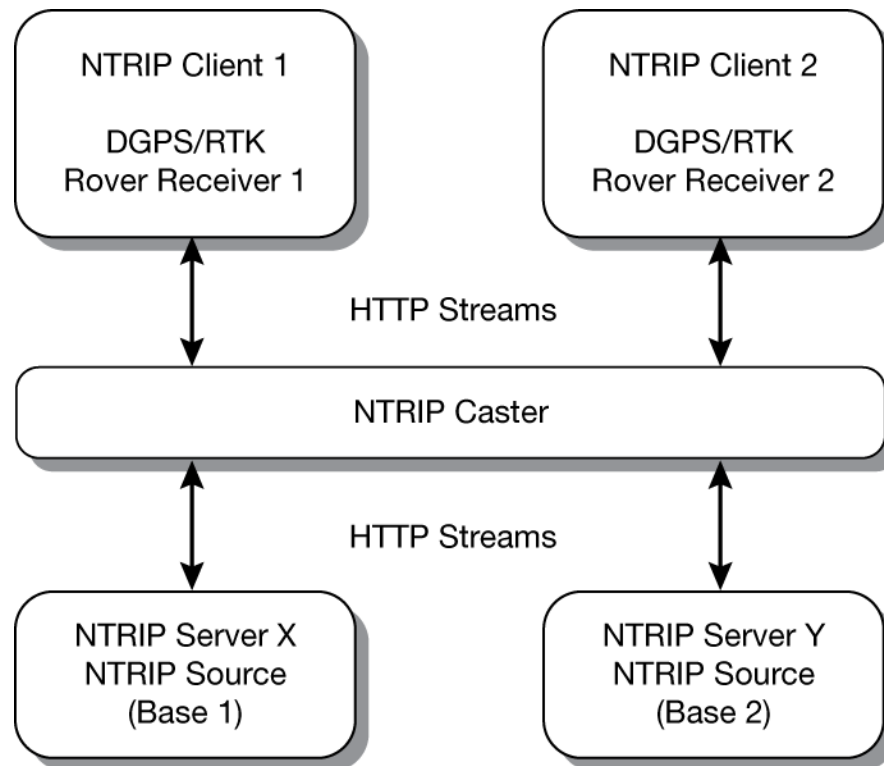

The NTRIP caster is an HTTP internet service that acts as a communication medium between NTRIP servers and NTRIP clients. The NTRIP caster is provided by third party sources. For a full list of NTRIP casters, refer to the following link: <http://www.rtcn-ntrip.org/home>.

### 7.1 NTRIP configuration over Ethernet

The following procedure describes how to configure a NovAtel base and a NovAtel rover through a third party NTRIP caster. This configuration is recommended for optimal RTK performance.

1. Establish a connection to the receiver using either NovAtel Application Suite or another terminal program. This connection is used to send the commands in this procedure to the receiver.



For information about using NovAtel Application Suite, refer to [docs.novatel.com/Tools](http://docs.novatel.com/Tools).

2. Connect the Ethernet cable to the Ethernet ports on both OEM7 receivers. For this setup, use a cross-over Ethernet cable.

- Establish a static or dynamic Ethernet connection.  
For information about creating the connection, refer to *Static IP address configuration* on page 102 or *Dynamic IP address configuration* on page 104.
- Use the following commands to enable the base receiver as an NTRIP Server:

```
NTRIPCONFIG NCOM1 SERVER V2 <endpoint> <mountpoint> <username>
<password> ETHA
INTERFACEMODE NCOM1 NONE RTCA OFF
FIX POSITION <lat> <long> <height>
LOG NCOM1 RTCAOBS2 ONTIME 1
LOG NCOM1 RTCAREF ONTIME 10
LOG NCOM1 RTCA1 ONTIME 1
SAVECONFIG
```

- Use the following commands to enable the rover receiver as an NTRIP Client:

```
ETHCONFIG ETHA AUTO AUTO AUTO AUTO
NTRIPCONFIG NCOM1 CLIENT V1 <endpoint> <mountpoint> <username>
<password > ETHA
```



If using a specific Network RTK system, certain National Marine Electronics Association (NMEA) strings are required to be sent from the rover back to the RTK network. For example, if connected to the VRS mount point, the rover is required to send its position to the network in a standard NMEA GGA message. This is achieved by issuing the following commands: **LOG NCOMx GPGGA ONTIME 5**, until data is received by the caster. For more information about Network RTK options and properties, refer to the application note [APN-041 Network RTK](#) and [APN-074: NTRIP on NovAtel OEM6/OEM7](#).

The following is an NTRIP Client configuration example without the use of a Network RTK system:

```
INTERFACEMODE NCOM1 RTCA NONE OFF
RTKSOURCE AUTO ANY
PSRDIFFSOURCE AUTO ANY
LOG BESTPOS ONTIME 1 (optional)
SAVECONFIG
```

## 7.2 NTRIP configuration over Wi-Fi

The following procedure describes how to configure a NovAtel rover through a third party NTRIP caster.

- Establish a connection to the receiver using either NovAtel Application Suite or another terminal program. This connection is used to send the commands in this procedure to the receiver.



For information about using NovAtel Application Suite, refer to [docs.novatel.com/Tools](https://docs.novatel.com/Tools).

- Log **WIFISTATUS** to monitor the Wi-Fi status on the receiver.

```
LOG WIFISTATUS ONCHANGED
```

- Set the Wi-Fi mode.

```
WIFIMODE CLIENT or WIFIMODE CONCURRENT
```

4. Check for available Wi-Fi access points.

```
LOG WIFINETLIST
```

5. Establish a connection with a Wi-Fi access point.

```
WIFINETCONFIG 1 ENABLE <access point name> <password>
```

6. Enable the receiver as an NTRIP client.

```
NTRIPCONFIG NCOM1 CLIENT V2 <endpoint> <mountpoint> <username>  
<password>
```



Refer to the **NTRIPCONFIG** command in the [OEM7 Commands and Logs Reference Manual](#) for further command details.

## Chapter 8 CAN bus

---

Controller Area Network (CAN) is a communication medium which allows for data exchange between devices using a multi-master serial data communication model. The main advantage of CAN is that multiple devices can communicate through two inexpensive wires that act as a BUS

The OEM7 receivers support the following CAN protocols:

- J1939 Transport and Extended Transport Protocol: used for corrections and NovAtel messages (both transmitting and receiving)
- NMEA2000: used for standard as well as NovAtel-proprietary messages (transmitting only)



CAN messages can also be read from or written to a CAN port using OEM7 commands and logs. This is typically implemented using the NovAtel API. For more information refer to Using Lua to Access I/O Devices Connected to the Receiver in the *OEM7 NovAtel API User Manual*. Note that if J1939 or NMEA protocol is enabled using the **CANCONFIG** command, the user CAN access commands will be rejected.

By default, CAN is disabled on OEM7 receivers. Critical CAN configuration parameters such as Parameter Group Numbers (PGNs), addresses and priorities are system-specific and must be explicitly configured.

The addresses and PGNs are typically allocated when the overall CAN bus topology is determined. A Node has a unique CAN J1939 NAME and address.



The SMART7 has internal CAN transceivers, however it still requires proper bus terminations.

Refer to *Table 28: SMART Antenna interface cable connector pinout* on page 162 for pin-out information.

OEM7 receivers support the following NMEA2000 Parameter Group Messages (PGN) over the CAN bus:

- PGN 126992 System Time
- PGN 127250 Vessel Heading
- PGN 127251 Rate of Turn
- PGN 129025 GNSS Position Rapid Update
- PGN 129026 COG & SOG Rapid Update
- PGN 129027 Position Delta High Precision Rapid Update
- PGN 129028 Altitude Delta, Rapid Update
- PGN 129029 GNSS Position
- PGN 129551 GNSS Differential Signal

OEM7 receivers also support the following J1939-71 Parameter Group Message (PGN) over the CAN bus: (OEM 7.08.15 firmware only. A SPAN hardware/software model is required.)

- PGN 65256 Vehicle Direction and Speed (requires a valid, converged SPAN solution)

The following commands and logs are used for CAN configuration:

- **CANCONFIG** command: controls the CAN transceiver hardware and places the receiver *on bus* or *off bus*
- **J1939CONFIG** command: assigns the CAN J1939 NAME and address parameters to a Node
- **J1939STATUS** log: reports the status a Node on the J1939 CAN network, such as the claimed address
- **LOG CCOMx PGNabcd**: configures the NMEA2000 messages
- **CCOMCONFIG** command: configures the parameters used by the NovAtel command interface to interact with the CAN Bus.



CCOM ports with a lower port number have a higher transmission priority.



For information about these commands, see the [OEM7 Commands and Logs Reference Manual](#).



When the *NMEASOLUTIONSOURCE* is set to *ANTENNA*, the Vessel Heading and Rate of Turn are sourced from *RTKHeadingSolutionDP*, resulting in a delay between the time the rover receives the data and when the time-synchronized PGN messages are published associated to the *ALIGN* functionality requirement. For example, when the PGNs are logged at 10 Hz the delay may be up to 100ms and vary depending on the *ALIGN* corrections update rate set. Conversely, when the *NMEASOLUTIONSOURCE* is set to *INS*, the Vessel Heading and Rate of Turn are sourced from *NMEAazimuthSolutionDP*, eliminating any significant delay between data provision and publication.



Details for the PGN messages can be found in the NMEA2000 specification which can be purchased directly from the National Marine Electronics Association ([www.nmea.org/](http://www.nmea.org/)).

## 8.1 Default configuration

After a FRESET, the receiver has the following CAN configuration:

- All CAN physical ports are disabled
- No J1939 addresses are claimed
- CCOM ports are configured for NMEA2000 messages only

**Table 15: Default NAME**

Parameter	Value
Address	0x1C
Industry Group	2
Device Class	0
Device Class Instance	0

Parameter	Value
Function	23
Function Instance	0
ECU Instance	0
Manufacturer Code	305

## 8.2 Configuring the CAN bus

To enable an OEM7 receiver to communicate over the CAN bus, configure CAN and place the receiver *on bus*, triggering a J1939 Address Claim Procedure.

1. Use the **J1939CONFIG** command to specify J1939 NAME and desired address.  
This step is optional and only required if the default NAME parameters are to be changed.
2. Use the **CANCONFIG** command to place the receiver *on bus*.
3. Optionally, use the **J1939STATUS** log to monitor CAN status on the receiver.

### 8.2.1 Configuration notes

- The **J1939CONFIG** and **CANCONFIG** commands can be entered in any order. After the **CANCONFIG** command is used to place the receiver on the CAN bus, **J1939CONFIG** commands take effect immediately. Until then, J1939CONFIG can be entered many times to change the settings because they have not taken affect yet (the receiver is not yet on the bus).
- The J1939 Address claim procedure is executed if and only if both J1939CONFIG NODEx CANx and CANCONFIG CANx ON are entered.
- Use J1939STATUS log to determine the receiver's CAN status and the actual address claimed by a particular node.
- Once the receiver is "on bus", it must be taken "off-bus" using CANCONFIG for any further configuration changes using J1939CONFIG.
- The receiver is fully "on-bus" only once the J1939 address has been successfully claimed. This is reported as "CLAIMED" status by J1939STATUS log.
- No messages will be sent or received until the receiver is "online" and an address is claimed. Outgoing messages are not buffered; they are discarded until the receiver is online.

### 8.2.2 Example of enabling the CAN bus

1. **LOG J1939STATUS ONCHANGED**
2. **J1939CONFIG NODE1 CAN1 <addresses>**
3. **CANCONFIG CAN1 ON 250K**
4. **SAVECONFIG**
  - < J1939STATUS NODE1 DISABLED 0 0xFE
  - < J1939STATUS NODE1 CLAIMING 1 <address>
  - < J1939STATUS NODE1 CLAIMED <attempt count> <address>

### 8.2.3 Example of modifying the CAN bus parameters

1. LOG J1939STATUS ONCHANGED
2. CANCONFIG CAN1 OFF
3. J1939CONFIG NODE1 CAN1 <addresses>
4. CANCONFIG CAN1 ON
5. SAVECONFIG
  - < J1939STATUS NODE1 DISABLED 0 0xFE
  - < J1939STATUS NODE1 CLAIMING 1 <address>
  - < J1939STATUS NODE1 CLAIMED <attempt count> <address>

### 8.2.4 Example of detecting an address claim failure and reconfiguring

1. LOG J1939STATUS ONCHANGED
2. J1939CONFIG NODE1 CAN1 <addresses>
3. CANCONFIG CAN1 ON
  - < J1939STATUS NODE1 DISABLED 0 0xFE
  - < J1939STATUS NODE1 CLAIMING 1 <address>
  - < J1939STATUS NODE1 FAILED <attempt count> 0xFE
4. CANCONFIG CAN1 OFF
  - < J1939STATUS NODE1 DISABLED 0 0xFE
5. J1939CONFIG NODE1 CAN1 <addresses>
6. CANCONFIG CAN1 ON
  - < J1939STATUS NODE1 CLAIMING 1 <address>
  - < J1939STATUS NODE1 CLAIMED <attempt count> <address>

### 8.2.5 Address claim procedure

To become operational on the CAN bus, an OEM7 receiver must claim a J1939 address. The preferred address and a range of alternative addresses are specified using the **J1939CONFIG** command. When a configured receiver is placed *on bus*, it may make multiple attempts to claim an address. It may also have its address bumped by a higher priority device claiming the same address.

While the device is attempting to claim an address, the **J1939STATUS** log reports a status of *CLAIMING* and automatically tries to claim the next allowed address. Depending on the **J1939CONFIG** parameters, an address different from the **J1939CONFIG** *preferred address* may be claimed or the address claim procedure can fail entirely. If no addresses could be claimed, a *FAILED* status is reported and the receiver takes no further action. To recover from this failure, take the receiver *off bus* using the **CANCONFIG** command and change the CAN address configuration using the **J1939CONFIG** command.

The address can also be assigned using J1939 *Commanded Address* message sent by another ECU on the bus, such as a tester unit. The commanded address always overrides the address specified using **J1939CONFIG** command. When the *Commanded Address* is received, the receiver reports a status of *CLAIMING* followed by *CLAIMED*. Restarting CAN using the **J1939CONFIG** command or **CANCONFIG** command clears the commanded address; the Address Claim procedure will be executed again based on parameters specified in the **J1939CONFIG** command.

## 8.3 NMEA2000 logging

OEM7 receivers support both a subset of the standard NMEA2000 PGNs, as well as NovAtel proprietary PGNs.

All NMEA2000 logs are configured using the **LOG** command, where the COM port is a CAN port (CCOM). The CCOM port must be associated with a J1939 node using the **CCOMCONFIG** command. If only NMEA2000 logs are needed, **CCOMCONFIG** parameters other than J1939NODE may be ignored.

To enable NMEA2000 logs:

1. Configure the CAN bus. See *Configuring the CAN bus* on page 113.
2. Enable the CCOM port on the CAN bus node using the **CCOMCONFIG** command.
3. Enable the desired NMEA2000 logs.

NMEA2000 logs can be requested regardless of the on/off bus status of the receiver or the J1939 configuration. They are output if and only if the receiver is online.



The position for the **PGN129025**, **PGN129027** and **PGN129029** logs are reported in the user selected datum. See the **OUTPUTDATUM** command for more details.



When the solution type is INS (SPAN models), the DOPs in the PGN129029 message are calculated at a 1 Hz rate.

To determine if the receiver is providing an INS solution, check the **pos type** field in the **BESTPOS** log.

### 8.3.1 Example of NMEA2000 log configuration

1. **CCOMCONFIG CCOM1 NODE1 NMEA2000**
2. **LOG CCOM1 PGN129025 ONTIME 0.5**
3. **LOG CCOM1 PGN129026 ONTIME 0.25**
4. **SAVECONFIG**

## 8.4 Corrections over CAN

All NovAtel supported correction types are supported over CAN ports (CCOM).

To send or receive corrections:

1. Configure the CAN Bus. See *Configuring the CAN bus* on page 113.
2. Use the **CCOMCONFIG** command to configure the PGN and other CAN parameters used by the RTK corrections CAN messages.

**PGN:** Use the PGN designated for corrections.

**Address:**

- Use 0xFF to receive corrections from any CAN address and to broadcast corrections to all CAN nodes.
- Use 0x00 to 0xFE to send corrections to or receive corrections from a specific CAN node.

3. Use the **INTERFACEMODE** command to configure the CCOM interface mode.

- To transmit corrections, use the desired INTERFACEMODE, e.g. RTCMV3
- To receive corrections, it is recommended to use INTERFACEMODE AUTO.



Corrections configuration (**CANCONFIG** and **INTERFACEMODE**) for a particular CCOM port do not affect its NMEA2000 configuration. NMEA2000 logs coexist with correction messages, both incoming and outgoing.

#### 8.4.1 Example for receiving corrections from any source

1. **CCOMCONFIG CCOM2 NODE1 J1939 61184 6 0xFF**
2. **INTERFACEMODE CCOM2 AUTO NONE OFF**

#### 8.4.2 Example for transmitting corrections to 0x1C node

1. **CCOMCONFIG CCOM2 NODE1 J1939 61184 6 0x1c**
2. **INTERFACEMODE CCOM2 NONE RTCMV3 OFF**

### 8.5 NovAtel messages over CAN

Standard NovAtel messages (commands, logs, responses) can be sent and received on the CAN Bus using CAN ports (CCOM). To reduce CAN Bus loading, NovAtel messages are sent using NovAtel standard binary format over J1939 (default).

The CCOM port requires special configuration and has the following limitations:

- A single CCOM port cannot be used for both Binary and ASCII / NovAtel ASCII messages.
- A single CCOM port cannot be used for both Binary messages and corrections.
- If the CCOM port is configured as *NOVATEL*, all input is interpreted as NovAtel ASCII or Abbreviated ASCII. Unlike other COM ports, the receiver will not distinguish between ASCII and binary input.
- To use CAN NOVATELBINARY, the CCOM port must be placed into NOVATELBINARY using the **INTERFACEMODE** command.



It is recommended to use one dedicated CCOM port for NovAtel messages and another dedicated CCOM port for corrections.



NovAtel UI configuration does not affect NMEA2000. Any CCOM port can be used for NMEA2000 logs irrespective of CCOMCONFIG settings.

To configure NovAtel User Interface over CAN:

1. Configure the CAN Bus. See *Configuring the CAN bus* on page 113.
2. Use the **CCOMCONFIG** command to configure the PGN and other CAN parameters.
3. Use the **INTERFACEMODE** command to configure the CCOM port for **NOVATELBINARY**.

Example: Configuring CCOM2 for NovAtel messages:

1. **CCOMCONFIG CCOM2 NODE1 J1939 1234 6 0x1C**
2. **INTERFACEMODE CCOM2 NOVATELBINARY NOVATELBINARY OFF**

## 8.6 Configuring OEM7 receivers to use OEM6 CAN settings

CAN Bus functionality has been enhanced on OEM7 receivers. To accommodate the enhancements in functionality and flexibility, several new commands and logs have been added. Also, the **SETCANNNAME** command has been removed and the **CANCONFIG** command has been modified.

The following sections describes how to configure CAN on OEM7 receivers to operate like OEM6 receivers.

### 8.6.1 Configuration on OEM6

On OEM6 receivers, the **SETCANNNAME** command, with minimal parameters, could be used to configure CAN.

```
SETCANNNAME 305
```

Once entered, a limited address claim procedure would take place and NMEA2000 logs would be generated automatically at a fixed logging rate and fixed CAN port bit rate.

### 8.6.2 Configuration on OEM7

To configure an OEM7 receiver to log the same commands and use the same logging rate and CAN port bit rate, enter the following commands:

```
CCOMCONFIG CCOM1 NODE1 NMEA2000
CANCONFIG CAN1 ON 250K
LOG CCOM1 PGN129025 ONTIME 0.1
LOG CCOM1 PGN129026 ONTIME 0.1
LOG CCOM1 PGN129027 ONTIME 0.1
LOG CCOM1 PGN129029 ONTIME 1.0
SAVECONFIG
```

On OEM7 receivers, nothing is automatically logged when CAN is enabled. Regular log requests must be made for each log required.

A full address claim procedure with default values is initiated with the **CANCONFIG ON** command. The **J1939CONFIG** command can be used to modify the default address claim parameters including the ManufacturingCode (set to 603 in the **SETCANNNAME** example above, now defaults to 305 in the new **J1939CONFIG**) but it's not necessary.

# Chapter 9 Built-In Status Tests

The Built-In Status Test monitors system performance and status to ensure the receiver is operating within specifications. The test detects an exceptional condition and informs the user through one or more indicators. The receiver status system is used to configure and monitor the indicators:

1. Receiver status word (included in the header of every message)
2. RXSTATUSEVENT log
3. RXSTATUS log

When a fatal event occurs (for example, a receiver hardware failure), a bit is set in the receiver error word, part of the **RXSTATUS** log, to indicate the cause of the problem. An **RXSTATUSEVENT** log is generated on all ports to show the cause of the error. Receiver tracking is disabled but command and log processing continues to allow error diagnosis. Even if the source of the error is corrected, the receiver must be reset to resume normal operation.

## 9.1 RXSTATUSEVENT log

The **RXSTATUSEVENT** log is used to output event messages, as indicated in the **RXSTATUS** log.

On start up, the OEM7 receiver is set to log **RXSTATUSEVENTA ONNEW** on all ports. You can remove this message using the **UNLOG** command.

Refer to the **RXSTATUSEVENT** log in the [OEM7 Commands and Logs Reference Manual](#) for log and command details for a more detailed description of this log.

## 9.2 RXSTATUS log

The Receiver Status log (RXSTATUS) provides system status and configuration information in a series of hexadecimal words.

### 9.2.1 Status word

The status word is the third field after the header, as shown in the example in *Figure 31: Location of receiver status word* below.

**Figure 31: Location of receiver status word**

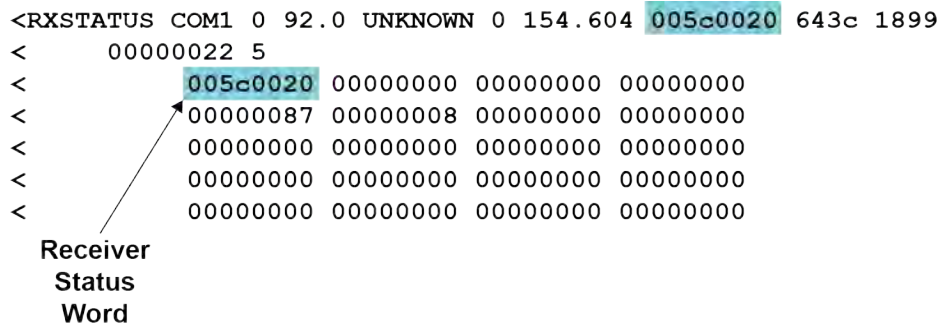

Each bit in the status word indicates the status of a specific receiver condition or function. If the status word is 00000000, the receiver is operating normally. The numbering of the bits is shown in *Figure 32: Reading the bits in the receiver status word* on the next page.

**Figure 32: Reading the bits in the receiver status word**

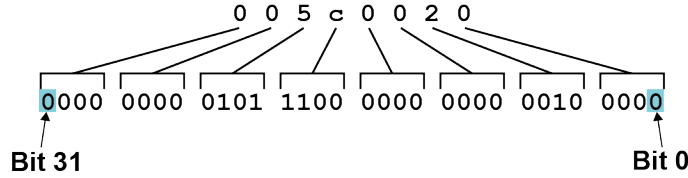

If the receiver status word indicates a problem, see *Examining the RXSTATUS log* on page 123.

### 9.2.2 Error word

The error field contains a 32-bit word. Each bit in the word is used to indicate an error condition. Error conditions may result in damage to the hardware or erroneous data, so the receiver is put into an error state. If any bit in the error word is set, the receiver broadcasts the **RXSTATUSEVENT** log on all ports (unless the user has unlogged it), idles all channels, turns the antenna off and disables the RF hardware. To override the error state, reset the receiver.

The receiver can be configured to generate event messages triggered by status conditions. Receiver Error words automatically generate event messages. These event messages are output in the **RXSTATUSEVENT** log (see also *Set and clear mask for all status code arrays* on the next page).

The error word is the first field after the log header in the **RXSTATUS** log, as shown in the example in *Figure 33: Location of receiver error word* below.

**Figure 33: Location of receiver error word**

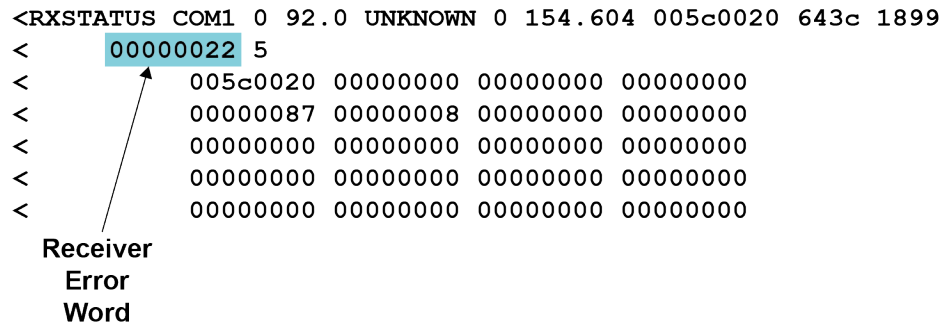

*Figure 34: Reading the bits in the receiver error word* below shows an example of a receiver error word.

**Figure 34: Reading the bits in the receiver error word**

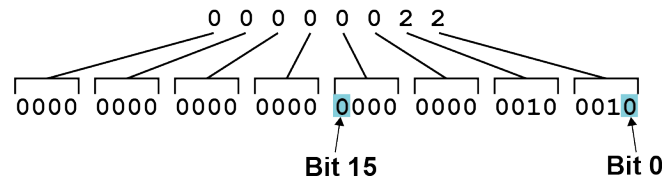

Refer to the **RXSTATUS** log and **RXSTATUSEVENT** log in the [OEM7 Commands and Logs Reference Manual](#) for more detailed log descriptions. If the receiver error word indicates an error, refer to *Examining the RXSTATUS log* on page 123.

### 9.2.3 Status code arrays

There are currently 5 status code arrays:

- receiver status word
- auxiliary 1 status
- auxiliary 2 status
- auxiliary 3 status
- auxiliary 4 status

Each status code array consists of four 32-bit words (the status word, a priority mask, a set mask and a clear mask). The status word is similar to the error word, with each of the 32 bits indicating a condition. The priority mask words are used to modify the behavior caused by a change in one of the bits in the associated status words. Each bit, in any mask, operates on the bit in the same position in the status word. For example, setting bit 3 in the priority mask changes the priority of bit 3 in the status word.

**Figure 35: Status code arrays**

```

<RXSTATUS COM1 0 92.0 UNKNOWN 0 154.604 005c0020 643c 1899
< 00000022 5
< 005c0020 00000000 00000000 00000000 ← Receiver Status
< 00000087 00000008 00000000 00000000 ← Auxiliary 1 Status
< 00000000 00000000 00000000 00000000 ← Auxiliary 2 Status
< 00000000 00000000 00000000 00000000 ← Auxiliary 3 Status
< 00000000 00000000 00000000 00000000 ← Auxiliary 4 Status

```

↑
↑
↑
↑

**Status Word**
**Priority Mask**
**Set Mask**
**Clear Mask**

### 9.2.4 Receiver status code

The receiver status word is included in the header of all logs. It has 32 bits that indicate certain receiver conditions. If any of these conditions occur, a bit in the status word is set. Unlike the error word bits, the receiver continues to operate, unless the priority mask for the bit has been set. The priority mask bit changes the bit in the receiver status word into an error bit. Anything that results from an error bit becoming active also occurs if a receiver status and its associated priority mask bits are set.

### 9.2.5 Auxiliary status codes

The auxiliary status codes are only in the **RXSTATUS** log. The four arrays that represent the auxiliary status codes indicate the receiver state for information purposes only. The events represented by these bits typically do not cause receiver performance degradation. The priority mask for the auxiliary codes does not put the receiver into an error state. Setting a bit in the auxiliary priority mask results in the corresponding bit in the receiver status code to be set if any masked auxiliary bit is set. Bit 31 of the receiver status word indicates the condition of all masked bits in the auxiliary 1 status word. Likewise, bit 30 of the receiver status word corresponds to the auxiliary 2 status word and bit 29 to the auxiliary 3 status word.

Refer also to the **RXSTATUS** log in the [OEM7 Commands and Logs Reference Manual](#) for a more detailed description.

### 9.2.6 Set and clear mask for all status code arrays

The other two mask words in the status code arrays operate on the associated status word in the same way. These mask words are used to configure the bits in the status word that result in a **RXSTATUSEVENT** log broadcast. The set mask is used to turn logging on temporarily while the bit changes from the 0 to 1 state. The clear mask is used to turn logging on temporarily while the bit changes from a 1 to a 0 state. Note the error

word does not have any associated mask words. Any bit set in the error word results in a **RXSTATUSEVENT** log broadcast (unless unlogged).

Refer also to the **RXSTATUS** log in the [OEM7 Commands and Logs Reference Manual](#) for a more detailed description.

## Chapter 10 Troubleshooting

There are simple ways to diagnose and resolve problems. In many cases, the issue can be resolved within a few minutes, avoiding the inconvenience and loss of productivity that results from having to return the receiver for repair. This section discusses troubleshooting issues and includes cross-references to other sections of the manual that may help resolve problems.

If unsure of the symptoms or if the symptoms do not match any of those listed, use the RXSTATUS log to check the receiver status and error words. See *Examining the RXSTATUS log* on the next page.

Try to resolve the problem using the troubleshooting guide in *Table 16: Troubleshooting based on symptoms* below, then try our Knowledge Base at [novatel.com/support](http://novatel.com/support). If you are still not able to resolve the problem, see *Customer Support* on page 17 for troubleshooting logs and contact information.

**Table 16: Troubleshooting based on symptoms**

Symptom	Related section
The receiver is not properly powered	Check the power cable. Replace if faulty. See <i>Power supply requirements for the SMART7</i> on page 32
The receiver cannot establish communication	Check the serial cables and ports. Replace if faulty. See <i>CAN bus</i> on page 111. Refer also to the <b>SERIALCONFIG</b> command.
The receiver is not tracking satellites	Ensure that the antenna has an unobstructed view of the sky from horizon to horizon.  Check the RXSTATUS error states. See <i>Examining the RXSTATUS log</i> on the next page. If the receiver is in error mode, it does not track.  Use the Interference Toolkit to check if there is an interference signal present. Go to the Interference Toolkit section in the NovAtel Documentation portal: <a href="http://docs.novatel.com/OEM7">docs.novatel.com/OEM7</a> .
No data is being logged	Refer to <i>CAN bus</i> on page 111 and <i>Communications with the receiver</i> on page 35
Random data is being output by the receiver or binary data is streaming	Check the baud rate on the receiver and in the communication software. Refer to the <b>SERIALCONFIG</b> command and <b>FRESET</b> command.  See also <i>CAN bus</i> on page 111.
A command is not accepted by the receiver	Check for correct spelling and command syntax. See <i>Communications with the receiver</i> on page 35 and refer to the <b>FRESET</b> command in the <a href="#">OEM7 Commands and Logs Reference Manual</a>
Differential mode is not working properly	See <i>Transmitting and receiving corrections</i> on page 39 and refer to the <b>SERIALCONFIG</b> command.

Symptom	Related section
There appears to be a problem with the receiver's memory	Refer to the <b>NVMRESTORE</b> command.
An environmental or memory failure. The receiver temperature is out of acceptable range or the internal thermometer is not working	Move the receiver to within an acceptable temperature range. See: <ul style="list-style-type: none"> <li>• <i>High temperature environments</i> on page 128</li> <li>• <i>SMART7 environmental and electrical specifications</i> on page 158</li> </ul>
Overload and overrun problems. Either the CPU or port buffers are overloaded	Reduce the amount of logging or increase the baud rate.
The receiver is indicating that an invalid authorization code has been used	Refer to the <b>VERSION</b> log or <b>VALIDMODELS</b> log and the <b>MODEL</b> command or <b>AUTH</b> command.
The receiver is being affected by jamming	Move the receiver away from any possible jamming sources
The receiver is being affected by interference	Go to the Interference Toolkit section in the NovAtel Documentation portal: <a href="https://docs.novatel.com/OEM7">docs.novatel.com/OEM7</a> . Move the GNSS antenna away from the source of the interference signal. If the interference mitigation feature is enabled on the receiver, configure a filter within the Interference Toolkit to filter out the interference signal.
The receiver's Automatic Gain Control (AGC) is not working properly	See the jamming symptom in this table

For information about the commands and logs in this section, refer to the [OEM7 Commands and Logs Reference Manual](#).

## 10.1 Examining the RXSTATUS log

The RXSTATUS log provides detailed status information about your receiver and can be used to diagnose problems. Refer to the **RXSTATUS** log for details on this log and on how to read the receiver error word and status word. *Table 17: Resolving a receiver error word* below, *Table 18: Resolving an error in the receiver status word* on the next page and *Table 19: Resolving an error in the AUX1 status word* on page 126 have actions to take when your receiver has an error flag in these words. If you are not able to resolve the condition, contact *Customer Support* on page 17.

**Table 17: Resolving a receiver error word**

Bit set	Action to resolve
0-2	Issue a <b>FRESET</b> command (for bit 1, reload new firmware).
4	Contact <i>Customer Support</i> on page 17.
5	Check the <b>VERSION</b> log. The VERSION log will indicate "Invalid authcode". Upgrade the auth-code as described in <i>Upgrading using an Auth-Code</i> on page 149.

Bit set	Action to resolve
6	Issue a <b>FRESET</b> command
7	See <i>Power supply requirements for the SMART7</i> on page 32
8	Reserved
9	<p>Check the temperature ranges in:</p> <ul style="list-style-type: none"> <li><i>SMART7 environmental and electrical specifications</i> on page 158</li> </ul> <div style="border: 1px solid #0070C0; padding: 10px; margin-top: 10px;">  The operating temperatures are ambient air temperatures. The temperature sensors on the receiver PCB will reflect higher operating temperatures (refer to the <b>HWMONITOR</b> log). The PCB temperature sensors will trigger a receiver warning and receiver error at 100°C and 110°C respectively. The warning and error conditions are captured using the <b>RXSTATUS</b> log. </div>
10	Possible hardware or environmental condition. If you cannot resolve the problem, contact <i>Customer Support</i> on page 17.
11	<p>Possible hardware or environmental condition. If you cannot resolve the problem, contact <i>Customer Support</i> on page 17.</p> <p>Also, check the Auxiliary 2 Status word to determine which PLL is in error.</p>
12-14	Reserved
15	Issue a <b>FRESET</b> command and power cycle the unit. If the bit is still present, contact <i>Customer Support</i> on page 17.
16	Monitor CPU idle time. Reduce number of logs or the rate of data logging.
17	Ensure that the Version log is consistent with the hardware.
18-19	Reserved
20	SoftLoad is in progress. See <i>Updating using SoftLoad commands</i> on page 136.
21	You may be exceeding the receiver's velocity limit. If so, reduce velocity. This error can only be cleared by resetting the receiver.
22	Reload firmware using NovAtel Application Suite or the SoftLoad commands.
23-30	Reserved
31	Possible hardware failure. Contact <i>Customer Support</i> on page 17.

**Table 18: Resolving an error in the receiver status word**

Bit set	Action to resolve
0	Check the Error Word in the <b>RXSTATUS</b> log. See also <i>Table 17: Resolving a receiver error word</i> on the previous page

Bit set	Action to resolve
1	Check the temperature ranges in <ul style="list-style-type: none"> <li>• <i>SMART7 environmental and electrical specifications</i> on page 158</li> </ul>
2	See <i>Power supply requirements for the SMART7</i> on page 32
3	For SMART Antennas, contact <i>Customer Support</i> on page 17
4	
5	
6	
7	Check the CPU idle time. Check for unnecessary logging. Check for simultaneous use of functionality.
8	See <i>Table 9: Serial ports supported</i> on page 36 Also, check the Auxiliary 2 Status word to determine which COM port has overrun its buffer.
9-11	Reserved
15	Check the Auxiliary 1 status word to determine which RF channels are jammed.
16-17	Reserved
18	When the receiver has tracked GNSS satellites long enough for a valid almanac to be received, this bit will be set to 0.
19	None. This bit only indicates if the receiver has calculated a position.
20	None. This bit is a status bit indicating if the receiver's position has been manually fixed and does not represent a problem. Refer also to the <b>FIX</b> command.
21	None. This bit indicates if clock steering has been manually disabled. Refer also to the <b>FRESET</b> command.
22	None. This bit only indicates if the clock model is valid. Refer also to the <b>FRESET</b> command.
23	None. This bit indicates if the phase-lock-loop is locked when using an external oscillator. Refer also to the <b>FRESET</b> command.
24	Check the CPU idle time. Check for unnecessary logging. Check for simultaneous use of functionality.
25-26	None. These bits identify the receiver family. For OEM7 receivers, bit 25 is set to 1 and bit 26 is set to zero.
27	Interference Toolkit HDR mode status. When this bit is set to 1, Interference Toolkit HDR mode is enabled.
28	Digital filter status. When this bit is set to 1, an Interference Toolkit digital filter is enabled.
29	None. This bit indicates if any bits in the auxiliary 3 status word are set. The auxiliary 3 word provides status information and does not contain any new information on problems. Refer also to the <b>FRESET</b> command.

Bit set	Action to resolve
30	None. This bit indicates if any bits in the auxiliary 2 status word are set. The auxiliary 2 word provides status information and does not contain any new information on problems. Refer also to the <b>FRESET</b> command.
31	None. This bit indicates if any bits in the auxiliary 1 status word are set. The auxiliary 1 word provides status information and does not contain any new information on problems. Refer also to the <b>FRESET</b> command.

For information about the commands and logs in this section, refer to the [OEM7 Commands and Logs Reference Manual](#).

## 10.2 Examining the AUX1 status word

Table 19: Resolving an error in the AUX1 status word below provides actions to take when your receiver has an error flag in the AUX1 status word.

**Table 19: Resolving an error in the AUX1 status word**

Bit set	Action to resolve
0-2	Jammer detected
3	None. This bit indicates that Position Averaging is ON
4-6	Jammer detected
7	(Reserved bit)
8-10	(Reserved bits)
11	(Reserved bit)
12	None. This bit indicates a Profile set using the <b>PROFILE</b> command is activated.
13	Throttled Ethernet Reception Check for unusually high Ethernet traffic being directed to the Receiver. This does not represent an error condition on the receiver, but suggests there may be an issue in the network environment on the receiver.
14-17	AGC error on RF1 through RF4 respectively.. Contact NovAtel <i>Customer Support</i> on page 17 for additional information.
18	Connect the receiver via Ethernet. See <i>Ethernet port</i> on page 30
19-21	Reduce the amount of logging on the Ethernet ports
22-24	Reduce the amount of logging on the NTRIP ports
25-27	Reduce the amount of logging on the Virtual COM ports
28-29	AGC error on RF5 (bit 28) or RF6 (bit 29).. Contact NovAtel <i>Customer Support</i> on page 17 for additional information.
30-31	(Reserved bits)

**Table 20: RF paths for OEM7 receivers**

RF path	OEM719, OEM729, OEM7700, PwrPak7, CPT7700, SMART7	OEM7720, PwrPak7D, CPT7	OEM7500, OEM7600, SMART2
RF1	GPS L1 GLONASS L1 Galileo E1 BDS B1 QZSS L1 SBAS L1	1st antenna GPS L1 GLONASS L1 Galileo E1 BDS B1 QZSS L1 SBAS L1	GPS L1 GLONASS L1 Galileo E1 BDS B1 QZSS L1 SBAS L1
RF2	Reserved	Reserved	GPS L2/L5 GLONASS L2/L3 Galileo E5 BDS B2 QZSS L2/L5 NavIC L5 SBAS L5
RF3	GPS L2 GLONASS L2 Galileo E6 BDS B3 QZSS L2/L6	1st antenna GPS L2/L5 GLONASS L2/L3 Galileo E5 BDS B2 QZSS L2/L5 NavIC L5 SBAS L5	Reserved
RF4	GPS L5 GLONASS L3 Galileo E5 BDS B2 QZSS L5 NavIC L5 SBAS L5	2nd antenna GPS L1 GLONASS L1 Galileo E1 BDS B1 QZSS L1	Reserved
RF5	Reserved	2nd antenna GPS L2/L5 GLONASS L2/L3 Galileo E5 BDS B2 QZSS L2/L5 NavIC L5	Reserved
RF6	Reserved	Reserved	Reserved

## 10.3 High temperature environments

The operating temperature of OEM7 receivers increases as more features (channels used, HDR mode, etc.) are enabled.

When the receiver is operating in an environment that is near its maximum ambient temperature, an increase in the ambient air temperature or enabling additional features may cause the receiver to exceed its maximum operating temperature and generate a Temperature Status error. When a Temperature Status error occurs, the receiver idles all channels, turns off the antenna and disables the RF hardware. The communication interfaces continue to function so commands can be sent and logs received.

### 10.3.1 Indicators of an error state

The indications that the receiver is in an error state, such as a Temperature Status error, are:

- Logs that have a solution status will show `INSUFFICIENT_OBS` as the Solution Status.
- The **RXSTATUSEVENT** log is output on all communication ports. This log will indicate an error condition in the Receiver Error word of the log.
- All logs output have Bit 0 set in the Receiver Status word of the log header.

To determine the cause of the error, log the **RXSTATUS** log and check the Receiver Error word. If Bit 9 is set, it is a Temperature Status error. For information about reading the Error Word, refer to *Error word* on page 119.

### 10.3.2 Recovering from a temperature status error

The receiver must be reset or power cycled to recover from a receiver error such as a Temperature Status error.

Log information is lost when the receiver is reset. Therefore, any logs required to identify and troubleshoot the error, such as the **RXSTATUS** log, should be collected before resetting the receiver.

Also, steps should be taken to reduce the cause of the receiver temperature error to prevent the error from occurring again. See *Mitigating high receiver temperature* below.

### 10.3.3 Mitigating high receiver temperature

If the receiver has a high temperature warning or error, use one or more of the following suggestions to reduce the receiver temperature.

- If possible, reduce the ambient temperature around the receiver or move the receiver to an area with a lower ambient temperature.
- Disable the receiver features that are not required for the current operation of the receiver.

### 10.3.4 Monitoring the receiver temperature

If the receiver is operating in a high ambient temperature environment, you can monitor the receiver temperature using the **RXSTATUS** and **HWMONITOR** logs.

1. Log the **RXSTATUS** log and check Bit 1 of the Receiver Status word.

```
LOG RXSTATUS onchanged
<RXSTATUS USB1 0 81.5 FINESTEERING 1990 326146.020 0a104020 2ae1 14434
< 00000000 5
< 0a104020 00000000 00030000 00030000 (Receiver Status)
< 00062000 00001008 00000000 00000000
< 00000000 00000000 80000000 00000000
< 80000000 00000000 00000000 00000000
```

```
< 00000000 00000000 00000000 00000000
```

For information about reading the Receiver Status word, refer to *Status word* on page 118.

2. If Bit 1 is 0, the temperature is okay. Continue monitoring, but no action is required.  
If Bit 1 is 1, the receiver temperature has exceeded the warning limit.
3. Log the **HWMONITOR** log and check the two temperature status fields (0x01 and 0x16).

```
LOG HWMONITOR ontime 30
<HWMONITOR USB1 0 77.5 FINESTEERING 1990 326851.000 0a104020 52db
14434
< 10
< 58.424915314 100 (Temperature 0x01)
< 0.000122100 200
< 3.296703339 600
< 5.169230938 700
< 1.192307711 800
< 3.300366402 f00
< 1.833943844 1100
< 5.159462929 1500
< 1.555555582 1700
< 58.485961914 1600 (Temperature 0x16)
```

Pay attention to the reading and the boundary limit status.

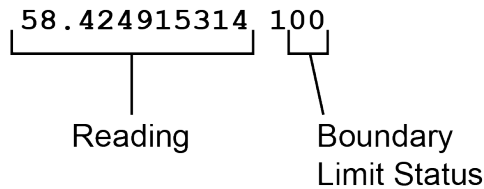

Refer to Table: HWMONITOR Status Table in the **HWMONITOR** log section for a description of the Boundary Limit Status.

4. Use the suggestions in *Mitigating high receiver temperature* on the previous page to reduce the receiver temperature.
5. Continue monitoring the **HWMONITOR** log to see if receiver temperature is dropping.
6. Check the **RXSTATUS** log to see if the temperature status changes to Okay (Bit 1 in the Receiver Status word changes to 0).

## 10.4 Safe Mode

Safe Mode is an error condition triggered on the OEM7 receiver if it encounters certain critical problems during start-up. The receiver does not track GNSS satellites in this state, but the user interface is still available to allow for diagnosis of the problem.

The receiver will enter Safe Mode under certain rare cases including the following:

- Corrupted or bad data within the receiver Non-Volatile Memory (NVM).
- An unsupported Auth Code.
- The expected main firmware image could not be found by the boot code. This is possibly due to an error during the main firmware loading process (i.e. NovAtel Application Suite, SoftLoad, etc.).

Safe Mode exists to allow users to take steps to recover the receiver after such an error occurs. Potential recovery steps are described in *Recovery steps* on the next page.

Safe Mode is indicated by an error bit in the **RXSTATUS** log.

### 10.4.1 *Reset loop detection*

In order to determine when the Safe Mode error should be triggered, OEM7 receivers have the ability to detect when an unexpected reset has occurred during the boot process. If a Reset Loop is detected, the **Reset Loop Detected** bit is set in the **RXSTATUS** log.

This bit is only a warning and the receiver may still be able to operate correctly. The receiver will allow several unexpected resets to occur before triggering the Safe Mode Error, at which point the receiver will not track GNSS satellites.

### 10.4.2 *Recovery steps*

If the **Safe Mode** error bit or the **Reset Loop Detected** warning bit are set in the **RXSTATUS** log, take the following steps to diagnose and recover the system:

1. Request the **SAFEMODESTATUS** log and determine the current *Safe Mode State* of the system.
2. Reference Table: Safe Mode States in the [OEM7 Commands and Logs Reference Manual](#) and find the suggested actions for the current Safe Mode State.
3. If the suggested actions do not resolve the issue, contact NovAtel Customer Support.

# Chapter 11 NovAtel firmware

---

Download the most recent versions of the NovAtel firmware from the [novatel.com/support/support-materials/firmware-download](https://novatel.com/support/support-materials/firmware-download).

NovAtel firmware runs on NovAtel receivers. It provides the features and functionality available on the receiver.

## 11.1 Firmware updates and model upgrades

A local NovAtel dealer can provide all the information needed to upgrade or update a receiver. Refer to [novatel.com/contactus/sales-offices](https://novatel.com/contactus/sales-offices) for contact information or contact [sales.nov.ap@hexagon.com](mailto:sales.nov.ap@hexagon.com) or [support.novatel@hexagon.com](mailto:support.novatel@hexagon.com) directly.

### 11.1.1 Firmware updates

Firmware updates are firmware releases that include fixes and enhancements to the receiver functionality. Firmware updates are released on the NovAtel web site as they become available. Firmware upgrades can be performed using NovAtel Application Suite, Manage Web, SoftLoad commands or a custom loader application. Contact NovAtel Customer Support ([support.novatel@hexagon.com](mailto:support.novatel@hexagon.com)) for details on custom loader requirements.

### 11.1.2 Model upgrades

Model upgrades enable purchased receiver features.

Contact a local NovAtel dealer to assist in selecting the upgrade options that best suit your GNSS needs at [novatel.com/contactus/dealer-network](https://novatel.com/contactus/dealer-network). Contact NovAtel Customer Support [novatel.com/support](https://novatel.com/support) or [novatel.com/contactus/sales-offices](https://novatel.com/contactus/sales-offices) to request a temporary upgrade authorization code for trial purposes.

Model upgrades can be applied to the receiver with an authorization code and the **AUTH** command without returning the receiver to the dealer.

### 11.1.3 Firmware downgrades

Receiver firmware can be rolled back to a previous version by downloading the previous firmware version onto the receiver. However before downgrading the firmware, perform a factory reset of the receiver using the **FRESET** command to ensure all saved commands have been erased.



**A factory reset using the FRESET command is required before downgrading firmware. Not performing a factory reset could cause unpredictable behavior.**

## 11.2 Authorization code

An authorization code, commonly known as an auth-code, is required to change the software model on a receiver. Auth-codes are obtained by contacting [novatel.com/support](https://novatel.com/support). Upon contact, NovAtel Customer Support requires:

- the receiver model number
- the receiver serial number
- the receiver firmware version

Enter the **LOG VERSION** command to determine the receiver model, serial number and firmware version.

Example:

	Model Number	Serial Number		Firmware Version
GPSCARD	"CFNPNNTVN"	"BMGX15360001Z"	"OEM729-0.00H"	"OM7MR0000RN0000"
				<div style="display: flex; justify-content: space-around; width: 100%;"> <div style="border: 1px solid black; width: 30px; height: 15px; margin: 0 auto;"></div> <div style="border: 1px solid black; width: 30px; height: 15px; margin: 0 auto;"></div> <div style="border: 1px solid black; width: 30px; height: 15px; margin: 0 auto;"></div> </div>
				Product Family      Firmware Number      Release Indicator

After determining the appropriate model and firmware version, the authorization code (auth-code) is issued. The auth-code is required to unlock the features on the new model type.

To upgrade to a new model with the same firmware version, use the **AUTH** command with the issued auth-code, as outlined in *Upgrading using an Auth-Code* on page 149.

To upgrade to a new model with a new firmware version, the new firmware needs to be loaded into the OEM7 receiver. For instructions, refer to *Updating the firmware using NovAtel Application Suite* on page 135, *Updating the firmware using Manage Web* on page 136 or *Updating using SoftLoad commands* on page 136.

Auth-codes work with any signed firmware image. Therefore, if a receiver has an auth-code for the old version of firmware, that same auth-code will work for the new version of firmware, provided both images are digitally signed by NovAtel.

Signed firmware images are distributed in \*.shex files. The new download package includes a signed firmware file type that uses an extension designated as ".shex" (example OM7MR0902RN0000.shex), as well as the What's New file containing firmware update change details.

Temporary auth-codes may be provided by NovAtel for evaluation purposes. Once the trial period has expired, the functionality provided by the auth-code is removed. The expiration date for temporary auth-codes is in the form YYMMDD, where YY = year, MM = month and DD =day. The date is the last day that the auth-code is valid and expires at the end of day, UTC time.

Once the trial period has expired, a new auth-code will need to be obtained from NovAtel Customer Support ([support.novatel@hexagon.com](mailto:support.novatel@hexagon.com)).

Firmware images may also have auth-codes embedded within them. The models provided by such firmware images will be valid only on receivers with certain PSNs and Hardware Versions.

## 11.3 Downloading firmware files

To proceed with an update or possibly an upgrade, obtain the latest version of firmware by downloading the firmware file for your product from [novatel.com/support/support-materials/firmware-download](http://novatel.com/support/support-materials/firmware-download).

### 11.3.1 Format of firmware files

All of the firmware available on the downloads website are packaged in .zip files with the following name:

- <receiver type>\_Firmware\_7.xx.xx.zip

For convenience, unzip the update file to a GNSS sub-directory (for example, C:\GNSS\LOADER). If the firmware update file is password protected, NovAtel Customer Support provides the required password.

The zip archive includes the following files:

x..x.shex	Firmware version upgrade file, where x..x defines the product name and release (e.g., OM7MR09023RN0000.shex)
-----------	--

HowTo_7XXXX_YYY.pdf	Instructions on how to install the firmware 7XXXX identifies the firmware version and YYY identifies the type of receiver
NovAtel Software License Agreement.pdf	License agreement for the firmware
WhatsNew_7XXXX.pdf	Information on the changes made in the firmware since the last revision 7XXXX identifies the firmware version



NovAtel has an online video tutorial that explains firmware updating at: [novatel.com/support/support-materials/novatel-video](http://novatel.com/support/support-materials/novatel-video).

## 11.4 Updating or upgrading using the WinLoad utility



The WinLoad utility is no longer provided with new firmware releases.

NovAtel recommends using NovAtel Application Suite or Manage Web to load new firmware onto the receiver.

WinLoad is a utility used to update or upgrade a receiver. To use WinLoad, the receiver must be connected to the computer running WinLoad using a serial port (COM port) connection.

If opening WinLoad for the first time, ensure the file and communications settings are correct.

### 11.4.1 Open a file to download

Select File | File Open. Navigate to the file to open (*Figure 36: WinLoad's Open Window* below).

**Figure 36: WinLoad's Open Window**

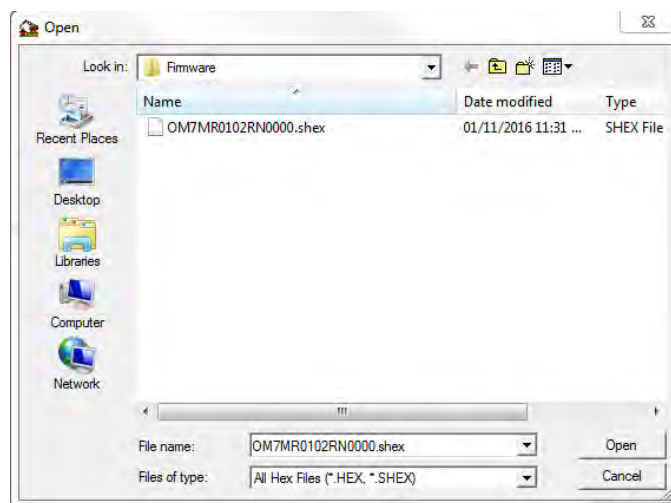

When a file is selected, the *filename* appears in the main WinLoad display area and in the title bar (*Figure 37: Open File in WinLoad* on the next page).

Figure 37: Open File in WinLoad

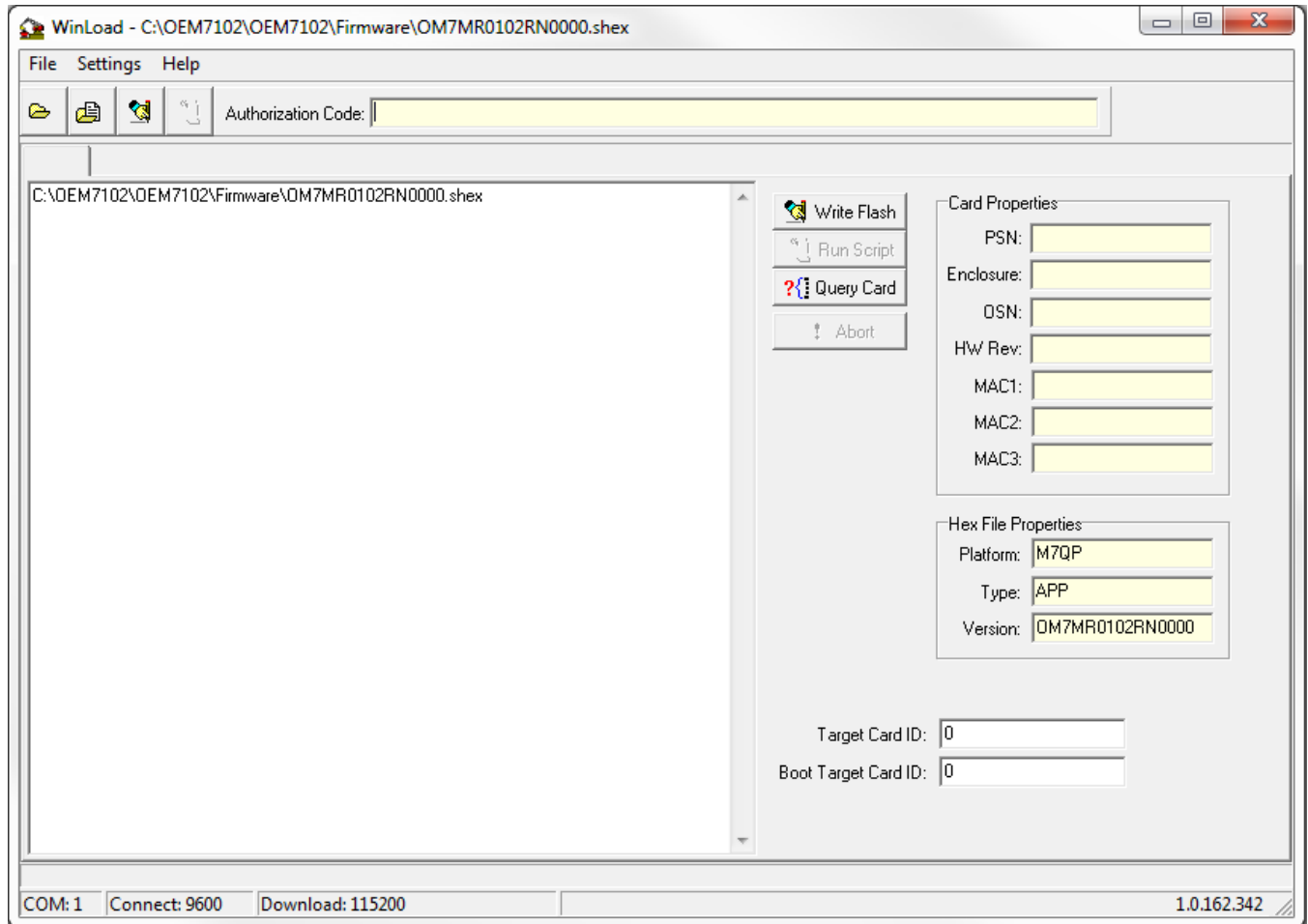

### 11.4.2 Communications settings

To set the communications port and baud rate, select Settings | COM Settings. Choose the computer port to use from the Com Port drop down list and the baud rate from the Download Baudrate drop down list. Set the baud rate as high as possible (the default of 115200 is preferred if a higher baud rate is not available).

Figure 38: COM Port Setup

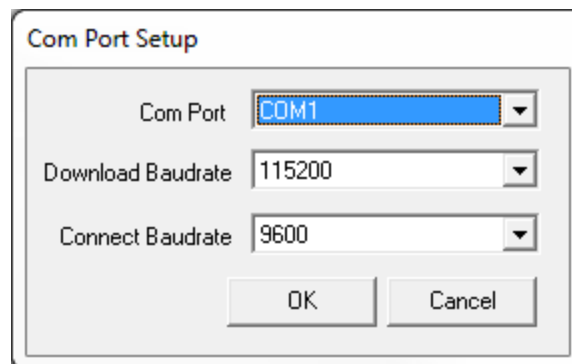

### 11.4.3 Downloading firmware

1. Select the file to download according to *Open a file to download* on page 133.
2. Ensure the file path and name are displayed in main display area (see *Figure 37: Open File in WinLoad* on the previous page).
3. Click **Write Flash** to download the firmware.
4. When **Searching for card** appears in the main display, power cycle the receiver.
5. If the Authorization Code window appears, enter the auth-code and click **OK**. See *Authorization code* on page 131 for further information about the Authorization Code.
6. The receiver finishes the download and then resets. The process is complete when **Done** appears in the main display area.
7. Close WinLoad.



If loading a firmware that is currently installed on a receiver (i.e. reloading the same version of firmware on a receiver), ensure the *Optimized Loading* option is unchecked in WinLoad under *Settings | Options | Optimized Loading*.

As well, if firmware loading fails with the error message "Desired SW already is on board", ensure the *Optimized Loading* option is unchecked.

## 11.5 Updating the firmware using NovAtel Application Suite

To use NovAtel Application Suite to update the receiver firmware, the receiver must be connected to the computer running NovAtel Application Suite using a serial (COM) port, USB port or Ethernet port.

To update the firmware on the receiver:

1. Obtain the new firmware file.

See *Downloading firmware files* on page 132 for information about obtaining the latest version of receiver firmware.



Copy the firmware file to the computer's local drive before uploading.

2. Connect a computer to the receiver using a serial (COM) cable, USB cable or Ethernet connection.
3. Start NovAtel Application Suite on the computer.
4. Use NovAtel Application Suite to connect to the receiver.  
For information about using NovAtel Application Suite, refer to [docs.novatel.com/Tools/Content/ToolsSuite/Overview.htm](https://docs.novatel.com/Tools/Content/ToolsSuite/Overview.htm).
5. On the *Status and Configuration* window, click the **Device** menu and select **Update**.  
The *Update* window appears.
6. Click the **Browse** button.
7. Navigate to the directory that contains the new firmware file and select the file.
8. Click the **Open** button.

The Update window appears with the name of the selected file in the Select File field.

9. Click the **Apply** button.

After the new software is loaded, the receiver will restart.

## 11.6 Updating the firmware using Manage Web

To use NovAtel Manage Web to update the receiver firmware, the receiver must be connected to the receiver using an Ethernet or Wi-Fi connection.

To update the firmware on the receiver:

1. Obtain the new firmware file.

See *Downloading firmware files* on page 132 for information about obtaining the latest version of receiver firmware.



Copy the firmware file to the device's local drive before uploading.

2. Use a Wi-Fi capable device (such as a laptop, tablet or smart phone) to connect to the receiver's Wi-Fi access point. The SSID and password for the receiver Wi-Fi are on a label on the receiver.

Alternately, connect the receiver to a computer using an Ethernet connection.

3. Open a web browser and enter **192.168.19.1** in the address (URL) bar of the browser. If using an Ethernet connection, enter the IP address assigned to the receiver.

The Manage Web Home page appears.

4. Click the Menu icon and select **Update**.
5. Click the **Select File** button
6. Navigate to the folder in which the new software to load is stored and select the software file.
7. Click the **Apply** button.

After the new software is loaded, the receiver will restart.

## 11.7 Updating using SoftLoad commands

Firmware can be updated on a running receiver using a process called SoftLoad. Any available communication ports on the receiver (COM, USB, ICOM) can be used. The SoftLoad process is made up of a set of commands and logs that are used to send new firmware data to a receiver and check the progress of the update.

Use SoftLoad if automated loading is desired or if the receiver does not have access to tools such as NovAtel Application Suite or Manage Web, to load firmware.

The receiver stops tracking GNSS satellites during the SoftLoad process. Do not attempt to SoftLoad when GNSS satellite tracking on the unit is required.

### 11.7.1 Implementing SoftLoad

To implement the SoftLoad process, you can either:

- Use SoftLoad Customer Support utilities:

You can use NovAtel developed utilities to upgrade firmware. This method is easier to implement than self-implementing Softload. For more information suitability and implementation, refer to *Use SoftLoad Customer Support utilities* below.

- Self-Implement the SoftLoad process:

You can develop the process on your own, including processing the S-Records, converting them to NovAtel format commands, and Sending Firmware Data. This method is suitable for users with deeply embedded receivers and is more difficult to implement and integrate. For more information on suitability and implementation, refer to *Self-implement the SoftLoad process* on page 143.

### **11.7.2 Use SoftLoad Customer Support utilities**

This method is appropriate for customers that want to upgrade firmware without the complexity of self-implementing the SoftLoad process, but cannot use NovAtel Application Suite or Manage Web to load firmware. This method requires at a minimum:

- The desired firmware build as an .shex file
- The utility – `srec2softload_dev_20160603.exe`
- The receiver must be able to connect to a terminal like RealTerm

## Process for using Customer Support utilities

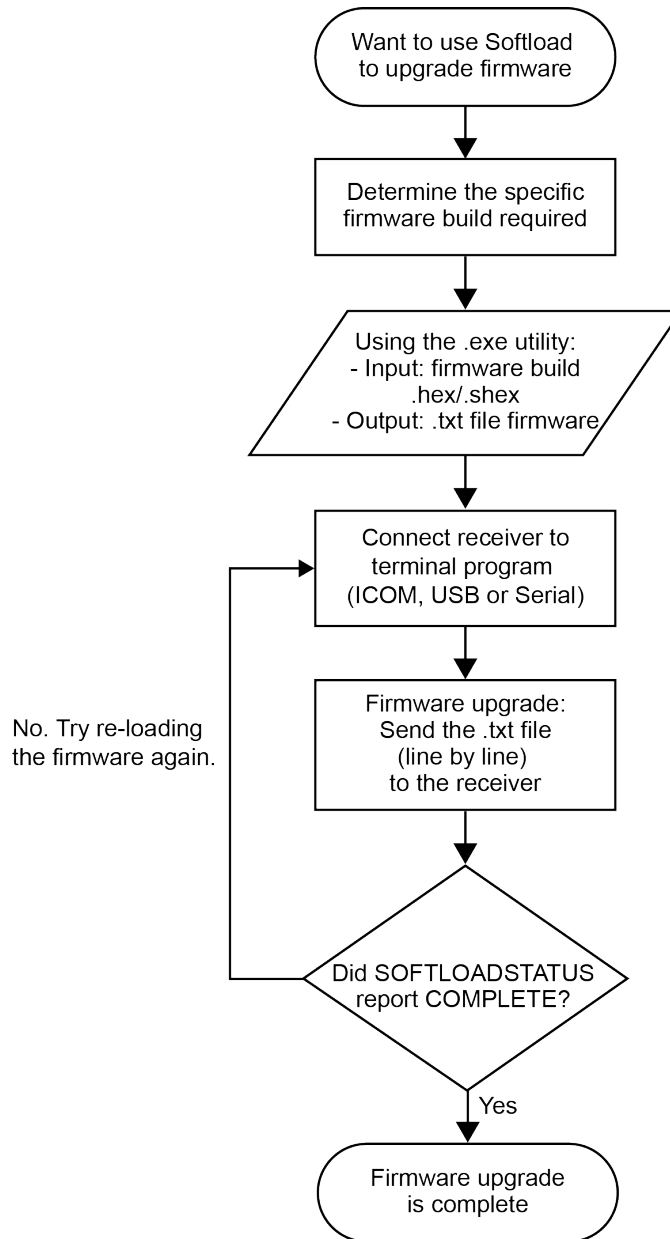

### Using the src2softload utility

1. Contact Customer Support at [novatel.com/support](http://novatel.com/support) and ask about the **src2softload** utility.



At this step the Customer Support representative may assist in directly preparing the txt batch file for you. In this case, continue at *Sending firmware data* on the next page.

2. In a new folder, load the `src2softload_dev_20160603.exe` utility and the desired shex/hex firmware file
3. Create a blank text file (can name it as desired, e.g. "softload\_OM7MR0703RN0000.txt"). This text file will be the output from the utility where the batch script will be converted and placed.
4. In that folder, open up a Powershell window and enter:

```
<softload utility name> <input shex/hex file> <output blank text
file>
```

For example: `.\srec2softload_dev_20160603 .\OM7MR0703RN0000.shex .\softload_OM7MR0703RN0000.txt`

5. Press **Enter** and the output text file will be populated with the batch file. A confirmation message/response will appear.

### Sending firmware data

It can take 30 minutes to 1 hour to complete sending the entire firmware to the receiver. RealTerm is preferred, but other terminal programs may be used (at user's discretion).

1. Download RealTerm from: [sourceforge.net/projects/realterm/](http://sourceforge.net/projects/realterm/).
2. Open RealTerm, go to the Port tab.
3. Choose the COM port to be used (if using USB or Serial) along with the appropriate baud rate. If using Ethernet, type the IP address right where the Port dropdown menu is. Baud rate is not required to be specified if using Ethernet.



**If using ICOM (Ethernet), ensure the Winsock option is set to Raw, otherwise the binary part of firmware will be encoded and produce CRC errors. This is not necessary if connecting via serial or USB.**



If using ICOM (Ethernet), a connection will be verified by the [ICOM1] string showing up at the top.



If using serial or USB, screen will appear empty.

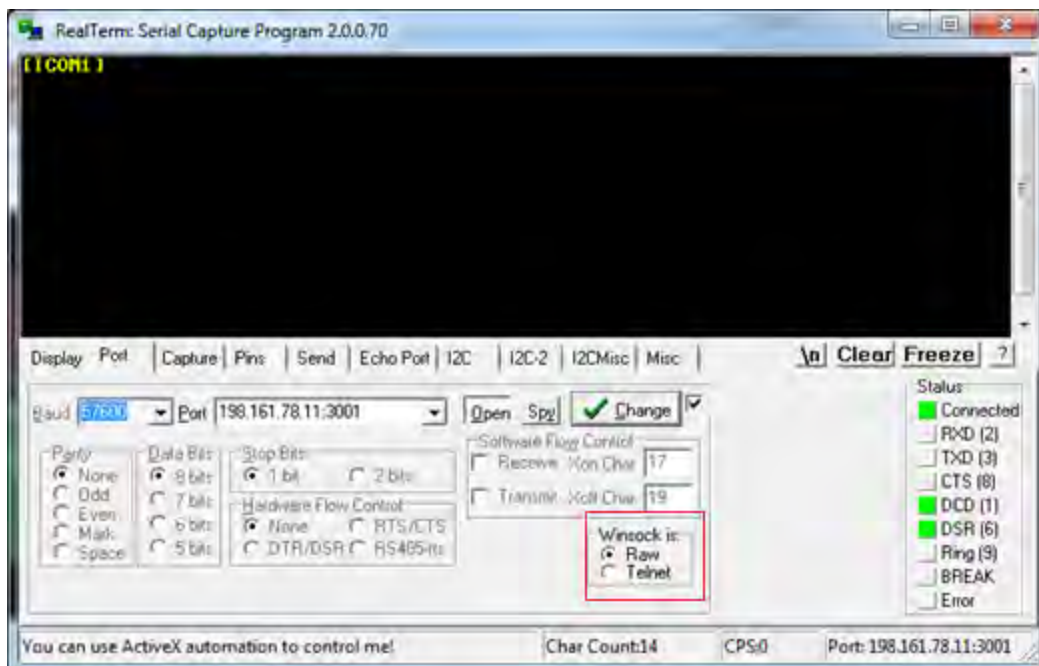

- Go to the **Send** tab. Click on the ellipsis button to the right of the **Dump File to Port** drop down menu.

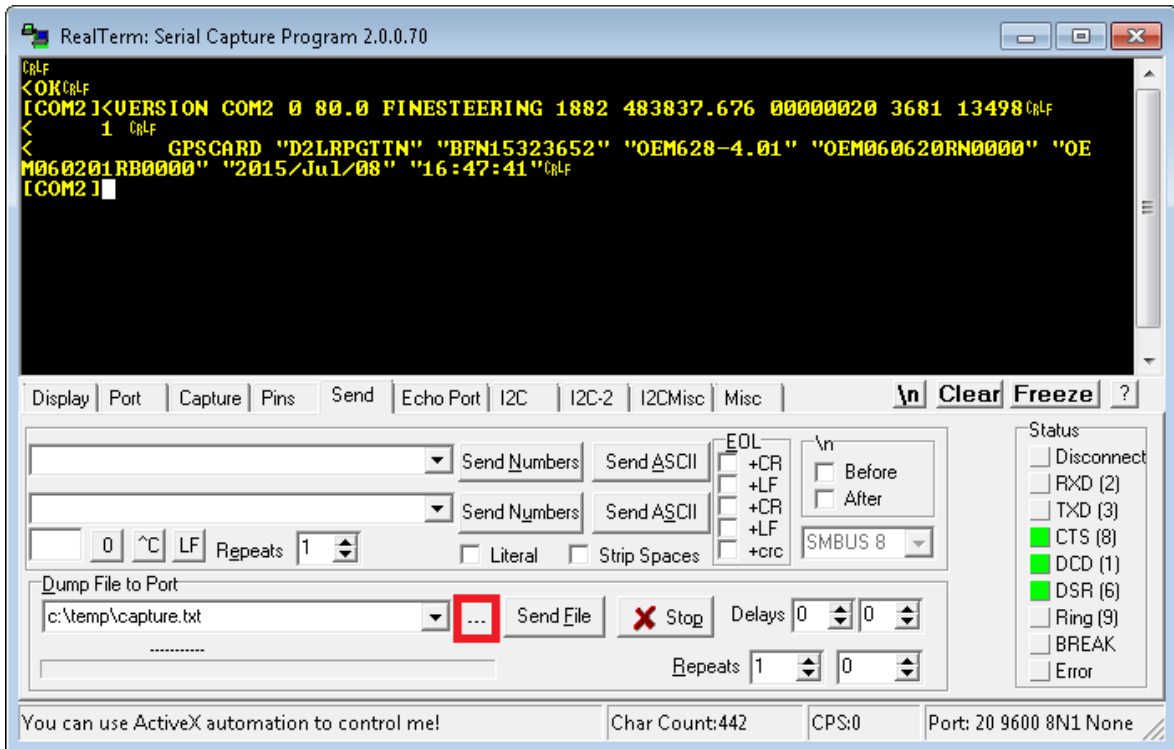

**If connecting to receiver via serial or USB, ensure a delay of at least 20 msec is specified between each line. This is NOT necessary for ICOM connections; it will just cause the firmware to take longer to load. The option can be found in the *Send* tab of RealTerm.**

Delays 0 20

- Select the batch file containing the ASCII and binary SOFTLOAD records and click on **Send File**.



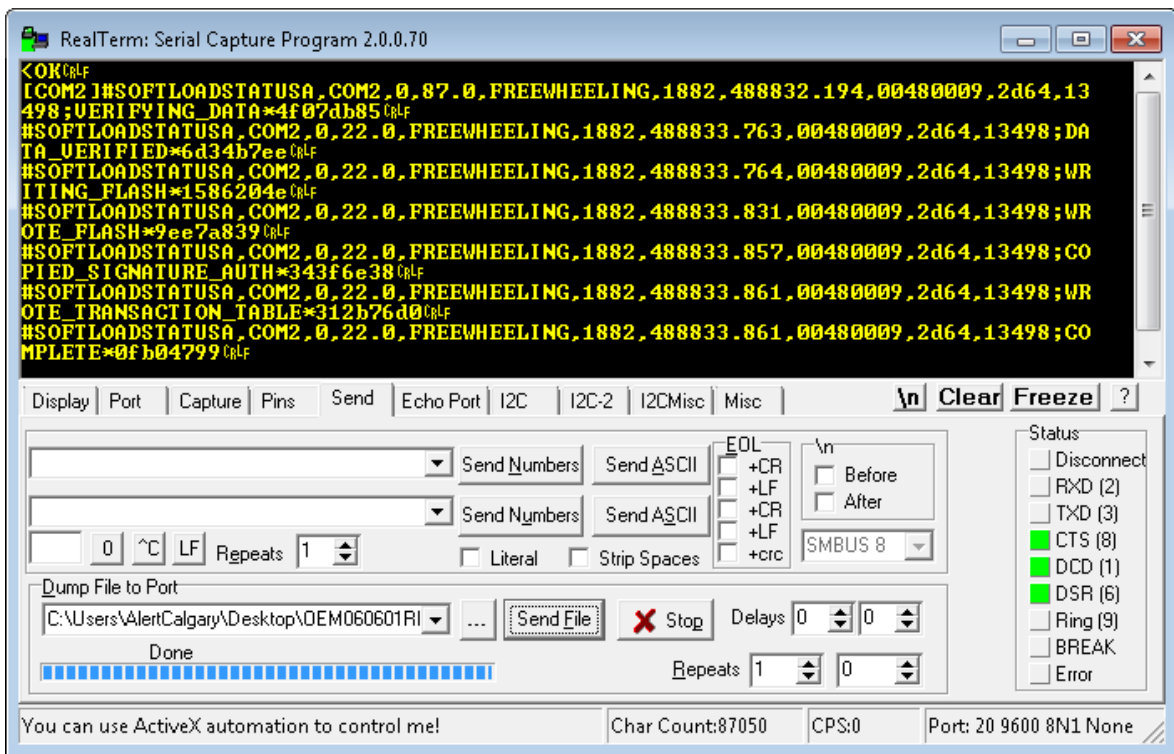

8. Once SOFTLOADSTATUS has confirmed the process is COMPLETE, send the **RESET** command.
9. Once the receiver has been reset, send the **LOG VERSION** command to confirm the desired firmware version has been installed.

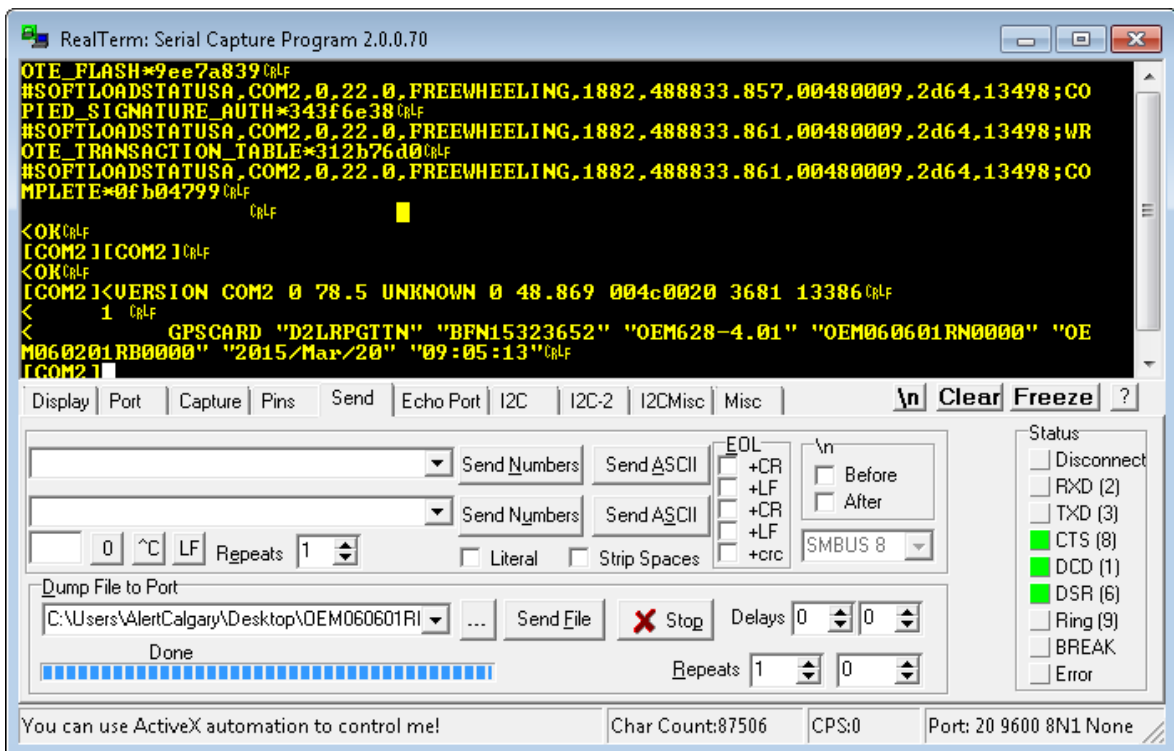

### SoftLoad errors

It is possible for errors to occur during the SoftLoad update. All command responses should be checked to verify all issued commands were accepted. The SoftLoad status should also be monitored in the

**SOFTLOADSTATUS** log. Any status enum value greater than the ERROR status indicates an error has occurred during the SoftLoad update. In the event of an error, the SoftLoad update should be restarted by issuing a **SOFTLOADRESET** command or normal operation can be restored by resetting the receiver.

In rare cases after a SoftLoad error, the boot code may not be able to determine which is the latest firmware to be executed. To protect against this, SoftLoad does not erase the previous valid firmware image from flash on the receiver. In such cases, the boot code will execute the old image and raise the "Safe Mode" error (see **RXSTATUS** log). If that error is detected, simply restart the SoftLoad process to reload the new firmware image and the error will be resolved.

### 11.7.3 Self-implement the SoftLoad process

This method is appropriate for users with deeply embedded systems and that want to customize the firmware updating process to their application. C++ source code is available to provide example code of processing S-Records and converting them to NovAtel format commands.

Contact Customer Support at [novatel.com/support](http://novatel.com/support) and ask about the srec2softload utility. The C++ source code can then be customized to your application.

#### SoftLoad commands and logs

Refer to the [OEM7 Commands and Logs Reference Manual](#) for detailed log and command information.

Command	Description
SOFTLOADRESET	Initiate a new SoftLoad process
SOFTLOADSREC	Send an S-Record to the receiver for the SoftLoad process
SOFTLOADDATA	Send firmware image data to the receiver for the SoftLoad process
SOFTLOADCOMMIT	Complete the SoftLoad process
SOFTLOADSETUP	Send configuration information to the receiver for the SoftLoad process. This command is not required when working with a *.shex file
SOFTLOADFILE	Load a firmware image that has been loaded onto the internal storage of the receiver.

Log	Description
SOFTLOADSTATUS	Provides status updates for the ongoing SoftLoad process

Each command and log can be used in abbreviated ASCII, ASCII or binary format, with the exception of SOFTLOADDATA, which should only be used in binary format.

#### File types

Firmware data is stored in \*.shex files as ASCII data in the form of S-Records, based on the Motorola S-Record format. The \*.shex file includes a digital signature for the firmware.

#### Working with S-Records

Each S-Record has a header indicating the type of information contained in the record.

Records beginning with S0, S5 and S7 contain metadata about the firmware image, such as version information and which card types are supported by the firmware image.

**Example S0 Record**

```
S0~V~OM7MR0400RN0000
```

**Example S5 Records**

```
S50000
S503D9FE25
S5033158D5A
```

**Example S7 Records**

```
S70000
S70500000000FA
```

Records beginning with S3 contain the actual firmware image data. Aside from the header, each pair of characters forms the ASCII representation of a binary byte. The format is as follows:

<b>S3</b>	<b>LL</b>	<b>AAAAAAA</b>	<b>DDDDDDDD...DDDDDDDD</b>	<b>CC</b>
				Check Sum
			Little Endian Data. These bytes are copied into the "data" field of the <b>SOFTLOADDATA</b> command	
		4 - Byte Address. Set this as the value of "offset" in the <b>SOFTLOADDATA</b> command		
	Length. This is the hexadecimal number of character pairs to follow in the record. This value minus 4 bytes for the address and 1 byte for the check sum is copied into the "data length" field of the <b>SOFTLOADDATA</b> command			
Header				

**Sending firmware data**

The **SOFTLOADSREC** and **SOFTLOADDATA** commands can be used to send firmware data from \*.shex files to the receiver.

S0, S5 and S7 S-Records should be sent directly to the receiver using the **SOFTLOADSREC** command, by enclosing the S-Record in quotation marks and issuing the command to the receiver, as follows:

```
SOFTLOADSREC "<S-RECORD>"
```

S3 records can be sent individually to the receiver using the **SOFTLOADSREC** command. Alternatively, the data from an S3 record can be parsed and packaged together with data from other S3 records into a binary **SOFTLOADDATA** command. Packaging data parsed from multiple S3 records into a binary **SOFTLOADDATA** command can result in improved firmware update times as each S3 record contains only a small number of bytes of firmware data. A single **SOFTLOADDATA** command can package up to 4096 bytes of firmware data from multiple S3 records, whereas a single **SOFTLOADSREC** command contains a maximum of 28 bytes of firmware data from a single S3 record.

Multiple S3 records can be packaged into a single **SOFTLOADDATA** command as long as the data from one S3 record follows immediately after the previous record. That is, the address from the current S3 record must equal the address from the previous S3 record plus the data length of the previous S3 record. If the data is not consecutive then the **SOFTLOADDATA** command can be sent with the amount of data it has packaged up to that point. Subsequent data can be packaged in a new **SOFTLOADDATA** command. Within the **SOFTLOADDATA** command, the "offset" field remains the address of the first S3 record and the "data" and "data length" are updated to include the new data.

The \*.shex file data may contain many gaps and jumps. For example, in many NovAtel \*.shex files, data for address 0x000\_00000 is stored near the very end of the file.

**Example packaging multiple S3 Records in a SOFTLOADDATA command**

Start a new **SOFTLOADDATA** command

```
S32100407AD48FCA63034B80F5CE0C36507DE3D8DCC0C6C0C00515D74BCACF2F2949E1
```

Address: 0x00407AD4 Num Data Bytes: 0x21 – 0x01 – 0x04 = 0x1C

```
S32100407AF04CCA4985F0F7B081E41D9B7D806C26989AE2D4E4CCBCB47C10FBFD3E43
```

Previous Address + Previous Num Bytes = 0x00407AD4 + 0x1C = 0x00407AF0

Address: 0x00407AF0 Num Data Bytes: 0x1C

Add data to existing **SOFTLOADDATA** command

```
S30D00407B0CDE0400A6374D5BFFC5
```

Previous Address + Previous Num Bytes = 0x00407AF0 + 0x1C = 0x00407B0C

Address: 0x00407B0C Num Data Bytes: 0x0D – 0x01 – 0x04 = 0x08

Add data to existing **SOFTLOADDATA** command

```
S3210000000007F0A7F1F4060000147B4000F49217813C7BB00014493F005C00000009
```

Previous Address + Previous Num Bytes = 0x00407B0C + 0x08 = 0x00407B14

Address: 0x00000000 Num Data Bytes: 0x1C

Requires new **SOFTLOADDATA** command because address does not match previous address + previous number of data bytes

Send existing **SOFTLOADDATA** command, and start a new **SOFTLOADDATA** command

```
S3210000001C80040000E001000030000000082B0100D8060000E4060000C806000063
```

Address: 0x0000001C Num Data Bytes: 0x1C

Previous Address + Previous Num Bytes = 0x00000000 + 0x1C = 0x0000001C

Add data to existing **SOFTLOADDATA** command

The **SOFTLOADDATA** command must be sent as a NovAtel binary format command.

### SoftLoad update method

This section describes the sequence of commands that are issued to the receiver when updating using a \*.shex file.



The response for each command must be processed before sending the next command so as to determine if the command was accepted or rejected, and to wait for the receiver to complete the operation. Responses to SoftLoad commands are guaranteed to be output from the receiver within a specific time, which varies by command. Refer to specific SoftLoad command for more information on responses and the timeout values for SoftLoad commands.

1. Open a connection to any port on the receiver (COM, USB or ICOM) with the input and output INTERFACEMODE set to NOVATEL.
2. Request the SOFTLOADSTATUS log using the following command:
 

```
LOG SOFTLOADSTATUSA ONCHANGED
```
3. Initialize SoftLoad with a **SOFTLOADRESET** command. This command stops all tracking on the receiver to ensure sufficient memory is available for the loading process. An RXSTATUSEVENTA log reports a SoftLoad In Progress status.
4. Open the \*.shex firmware file.
5. Read each line of the \*.shex firmware file.

- a. Send S0, S5 and S7 S-Records directly to the receiver using the **SOFTLOADSREC** command. The S-Record must be enclosed in quotation marks:  
**SOFTLOADSREC "<S-RECORD>"**  
Data within S0 records can also be sent to the receiver by converting them to **SOFTLOADSETUP** commands. Refer to the **SOFTLOADSETUP** command in the [OEM7 Commands and Logs Reference Manual](#) for details on how to convert from S0 S-Records to **SOFTLOADSETUP** commands.
  - b. S3 S-Records should be parsed and packaged into a **SOFTLOADDATA** command.
6. Send the **SOFTLOADCOMMIT** command after all data from the \*.shex file has been transferred to the receiver. The SOFTLOADSTATUS log reports the status of the loading process. Wait for a SOFTLOADSTATUS log to indicate the status is COMPLETE. The COMPLETE status or an error is guaranteed to be output from the receiver within 300 seconds from the time the **SOFTLOADCOMMIT** command was received by the receiver.
  7. Send the auth code for the newly downloaded image using the **AUTH** command. This is only required if there is not already a signature auth code on the receiver as signature auth codes are maintained through a SoftLoad update. See *Authorization code* on page 131 for details on Auth Codes.

```
AUTH ADD_DOWNLOAD <AUTH CODE>
```

8. Reset the receiver using any of the following methods:
  - Enter the **RESET** command
  - Enter the **FRESET** command
  - Power-cycle the receiver

Once the receiver resets, the new version of firmware is active.

The SoftLoad process can be safely canceled at any time using the **SOFTLOADRESET** command or by otherwise resetting the receiver. Once the COMPLETE status is reported by SOFTLOADSTATUS, the new firmware image will be run after the receiver is reset.

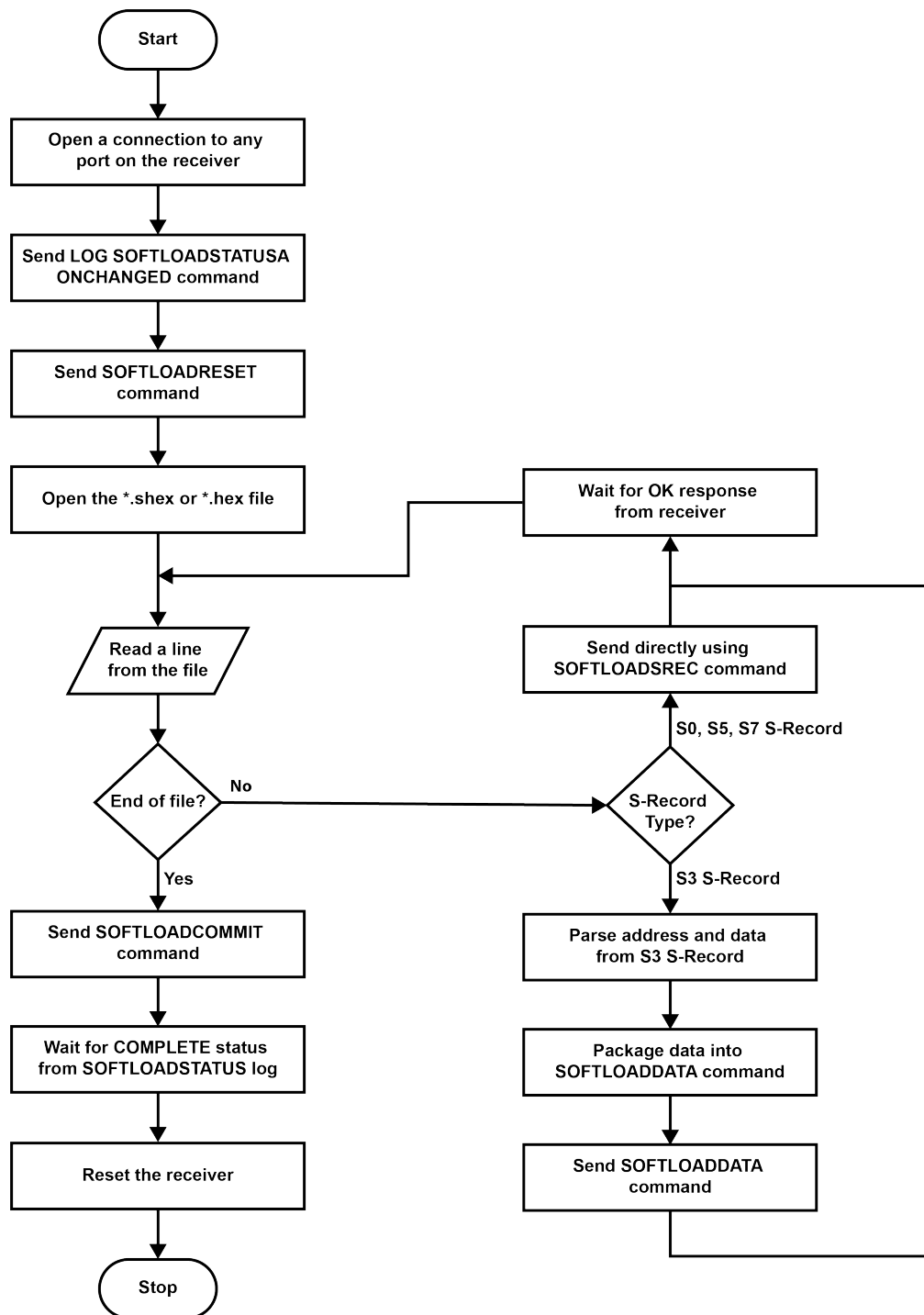

## SoftLoad errors

It is possible for errors to occur during the SoftLoad update. All command responses should be checked to verify all issued commands were accepted. The SoftLoad status should also be monitored in the **SOFTLOADSTATUS** log. Any status enum value greater than the ERROR status indicates an error has occurred during the SoftLoad update. In the event of an error, the SoftLoad update should be restarted by issuing a **SOFTLOADRESET** command or normal operation can be restored by resetting the receiver.

In rare cases after a SoftLoad error, the boot code may not be able to determine which is the latest firmware to be executed. To protect against this, SoftLoad does not erase the previous valid firmware image from flash on the receiver. In such cases, the boot code will execute the old image and raise the "Safe Mode" error (see

**RXSTATUS** log). If that error is detected, simply restart the SoftLoad process to reload the new firmware image and the error will be resolved.

## 11.8 Update Manage Web

Manage Web is hosted on the OEM7 receiver. To update Manage Web, a new Manage Web software package is loaded onto the receiver.

### 11.8.1 Update Manage Web content using NovAtel Application Suite

To update Manage Web on the receiver:

1. Obtain the new Manage Web file.

The latest version of Manage Web content is available on the NovAtel website ([novatel.com/support](http://novatel.com/support)).



Copy the Manage Web file to the device's local drive before uploading.

2. Connect a computer to the receiver using a serial (COM) cable, USB cable or Ethernet connection.
3. Start NovAtel Application Suite on the computer.
4. Use NovAtel Application Suite to connect to the receiver.

For information about using NovAtel Application Suite, refer to [docs.novatel.com/Tools](http://docs.novatel.com/Tools).

5. On the *Status and Configuration* window, click the **Device** menu and select **Update**.

The *Update* window appears.

6. Click the **Browse** button.
7. Navigate to the directory that contains the new Manage Web file and select the file.
8. Click the **Open** button.

The Update window appears with the name of the selected file in the Select File field.

9. Click the **Apply** button.

After the new software is loaded, the receiver will restart.

### 11.8.2 Update Manage Web content using Manage Web

To update Manage Web on the receiver:

1. Obtain the new Manage Web file.

The latest version of Manage Web content is available on the NovAtel website ([novatel.com/support](http://novatel.com/support)).



Copy the Manage Web file to the device's local drive before uploading.

2. Use a Wi-Fi capable device (such as a laptop, tablet or smart phone) to connect to the receiver's Wi-Fi access point. The SSID and password for the receiver Wi-Fi are on a label on the receiver.

Alternately, connect the receiver to a computer using an Ethernet connection.

3. Open a web browser and enter **192.168.19.1** in the address (URL) bar of the browser.

If using an Ethernet connection, enter the IP address assigned to the receiver.

The Manage Web Home page appears.

4. Click the Menu icon and select **Update**.
5. Click the **Select File** button
6. Navigate to the folder in which the new Manage Web software to load is stored and select the software file.
7. Click the **Apply** button.

After the new software is loaded, the receiver will restart.

## 11.9 Upgrading using an Auth-Code

An authorization code (auth-code) enables (unlocks) model features.

An auth-code can be entered using NovAtel Application Suite, Manage Web or the command line interface.

### 11.9.1 Entering an Auth-Code using NovAtel Application Suite

1. Obtain the new auth-code from NovAtel Sales or your local NovAtel dealer.
2. Connect a computer to the receiver using a serial (COM) cable, USB cable or Ethernet connection.
3. Start NovAtel Application Suite on the computer.
4. Use NovAtel Application Suite to connect to the receiver.

For information about using NovAtel Application Suite, refer to [docs.novatel.com/Tools/Content/ToolsSuite/Overview.htm](https://docs.novatel.com/Tools/Content/ToolsSuite/Overview.htm).

5. Click the **Device** menu and select **Details**.

The **Details** window appears.

6. On the *Authorizations* tile, enter the new Auth Code in the **Apply New Auth Code** box.
7. Click the **Apply** button to save the changes to the receiver.

The receiver will restart when a new Auth Code is applied.

### 11.9.2 Entering an Auth-Code using Manage Web

1. Obtain the new auth-code from NovAtel Sales or your local NovAtel dealer.
2. Use a Wi-Fi capable device (such as a laptop, tablet or smart phone) to connect to the receiver's Wi-Fi access point. The SSID and password for the receiver Wi-Fi are on a label on the receiver.
3. Open a web browser and enter **192.168.19.1** in the address (URL) bar of the browser.

If using an Ethernet connection, enter the IP address assigned to the receiver.

The Manage Web Home page appears.

4. Click the Menu icon and select **Details**.

The **Details** window appears.

5. Open the **Authorizations** tile.
6. Enter the new Auth Code in the **Apply New Auth Code** box.
7. Click the **Apply** button to save the changes to the receiver.

The receiver will restart when a new Auth Code is applied.

### 11.9.3 Entering an Auth-Code Using the Command Line

The **AUTH** command is used to enter an auth-code. The upgrade can be performed directly through the NovAtel Application Suite command line or from any other communications program.



Refer to *Format of firmware files* on page 132 for details on updating versus upgrading.

1. Power up the OEM7 receiver and establish communications.
2. Issue the **LOG VERSION** command to verify the current model, firmware version and serial number (refer to *Authorization code* on page 131 for instructions on obtaining).
3. Issue the **AUTH** command, followed by the auth-code and model type (refer to *Authorization code* on page 131 for details on obtaining any auth-code). The syntax is as follows:

```
auth <your auth-code here>
```

where **auth** is a command that enables model upgrades and auth-code is the upgrade authorization code, expressed as follows:

```
XXXXXX,XXXXXX,XXXXXX,XXXXXX,XXXXXX,MODEL,EXPDATE
```

where:

- Each X character is a case-insensitive ASCII character.
- The MODEL string is a maximum of 15 characters long and represents the model enabled by the auth-code.
- The EXPDATE string is the auth-code's expiry date, in YYMMDD format

Example:

```
auth 7WBMBK,887CB6,K5J3FH,5DF5P2,42PW8G,D1SB0GTT0,121211
```

When the **AUTH** command is executed, the OEM7 receiver reboots. Issuing the **LOG VERSION** command confirms the new upgrade model type and firmware version number.

If communicating using NovAtel Application Suite, the connection must be closed and reopened using the *Devices* window.

# Appendix A SMART7 technical specifications

**Table 21: SMART7 physical description**

Physical		
Size		220 L mm x 192 W mm x 66 H mm
Weight	SMART7	<1.1 kilograms
NovAtel hardware options	SMART7	
	SMART7-I	
	SMART7-W	
	SMART7-S	
	SMART7-SI	



These specifications apply to the SMART7 and SMART7-S.

See the following sections for more information about the SMART7:

- *SMART7 performance specifications* on the next page
- *SMART7 mechanical specifications* on page 156
- *SMART7 environmental and electrical specifications* on page 158
- *SMART7 data communication specifications* on page 159
- *SMART7 strobe specifications* on page 160

For information about the cable available for the SMART7, see the following:

- *SMART Antenna interface cable (optional accessory)* on page 161

## A.1 SMART7 performance specifications

All specifications subject to GNSS system characteristics.

**Table 22: SMART7 receiver performance**

Accuracy			
Horizontal position accuracy <sup>1</sup>		<b>RMS</b>	<b>95%</b>
	Single point L1/L2	1.2 m	2.4 m
	SBAS <sup>2</sup>	0.6 m	1.2 m
	DGPS	0.4 m	0.8 m
	TerraStar-L <sup>3</sup>	40 cm	50 cm
	TerraStar-C PRO <sup>3</sup>	2.0 cm	2.5 cm
	TerraStar-X <sup>3</sup>	2.0 cm	2.5 cm
	RTK	1 cm + 1 ppm	2.5 cm + 1 ppm
Pass to pass accuracy <sup>1</sup>		<b>RMS</b>	<b>95%</b>
	Single Point L1/L2 GLIDE <sup>4</sup>	–	35 cm
	TerraStar-L <sup>3</sup>	–	15 cm
	TerraStar-C PRO <sup>3</sup>	–	2.0 cm
	RTK	1 cm + 1 ppm	2.5 cm + 1 ppm

1. Typical values. All position and velocity RMS values are based on Horizontal position accuracy. Performance specifications are subject to GNSS system characteristics, Signal-in-Space (SIS) operational degradation, ionospheric and tropospheric conditions, satellite geometry, baseline length, multipath effects and the presence of intentional or unintentional interference sources

2. GPS only.

3. TerraStar subscriptions are available from NovAtel or TerraStar. RMS/95% accuracy under ideal conditions and may vary upon users geographic region, ionosphere activity, scintillation levels or unintentional interference sources.

4. Pass-to-pass accuracy over a period of 900 seconds when using GLIDE. GLIDE is a relative positioning filter specifically designed for use in open sky pass to pass applications. Absolute accuracy is not guaranteed.

			Code	Carrier
	Measurement precision (RMS) <sup>1</sup>	GPS	L1 C/A	4 cm
L2 P(Y)			8 cm	1.0 mm
L2C			8 cm	1.0 mm
GLONASS		L1 C/A	15 cm	1.5 mm
		L2 P	8 cm	1.5 mm
		L2 C/A	8 cm	1.5 mm
Galileo		E1	3 cm	0.5 mm
		E5a	3 cm	0.75 mm
		E5b	3 cm	0.75 mm
		E5 AltBoc	3 cm	0.75 mm
BeiDou		B1I	4 cm	0.5 mm
		B1C	3 cm	0.5 mm
		B2I	4 cm	0.5 mm
		B2a	3 cm	0.5 mm
		B2b <sup>2</sup>	3 cm	0.5 mm
Time accuracy <sup>3</sup>	20 ns RMS			
Velocity accuracy <sup>4</sup>	<0.03 m/s RMS			

1. Measurement precision should be compared with measurements using the same correlator spacing.

2. Under good CN0 conditions, e.g. 44 dBHz.

3. Time accuracy does not include biases due to RF or antenna delay.

4. Export licensing restricts operation to a maximum of 515 metres per second.

Signals		
Signals tracked	GPS	L1 C/A, L2P, L2C
	GPS (optional)	L1C, L5
	GLONASS	L1 C/A, L2 C/A, L2P
	GLONASS (optional)	L3 CDMA
	BeiDou (optional)	B1I, B1C, B2I, B2a, B2b
	Galileo (optional)	E1, E5 AltBOC, E5a, E5b
	QZSS	L1 C/A, L2C
	QZSS (optional)	L1C, L5
	SBAS	L1
	SBAS (optional)	L5
	L-Band	Up to 5 channels <sup>1</sup>
Signal reacquisition	L1	0.5 s typical
	L2	<1.0 s typical
Time to First Fix	Hot: <20 s typical (Almanac and recent ephemeris saved and approximate position and time entered) Cold: <34 s typical (No almanac or ephemeris and no approximate position or time)	
Data		
Maximum data rate	Measurements	up to 20 Hz
	Position	up to 20 Hz



The IMU performance specifications apply to the SMART7-S and SMART7-SI only.

**Table 23: SMART7-S IMU performance**

Gyroscope performance	
Technology	MEMS
Dynamic range	150 °/second
Bias instability	3.5 °/hour
Angular random walk	0.1 °/√hour

1. Currently the receiver can track up to 3 L-Band channels.

Accelerometer performance		
Technology	MEMS	
Dynamic range	5 g	
Bias instability	0.1 mg	
Velocity random walk	0.05 m/s/ $\sqrt{\text{hour}}$	
Attitude accuracy		
	RMS	95%
Roll	0.03	0.06
Pitch	0.03	0.06
Heading	0.1	0.5



The bias instability, angular random walk and velocity random walk specifications are from room temperature Allan variance method.

## A.2 SMART7 mechanical specifications

- Figure 39: SMART7 dimensions below
- Figure 40: SMART7-S and SMART7-SI center of navigation on the next page



In the following diagrams, the dimensions are in millimetres.

**Figure 39: SMART7 dimensions**

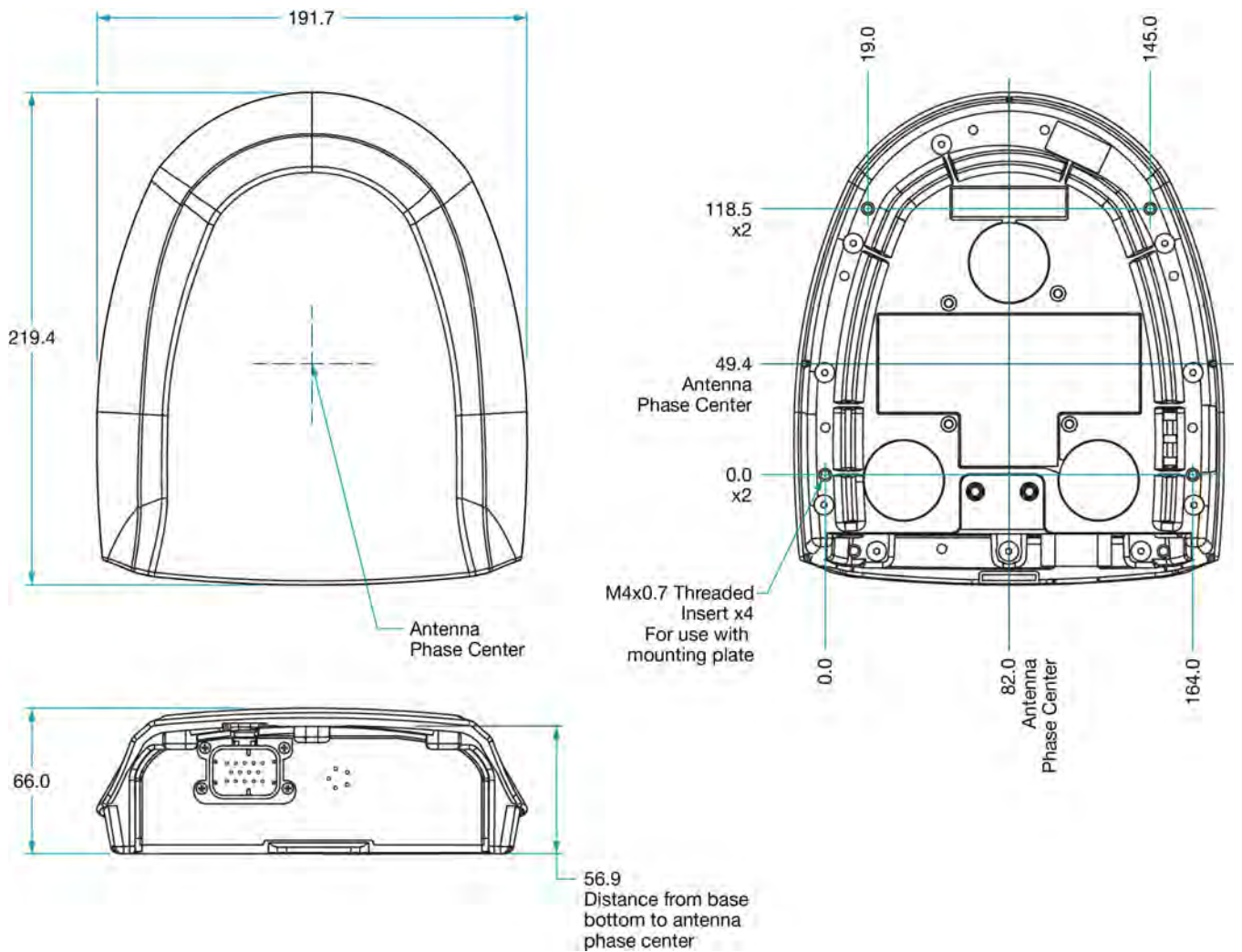
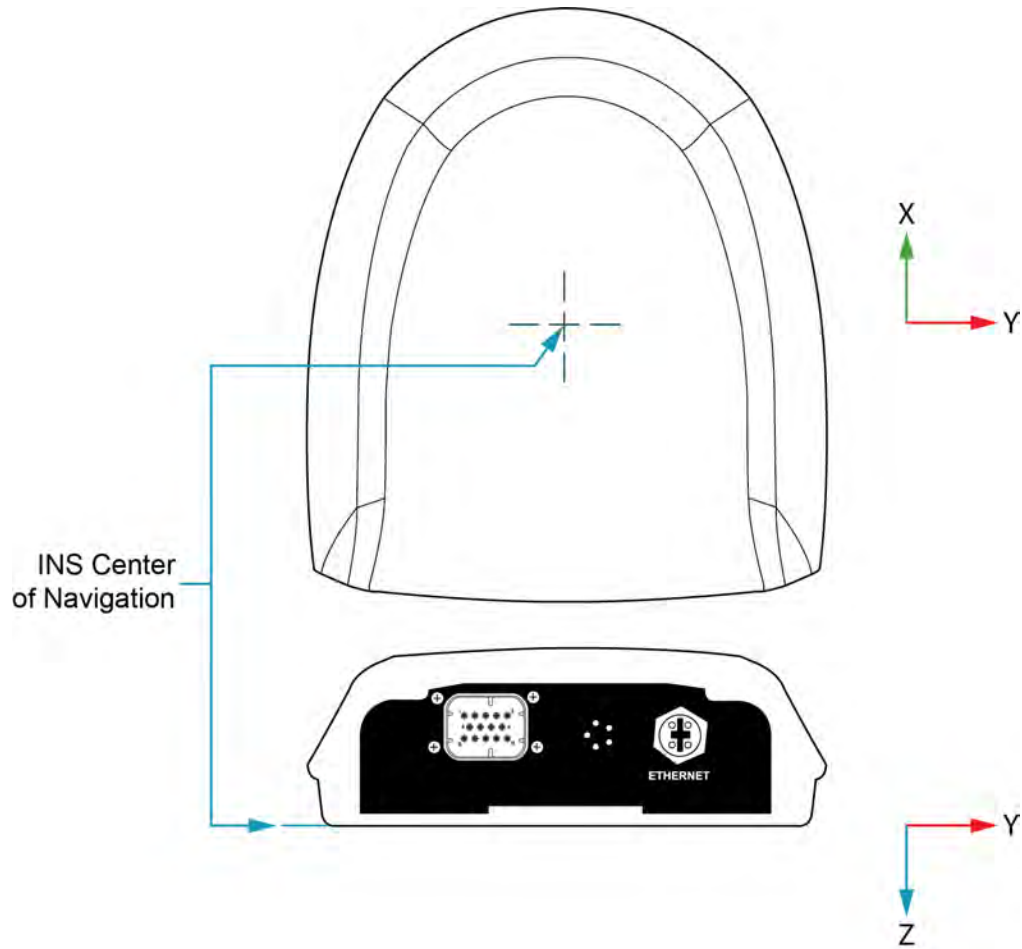



Figure 40: SMART7-S and SMART7-SI center of navigation



The horizontal component (X and Y axis) of the INS center of navigation is in the same location as the antenna phase center. Refer to the *Figure 39: SMART7 dimensions* on the previous page for the measurements.

## A.3 SMART7 environmental and electrical specifications

**Table 24: SMART7 environmental specifications**

Environmental	
Operating temperature	-40°C to +70°C
Storage temperature	-45°C to +80°C
Humidity	MIL-STD-810G(CH1), Method 507.6
Immersion	MIL-STD-810G(CH1), Method 512.6
Ingress protection rating	IP67 IP69  <b>IP67 and IP69 ratings require that the cable is connected to the SMART7.</b>
Shock	MIL-STD-810G(CH1), Method 516.7
Solar radiation	IEC 60950-22 8.2, ISO 9022-9, Method 20, Severity Degree 03
Salt fog	IEC 60068-2-11
Sand and dust	MIL-STD-810G(CH1), Method 510.5
Random vibration	MIL-STD-810G(CH1), Method 514.7

**Table 25: SMART7 power requirements**

Power	
Voltage	+7 to +30 VDC
Power consumption	4 W typical, value for GPS L1/L2  These are typical values using serial ports without interference mitigation. These values can change with the number of satellites in view, firmware version, data logging rates and features in use. Use them as a guide for what you might expect but not as absolute values

## A.4 SMART7 data communication specifications

**Table 26: Data communications interfaces**

COM1, COM2, COM3	
Electrical format	RS-232
Data rates <sup>1</sup>	2400, 4800, 9600 (default), 19200, 38400, 57600, 115200, 230400 bit/s
Signals supported	COM1_Tx, COM1_Rx, COM2_Tx, COM2_Rx, COM3_Tx, COM3_Rx
SMART7 port	14-Pin Tyco Ampseal
CAN bus	
Electrical format	ISO 11898-2
Data rates	1 Mbps maximum CAN bus throughput is determined by slowest device on the bus
SMART7 port	14-Pin Tyco Ampseal
ETHERNET	
Physical layer	10BASE-T/100BASE-TX
SMART7 port	M12 D-code male
Wi-Fi access point	
Security	WPA2
Encryption	AES
Wi-Fi client point	
Security	OPEN, WPA, WPA2
Encryption	TKIP, AES CCMP

1. Data rates higher than 115200 bit/s are not supported by standard PC hardware. Special PC hardware may be required for higher rates, including 230400 bit/s and 460800 bit/s.

## A.5 SMART7 strobe specifications

The SMART7 strobe signals are available on the 14-Pin Interface connector. Pulse Per Second (PPS) strobes provide synchronization signal.



Refer to *SMART Antenna interface cable (optional accessory)* on the next page for pin out details.

**Table 27: SMART7 strobes description**

Strobes	Input/Output	Comment
Emulated Radar (ER)	Output	0VDC to VBATT+ Use the <b>RADARCONFIG</b> command to configure ER. Emulated Radar pulses are output through the <i>SMART Antenna interface cable (optional accessory)</i> on the next page and the <b>RADARSTATUS</b> log.
PPS	Output	3.3V CMOS A time synchronization output. This is a pulse where the leading edge is synchronized to receiver calculated GNSS Time. The polarity, period and pulse width can be configured using the <b>PPSCONTROL</b> command.

## A.6 SMART Antenna interface cable (optional accessory)

The NovAtel part number for the SMART Antenna interface cable is 01019944. This cable provides access to all of the signals available on the SMART Antenna 14-pin Tyco Ampseal connector. The exposed wires (BATT+ and BATT-) can then be connected to a vehicular power circuit (or equivalent) protected by a 5 A slow blow fuse (user supplied).

The following SMART Antennas use this cable:

- SMART7
- SMART7 with RELAY7
- SMART2



The SMART Antenna interface cable is also compatible with the Ag-Star, SMART6 and SMART6-L.



In the following diagram, the dimensions are in millimetres.

**Figure 41: SMART Antenna interface cable**

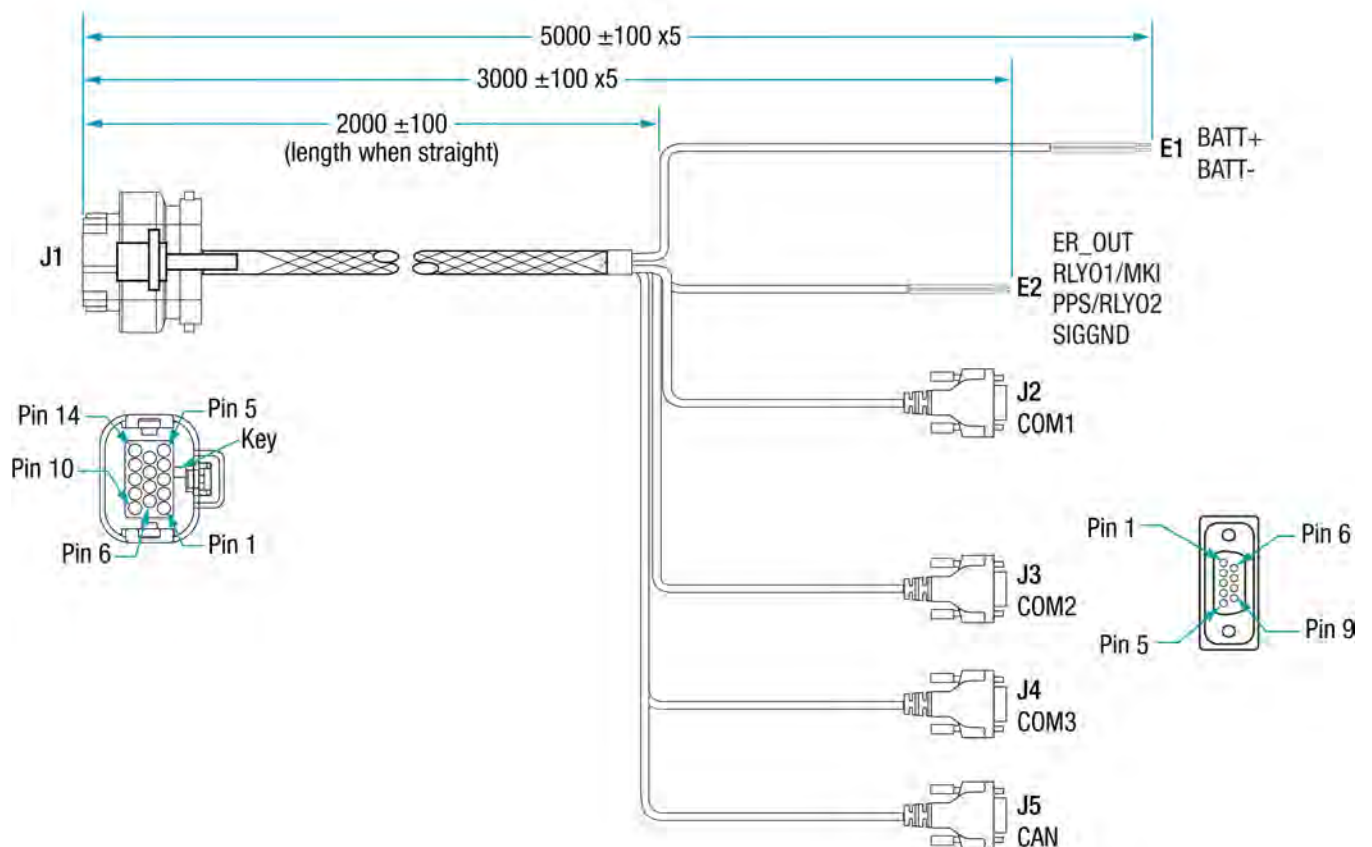



This cable is also used when the RELAY7 is connected to the SMART7. When the RELAY7 is connected to the SMART7, PPS and COM3 are not available.

**Table 28: SMART Antenna interface cable connector pinout**

Signal name	J1	J2	J3	J4	J5	E1	E2
COM1-TXD	1	2					
COM1-RXD	2	3					
COM2-TXD	3		2				
COM2-RXD	4		3				
COM3-TXD	8			2			
COM3-RXD	13			3			
CAN+	6				7		
CAN-	7				2		
SIGGND	5	5					
SIGGND	5		5				
SIGGND	5			5			
SIGGND	5				3		
SIGGND	5						SIGGND
EMD RADAR OUT (E2)	10						ER_OUT
RELAYO1/MARK INPUT (E2) <sup>1</sup>	11						MKI
PPS/RLYO2 (E2)	12						PPS
PWR RET (GND) (E1)	9					BATT-	
PWR INPUT (E1)	14					BATT+	

**Table 29: 14-pin interface signal specifications**

Signal name	Signal specifications
CAN	SAE J1939/ ISO 11783/ ISO 11898 Compatible
PPS Output	3.3 V CMOS Logic Compatible
Ground Speed Output	High= Supply Voltage Maximum Low= 1.5 V Maximum Load= 3K Ohm Minimum

1. The Mark Input is not available on the SMART7.

### ***A.6.1 SMART Antenna custom cable recommendation***

To create a custom cable for a SMART Antenna, a specific connector is required on the end of the cable. See the following table for information about this connector.

**Table 30: I/O connector**

<b>Connector</b>	<b>Description</b>	<b>Commercial part number</b>
J1	AMP Seal 14-pin Plug	776273-1

## A.7 SMART7 mounting plate specifications

The optional SMART7 mounting plate is NovAtel part number 1020089.



In the following diagram, the dimensions are in millimetres.

**Figure 42: SMART7 mounting plate dimensions**

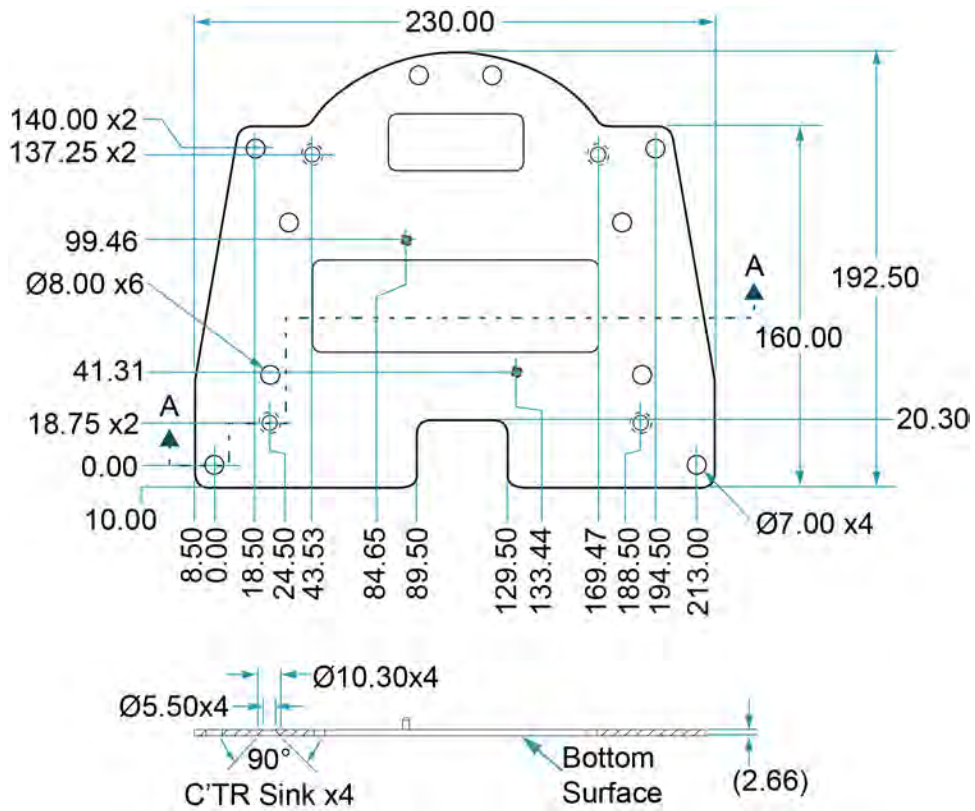

Refer to *Mounting and orienting the SMART7* on page 27 for installation details.

## Appendix B SMART7 accessories and replacement parts

---

The following tables list the replacement parts available for your NovAtel SMART7 receiver. For assistance or to order additional components, contact your local NovAtel dealer or NovAtel Customer Support.

**Table 31: SMART7 hardware options**

Hardware option/part number	Description
SMART7	
SMART7-W	Wi-Fi
SMART7-I	Wi-Fi and Ethernet
SMART7-S	SPAN
SMART7-SI	SPAN, Wi-Fi and Ethernet
01020089	SMART7 Mounting Plate Kit
01019944	SMART7 Interface Cable

**Table 32: RELAY7 accessory products**

Option	Description
RELAY7-400	RTK Radio for use with SMART7, 403-473 MHz
RELAY7-900	RTK Radio for use with SMART7, 902-928 MHz

