



# **PwrPak7 Family Installation and Operation User Manual**

---

# PwrPak7 Family Installation and Operation User Manual

**Publication Number:** OM-20000173

**Revision Level:** v9

**Revision Date:** May 2019

**Firmware Version:** PP7 07.05.04 / EP7PR0504RN0000

To download the latest firmware and/or software visit: [www.novatel.com/support/firmware-downloads](http://www.novatel.com/support/firmware-downloads).

## Warranty

NovAtel Inc. warrants that its GNSS products are free from defects in materials and workmanship, subject to the conditions set forth on our web site: [www.novatel.com/products/warranty/](http://www.novatel.com/products/warranty/) and for the following time periods:

OEM7 <sup>®</sup> Receivers	One (1) Year
GNSS Antenna Series	One (1) Year
Cables and Accessories	Ninety (90) Days
Software Warranty	One (1) Year

## Return Instructions

To return products, refer to the instructions found at: [www.novatel.com/warranty-return](http://www.novatel.com/warranty-return).

## Proprietary Notice

Information in this document is subject to change without notice and does not represent a commitment on the part of NovAtel Inc. The software described in this document is furnished under a licence agreement or non-disclosure agreement. The software may be used or copied only in accordance with the terms of the agreement. It is against the law to copy the software on any medium except as specifically allowed in the license or non-disclosure agreement.

The information contained within this manual is believed to be true and correct at the time of publication.

NovAtel, ALIGN, GLIDE, GrafNav/GrafNet, Inertial Explorer, NovAtel CORRECT, OEM7, PwrPak7, RELAY, SPAN, STEADYLINE, VEXXIS and Waypoint are registered trademarks of NovAtel Inc.

NovAtel Connect, OEM719, OEM729, OEM7500, OEM7600, OEM7700, OEM7720, SMART7, RELAY7 and RTK ASSIST are trademarks of NovAtel Inc.

All other brand names are trademarks of their respective holders.

© Copyright 2019 NovAtel Inc. All rights reserved.

Unpublished rights reserved under International copyright laws.

---

# Table of Contents

## Figures

## Tables

## PwrPak7 Notices

## Customer Support

### Chapter 1 PwrPak7 Overview

1.1 PwrPak7 Connectors .....	23
1.2 PwrPak7 LEDs .....	25
1.3 Related Documents and Information .....	28

### Chapter 2 PwrPak7 Installation

2.1 Shipping Box .....	29
2.2 Additional Equipment Required .....	29
2.3 Optional Accessories .....	29
2.4 PwrPak7 Cables .....	30
2.5 Selecting a GNSS Antenna .....	31
2.6 Choosing a Coaxial Cable .....	31
2.7 Power Supply Requirements for the PwrPak7 .....	32
2.8 PwrPak7 Installation Overview .....	34
2.9 Mounting the GNSS Antenna .....	36
2.9.1 Antenna LNA Power .....	36
2.10 Mount the PwrPak7 .....	37
2.11 Mount the PwrPak7-E1 .....	37
2.12 Connect the PwrPak7 to Data Communication Equipment .....	38
2.12.1 Serial Ports .....	38
2.12.2 USB Ports .....	39
2.12.3 Wi-Fi .....	39
2.12.4 Ethernet Port .....	40
2.12.5 CAN Bus Port .....	40
2.13 Connect I/O Signals to the PwrPak7 .....	41
2.14 Connect Power to the PwrPak7 .....	41
2.14.1 Fuse for the Power Supply .....	42
2.14.2 Vehicle Installation .....	42
2.14.3 Seamless Battery Swap .....	43
2.15 Check that the PwrPak7 is Operating .....	44

---

## Chapter 3 OEM7 Receiver Operation

3.1	Communications with the Receiver .....	46
3.1.1	Wi-Fi Communications .....	47
3.1.2	USB Communications .....	47
3.1.3	Serial Port Communications .....	48
3.1.4	Ethernet Communications .....	50
3.1.5	ICOM Communications .....	50
3.1.6	CAN Bus Communications .....	51
3.2	Getting Started .....	51
3.2.1	Communicating with the Receiver .....	51
3.3	Transmitting and Receiving Corrections .....	52
3.3.1	Defining Antenna and Base Antenna .....	54
3.3.2	Base Station Configuration .....	54
3.3.3	Rover Station Configuration .....	55
3.3.4	Configuration Notes .....	56
3.4	ALIGN Heading Master and Remote Configurations .....	57
3.4.1	Automatic Set Up for Direct-Wire Connection between Master and Rover via COM2 .....	57
3.4.2	Manual Set Up via COM2 .....	57
3.5	GLIDE .....	58
3.5.1	Dual-Frequency GLIDE .....	58
3.5.2	PDP and GLIDE Configurations .....	58
3.6	STEADYLINE .....	59
3.6.1	Maintain .....	59
3.6.2	Transition .....	59
3.6.3	Prefer Accuracy .....	60
3.6.4	UAL .....	60
3.7	Enabling SBAS Positioning .....	62
3.8	Enabling PPP .....	62
3.8.1	TerraStar Subscriptions .....	62
3.8.2	Veripos Subscriptions .....	64
3.9	RTK ASSIST .....	64
3.10	Transferring Time Between Receivers .....	65
3.10.1	GPS to Receiver Time Synchronization .....	65
3.10.2	Time Definitions .....	65
3.10.3	Procedures to Transfer Time .....	66
3.11	Interference Toolkit .....	70
3.11.1	Monitoring GNSS Signals .....	70
3.11.2	Disable/Enable Detection .....	72
3.11.3	Monitoring Signals Using a Command Line .....	72
3.11.4	Monitoring Signals Using NovAtel Connect .....	73
3.11.5	Remove Interference Signals .....	74
3.12	Logging and Retrieving Data Overview .....	77

3.12.1	Pass-Through Logging .....	77
3.12.2	Saving Logs to a File .....	78
3.12.3	Logging to Internal Memory .....	79
3.12.4	Logging Using the Log Button .....	80
3.12.5	Transferring Files from Internal Memory to a USB Stick .....	81
3.12.6	Access Internal Memory with a Computer .....	83
3.13	Additional Features and Information .....	84
3.13.1	Strobes .....	84

## **Chapter 4 Built-In Status Tests**

4.1	Receiver Status Word .....	85
4.2	RXSTATUSEVENT Log .....	85
4.3	RXSTATUS Log .....	86
4.3.1	Status Word .....	86
4.3.2	Error Word .....	86
4.3.3	Status Code Arrays .....	87
4.3.4	Receiver Status Code .....	88
4.3.5	Auxiliary Status Codes .....	88
4.3.6	Set and Clear Mask for all Status Code Arrays .....	88

## **Chapter 5 Ethernet Configuration**

5.1	Required Hardware .....	89
5.2	Static IP Address Configuration .....	89
5.2.1	Static IP Address Configuration—Receiver .....	90
5.2.2	Static IP Address Configuration—Windows 7 .....	91
5.2.3	Confirming Ethernet Setup .....	92
5.3	Dynamic IP Address Configuration .....	92
5.4	Base/Rover Configuration through Ethernet Connectivity .....	93
5.5	Large Ethernet Port Data Throughput .....	95

## **Chapter 6 NTRIP Configuration**

6.1	NTRIP Configuration Over Ethernet .....	96
6.2	NTRIP Configuration Over Wi-Fi .....	97

## **Chapter 7 PwrPak7 Wi-Fi Configuration**

7.1	Enable the Wi-Fi Access Point .....	99
7.2	Disable Wi-Fi .....	100
7.3	Change the Wi-Fi PassKey .....	100
7.4	Change the Wi-Fi Channel .....	100
7.5	Change the Wi-Fi IP Address .....	101

---

## Chapter 8 CAN Bus

8.1	Default Configuration .....	103
8.2	Configuring the CAN Bus .....	103
8.2.1	Configuration Notes .....	103
8.2.2	Example of Enabling the CAN Bus .....	104
8.2.3	Example of Modifying the CAN Bus Parameters .....	104
8.2.4	Example of Detecting an Address Claim Failure and Reconfiguring .....	104
8.2.5	Address Claim Procedure .....	105
8.3	NMEA2000 Logging .....	105
8.3.1	Example of NMEA2000 Log Configuration .....	106
8.4	Corrections Over CAN .....	106
8.4.1	Example for Receiving Corrections from Any Source .....	106
8.4.2	Example for Transmitting Corrections to 0x1C Node .....	106
8.5	NovAtel Messages Over CAN .....	106
8.6	Configuring OEM7 Receivers to Use OEM6 CAN Settings .....	107
8.6.1	Configuration on OEM6 .....	107
8.6.2	Configuration on OEM7 .....	107

## Chapter 9 Troubleshooting

9.1	Examining the RXSTATUS Log .....	110
9.2	Examining the AUX1 Status Word .....	113
9.3	High Temperature Environments .....	114
9.3.1	Indicators of an Error State .....	114
9.3.2	Recovering from a Temperature Status Error .....	115
9.3.3	Mitigating High Receiver Temperature .....	115
9.3.4	Monitoring the Receiver Temperature .....	115
9.4	Safe Mode .....	116
9.4.1	Reset Loop Detection .....	116
9.4.2	Recovery Steps .....	117

## Chapter 10 NovAtel Firmware and Software

10.1	Firmware Updates and Model Upgrades .....	118
10.1.1	Firmware Updates .....	118
10.1.2	Model Upgrades .....	118
10.2	Authorization Code .....	119
10.3	Downloading Firmware Files .....	120
10.3.1	Format of Firmware Files .....	120
10.4	Updating or Upgrading Using the WinLoad Utility .....	120
10.4.1	Using the WinLoad Utility .....	120
10.5	Updating the Firmware Using NovAtel Connect .....	122
10.6	Updating the Firmware Using NovAtel Web UI .....	123
10.7	Updating Using SoftLoad Commands .....	124

---

10.7.1	SoftLoad Commands and Logs .....	124
10.7.2	Working With S-Records .....	124
10.7.3	Sending Firmware Data .....	125
10.7.4	SoftLoad Update Method .....	126
10.7.5	SoftLoad Errors .....	128
10.8	Upgrading Using an Auth-Code .....	129
10.8.1	Entering an Auth-Code Using NovAtel Connect .....	129
10.8.2	Entering an Auth-Code Using NovAtel Web UI .....	129
10.8.3	Entering an Auth-Code Using the Command Line .....	129
10.9	Update the Web UI .....	130
10.9.1	Update the Web UI Content Using NovAtel Connect .....	130
10.9.2	Update the Web UI Content Using Web UI .....	131

## **APPENDIX A PwrPak7 Technical Specifications**

A.1	PwrPak7 Performance Specifications .....	133
A.2	PwrPak7D Performance Specifications .....	135
A.1	PwrPak7 IMU Specifications .....	138
A.3	PwrPak7 Mechanical Specifications .....	139
A.4	PwrPak7 Electrical and Environmental Specifications .....	141
A.5	PwrPak7 Data Communication Specifications .....	143
A.6	PwrPak7 Strobe Specifications .....	145
A.7	PwrPak7 Connectors .....	146
A.8	PwrPak7 Power Cable .....	149
A.9	PwrPak7 All I/O SPAN Cable .....	150
A.10	PwrPak7 All I/O Extension Cable .....	153
A.11	PwrPak7 All I/O Cable .....	155
A.12	PwrPak7 COM1 Cable .....	158
A.13	PwrPak7 IMU Cable .....	159

## **APPENDIX B Accessories and Replacement Parts**

B.1	USB Devices Supported .....	161
B.1.1	Restrictions on connecting mass storage devices .....	162

## **APPENDIX C Importance of Antenna Selection**

# Figures

Figure 1: PwrPak7 / PwrPak7-E1 Enclosure .....	23
Figure 2: PwrPak7D / PwrPak7D-E1 Enclosure .....	23
Figure 3: PwrPak7 and PwrPak7-E1 Connectors .....	24
Figure 4: PwrPak7D and PwrPak7D-E1 Connectors .....	24
Figure 5: PwrPak7 Status Indicators .....	26
Figure 6: PwrPak7 and PwrPak7-E1 Installation Example .....	34
Figure 7: PwrPak7D and PwrPak7D-E1 Installation Example .....	35
Figure 8: Fuse for PwrPak7 Power Supply .....	42
Figure 9: Dedicated Battery for PwrPak7 .....	43
Figure 10: Seamless Battery Swap .....	43
Figure 11: Basic Receiver Enclosure Connection Interfaces (example) .....	46
Figure 12: Basic Differential Setup .....	53
Figure 13: Positioning Change Without STEADYLINE .....	59
Figure 14: STEADYLINE Maintain .....	59
Figure 15: STEADYLINE Transition .....	60
Figure 16: STEADYLINE Prefer Accuracy .....	60
Figure 17: STEADYLINE UAL- Warning Limit Example .....	61
Figure 18: STEADYLINE UAL - Out of Bounds Example .....	61
Figure 19: Transfer COARSE Time from Fine Clock to Cold Clock Receiver .....	67
Figure 20: Transfer FINE Time from Fine Clock to Cold Clock Receiver .....	68
Figure 21: Transfer FINE Time from Fine Clock to Warm Clock Receiver .....	69
Figure 22: 1 PPS Alignment .....	69
Figure 23: Location of Receiver Status Word .....	86
Figure 24: Reading the Bits in the Receiver Status Word .....	86
Figure 25: Location of Receiver Error Word .....	87
Figure 26: Reading the Bits in the Receiver Error Word .....	87
Figure 27: Status Code Arrays .....	88
Figure 28: Cross-Over Ethernet Cable Configuration—OEM7 Receiver .....	90
Figure 29: Dynamic IP Address Configuration through a DHCP Server—OEM7 Receiver .....	92
Figure 30: Base/Rover Ethernet Setup—OEM7 Receiver .....	94
Figure 31: NTRIP System .....	96
Figure 32: WinLoad’s Open Window .....	121



Figure 33: Open File in WinLoad ..... 121

Figure 34: COM Port Setup ..... 122

Figure 35: PwrPak7 Dimensions ..... 139

Figure 36: PwrPak7-E1 Center of Navigation ..... 140

Figure 37: PwrPak7 Power Cable ..... 149

Figure 38: PwrPak7 All I/O SPAN Cable ..... 150

Figure 39: PwrPak7 All I/O Extension Cable ..... 153

Figure 40: PwrPak7 All I/O Cable ..... 155

Figure 41: PwrPak7 COM1 Cable ..... 158

Figure 42: PwrPak7 IMU Cable ..... 159

Figure 43: Plot of Good and Poor Antenna Phase Center Variation over Elevation Angle 0-90° ..... 164

# Tables

Table 1: PwrPak7 Connectors .....	24
Table 2: PwrPak7 Status Indicators .....	26
Table 3: PWR (Power) LED .....	26
Table 4: GNSS LED .....	26
Table 5: INS LED .....	27
Table 6: TRANSFER LED .....	27
Table 7: LOG (Onboard Storage) LED .....	28
Table 8: PwrPak7 Cables .....	30
Table 9: PwrPak7 Serial Port Protocol .....	39
Table 10: Fuse/Holder Recommendations 12 V System .....	42
Table 11: Serial Ports Supported .....	49
Table 12: Wi-Fi Default Configuration .....	99
Table 13: Default NAME .....	103
Table 14: Troubleshooting Based on Symptoms .....	109
Table 15: Resolving a Receiver Error Word .....	111
Table 16: Resolving an Error in the Receiver Status Word .....	112
Table 17: Resolving an Error in the AUX1 Status Word .....	113
Table 18: PwrPak7 Physical Description .....	132
Table 19: PwrPak7 Receiver Performance .....	133
Table 20: PwrPak7D Receiver Performance .....	135
Table 21: PwrPak7-E1 and PwrPak7D-E1 IMU Performance .....	138
Table 22: PwrPak7 Environmental Specifications .....	141
Table 23: PwrPak7 Power Requirements .....	141
Table 24: PwrPak7 RF Input/LNA Power Output .....	141
Table 25: PwrPak7 Wheel Sensor Input Signal Levels .....	142
Table 26: Data Communications Interfaces .....	143
Table 27: PwrPak7 Strobes Description .....	145
Table 28: PwrPak7 Strobe Electrical Specifications .....	145
Table 29: PwrPak7 Connectors .....	146
Table 30: 26 Pin D-SUB High Density Pin Out .....	147
Table 31: PwrPak7 Power Cable Pinout .....	149
Table 32: Commercial Power Cable .....	149

Table 33: PwrPak7 All I/O SPAN Cable Pinout .....150

Table 34: PwrPak7 All I/O Extension Cable Pinout ..... 153

Table 35: PwrPak7 All I/O Cable Pinout .....155

Table 36: PwrPak7 COM1 Cable Pinout .....158

Table 37: PwrPak7 IMU Cable Pinout ..... 159

Table 38: OEM7 Receivers .....160

Table 39: GNSS Antennas ..... 160

Table 40: PwrPak7 Cables .....161

Table 41: GNSS Antenna Cables .....161

Table 42: Targeted Peripheral List for OEM7 USB Embedded Host .....162

Table 43: Devices Tested for OEM7 USB Embedded Host ..... 162

# PwrPak7 Notices

The following notices apply to the PwrPak7 device.



Changes or modifications to this equipment, not expressly approved by NovAtel Inc., could void the user's authority to operate this equipment.

## FCC

This device complies with part 15 of the FCC Rules. Operation is subject to the following two conditions: (1) this device may not cause harmful interference, and (2) this device must accept any interference received, including interference that may cause undesired operation.

PwrPak7 has been tested and found to comply with the radiated and conducted emission limits for a Class B digital device. The Class B limits are designed to provide reasonable protection against harmful interference in a residential installation.

The equipment listed generates, uses and can radiate radio frequency energy and, if not installed and used in accordance with the instructions, may cause harmful interference to radio communications. However, there is no guarantee that interference will not occur in a particular installation. If this equipment does cause harmful interference to radio or television reception, which can be determined by turning the equipment off and on, the user is encouraged to try to correct the interference by one or more of the following measures:

- Re-orient or relocate the PwrPak7
- Increase the separation between the equipment and the PwrPak7
- Connect the equipment to an outlet on a circuit different from that to which the PwrPak7 is connected
- Consult the dealer or an experienced radio/TV technician for help



To maintain compliance with the limits of a Class B digital device, you must use shielded interface cables.



The PwrPak7 has been authorized for use in Mobile applications. At least 20 cm (8 inches) of separation between the PwrPak7 and the User must be maintained at all times.

## Wi-Fi

PwrPak7 contains a Wi-Fi radio with the following approvals:

- FCC ID: UTU-01019715

## Innovation, Science and Economic Development (ISED) Canada

PwrPak7 Class B digital device complies with Canadian ICES-003.

PwrPak7 appareil numérique de la classe B est conforme à la norme NMB-003 du Canada.

This device complies with ISED license-exempt RSS-GEN and RSS-247. Operation is subject to the following two conditions: (1) this device may not cause interference and (2) this device must accept any interference, including interference that may cause undesired operation of the device.

Cet appareil est conforme à la norme ISED RSS-GEN et RSS-247. Son fonctionnement est soumis aux deux conditions suivantes: (1) cet appareil ne doit pas provoquer d'interférences et (2) cet appareil doit accepter toute interférence, y compris les interférences pouvant entraîner un fonctionnement indésirable de l'appareil.



The PwrPak7 has been authorized for use in Mobile applications. At least 20 cm (8 inches) of separation between the PwrPak7 and the User must be maintained at all times.

Le PwrPak7 a été autorisé pour une utilisation dans les applications mobiles. Au moins 20 cm (8 pouces) de séparation entre le PwrPak7 et l'utilisateur doit être maintenue à tous fois.

## **Wi-Fi**

PwrPak7 contains a Wi-Fi radio with the following approvals:

- IC: 129A-01019715

## **European Union (EU)**

### ***PwrPak7 Wi-Fi***

NovAtel Inc. declares that the PwrPak7 Wi-Fi transceiver is in compliance with Directive 2014/53/EU (Radio Equipment).

The full text of the EU Declaration of Conformity may be obtained from the NovAtel web site at:

[www.novatel.com/products/compliance/eu-declaration-of-conformity](http://www.novatel.com/products/compliance/eu-declaration-of-conformity)

### ***Radio Information***

Description of Service: Wi-Fi (802.11b/g/n)

Operational Frequency: 2400 MHz to 2480 MHz

Modulation: OFDM

Rated Power: 17.5 dBm e.i.r.p

Operating Frequency Stability: +/- 0.001%

Operating Temperature Range: -40°C to +75°C

Emission Designator: 12M4G1D, 17M5G1D, 18M1G1D


Spurious Emissions: -36 dBm / -54 dBm

The full text of the EU Declaration of Conformity may be obtained from the NovAtel web site at:

[www.novatel.com/products/compliance/eu-declaration-of-conformity](http://www.novatel.com/products/compliance/eu-declaration-of-conformity)

## **WEEE Notice**

If you purchased your PwrPak7 product in Europe, please return it to your dealer or supplier at the end of its life. The objectives of the European Community's environment policy are, in particular, to preserve, protect and improve the quality of the environment, protect human health and utilise natural resources prudently and rationally. Sustainable development advocates the reduction of wasteful consumption of natural resources and the prevention of pollution. Waste electrical and electronic equipment (WEEE) is a regulated area. Where the generation of waste cannot be avoided, it should be reused or recovered for its material or energy. WEEE products

may be recognized by their wheeled bin label () .

See [www.novatel.com/products/compliance/environmental-compliance](http://www.novatel.com/products/compliance/environmental-compliance) for more information.

## **RoHS**

The PwrPak7 is in conformity with Directive 2011/65/EU of the European Parliament and of the council of 8 June 2011 on the restriction of the use of certain hazardous substances in electrical and electronic equipment.

## **REACH**

The PwrPak7 is compliant with Regulation (EC) No. 1907/2006 of the European Parliament and the Council of 18 December 2006 concerning the Registration, Evaluation, Authorization and Restriction of Chemicals (REACH). The candidate list of Substances of Very High Concern (SVHC) published by the European Chemical Agency (ECHA) is available at: <https://echa.europa.eu/candidate-list-table>

## PwrPak7 International Type Approval

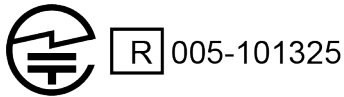
### *Israel*

א. מספר האישור האלחוטי של משרד התקשורת הוא 51-67195.  
ב. אסור להחליף את האנטנה המקורית של המכשיר, וגם לא לבצע בו שינויים טכניים אחרים.

### *Japan*

#### **Wi-Fi**

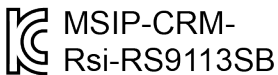
PwrPak7 contains a Wi-Fi radio with the following approvals:



### *Korea*

#### **Wi-Fi**

PwrPak7 contains a Wi-Fi radio with the following approvals:



### *Mexico*

La operación de este equipo está sujeta a las siguientes dos condiciones: (1) es posible que este equipo o dispositivo no cause interferencia perjudicial y (2) este equipo o dispositivo debe aceptar cualquier interferencia, incluyendo la que pueda causar su operación no deseada



Número de modelo: RS-9113-N00-S0C

Número de IFT: RCPNORS19-0120

***UAE***

TRA  
REGISTERED No:

ER68196/18

DEALER No:

DA78636/18

***Ukraine***





## Lightning Protection Installation and Grounding Procedure

### ***What is the hazard?***

A lightning strike into the ground causes an increase in the earth's potential which results in a high voltage potential between the center conductor and shield of the coaxial cable. This high voltage develops because the voltage surge induced onto the center conductor lags in time behind the voltage surge induced onto the shield.

### ***Hazard Impact***

A lightning strike causes the ground potential in the area to rise to dangerous levels resulting in harm to personnel or destruction of electronic equipment in an unprotected environment. It also conducts a portion of the strike energy down the inner conductor of the coaxial cable to the connected equipment.



Only qualified personnel, such as electricians mandated by the governing body in the country of installation, may install lightning protection devices.

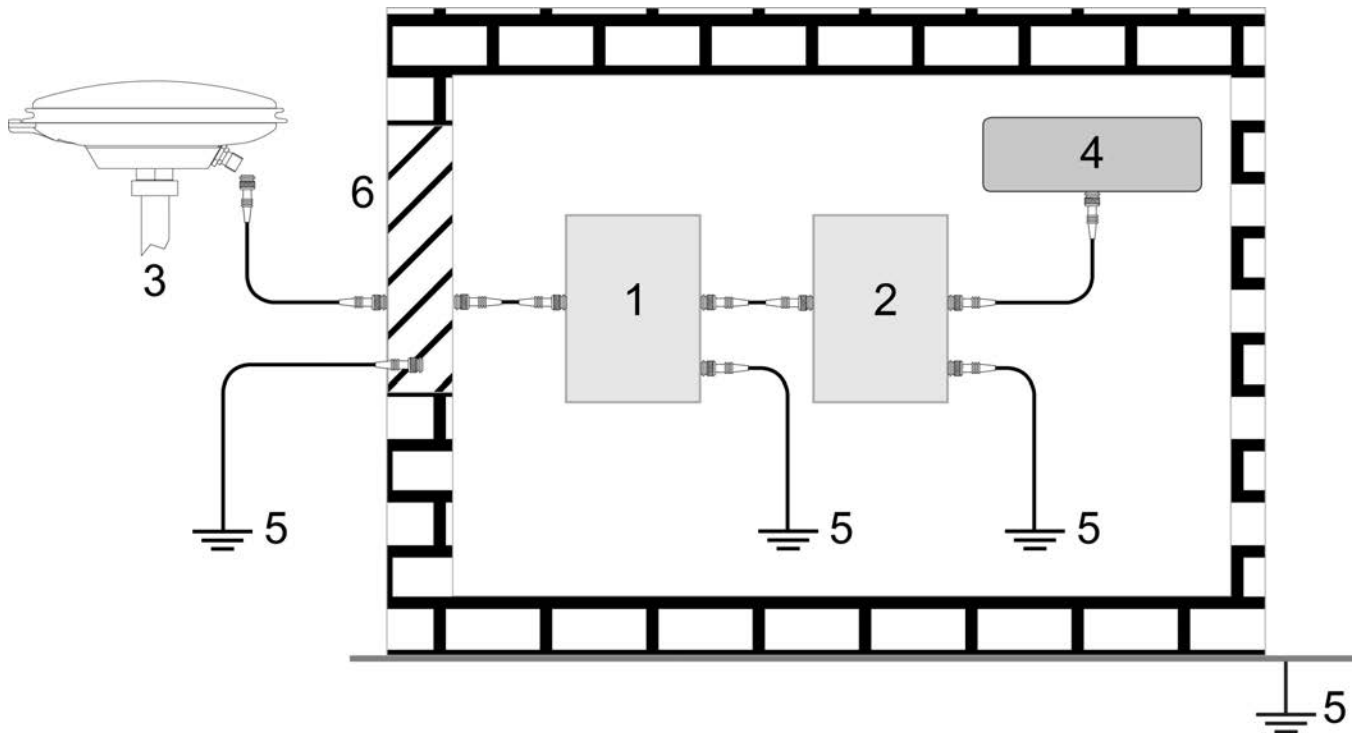
### ***Actions to Mitigate Lightning Hazards***

1. Do not install antennas or antenna coaxial cables outside the building during a lightning storm.
2. It is not possible to avoid over voltages caused by lightning, but a lightning protection device may be used to shunt a large portion of the transient energy to the building ground, reducing the over voltage condition as quickly as possible.
3. Primary lightning protection must be provided by the operator/customer according to local building codes as part of the extra building installation.
4. To ensure safe operation, a secondary lightning protection device must be used for in-building equipment installations with external antennas. The following device has been approved by NovAtel Inc.:

Polyphaser - Surge Arrestor DGXZ+36NFNF-A

If this device is not chosen as the primary lightning protection device, the device chosen must:

- Be UL listed (or equivalent) in the country of installation for lightning surge protection
  - The primary device must be capable of limiting an incoming surge to 10 kV
5. The shield of the coaxial cable entering the building should be connected at a grounding plate at the building's entrance. The lightning protection devices should have their chassis grounded to the same ground near to the building's entrance.
  6. The primary and secondary lightning protections should be as close to the building's entrance as possible. Where feasible, mount onto the grounding plate itself (refer to the figure below).



Ref #	Description
1	Primary lightning protection device
2	Secondary lightning protection device
3	External antenna
4	GNSS Receiver
5	To ground
6	Grounding plate or grounding point at the building's entrance



Acceptable choices for earth grounds, for central buildings, are:

- Grounded interior metal cold water pipe within five feet (1.5 m) of the point where it enters the building
- Grounded metallic service raceway
- Grounded electrical service equipment enclosure
- Eight-foot grounding rod driven into the ground (only if bonded to the central building ground by #6, or heavier, bonding wire)

These installation instructions are the minimum requirements for receiver and antenna installations. Where applicable, follow the electrical codes for the country of installation. Examples of country codes include:

- **USA** National Electrical Code (NFPA 70)
- **Canada** Canadian Electrical Code (CSA C22.1)
- **UK** British Standard (BS7671)

## **Ethernet Port**



The Ethernet port is a safety extra-low voltage (SELV) circuit only and is suitable for connection within a building only. Do not connect them to Telecommunications Network Voltage (TNV) circuits.

## **Conventions**

The following conventions are used in this manual:



Information that supplements or clarifies text.



A caution that actions, operation or configuration may lead to incorrect or improper use of the hardware.



A warning that actions, operation or configuration may result in regulatory non-compliance, safety issues or equipment damage.

# Customer Support

## NovAtel Knowledge Base

If you have a technical issue, visit the NovAtel Support page at [www.novatel.com/support](http://www.novatel.com/support). Through the *Support* page, you can contact Customer Support, find papers and tutorials or download current manuals and the latest firmware.

## Before Contacting Customer Support

Before contacting NovAtel Customer Support about a software problem, perform the following steps:



If logging data over an RS-232 serial cable, ensure that the configured baud rate can support the data bandwidth (see **SERIALCONFIG** command). NovAtel recommends a minimum suggested baud rate of 230400 bps.

1. Log the following data to a file on your computer for 15 minutes:

```
RXSTATUSB onchanged
RAWEPHEMB onchanged
GLORAWEPHEMB onchanged
BESTPOSB ontime 1
RANGEB ontime 1
RXCONFIGA once
VERSIONA once
PORTSTATS ontime 10
```

For SPAN systems, add the following logs to the above list in the file created on your computer:

```
RAWIMUSXB onnew
INSUPDATESTATUSB onnew
INSPVAXB ontime 1
INSCONFIGA onchanged
```

2. Send the data file to NovAtel Customer Support: [support@novatel.com](mailto:support@novatel.com)
3. You can also issue a **FRESET** command to the receiver to clear any unknown settings.



The **FRESET** command will erase all user settings. You should know your configuration (by requesting the RXCONFIGA log) and be able to reconfigure the receiver before you send the **FRESET** command.

If you are having a hardware problem, send a list of the troubleshooting steps taken and the results.

## Contact Information

Log a support request with NovAtel Customer Support using one of the following methods:

**Log a Case and Search Knowledge:**

Website: [www.novatel.com/support](http://www.novatel.com/support)

**Log a Case, Search Knowledge and View Your Case History:** (login access required)

Web Portal: <https://novatelsupport.force.com/community/login>

**E-mail:**

[support@novatel.com](mailto:support@novatel.com)

**Telephone:**

U.S. and Canada: 1-800-NOVATEL (1-800-668-2835)

International: +1-403-295-4900

# Chapter 1 PwrPak7 Overview

NovAtel's PwrPak7 is a scalable, high precision GNSS receiver in a lightweight, compact, environmentally protective enclosure. There are several hardware versions of the PwrPak7 to meet a range of GNSS applications.

- **PwrPak7**

The PwrPak7 uses the OEM7700 receiver card to deliver scalable high precision positioning solution in a compact, lightweight enclosure.

- **PwrPak7D**

The PwrPak7D is a dual antenna enclosure that uses the OEM7720 receiver card to provide a high precision positioning and heading solution.

- **PwrPak7-E1**

The PwrPak7-E1 combines GNSS and INS hardware in a single enclosure to provide an easy to deploy SPAN GNSS+INS system. The PwrPak7-E1 uses an OEM7700 receiver card to deliver scalable high precision positioning and an Epson G320N IMU to deliver accelerometer and gyroscope measurements.

- **PwrPak7D-E1**

The PwrPak7D-E1 combines dual antenna GNSS and INS hardware in a single enclosure to provide an easy to deploy SPAN GNSS+INS and ALIGN system. The PwrPak7D-E1 uses an OEM7720 receiver card to deliver scalable high precision positioning and heading, and an Epson G320N IMU to deliver accelerometer and gyroscope measurements.



In this documentation, the term PwrPak7 is used to represent all hardware versions of the PwrPak7 enclosure (PwrPak7, PwrPak7D, PwrPak7-E1 and PwrPak7D-E1). When a section applies to a specific variant of the PwrPak7 enclosure, the applicable receiver is identified (e.g. PwrPak7-E1 only).

The PwrPak7 provides the following features:

- Multi-frequency/Multi-constellation
- 555 channel operation
- Dual antenna inputs for single enclosure heading solution (PwrPak7D and PwrPak7D-E1 only)
- SPAN GNSS+INS functionality
- Three serial communication ports, 2 RS-232/RS-422 and 1 RS-232
- One USB communication port
- One USB data transfer port
- Ethernet communication port
- Wi-Fi communication interface
- CAN bus port
- Event outputs
- Event inputs

- Pulse Per Second (PPS) output
- Wheel sensor inputs
- PPP, RTK, SBAS and DGPS positioning solutions
- GLIDE and ALIGN positioning options
- Enhanced interference mitigation
- 16 GB of internal memory
- Web User Interface

**Figure 1: PwrPak7 / PwrPak7-E1 Enclosure**



**Figure 2: PwrPak7D / PwrPak7D-E1 Enclosure**

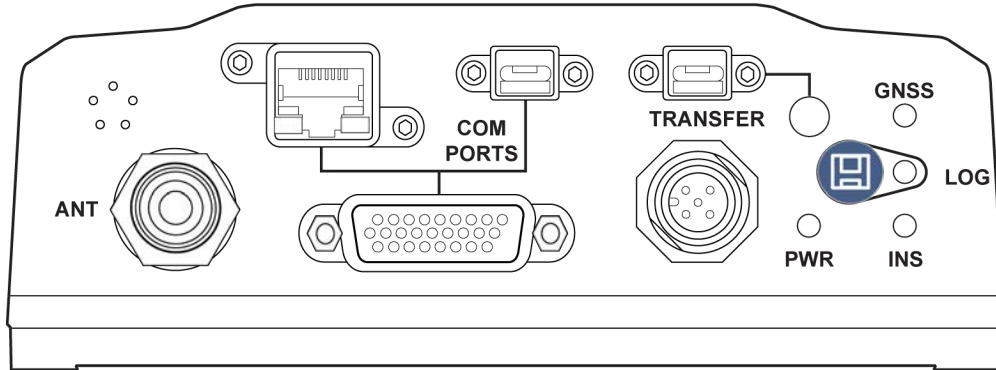


PwrPak7, PwrPak7D, PwrPak7-E1 and PwrPak7D-E1 technical specifications are provided in *PwrPak7 Technical Specifications* on page 132.

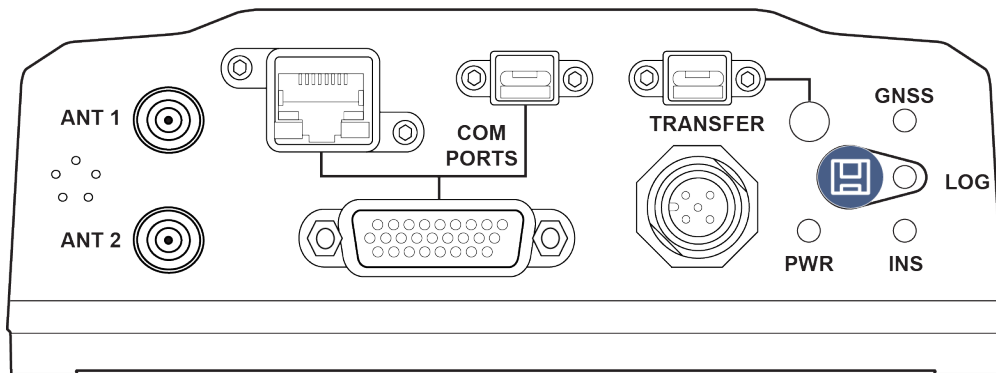
## 1.1 PwrPak7 Connectors

The PwrPak7 has several connectors for connecting the receiver to other components in the GNSS system.



**Figure 3: PwrPak7 and PwrPak7-E1 Connectors**





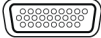


**Figure 4: PwrPak7D and PwrPak7D-E1 Connectors**



**Table 1: PwrPak7 Connectors**

Connector	Label	Connector Type	Description
	ANT	TNC	Connects the receiver to the GNSS antenna (PwrPak7 and PwrPak7-E1)
	ANT 1	SMA	Connects the receiver to the primary GNSS antenna (PwrPak7D and PwrPak7D-E1)
	ANT 2	SMA	Connects the receiver to the secondary GNSS antenna (PwrPak7D and PwrPak7D-E1)

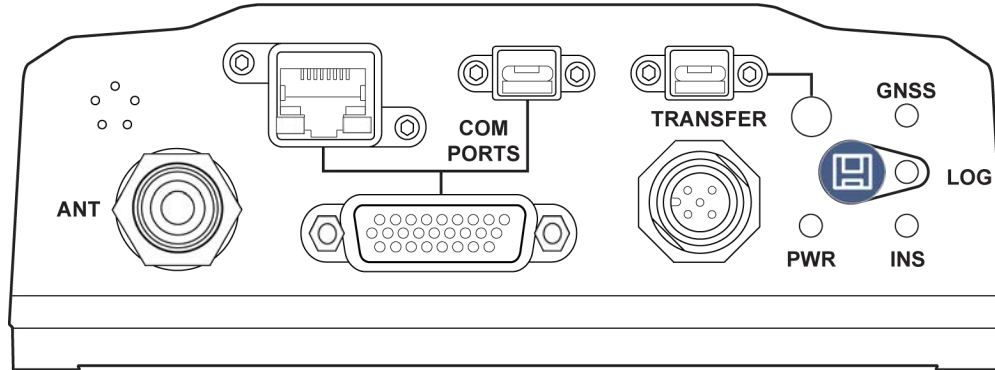


Connector	Label	Connector Type	Description
	COM PORTS	RJ45	Connects the receiver to an Ethernet network Used to communicate to the receiver using a network connection
		USB Micro A/B	A USB 2.0 port used to communicate from a computer to the receiver using a USB cable
		DSUB HD26	Provides access to communication signals on the receiver. This includes: <ul style="list-style-type: none"> <li>• 3 Event inputs (LVCMOS)</li> <li>• 3 Event outputs (LVCMOS)</li> <li>• 1 Pulse Per Second output (LVCMOS)</li> <li>• 1 CAN bus</li> <li>• 3 serial ports <ul style="list-style-type: none"> <li>• COM1 RS-422/RS-232 user selectable</li> <li>• COM2 RS-422/RS-232 user selectable</li> <li>• COM3 RS-232</li> </ul> </li> <li>• Wheel Sensor RS-422 Quadrature Input</li> </ul>
	TRANSFER	USB Micro A/B	USB 2.0 port used to transfer files from the on board memory to a USB stick or computer
	PWR	SAL M12 5 pin	Connects the receiver to the power supply

Refer to the *PwrPak7 Connectors* on page 146 for connector details.

## 1.2 PwrPak7 LEDs

The PwrPak7 has five LEDs to indicate receiver status. It also has a button to start or stop data logging to a file.

**Figure 5: PwrPak7 Status Indicators**

The following tables provide information about the PwrPak7 LEDs and their states.

**Table 2: PwrPak7 Status Indicators**

Label	Description
PWR	Indicates the power status of the receiver
GNSS	Indicates the position status of the receiver
INS	Indicates the INS status of the receiver This LED is applicable only to SPAN capable PwrPak7 models (a PwrPak7-E1 or PwrPak7D-E1, or a PwrPak7 with an external IMU)
TRANSFER	Indicates the status of logging or file-transfer to a USB stick or connection to a computer as a USB Device
LOG	Indicates the status of logging to the receiver internal memory

**Table 3: PWR (Power) LED**

State	Description
Green solid	Operational mode
Yellow solid	In the process of booting
Red solid	Error, for example invalid receiver AUTH code Receiver firmware or Web User Interface update in progress

**Table 4: GNSS LED**

State	Description
Green solid	PPP solution User Accuracy Level (UAL) Operational (STEADYLINE)

<b>State</b>	<b>Description</b>
Green slow blink	RTK integer ambiguity
Green fast blink	Single point or SBAS solution UAL Warning
Yellow solid	No solution UAL Out of Bounds
<b>If the PwrPak7 is configured as a base station</b>	
Green solid	Fixed position
Yellow solid	Pending fixed position
Yellow blink	Invalid fix

**Table 5: INS LED**

<b>State</b>	<b>Description</b>
Off	INS inactive
Green solid	INS solution good
Green slow blink	INS alignment complete
Green fast blink	INS solution free
Green/Yellow alternating blink	High variance
Yellow blink	INS aligning/determining orientation
Red solid	Error

**Table 6: TRANSFER LED**

<b>LED State</b>	<b>Description</b>
Green solid	USB stick plugged in, mounted and idle (lots of available memory) Transfer port connected to a computer
Green slow blink	Logging to USB stick (lots of available memory)
Green fast blink	Transferring files to USB stick (lots of available memory)
Green/Yellow alternating slow blink	Logging to USB stick (low memory)

LED State	Description
Green/Yellow alternating fast blink	Transferring files to USB stick (low memory)
Yellow solid	USB stick plugged in, mounted and idle (low memory)
Yellow fast blink	USB stick mounting/unmounting/busy
Red solid	USB stick plugged in and mounted, but memory full
Red fast blink for 3 seconds	Push button error or USB stick mount error
Off	No connection to the TRANSFER port or the USB stick is unmounted

Table 7: LOG (Onboard Storage) LED

LED State	Description
Off	PwrPak7 is connected to a computer as a mounted device See <i>Access Internal Memory with a Computer</i> on page 83
Green blink	Logging to internal memory (lots of memory available)
Green solid	Internal logging stopped (lots of memory available)
Green/Yellow alternating blink	Logging to internal memory (low memory)
Yellow solid	Internal logging stopped (low memory)
Yellow fast blink	Memory is mounting or unmounting/busy
Red solid	Internal memory full or corrupt Refer to <i>Repair Errors on the Internal Memory</i> on page 83
Red fast blink for 3 seconds	Push button error

### 1.3 Related Documents and Information

After the OEM7 receiver is set up, the [OEM7 Commands and Logs Reference Manual](#) becomes the primary source for command and log information.



Each receiver has a specific set of features, so some commands and logs may not be supported by your model.

For instructions on configuring and using SPAN functionality, refer to the [OEM7 SPAN Installation and Operation User Manual](#).

Refer to our web site [docs.novatel.com/OEM7](https://docs.novatel.com/OEM7) for the latest documentation.

This manual does not cover OEM7 service and repair. Contact a local NovAtel dealer for service or repair inquiries (refer to *Customer Support* on page 20 for contact details).

## Chapter 2 PwrPak7 Installation

This chapter provides instructions to install the PwrPak7 and create a GNSS receiver system.

### 2.1 Shipping Box

The following is provided with the PwrPak7:

- Power cable – M12 connector to bare wires (01019764)
- PwrPak7 COM1 Cable (01019765)
- USB Cable, A Plug to Micro-B Plug with Ferrites (60723175)
- PwrPak7 Quick Start Guide (GM-14915152)

### 2.2 Additional Equipment Required

The following additional equipment is required for the GNSS receiver system:

- A 9-36 VDC, fuse protected power supply capable of at least 15 W
- A quality GNSS antenna, such as NovAtel's VEXXIS® GNSS-500 or GNSS-800 series antennas  
For a list of NovAtel GNSS antennas refer to [www.novatel.com/antennas](http://www.novatel.com/antennas)
- A quality coaxial cable with a TNC male connector at the receiver end (PwrPak7 or PwrPak7-E1)  
Two quality coaxial cables with an SMA male connector at the receiver end (PwrPak7D or PwrPak7D-E1)

The following equipment may also be needed, depending on the system configuration:

- A computer/tablet/smartphone with Wi-Fi and a web browser or a computer with an RS-232 DB-9, Ethernet or USB port
- Shielded Ethernet cable
- Micro A to USB stick adapter, such as Tensility 10-00649 or equivalent
- Four M5 or #10 size screws for mounting



Use a serial COM, USB or Wi-Fi connection to communicate with the receiver first. This provides the ability to configure the computer and PwrPak7 before using Ethernet.



When the PwrPak7 is installed in a permanent location, such as in a building, it should be protected by a lightning protection device according to local building codes. See *Lightning Protection Installation and Grounding Procedure* on page 17.

### 2.3 Optional Accessories

The following optional accessories are available from NovAtel:

- *PwrPak7 IMU Cable* on page 159 (01019767)
- *PwrPak7 All I/O SPAN Cable* on page 150 (01020004)
- *PwrPak7 All I/O Extension Cable* on page 153 (01020005)
- *PwrPak7 All I/O Cable* on page 155 (01019766)
- Optional external SPAN compatible IMU  
See [www.novatel.com/products/span-gnss-inertial-systems/span-imus/](http://www.novatel.com/products/span-gnss-inertial-systems/span-imus/)

## 2.4 PwrPak7 Cables

To prevent damage to both the receiver and the cables, each connector can be inserted in only one way.

Furthermore, the connectors used to mate the cables to the receiver require careful insertion and removal. Observe the following when handling cables.

- To insert a cable, make certain to use the appropriate cable for the PwrPak7 connector
- Insert the connector until it is on straight and secure
- To remove a cable, grasp it by the connector



Do not pull directly on a cable.

**Table 8: PwrPak7 Cables**

NovAtel Part Number	Cable Name	Purpose
01019764	<i>PwrPak7 Power Cable</i> on page 149	Connects the PwrPak7 to an external power supply SAL M12, 5 pin to bare wires
01019765	<i>PwrPak7 COM1 Cable</i> on page 158	Provides connection to the COM1 serial port on the PwrPak7 COM PORTS connector HD26 to DB9
01019766	<i>PwrPak7 All I/O Cable</i> on page 155	Provides connections for all of the signals available on the PwrPak7 COM PORTS connector HD26 to three DB9 connectors and multiple wires
01019767	<i>PwrPak7 IMU Cable</i> on page 159	Provides connection from the COM1 serial port on the PwrPak7 COM PORTS connector to the communications port on an IMU Enclosure HD26 to SAL M12, 5-pin

NovAtel Part Number	Cable Name	Purpose
01020004	<i>PwrPak7 All I/O SPAN Cable</i> on page 150	Provides connections for all of the signals available on the PwrPak7 COM PORTS connector. The COM2 connector on this cable includes additional signals required for connection to some IMUs. HD26 to three DB9 connectors and one DB15 connector
01020005	<i>PwrPak7 All I/O Extension Cable</i> on page 153	This cable is an accessory for the <i>All I/O SPAN Cable</i> (01020004). It breaks out the signals on the 01020004 DB15 connector to individual leads. DB15 to multiple wires
60723175	USB Cable, A Plug to Micro-B Plug with Ferrites	Connects from the PwrPak7 USB COM PORTS connector to a computer

## 2.5 Selecting a GNSS Antenna

NovAtel offers a variety of GNSS antennas, including single, dual and triple-frequency, triple-band and wide-band reference antennas (refer to our web site: [www.novatel.com/antennas](http://www.novatel.com/antennas) for details of available antennas). All antennas include band pass filtering and an LNA. The GNSS antenna chosen depends on the particular application. Each model offers exceptional phase center stability and a significant measure of immunity against multipath interference. Each antenna has an environmentally sealed radome and all meet the European Union's Restriction of Hazardous Substances (RoHS) and Waste Electrical and Electronic Equipment (WEEE).

If a non-NovAtel GNSS antenna is chosen, a typical antenna LNA gain between 26 dB to 30 dB is recommended in a rover station application.



A dual frequency capable GNSS antenna is required to use SPAN, RTK, ALIGN or dual frequency GLIDE.  
An L-Band capable antenna is required to receive TerraStar corrections.

For more information about antenna selection, see *Importance of Antenna Selection* on page 163.

## 2.6 Choosing a Coaxial Cable

An appropriate coaxial cable matches the impedances of the antenna and receiver (50 ohms) and has a line loss not exceeding 10.0 dB. If the limit is exceeded, excessive signal degradation may occur and the receiver may not meet performance specifications. NovAtel offers several coaxial cables to meet GNSS antenna interconnection requirements, including:

- 5 m, 15 m and 30 m antenna cable with TNC connectors on both ends (NovAtel part numbers GPS-C006, GPS-C016 and GPS-C032)

- 2.5 m and 5 m antenna cable with an SMA connector on one end and a TNC connector on the other (NovAtel part numbers 60723177 and 60723178)



The SMA to TNC cables (60723177 and 60723178) are not recommended for permanent outdoor use.



For more information about antenna cabling, including using cables longer than 30 m and in-line amplifiers, refer to APN-077: RF Equipment Selection and Installation available from ([www.novatel.com/assets/Documents/Bulletins/APN-077-RFEquipmentSelection.pdf](http://www.novatel.com/assets/Documents/Bulletins/APN-077-RFEquipmentSelection.pdf)).



NovAtel recommends using high quality coaxial cables because an impedance mismatch is possible when using lower quality cables and this produces reflections in the cable that increases signal loss. Although other high quality antenna cables can be used, the performance specifications of the OEM7 receivers are warranted only when used with NovAtel supplied accessories.

## 2.7 Power Supply Requirements for the PwrPak7

The PwrPak7 requires a power supply that provides:

- a voltage in the range of +9 to +36 VDC
- at least 15 W of power

See *PwrPak7 Electrical and Environmental Specifications* on page 141 for more power supply specifications.

The PwrPak7 has an internal power module that:

- filters and regulates the supply voltage
- protects against over-voltage, over-current and high-temperature conditions
- provides automatic reset circuit protection



If the voltage supplied is below the minimum specification, the receiver suspends operation. If the voltage supplied is above the maximum specification, the receiver may be permanently damaged, voiding the warranty.

The supply must be capable of providing enough current to operate the PwrPak7, including the initial inrush transient. The supply must also be current limited to 6 A with an external fuse.



The amount of power required depends on the number of constellations and signals tracked, and the features enabled.

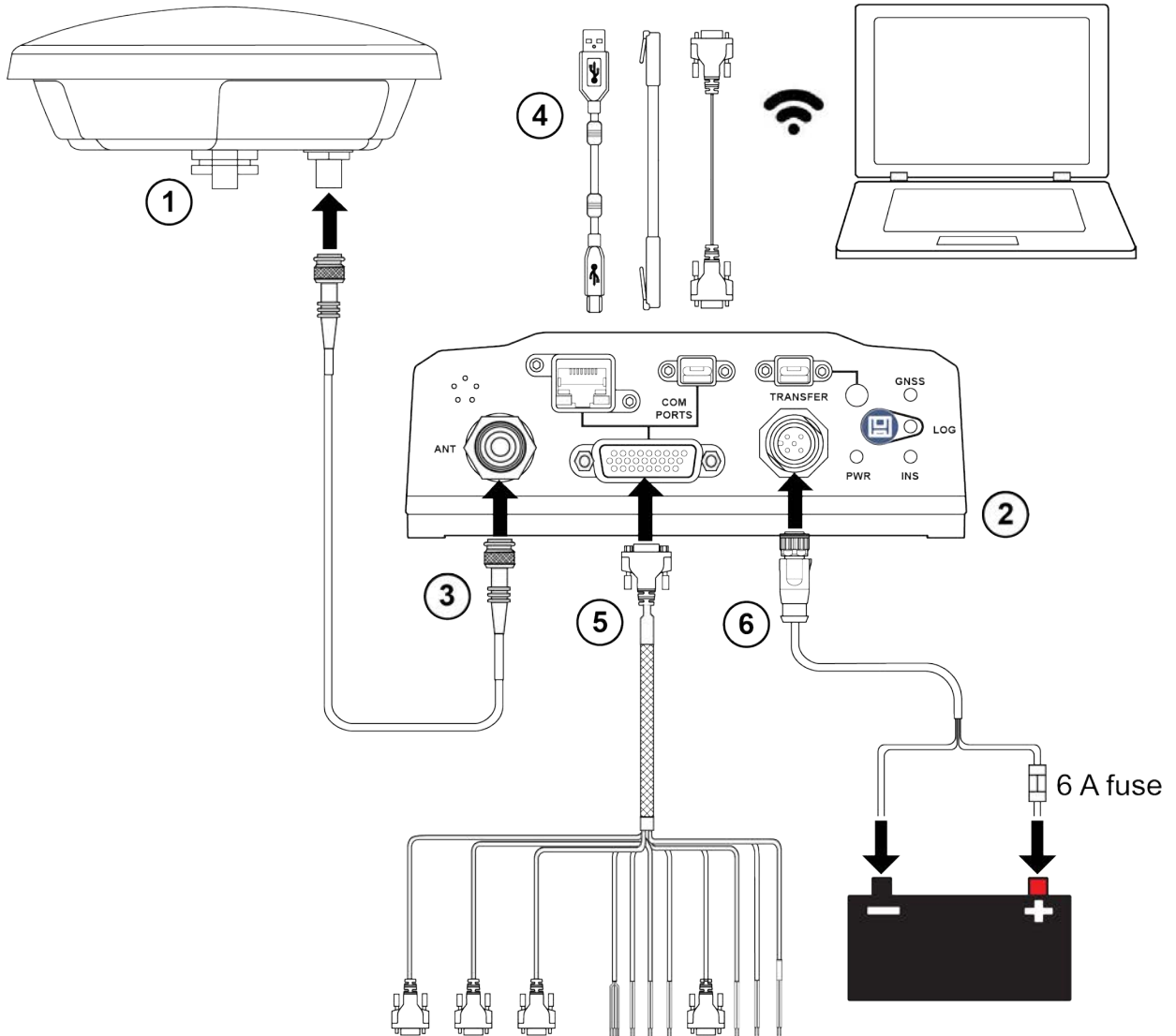


The power cable included with the PwrPak7 has a connector on the receiver end (SAL M12 5 pin) and bare wires on the other end. Refer to *PwrPak7 Power Cable* on page 149 for details about the power cable.

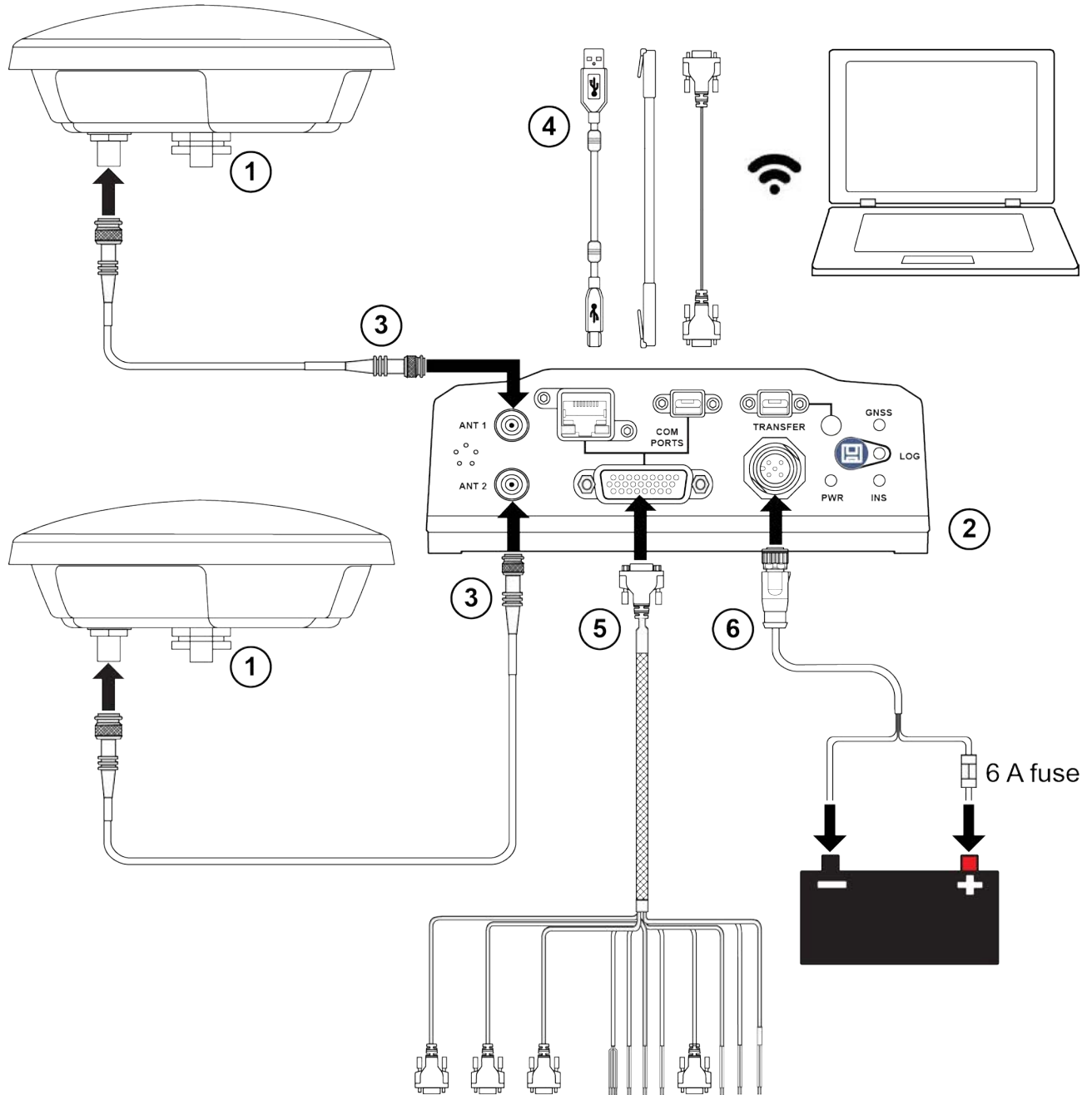
## 2.8 PwrPak7 Installation Overview

When the appropriate equipment is selected, complete the following steps to set up and begin using the NovAtel GNSS receiver.

**Figure 6: PwrPak7 and PwrPak7-E1 Installation Example**



**Figure 7: PwrPak7D and PwrPak7D-E1 Installation Example**



1. Mount the GNSS antenna.  
For a PwrPak7D or PwrPak7D-E1, mount the primary and secondary GNSS antennas. See *Mounting the GNSS Antenna* on the next page for more information.
2. Mount the receiver.  
For a PwrPak7 or PwrPak7D, refer to *Mount the PwrPak7* on page 37.  
For a PwrPak7-E1 or PwrPak7D-E1, refer to *Mount the PwrPak7-E1* on page 37.
3. Connect one end of the antenna cable to the GNSS antenna and the other end of the cable to

the antenna connector (ANT) on the receiver.

For a PwrPak7D or PwrPak7D-E1:

Connect an antenna cable from the primary GNSS antenna to the ANT 1 connector on the receiver.

Connect a second antenna cable from the secondary GNSS antenna to the ANT 2 connector on the receiver.

The PwrPak7 supplies +5 VDC (200 mA maximum) to the antenna LNA through the center conductor of the antenna cable. See *Antenna LNA Power* below for more information.

4. Connect the receiver to other GNSS system components, such as a computer or data terminal, using the communication ports or Wi-Fi.  
See *Connect the PwrPak7 to Data Communication Equipment* on page 38.
5. Connect other GNSS system components using the input and output lines.  
See *Connect I/O Signals to the PwrPak7* on page 41.
6. Connect the supplied power cable to the power port (PWR) on the receiver and then connect the power cable to the power supply.  
Ensure a 6 A slow blow fuse is incorporated in the power wiring.  
See *Connect Power to the PwrPak7* on page 41 and *Power Supply Requirements for the PwrPak7* on page 32 for details.

## 2.9 Mounting the GNSS Antenna

The PwrPak7 is designed to operate with any NovAtel GNSS antenna. See *Selecting a GNSS Antenna* on page 31 for more information.

When installing the antenna:

- Choose an antenna location with a clear view of the sky so each satellite above the horizon can be tracked without obstruction. For more information on RF signal propagation and multipath, refer to the NovAtel application note [APN-008 Discussions on RF Signal Propagation and Multipath](http://www.novatel.com/support/APN-008_Discussions_on_RF_Signal_Propagation_and_Multipath) at [www.novatel.com/support/](http://www.novatel.com/support/).
- Mount the antenna on a secure, stable structure capable of safe operation in the specific environment.
- Ensure the antenna cannot move due to dynamics.
- For dual antenna systems only  
Heading accuracy is dependent on antenna baseline length. Mount the primary and secondary antennas as far apart as possible. A minimum separation distance of 1 metre is recommended.

### 2.9.1 Antenna LNA Power

NovAtel antennas and coaxial cables meet receiver RF input gain requirements. NovAtel coaxial cables are designed to introduce no more than 10 dB loss and NovAtel antennas are equipped with built-in LNAs that provide 29 dB of gain to the satellite signal received.

The power to the antenna LNA is provided through the receiver's RF port center conductor.

OEM7 receivers, except the OEM7600, provide +5 VDC  $\pm 5\%$  at a maximum of 200 mA. The OEM7600 provides +3.3 VDC  $\pm 5\%$  at a maximum of 100 mA.

Antenna supply over current protection limits the LNA power.



If a short circuit or other problem causes an overload of the current supplied to the antenna, the receiver hardware shuts down the power supplied to the antenna. To restore power, power cycle the receiver. The Receiver Status word, available in the **RXSTATUS** log (see [OEM7 Commands and Logs Reference Manual](#)), provides more information about the cause of the problem.

## 2.10 Mount the PwrPak7

Mount the PwrPak7 on a secure, stable surface using four M5 or #10 size screws fastened through the PwrPak7 mounting holes. The torque of the screws should not exceed 15 inch-lb.

See *PwrPak7 Mechanical Specifications* on page 139 for drawings of the PwrPak7 dimensions and locations of the mounting holes.



### Wi-Fi Interface

The Wi-Fi interface SSID and default security key are printed on a label on the bottom of the PwrPak7. If you intend to use the Wi-Fi interface and NovAtel Web User Interface, record the SSID and default security key before securing the PwrPak7 in its mounting location.



The PwrPak7-E1 and PwrPak7D-E1 have additional mounting considerations, refer to *Mount the PwrPak7-E1* below for more information

## 2.11 Mount the PwrPak7-E1



This section applies to all PwrPak7 enclosures with an integrated IMU (i.e. PwrPak7-E1 and PwrPak7D-E1). Anywhere PwrPak7-E1 is used in this section, it is referring to any of these receivers.

Mount the PwrPak7-E1 in a fixed location where the distance from the receiver to the GNSS antenna phase center is constant. Ensure that the orientation with respect to the vehicle and antenna is also constant. Secure the PwrPak7-E1 using four M5 or #10 size screws fastened through the PwrPak7-E1 mounting holes. The torque rate of the screw should not exceed 15 inch-lb. See *PwrPak7 Mechanical Specifications* on page 139 for drawings of the PwrPak7-E1 dimensions and locations of the mounting holes.

For attitude output to be meaningful, the PwrPak7-E1 should be mounted such that the positive Z-axis marked on the receiver points up and the Y-axis points forward through the front of the vehicle, in the direction of track. If the PwrPak7-E1 is not mounted in this orientation, a rotational offset must be applied. See the [OEM7 SPAN Installation and Operation User Manual](#) for more information.

Also, it is important to measure the distance from the PwrPak7-E1 center of navigation to the antenna phase center (the Antenna Lever Arm) on the axis defined on the PwrPak7-E1. For the PwrPak7D-E1, the lever arm to both the primary and secondary antenna must be measured. See

the [OEM7 SPAN Installation and Operation User Manual](#). See also *PwrPak7 Mechanical Specifications* on page 139 for the center of navigation location.



The enclosure axis labels are approximately located at the center of navigation. For precise offsets from the enclosure reference point to the IMU center of navigation, use the information located on the label on the bottom of the enclosure.

Ensure the PwrPak7-E1 cannot move due to dynamics and that the distance and relative direction between the antenna and the PwrPak7-E1 is fixed.



The closer the antenna is to the PwrPak7-E1, particularly in the horizontal plane, the more accurate the position solution. Also, the measurements entered using the **SETINSTRANSLATION** command must be as accurate as possible, or at least more accurate than the GNSS positions being used. For example, a 10 cm error in recording the antenna offset will result in at least a 10 cm error in the output. Millimeter accuracy is preferred.

The offset from the PwrPak7-E1 to the antenna, and/or a user point device, must remain constant especially for RTK or DGNSS data. Ensure the PwrPak7-E1, antenna and user point device are bolted in one position perhaps by using a custom bracket.



### **Wi-Fi Interface**

The Wi-Fi interface SSID and default security key are printed on a label on the bottom of the PwrPak7-E1. If you intend to use the Wi-Fi interface and NovAtel Web User Interface, record the SSID and default security key before securing the PwrPak7-E1 in its mounting location.

## **2.12 Connect the PwrPak7 to Data Communication Equipment**

The PwrPak7 can communicate with other devices in the system, such as computers and data loggers, using serial, USB, Wi-Fi or Ethernet ports.

- *Serial Ports* below
- *USB Ports* on the next page
- *Wi-Fi* on the next page
- *Ethernet Port* on page 40
- *CAN Bus Port* on page 40

### **2.12.1 Serial Ports**

The PwrPak7 has three serial ports: COM1, COM2 and COM3. These ports are available on the HD26 COM PORTS connector. Refer to *PwrPak7 Connectors* on page 146 for the pin out of this connector.

**Table 9: PwrPak7 Serial Port Protocol**

Port	RS-232	RS-422	Flow Control
COM1	Yes	Yes	RTS/CTS
COM2	Yes	Yes	No
COM3	Yes	No	No

COM1 and COM2 can operate using RS-232 protocol or RS-422 protocol. To change the serial port protocol, use the **SERIALPROTOCOL** command.

COM1 can operate using hardware flow control when the protocol is set to RS-232. To enable or disable, hardware flow control (handshaking), use the **SERIALCONFIG** command.

Port settings (bit rate and parity, for example) are software configurable. See *Communications with the Receiver* on page 46 for information about configuring the serial ports. Also see *PwrPak7 Data Communication Specifications* on page 143 for the serial port specifications.

To connect to a serial port:

1. Connect the PwrPak7 All I/O SPAN cable (PN: 01020004), or a custom made cable, to the HD26 COM PORTS connector.

For information about the PwrPak7 All I/O SPAN cable, see *PwrPak7 All I/O SPAN Cable* on page 150. This section also has the connector pin out and connector recommendations for making a custom cable.

2. Connect the appropriate DB9 connector (COM1, COM2 or COM3) to the serial port on the computer or other data communication device.

### 2.12.2 USB Ports

The PwrPak7 has two USB 2.0 compatible ports. However, only the one labeled **COM PORTS** can be used for communicating with other devices. The **TRANSFER** USB port is used for downloading files from the PwrPak7 onboard memory.

The USB ports operate at 480 Mb/s.

To connect to the USB port:

1. Connect the micro USB connector of the supplied USB cable to the COM PORTS USB port on the PwrPak7.
2. Connect the other end of the supplied USB cable to the computer or other data communication device.

### 2.12.3 Wi-Fi

The PwrPak7 has a Wi-Fi Access Point that is enabled by default. This provides for easy connection to any laptop/tablet/smartphone with Wi-Fi capability and a web browser.

1. Once the receiver is installed and powered, use a Wi-Fi capable laptop/tablet/smartphone to locate the PwrPak7 in the list of detected Wi-Fi Networks and establish a connection.

The PwrPak7 SSID is printed on a label on the bottom of the receiver. The format of the SSID is *PwrPak7-<Receiver PSN>*, e.g. "PwrPak7-ABCDEF1234567".

2. When first connecting via Wi-Fi, the security key must be entered. The default security key is printed on a label on the bottom of the PwrPak7. The default security key is specific to that PwrPak7 receiver.



*Windows users:* Note the PwrPak7 Wi-Fi security key is not a PIN. If you see an option such as *Connect using a security key instead*, you must click this option to enter your security key.

3. Open up a web browser and enter any web address (e.g., novatel.com). The PwrPak7 automatically redirects you to the NovAtel Web User Interface which is hosted on the PwrPak7.



NovAtel Web User Interface is compatible with recent versions of Chrome, Firefox, Internet Explorer and Safari.



Cookies should always be on and never blocked on the browser being used to connect to the Wi-Fi network.

For more information about using the NovAtel Web User Interface, refer to the online OEM7 documentation ([docs.novatel.com/OEM7](https://docs.novatel.com/OEM7)).

To change the configuration of the Wi-Fi interface, including security key, refer to *PwrPak7 Wi-Fi Configuration* on page 99.



If the Wi-Fi security key is lost, use the **FRESET** command to reset the security key. Contact Customer Support to get the default security key.

#### **2.12.4 Ethernet Port**

The PwrPak7 has an RJ45 socket that supports 10Base-T/100Base-TX Ethernet for communications with external data communications equipment such as computers and data loggers. The Ethernet port supports IPv4 Internet layer, TCP/IP transport, ping and connection from a Telnet client. Users can conduct remote debugging, accept MRTCA (modified RTCA) data and download firmware. OEM7 receivers are also equipped with NTRIP Version 2.0 (Networked Transport of RTCM via Internet Protocol) client and server capability.

Refer to *Ethernet Configuration* on page 89 for instructions on configuring Ethernet and NTRIP.

#### **2.12.5 CAN Bus Port**

The PwrPak7 has a CAN Bus port available on the HD26 COM PORTS connector.

To connect to the CAN Bus port:

1. Connect the NovAtel All I/O SPAN cable (PN: 01020004), or a custom made cable, to the HD26 COM PORTS connector.



For information about the NovAtel All I/O SPAN cable, see *PwrPak7 All I/O SPAN Cable* on page 150. This section also has the connector pin out and connector recommendations for making a custom cable.

The *PwrPak7 All I/O Extension Cable* on page 153 (01020005) is an accessory for the 0102004 that connects to the DB15 connector on the 01020004 and provides individual wires for the CAN Bus signals.

2. Connect the CAN leads to the CAN Bus.



The PwrPak7 CAN bus port is unterminated. If the PwrPak7 is at the end of the bus, then the connecting cable must have 120 ohms integrated into the cable between CANH and CANL in close proximity to the HD26 COM PORTS connector.

For information about configuring CAN, see *CAN Bus* on page 102.

## 2.13 Connect I/O Signals to the PwrPak7

The PwrPak7 has several inputs and outputs, also referred to as strobes, that provide status and synchronization signals.

- Event Inputs
- Event Outputs
- Pulse Per Second (PPS) output
- Wheel Sensor inputs

For more information about the I/O signals, refer to the *PwrPak7 Strobe Specifications* on page 145.

To access the I/O signals, connect the PwrPak7 All I/O SPAN Cable (PN: 01020004), or a custom made cable, to the HD26 COM PORTS connector.

For information about the PwrPak7 All I/O SPAN Cable, see *PwrPak7 All I/O SPAN Cable* on page 150. This section also has the connector pin out and connector recommendations for making a custom cable.

The *PwrPak7 All I/O Extension Cable* on page 153 (01020005) is an accessory for the 0102004 that connects to the DB15 connector on the 01020004 and provides individual wires for each I/O signal.

## 2.14 Connect Power to the PwrPak7

To connect power to the PwrPak7:

1. Connect the M12 connector of the PwrPak7 Power Cable to the PWR port on the PwrPak7. See *PwrPak7 Power Cable* on page 149 for information about this cable.
2. Connect the bare wires of the power cable to a 9 to 36 VDC power supply. For details about the power supply required, see *Power Supply Requirements for the PwrPak7* on page 32.



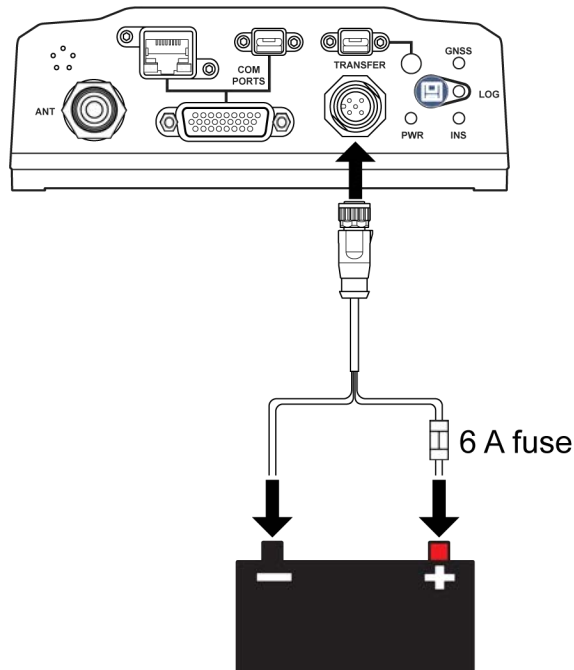
When connecting a single battery to the PwrPak7 Power Cable (01019764), it is recommended to connect the (+) Positive side of the battery to +VIN\_A and +VIN\_B wires, and (-) Negative side of the battery to -VIN\_A and -VIN\_B.

This configuration reduces voltage drops in the cable and will extend usable battery life somewhat when running on battery only (not charging).

### 2.14.1 Fuse for the Power Supply

Install a user supplied 6 A slow blow fuse in the positive line of the connection to the power source to protect the power supply wiring and your warranty.

**Figure 8: Fuse for PwrPak7 Power Supply**



For a 12 V system, the following are recommended.

**Table 10: Fuse/Holder Recommendations 12 V System**

Fuse	Holder
BK/MDA-6-R Fuse (or equivalent)	BK/HFA-R Fuse (or equivalent)
BK/MDL-6-R Fuse (or equivalent)	



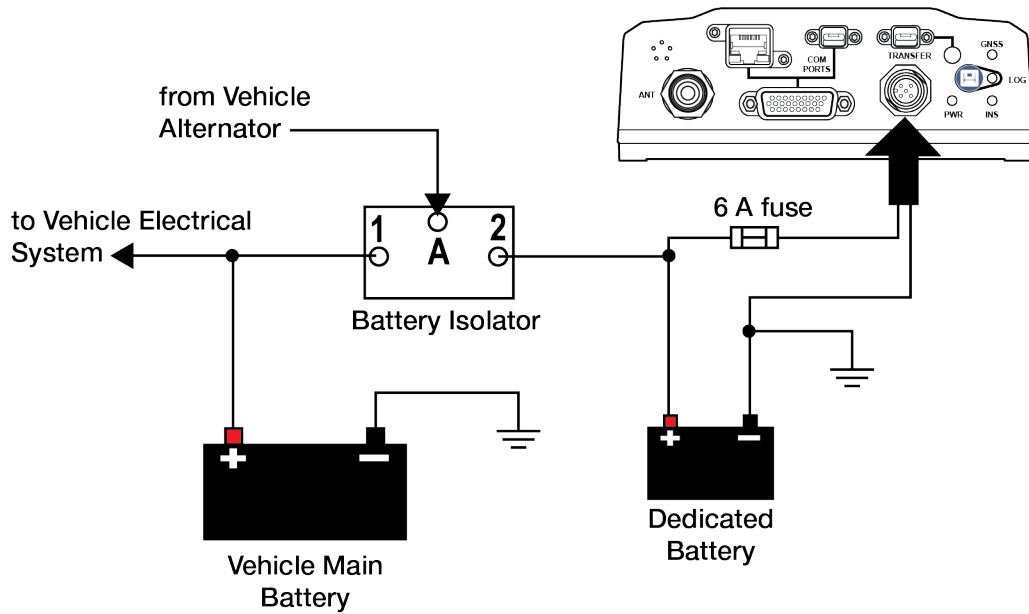
The fuse and holder are made by Cooper/Bussmann; available from Digikey.

### 2.14.2 Vehicle Installation

If the receiver is installed in a vehicle, it is recommended that a dedicated battery be provided for the receiver that is isolated from the engine starter battery. When a vehicle engine is

started, the voltage on the starter battery can dip below the PwrPak7 minimum voltage or cut-out to ancillary equipment causing the receiver to lose lock and calibration settings.

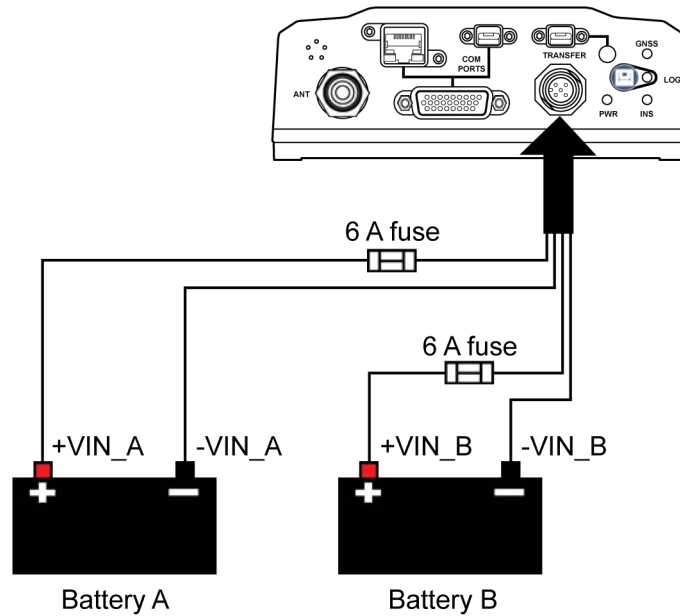
**Figure 9: Dedicated Battery for PwrPak7**



### 2.14.3 Seamless Battery Swap

Two batteries can be connected at the same time. If a battery requires charging, it can be removed without experiencing any power interruption (battery A or B).

**Figure 10: Seamless Battery Swap**





-VIN\_A and -VIN\_B are connected together inside the PwrPak7 and are also connected to DGND (Digital I/O ground and GNSS Cable shell). Power sources connected to the PwrPak7 must be floating, or have their (-) terminals connected to the same ground reference as any equipment connected to PwrPak7 (including the GNSS antenna).

Power sources with a positive ground **MUST NOT** be used, or severe damage to the PwrPak7 and/or connected equipment will result.

## 2.15 Check that the PwrPak7 is Operating

After the PwrPak7 is installed, powered up and connected to a GNSS antenna, use the following procedure to ensure the receiver is operating.

1. Check that the PWR LED is solid green.

Check that the GNSS LED is green (solid or blinking).

See *PwrPak7 LEDs* on page 25 for the location of the LEDs.

2. Send the following command:

```
LOG VERSION
```

The VERSION log is returned.

```
<VERSION USB1 0 63.5 FINESTEERING 1967 425380.518 02004020 3681 14434
< 11
< GPSCARD "FFNRNNCBES1" "BMHR17090005E" "OEM7700-1.00"
"OM7CR0301AN0012" "OM7BR0001RBG000" "2017/Sep/20" "05:46:39"
< OEM7FPGA "" "" "" "OMV070001RN0000" "" "" ""
< DEFAULT_CONFIG "" "" "" "EPP7D0301RN0002" "" "2017/Sep/20"
"05:47:04"
< WHEELSENSOR "" "" "" "SWS000100RN0000" "" "2017/Sep/20" "05:47:15"
< WIFI "RS9113" "" "" "1.6.8" "" "2017/Sep/20" "05:47:26"
< APPLICATION "" "" "" "EP7AR0301AN0012" "" "2017/Sep/20" "05:46:41"
< PACKAGE "" "" "" "EP7PR0100AN0012" "" "2017/Sep/20" "05:46:53"
< DB_WWWISO "WWWISO" "0" "" "WMC010201AN0004" "" "2017/Sep/20"
"21:00:04"
< ENCLOSURE "" "NMNE17200009B" "" "" "" "" ""
< REGULATORY "US" "" "" "" "" "" ""
< IMUCARD "Epson G320N" "" "" "" "" "" ""
```

3. Check that the Time Status is **FINESTEERING** which represents that time is fine set and being steered.
4. Check the Receiver Status word (02004020 in this example). If the lowest bit (bit 0) is set, the receiver has errors.



For information about the other digits in Receiver Status word, refer to the **RXSTATUS** log in the [OEM7 Commands and Logs Reference Manual](#).

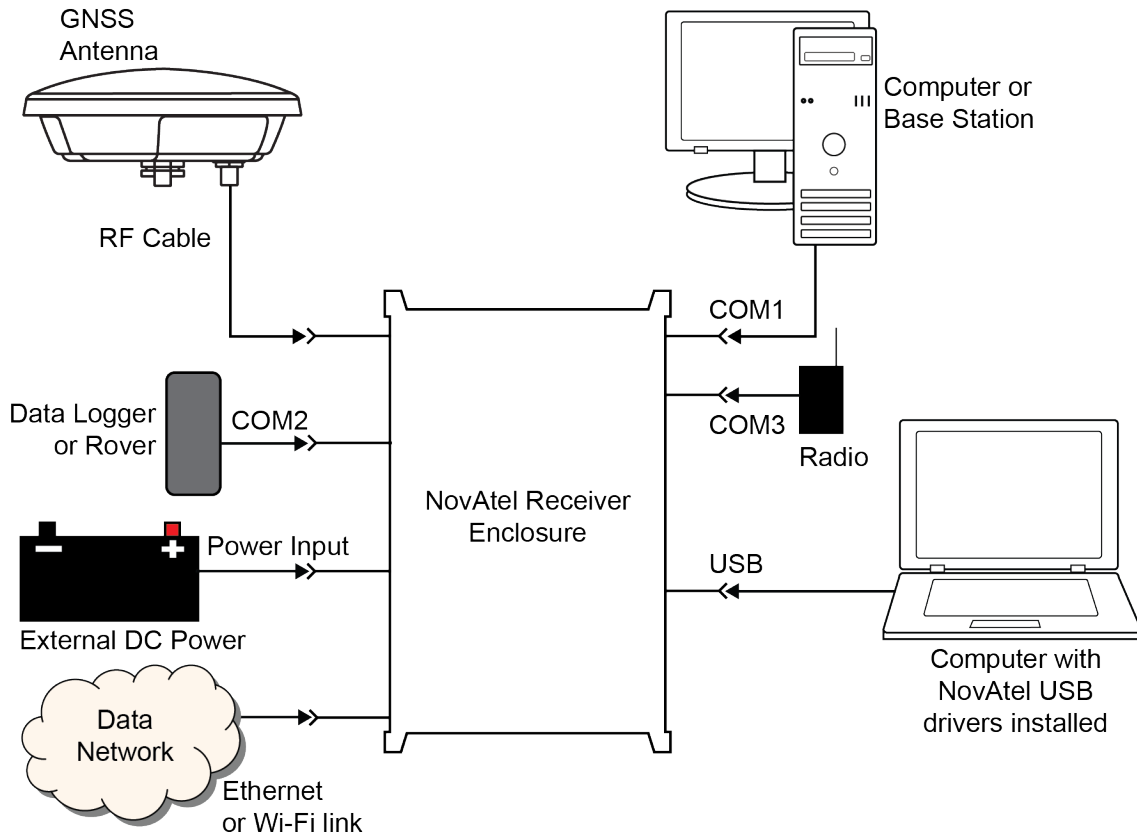


It can take about a minute for time status to reach FINESTEERING depending on number of satellites being tracked. This assumes the antenna is located in an open sky environment and the RF set up meets the requirements.

## Chapter 3 OEM7 Receiver Operation

Before operating the receiver for the first time, use the installation instructions in *PwrPak7 Installation* on page 29. The following instructions are based on a configuration similar to the following figure.

**Figure 11: Basic Receiver Enclosure Connection Interfaces (example)**



The figure above does not show all necessary hardware. Also see *Figure 12: Basic Differential Setup* on page 53 for a base/rover example.

### 3.1 Communications with the Receiver

Communication is established with the receiver using a data terminal or computer connected to the receiver by a variety of methods:

- *Wi-Fi Communications* on the next page
- *USB Communications* on the next page
- *Serial Port Communications* on page 48
- *Ethernet Communications* on page 50

- *ICOM Communications* on page 50
- *CAN Bus Communications* on page 51

When connected to the receiver, enter commands directly from a terminal or through terminal emulation software on a computer. For example:

- **NovAtel Web User Interface** - The NovAtel Web User Interface is installed on OEM7 receivers. Refer to the online OEM7 documentation ([docs.novatel.com/OEM7](https://docs.novatel.com/OEM7)) for instructions.
- **NovAtel Connect** - NovAtel Connect is a software application used to monitor and configure NovAtel receivers. For information about installing and using NovAtel Connect, refer to the help file included with the application.



NovAtel Connect version 2.0 or greater is required for OEM7 receivers. Download the latest NovAtel Connect software and documentation from [www.novatel.com/novatel-connect](https://www.novatel.com/novatel-connect).

- Any console/command line application

To maximize the application of the receiver's capabilities, become familiar with the commands and logs described in the [OEM7 Commands and Logs Reference Manual](#).

### 3.1.1 Wi-Fi Communications

Wi-Fi capable receivers are configured to run a 2.4 GHz 802.11 Access Point (AP) by default. The AP starts automatically when the receiver is powered on; no explicit configuration is required.

Establish a connection between the receiver and a Wi-Fi network by locating the receiver in the list of detected Wi-Fi devices. Once detected, it is easy to connect to any laptop, tablet or smartphone with Wi-Fi capability and a web browser.

Refer to the *Wi-Fi* on page 39 section in *Connect the PwrPak7 to Data Communication Equipment* on page 38 for instructions on starting a Wi-Fi connection to the PwrPak7.

To change the configuration of the PwrPak7 Wi-Fi interface, including password, refer to *PwrPak7 Wi-Fi Configuration* on page 99.

### 3.1.2 USB Communications

To communicate between an OEM7 receiver and a computer using a USB port, NovAtel USB drivers must be installed on the computer. These USB drivers are available on the NovAtel website at [www.novatel.com/novatel-connect](https://www.novatel.com/novatel-connect).



#### **PwrPak7**

The USB port in the **COM PORTS** label group can be used for communication between a computer and the PwrPak7.

The USB port labeled **TRANSFER** can not be used for communication. It is used for data logging and transferring data from the internal memory.

## USB Drivers

NovAtel USB drivers for OEM7 receivers are available for Windows 7, Windows 8, Windows 10 and Linux.

The NovAtel USB drivers provide three virtual serial ports over a single USB 2.0 connection. The three virtual serial ports are available to existing Windows or Linux applications which use COM ports to communicate (for example, NovAtel Connect). The NovAtel USB drivers assign COM port numbers sequentially following any existing ports on the computer. For example, if a computer has COM1 and COM2 ports, the NovAtel USB drivers assign COM3 to USB1, COM4 to USB2 and COM5 to USB3.



USB communications are not suitable for use in vehicles.



A computer has several USB ports. The assignment of COM port numbers is tied to a USB port on the computer. This allows receivers to be switched without Microsoft Windows assigning new COM ports. However, if the receiver is connected to a different physical USB port, Windows detects the receiver's presence and assigns three new COM port numbers.

### 3.1.3 Serial Port Communications

The receiver can communicate with a computer or terminal via a serial port. For communication to occur, both the receiver and the operator interface have to be configured properly. The receiver's default port settings are:

- 9600 bps
- no parity
- 8 data bits
- 1 stop bit
- no handshaking
- echo off
- break on

The data transfer rate determines how fast information is transmitted. Take for example a log whose message byte count is 96. The default port settings allows 10 bits/byte (8 data bits + 1 stop bit + 1 framing bit). It therefore takes 960 bits per message. To get 10 messages per second then requires 9600 bps. Also remember that even if you set the bps to 9600, the actual data transfer rate may be lower and depends on the number of satellites being tracked, data filters in use, and idle time. It is therefore suggested that you leave yourself a margin when choosing a data rate.





The minimum suggested baud rate for most applications is 115200 bps for GNSS only or 230400 bps for GNSS+INS. If the buffer overrun flag is present in the **RXSTATUS** log (refer to the [OEM7 Commands and Logs Reference Manual](#)), log at a higher baud rate if possible, or change to a medium supporting higher bandwidth (USB or Ethernet).



Although the receiver can operate at data transfer rates as low as 300 bps, this is not recommended. For example, if several data logs are active (that is, a significant amount of information needs to be transmitted every second) but the bit rate is set too low, data overflows the serial port buffers, causing an error condition in the receiver status that results in lost data.

The following ports are supported and can be configured using the commands listed. Refer to the commands listed in the [OEM7 Commands and Logs Reference Manual](#) for detailed instructions.

**Table 11: Serial Ports Supported**

Receiver Type	Port Supported	Configuration Command
PwrPak7	COM1, COM2, COM3	SERIALCONFIG and SERIALPROTOCOL

### Change the COM Port Settings

To change the settings on a COM port, use the **SERIALCONFIG** command. For example:

- To change the data rate of COM2 to 115200, enter:

```
SERIALCONFIG COM2 115200
```

- To change the data rate of COM1 to 57600 and enable even parity, enter:

```
SERIALCONFIG COM1 57600 E
```

### Configure a COM Port to Use RS-232 or RS-422

COM1 and COM2 of the PwrPak7 communicate using RS-232 protocol by default, but can be configured to use RS-422 protocol.

The **SERIALPROTOCOL** command is used to select RS-232 or RS-422 for the COM port.

Commands are executed after the receiver has completed booting so the communication lines may be configured incorrectly during the time taken to boot and before the command can be processed. For automatic configuration, the **SERIALPROTOCOL** command can be saved using the **SAVECONFIG** command.



After switching a COM port from RS-232 to RS-422, send a carriage return (CR) on the newly configured port to flush the buffer prior to sending new commands on the port.

### Communicating using a Remote Terminal

One method of communicating with the receiver is through a remote terminal. To communicate with the terminal, the receiver requires only the RX, TX and GND lines be used. Handshaking is

not required but is an option. Ensure the terminal's communications set up matches the receiver's port settings.

### Communicating using a Computer

A computer can emulate a remote terminal as well as provide the added flexibility of supporting multiple command batch files and data logging storage files. Use any standard communications software package that emulates a terminal to establish bidirectional communications with the receiver. Examples include NovAtel Connect and PuTTY. All data is sent as raw 8-bit binary or ASCII characters.

Refer to *Communicating with the Receiver* on the next page for details.

#### 3.1.4 Ethernet Communications

The PwrPak7 is equipped with a 10-Base-T/100-Base-TX Ethernet port that supports IPv4 Internet layer, TCP/IP transport and telnet. Users can conduct remote debugging, accept MRTCA (modified RTCA) data and update firmware. OEM7 receivers are also equipped with NTRIP Version 2.0 (Networked Transport of RTCM via Internet Protocol) client and server capability.

The Ethernet port must be configured before using. Refer to *Ethernet Configuration* on page 89 for configuration details.



The Ethernet ports are Safety Extra-Low Voltage (SELV) circuits only and are suitable for connection within a building only. Do not connect them to Telephone Network Voltage (TNV) circuits.

If intra-building connections are required, or the OEM7 receiver is installed in an outdoor enclosure, a suitably rated Ethernet router or switch should be installed between the receiver Ethernet port and the network connection.



Issue the **SAVEETHERNETDATA ETHA** command to ensure port settings are retained after a reset and automatically used at boot time. The **SAVEETHERNETDATA ETHA** command is not applicable to the **ICOMCONFIG** and **NTRIPCONFIG** command settings. The **SAVEETHERNETDATA ETHA** command takes precedence over the **SAVECONFIG** command configuration.

#### 3.1.5 ICOM Communications

ICOM ports are virtual ports used for Ethernet or Wi-Fi connections. The transport/application layer of the ICOM ports can be configured to use Transmission Control Protocol (TCP) for internet IP or User Datagram Protocol (UDP) a slower and less reliable IP protocol.

Refer to **DNSCONFIG** command for Ethernet DNS configuration. If using DHCP, DNS is automatically set.

The following are the default ICOM configurations:

- ICOMCONFIG ICOM1 TCP :3001
- ICOMCONFIG ICOM2 TCP :3002
- ICOMCONFIG ICOM3 TCP :3003

- ICOMCONFIG ICOM4 TCP :3004
- ICOMCONFIG ICOM5 TCP :3005
- ICOMCONFIG ICOM6 TCP :3006
- ICOMCONFIG ICOM7 TCP :3007

Each ICOM port can act as a server (waiting for an external connection to be made) or as a client (actively establishing a connection to a specific port).

For details on the ICOM port commands, refer to **IPCONFIG** command, **ICOMCONFIG** command and **ETHCONFIG** command in the [OEM7 Commands and Logs Reference Manual](#).

### 3.1.6 CAN Bus Communications

The OEM7 receiver supports J1939 and NMEA2000 CAN protocols.

The PwrPak7 has one CAN port. This CAN port supports data rates up to 1 Mbps.

The SMART2 has one CAN port. This CAN port supports data rates up to 1 Mbps.

Proper bus termination is required.

Refer to *CAN Bus* on page 102 for detailed instructions.

## 3.2 Getting Started

The receiver's software resides in flash memory. When first powered, it undergoes a complete self-test. If an error condition is detected during the self-test, the status word changes. This self-test status word can be viewed in the header of any data output log. Refer to Messages in the [OEM7 Commands and Logs Reference Manual](#) for header information. If a persistent error occurs, contact your local NovAtel dealer. If the dealer cannot resolve the problem, contact NovAtel Customer Support directly using one of the methods listed in *Customer Support* on page 20.

### 3.2.1 Communicating with the Receiver

You can communicate with the receiver using NovAtel Web User Interface, NovAtel Connect or a terminal emulation program.



Detailed instructions for using NovAtel Connect are available from the Help system built into NovAtel Connect.



For instructions on using NovAtel Web User Interface, refer to the online OEM7 documentation ([docs.novatel.com/OEM7](https://docs.novatel.com/OEM7)).

When the receiver is first turned on, no data is transmitted from the COM ports except for the port prompt.

Any of the COM port prompts indicate that the receiver is ready and waiting for command input. The screen may display other port names for other port types.



1. Output from receiver self-tests may take some time. On startup, the OEM7 receiver is set to log the RXSTATUSEVENTA log ONNEW on all ports. See *RXSTATUSEVENT Log* on page 85 for more details.
2. If NovAtel Connect is unable to locate the OEM7 receiver, use a different COM port to communicate with the receiver. When communication has been established, issue a **FRESET STANDARD** command. The original communications port should be ready for use. See the **FRESET** command for more information.

An example of a response to an input **FIX POSITION** command:

```
[COM2] FIX POSITION 51.11635 -114.0383 1048.2 [Carriage Return]
<OK
```

In this example, [COM2] is the port prompt.

This example illustrates command input to the base receiver's COM2 port that sets the position of the base station receiver for differential operation.

If the command was accepted, the receiver responds with:

```
<OK
```

If a command is entered incorrectly, the receiver responds with:

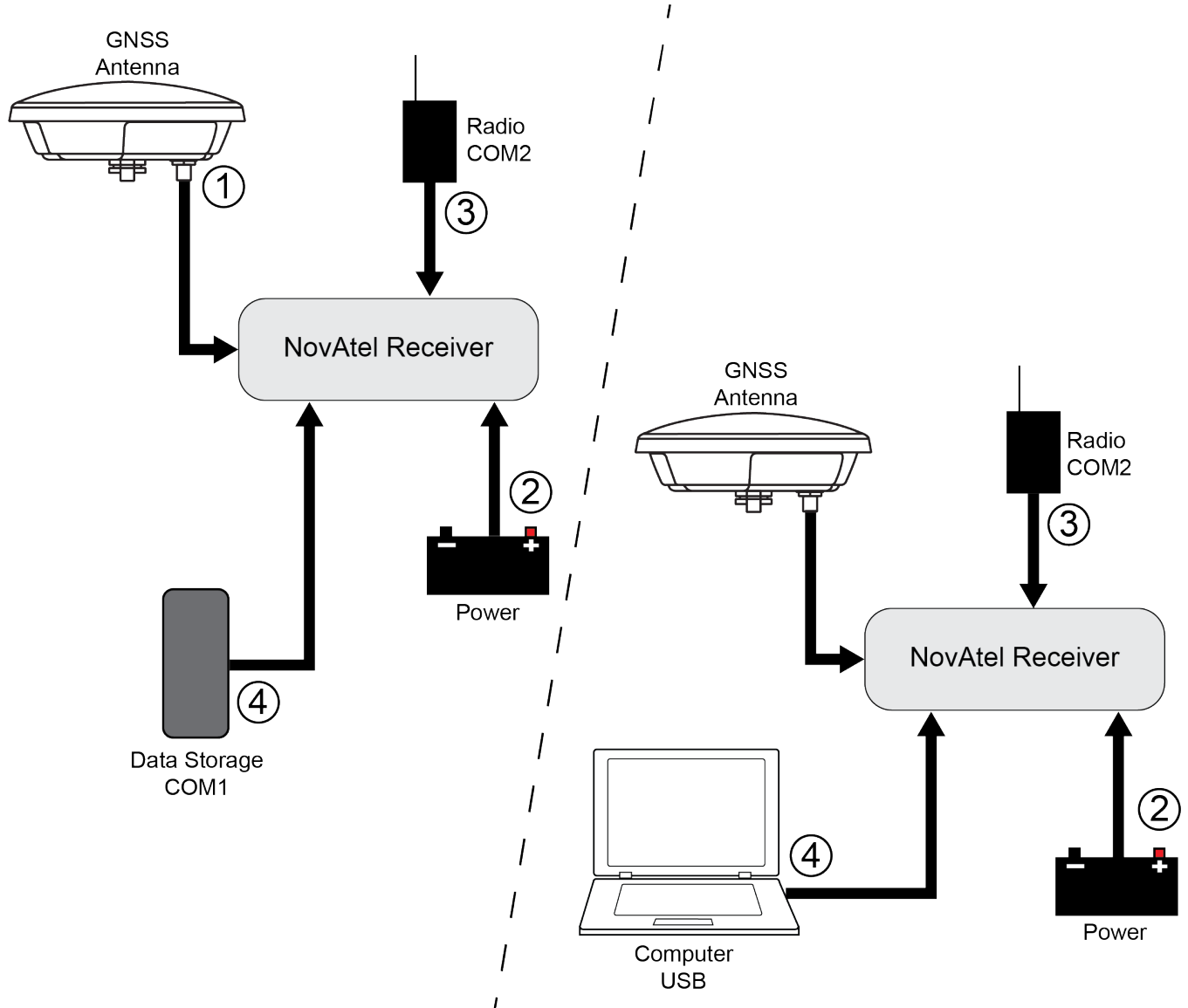
```
<ERROR:Invalid Message ID (or a more detailed message)
```



Ensure the computer does not sleep or hibernate during a logging session or data will be lost.

### 3.3 Transmitting and Receiving Corrections

Corrections can be transmitted from a base station to a rover station to improve position accuracy. The base station is the GNSS receiver that acts as the stationary reference. The stationary reference has a known position and transmits correction messages to the rover station. The rover station is the GNSS receiver that does not know its exact position and requires correction messages from a base station to calculate differential GNSS positions. An example of a differential setup is shown in *Figure 12: Basic Differential Setup* on the next page.

**Figure 12: Basic Differential Setup****Rover Setup**

- 1 Mount and connect a GNSS antenna
- 2 Connect a fused power supply (user supplied)
- 3 Connect a radio device to COM2 (user supplied)
- 4 Connect a storage device to COM1 (user supplied)

**Base Setup**

- 1 Mount and connect a GNSS antenna
- 2 Connect a fused power supply (user supplied)
- 3 Connect a radio device to COM2 (user supplied)
- 4 Connect a computer to COM1 for setup and monitoring (user supplied)

To receive corrections, a data link between the base station and the rover station is required. The base and rover stations can both be NovAtel receivers, however NovAtel receivers will work with some other brands. Contact Customer Support for further details (refer to *Customer Support* on page 20 for details).

The data link should support a rate of at least 19200 bits per second, but a rate of 115200 bits per second, with less than 4.0 s latency, is recommended.



Unlike the base/rover concept, SBAS and PPP corrections can be applied directly to a single receiver.

When the base and rover are set up, configure them as shown in the configuration examples in *Base Station Configuration* below and *Rover Station Configuration* on the next page.

### 3.3.1 Defining Antenna and Base Antenna

The type of antenna for the receiver and/or the base receiver can be defined using the **THISANTENNA** command and **BASEANTENNA** command respectively.

The Phase Center Variation (PCV) and the Phase Center Offset (PCO) for each can also be specified using the **THISANTENNA** command and **THISANTENNA** command or the **BASEANTENNA** command and **BASEANTENNA** command.

Refer to the [OEM7 Commands and Logs Reference Manual](#) for command details.

### 3.3.2 Base Station Configuration

At the base station, enter the following commands:

```
serialconfig [port] baud [parity[databits[stopbits[handshaking[break]]]]]
interfacemode port rx_type tx_type [responses]
fix position latitude longitude height (enter your own lat, long and hgt values)
log port message [trigger [period]] (port = COM2 / refer to Figure 12: Basic Differential Setup on the previous page)
saveconfig (optional)
```

The following sections are examples of base station configurations.

#### RTK Automated Correction Generation

```
fix position lat lon hgt (enter your own lat, lon, hgt)
generatertkcorrections rtkmv3 com2
```

#### RTCM V3

```
serialconfig com2 19200 N 8 1 N on
interfacemode com2 none rtkmv3 off
fix position lat lon hgt (enter your own lat, lon, hgt)
log com2 rtkm1004 ontime 1
log com2 rtkm1006 ontime 10
log com2 rtkm1019 ontime 120
saveconfig (optional)
```

#### RTCM V3 with GLONASS

```

serialconfig com2 19200 N 8 1 N on
interfacemode com2 none rtcmv3 off
fix position lat lon hgt (enter your own lat, lon, hgt)
log com2 rtcml004 ontime 1
log com2 rtcml012 ontime 1
log com2 rtcml006 ontime 10
log com2 rtcml033 ontime 10
log com2 rtcml019 ontime 120
log com2 rtcml020 ontime 120
saveconfig (optional)

```

**NOVATELX**

```

serialconfig com2 19200 N 8 1 N on
interfacemode com2 none novatelx off
fix position lat lon hgt (enter your own lat, lon, hgt)
log com2 novatelxobs ontime 1
saveconfig (optional)

```



For more information, refer to the **FIX** command, **INTERFACEMODE** command, **SAVECONFIG** command and **SERIALCONFIG** command.

**3.3.3 Rover Station Configuration**

At the rover station, enter the following commands:

```

serialconfig [port] baud [parity[databits[stopbits[handshaking[break]]]]]
interfacemode port rx_type tx_type [responses]
saveconfig (optional)

```

The following sections are examples of rover configurations, if COM2 was connected to the correction source.

**RTK Automated Correction Detection**

```

serialconfig com2 19200 N 8 1 N on
interfacemode com2 auto none off
saveconfig (optional)

```

**RTCM V3**

```

serialconfig com2 19200 N 8 1 N on
interfacemode com2 rtcmv3 none off
saveconfig (optional)

```

**RTCM V3 with GLONASS**

```
serialconfig com2 19200 N 8 1 N on
interfacemode com2 rtcmv3 none off
saveconfig (optional)
```

**NOVATELX**

```
serialconfig com2 19200 N 8 1 N on
interfacemode com2 NOVATELX none off
saveconfig (optional)
```



For more information, refer to the **INTERFACEMODE** command, **SAVECONFIG** command and **SERIALCONFIG** command.

**3.3.4 Configuration Notes**

For compatibility with other GNSS receivers and to minimize message size, use the standard form of RTCMV3 corrections shown in the base and rover examples in *Transmitting and Receiving Corrections* on page 52. This requires using the **INTERFACEMODE** command to dedicate one direction of a serial port to one message type only. When the **INTERFACEMODE** command is used to change the mode from the NOVATEL default, the NovAtel format messages can no longer be used.

To mix NovAtel format messages and RTCM V3 messages on the same port, leave the interface mode set to NOVATEL and log out variants of the standard correction messages with a NovAtel header. ASCII or binary variants can be requested by appending an A or B to the standard message name. For example, on the base station:

```
interfacemode com2 novatel novatel
fix position 51.11358042 -114.04358013 1059.4105
log com2 rtcml004b ontime 2
```



1. Interface mode must be set to NOVATEL for the receiver to issue logs with an A or B suffix.
2. Using the receiver in NOVATEL mode consumes more CPU bandwidth than using the native differential messages as shown in *Base Station Configuration* on page 54.
3. To find information on how to send multiple commands and log requests from a computer, search our knowledge database available at [www.novatel.com/support/](http://www.novatel.com/support/).

At the rover, leave the interface mode default settings (interfacemode com2 novatel novatel). The rover recognizes the default and uses the corrections it receives with a NovAtel header.

The **PSRDIFFSOURCE** command and **RTKSOURCE** command set the station ID values that identify the base stations from which to accept pseudorange or RTK corrections. They are useful commands when the rover station is receiving corrections from multiple base stations.



## 3.4 ALIGN Heading Master and Remote Configurations

ALIGN technology combines two or more receivers to generate high precision heading and pitch angles between two receivers for real-time navigation.

This section provides instructions for setting up a master station with an ALIGN capable rover receiver for applications that require heading output. Refer to [APN-048 ALIGN Overview and Setup](#), available at [www.novatel.com/support/](http://www.novatel.com/support/).



Dual antenna receivers, such as the PwrPak7D, PwrPak7D-E1 and PwrPak7D-E2, can provide an ALIGN solution without additional receivers or configuration.

This section is for applications that require additional rover receivers.



A dual frequency capable GNSS antenna is required to use SPAN, RTK, ALIGN or dual frequency GLIDE.

### 3.4.1 Automatic Set Up for Direct-Wire Connection between Master and Rover via COM2

The **ALIGNAUTOMATION** command must only be sent to the rover.

```
ALIGNAUTOMATION ENABLE
```

or

```
ALIGNAUTOMATION ENABLE COM2 230400 10 ON
```

### 3.4.2 Manual Set Up via COM2

#### Master:

```
serialconfig com2 230400 N 8 1 N on
interfacemode com2 novatel novatex off
movingbasestation enable
log com2 novatexobs ontime 1
log com2 novatexref ontime 1
log headinga onnew
log gphdt onnew
```

#### Rover:

```
serialconfig com2 230400 N 8 1 N on
interfacemode com2 novatex novatel off
rtkportmode com2 ALIGN
log com2 headingext2b onnew
log headinga onnew
log gphdt onnew
hdtoutthreshold 1.0
```

## 3.5 GLIDE

NovAtel's GLIDE® is a positioning algorithm for single-frequency GPS and GPS/GLONASS applications. GLIDE produces a smooth position output tuned for applications where time relative accuracy (pass-to-pass) is more important than absolute accuracy. Because of this, it is well suited for agricultural applications.

Multipath signals tend to induce time varying biases and increase the measurement noise on the L1/L2 pseudorange measurements. Carrier phase measurements are much less susceptible to the effects of multipath. The GLIDE algorithm fuses the information from the L1 code and the L1 phase measurements into a Position Velocity Time (PVT) solution.

GLIDE includes settings for a dynamic mode, a static mode and an "auto" mode, where the filtering parameters are automatically adjusted as vehicle velocity varies between stationary and dynamic states.

### 3.5.1 Dual-Frequency GLIDE

NovAtel's dual-frequency GLIDE technology adds to the superior pass-to-pass performance provided by single-frequency GLIDE. Dual-frequency GLIDE is ideal for agricultural and machine guidance applications where relative positioning is critical. Using GLIDE significantly reduces the variation in position errors to less than 1 cm from one epoch to the next. Dual-frequency GLIDE improves the absolute accuracy of the GLIDE position and creates a robust solution resistant to the effects of high ionospheric activity. GLIDE works in all code positioning modes, including single point, DGNSS and SBAS.

Refer to the NovAtel white paper on [GLIDE Technology](#) for more information on GLIDE and [APN-038 Pseudorange/Delta-Phase \(PDP\) and GLIDE Filters](#) along with other information available from [www.novatel.com/support/search/](http://www.novatel.com/support/search/).

### 3.5.2 PDP and GLIDE Configurations

Pseudorange/Delta-Phase (PDP) and GLIDE position filters can be used for single-frequency single point, WAAS or DGNSS positioning. Refer to the **PDPFILTER** command and **PDPMODE** command in the [OEM7 Commands and Logs Reference Manual](#).

To reset the PDP or GLIDE filter:

```
pdpfilter reset
```

To enable the PDP filter:

```
pdpfilter enable
```

Ensure the **PDPFILTER** command is used before the **PDPMODE** command. Set the PDP type and kinematic type according to the application. For most kinematic applications:

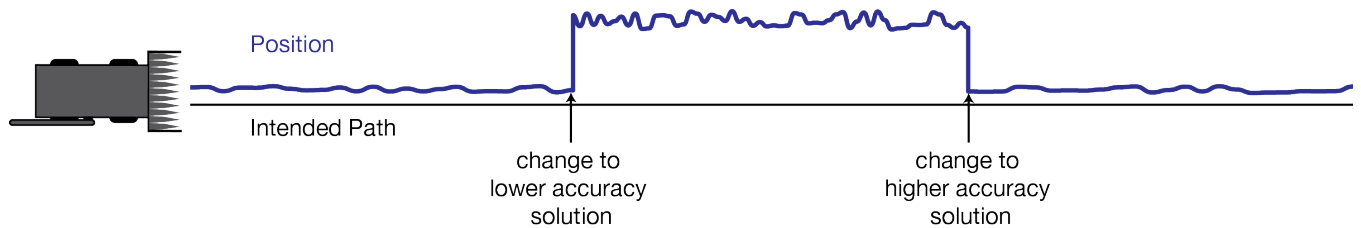
```
pdpmode relative dynamic OR pdpmode relative auto
```

The rest of the setup is position type and log dependent according to the application. See the **PSRDIFFSOURCE**, **INTERFACEMODE**, **SERIALCONFIG** and other configuration commands which are outlined in the [OEM7 Commands and Logs Reference Manual](#). Also refer to the NovAtel application note [APN-038 Pseudorange/Delta-Phase \(PDP\) and GLIDE](#) available from our web site at [www.novatel.com/support/](http://www.novatel.com/support/).

## 3.6 STEADYLINE

The STEADYLINE® functionality helps mitigate the discontinuities that often occur when the receiver changes GNSS positioning modes. The effect is especially evident when a receiver transitions from an RTK position mode solution to a lower accuracy “fall back” solution, such as DGPS, WAAS+GLIDE or even autonomous GLIDE (see *Figure 13: Positioning Change Without STEADYLINE* below). Smooth transitions are particularly important for agricultural steering applications where sudden jumps are problematic.

**Figure 13: Positioning Change Without STEADYLINE**



The STEADYLINE feature internally monitors the position offsets between all the GNSS positioning modes present in the receiver. When the current positioning mode becomes unavailable, the receiver transitions to the next most accurate positioning mode.

The setting in the **STEADYLINE** command determines how the receiver transitions to the next positioning mode. The following sections describe the STEADYLINE modes.

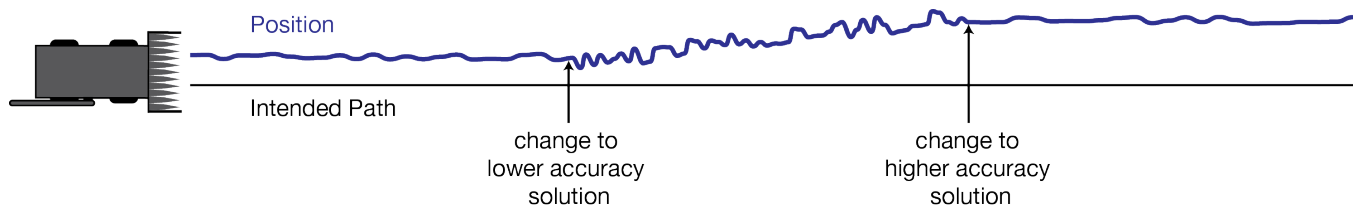


Refer to the [OEM7 Commands and Logs Reference Manual](#) for log and command details.

### 3.6.1 Maintain

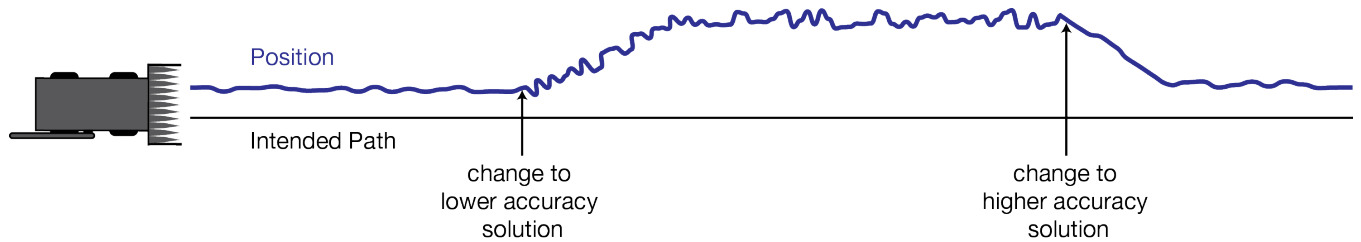
When the receiver transitions to a different positioning mode, it maintains the position offset calculated to limit a potential real position jump. The receiver continues to apply the position offset to all positions calculated in the new positioning mode.

**Figure 14: STEADYLINE Maintain**



### 3.6.2 Transition

When the receiver transitions to a different positioning mode, the position offset is applied to the calculated position to limit a potential real position jump. The position then slowly transitions to the new reference position type over a specified period of time. This time period is specified by the Transition time parameter in the **STEADYLINE** command.

**Figure 15: STEADYLINE Transition**

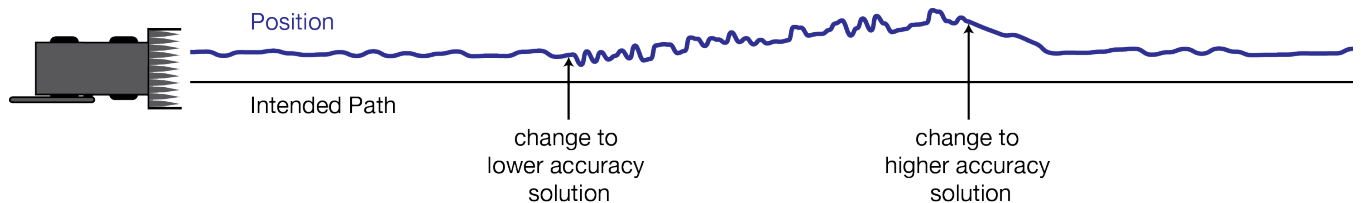
### 3.6.3 Prefer Accuracy

The positioning mode change depends on the accuracy level of the positioning modes.

When the position mode is changing from a more accurate mode to a less accurate mode (e.g., changing from RTK to GLIDE), the receiver uses the Maintain option.

When the position mode is changing from a less accurate mode to a more accurate mode (e.g., GLIDE to RTK), the receiver uses the Transition option.

For example, a receiver is configured to do both RTK and GLIDE. If this receiver has a fixed RTK position and experiences a loss of correction data causing the loss of the RTK solution it will immediately apply the offset between the two position modes and uses the GLIDE position stability to maintain the previous trajectory. Over time the GLIDE (or non-RTK) position will experience some drift. Once the RTK position is achieved again the receiver will start using the RTK positions for position stability and will slowly transition back to the RTK positions at a default rate of 0.005 m/s or the time specified in the **STEADYLINE** command.

**Figure 16: STEADYLINE Prefer Accuracy**

### 3.6.4 UAL



User Accuracy Level (UAL) mode will not function unless UALCONTROL is enabled using the **UALCONTROL** command.

The STEADYLINE mode used depends on the BESTPOS and GPGGA solution types.

When the solution type is OPERATIONAL, the receiver uses the Maintain option.

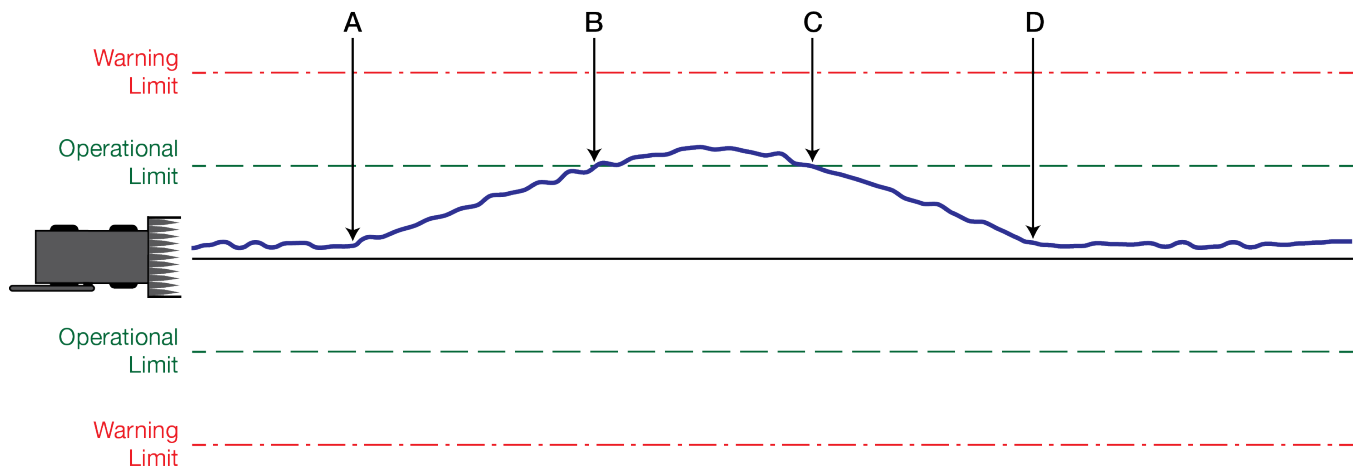
When the solution type is WARNING, the receiver uses the Prefer Accuracy option. When the receiver changes from WARNING to OPERATIONAL, it will continue to use the Prefer Accuracy option until any existing offset is gone.

When the solution type is OUT\_OF\_BOUNDS, the STEADYLINE feature is disabled.

The thresholds used to determine the solution type (OPERATIONAL, WARNING or OUT\_OF\_BOUNDS), can be specified using the **UALCONTROL** command. Refer to the [OEM7 Commands and Logs Reference Manual](#).

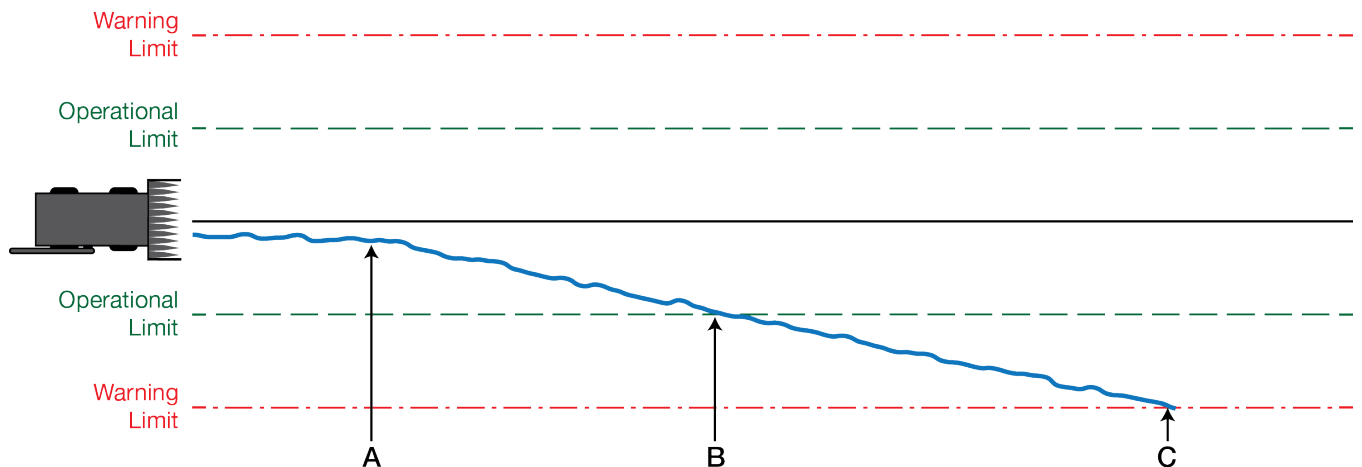
Figure 17: STEADYLINE UAL- Warning Limit Example below and Figure 18: STEADYLINE UAL - Out of Bounds Example below show examples of STEADYLINE using the UAL mode.

**Figure 17: STEADYLINE UAL- Warning Limit Example**



- A Position type is OPERATIONAL.  
Higher accuracy corrections are lost. The receiver changes to a lower accuracy solution. STEADYLINE operates in Maintain mode while the solution accuracy remains within the Operational limit.
- B The solution accuracy exceeds the operational limit. The position type changes to WARNING. The STEADYLINE mode changes from Maintain to Prefer Accuracy.
- C The solution accuracy moves back within the operational limit. The position type changes to OPERATIONAL. The STEADYLINE mode remains in Prefer Accuracy mode.
- D The solution offset is removed. The STEADYLINE mode changes from Prefer Accuracy to Maintain.

**Figure 18: STEADYLINE UAL - Out of Bounds Example**



- A The position type is OPERATIONAL.  
Higher accuracy corrections are lost. The receiver changes to a lower accuracy solution. STEADYLINE operates in Maintain mode while solution accuracy remains within the Operational limit.
- B The solution accuracy exceeds the operational limit. The position type changes to WARNING. The STEADYLINE mode changes from Maintain to Prefer Accuracy.
- C The solution accuracy exceeds the warning limit. The position type changes to OUT\_OF\_BOUNDS. STEADYLINE is disabled.

## 3.7 Enabling SBAS Positioning

OEM7 receivers are capable of SBAS positioning. This positioning mode is enabled using the **SBASCONTROL** command:

```
sbascontrol enable auto
```

When the command is entered, the OEM7 receiver automatically tracks the SBAS that is operating in the region (e.g., WAAS or EGNOS) and applies the corrections from the service. On a simulator, leave the test mode parameter off or specify NONE explicitly. For more on SBAS, refer to application note [APN-051 Positioning Modes of Operation](#) (additional Application Notes available at [www.novatel.com/support/](http://www.novatel.com/support/)).

## 3.8 Enabling PPP

L-Band equipped receivers can achieve sub-metre position accuracy using correction data received from geostationary satellites. To use the L-Band corrections, an L-Band-capable receiver model and antenna are required (refer to our web site [www.novatel.com/products/gnss-antennas](http://www.novatel.com/products/gnss-antennas) for information on NovAtel L-Band-capable antennas).

For more information on L-Band positioning, refer to:

- NovAtel Application Notes: *APN-061: NovAtel CORRECT with PPP using TerraStar Corrections* or *APN-062 NovAtel CORRECT with Veripos* (service dependent) available from [www.novatel.com/support/search/items/Application%20Note](http://www.novatel.com/support/search/items/Application%20Note)
- the [OEM7 Commands and Logs Reference Manual](#) for log/command details and/or
- visit [www.novatel.com/support](http://www.novatel.com/support)
- visit [www.novatel.com/products/novatel-correct](http://www.novatel.com/products/novatel-correct)

### 3.8.1 TerraStar Subscriptions

A subscription is required to use TerraStar service for land, airborne and near shore applications. Near shore applications are defined as vessels operating within 10 km of shore. For more information about TerraStar services, visit [www.novatel.com/products/terrastar-gnss-corrections](http://www.novatel.com/products/terrastar-gnss-corrections). To obtain a subscription, contact your local NovAtel sales representative. The NovAtel product serial number (PSN) is needed to obtain a subscription. To obtain the receiver serial number, enter the following command:

```
log version once  
  
<VERSION USB1 0 74.0 FINESTEERING 2045 336197.080 02028020 3681 15341  
< 11
```

```

< GPSCARD "FFNRNNCBES1" "BMHR17090005E" "OEM7700-1.00" "OM7CR0504RN0000"
"OM7BR0001RBG000" "2019/Jan/17" "07:30:03"
< OEM7FPGA "" "" "" "OMV070001RN0000" "" "" ""
< WHEELSENSOR "" "" "" "SWS000101RN0000" "" "2019/Jan/17" "07:30:30"
< WIFI "RS9113" "" "" "1.6.8" "" "2019/Jan/17" "07:30:35"
< APPLICATION "" "" "" "EP7AR0504RN0000" "" "2019/Jan/17" "07:30:16"
< DEFAULT_CONFIG "" "" "" "EP7CR0504RN0000" "" "2019/Jan/17" "07:30:26"
< PACKAGE "" "" "" "EP7PR0504RN0000" "" "2019/Jan/17" "07:30:21"
< DB_WWWISO "WWWISO" "0" "" "WMC010201AN0004" "" "2017/Sep/20" "21:00:04"
< ENCLOSURE "" "NMNE17200009B" "" "" "" "" ""
< REGULATORY "US" "" "" "" "" "" ""
< IMUCARD "Epson G320N" "" "" "" "" "" ""

```

In the example above, the receiver serial number is **BMHR17090005E**.

To activate a subscription, the receiver must be powered and tracking an L-Band TerraStar satellite prior to the planned activation time. Use the **ASSIGNLBANDBEAM** command to configure the receiver to track the TerraStar satellite.

```
ASSIGNLBANDBEAM auto
```

To confirm tracking of an L-Band signal, log the L-Band tracking status information by entering the following command:

```
log lbandtrackstata

#LBANDTRACKSTATA,COM1,0,73.5,FINESTEERING,1769,328196.000,00000000,29fd,
12602;1,"98W",1539902500,1200,974c
00c2,0,-316.186,43.842,4.3840,61.920,1088,2,2,138176,79,0.0001*3e43cb7d

```

If receiving an L-Band signal from a geostationary satellite, the sixth field following the header (tracking status word) of the LBANDTRACKSTAT log will be 00c2, as shown in the example.



The latest services and coverage can be obtained from [www.novatel.com/products/novatel-correct-ppp/](http://www.novatel.com/products/novatel-correct-ppp/). For additional information on TerraStar activation, contact NovAtel Customer Service at [www.novatel.com/support](http://www.novatel.com/support) or download *APN-061 NovAtel CORRECT with TerraStar* from: [www.novatel.com/support/search/items/Application%20Note](http://www.novatel.com/support/search/items/Application%20Note)

To confirm the TerraStar subscription status, send the **TERRASTARSTATUS** log:

```
log terrastarstatus

[COM1]<TERRASTARSTATUS COM1 0 74.0 FINESTEERING 1886 418216.025 00000020 fdc1
13386 ENABLE LOCKED 0 IN_RANGE DISABLED
[COM1]

```

The first field after the log header will be **ENABLED** to indicate the TerraStar subscription is valid. The second field after the log header will be **LOCKED** to indicate the decoder is locked to the data format.

To monitor the PPP convergence, send the **PPPPPOS** log:

```
log ppppos ontime 1

[COM1]<PPPPPOS COM1 0 76.0 FINESTEERING 1886 418465.000 00000020 ec34 13386 SOL_
COMPUTED PPP_CONVERGING 51.11679035745 -114.03886212905 1064.9475 -16.9000

```

```
WGS84 0.7097 0.6867 1.2333 "TSTR" 25.000 0.000 18 17 17 17 00 00 00 33
[COM1]
```

### 3.8.2 Veripos Subscriptions



Subscriptions to the Veripos Apex and Apex<sup>2</sup> marine services must be obtained directly from Veripos. A unit with a marine subscription can not be switched to a land subscription and vice versa.

A subscription is required to use the [Veripos services](#) for offshore marine applications. Contact Veripos sales at [veripos.com/support](http://veripos.com/support) to obtain a Service Access License (SAL) number. To activate the service, contact the Veripos Help Desk at +44 (0) 1224 527 104 or visit [veripos.com/support](http://veripos.com/support). Provide the SAL number and the receiver's Veripos Serial Number (VSN). To obtain the receiver-specific VSN, enter the following command:

```
log veriposinfo
```

The log displays the VSN in the first field following the log header and also displays the status of your subscription.

To activate a subscription, the receiver must be powered and tracking an L-Band Veripos satellite prior to the planned activation time. Use the **ASSIGNLBANDBEAM** command to configure the receiver to track the Veripos satellite.

```
assignlbandbeam auto
```



The latest services and coverage can be obtained from [www.veripos.com](http://www.veripos.com). For additional information on Veripos activation, contact NovAtel Customer Service at [www.novatel.com/support](http://www.novatel.com/support) or download the APN-062 NovAtel CORRECT with Veripos from: [www.novatel.com/support/search/items/Application%20Note](http://www.novatel.com/support/search/items/Application%20Note)

## 3.9 RTK ASSIST

RTK ASSIST™ is a feature that enables centimetre-level accuracies to be maintained through extended RTK correction outages. With RTK ASSIST, RTK-dependent operations can continue through RTK correction outages as long as 20 minutes.

RTK ASSIST uses correction data provided by TerraStar. To obtain these corrections, an L-Band capable receiver is required and L-Band tracking must be enabled using the **ASSIGNLBANDBEAM** command.

RTK ASSIST also requires a subscription to the RTK ASSIST service. To obtain a subscription, contact your local NovAtel sales representative or visit [www.novatel.com/products/terrastar-gnss-corrections/](http://www.novatel.com/products/terrastar-gnss-corrections/). The NovAtel Product Serial Number (PSN) is needed to obtain a subscription. The PSN is available from the **VERSION** log.

RTK ASSIST is available as soon as the rover receiver has at least one valid RTK solution and has received the RTK ASSIST correction data. If an RTK correction outage occurs, then RTK ASSIST will maintain RTK mode until the subscription-permitted RTK ASSIST duration is exceeded. A shorter, user-defined RTK ASSIST time out can also be set using the **RTKASSISTTIMEOUT** command. Normal RTK operation will seamlessly resume if RTK corrections are restored at any point while RTK ASSIST is operating.



RTK ASSIST will report the RTK solution type that was present before RTK corrections were lost, unless the estimated solution standard deviation exceeds the threshold set by the **RTKINTEGERCRITERIA** command. If this occurs, then integer RTK solutions will be downgraded to their float RTK equivalent.

RTK ASSIST is enabled by default, but can be disabled using the **RTKASSIST** command. To monitor the status of RTK ASSIST, view the **RTKASSISTSTATUS** log.

Refer to the [OEM7 Commands and Logs Reference Manual](#) for log and command details.



RTK ASSIST typically provides 4 cm accuracy. However, if the RTK outage occurs during the first 30 minutes of receiver operation, the position accuracy provided by RTK ASSIST may be lower.



Additional information about enabling and using RTK ASSIST is available in the RTK ASSIST Application Note (available from our website: [www.novatel.com/assets/Documents/Bulletins/APN-073-RTK-ASSIST.pdf](http://www.novatel.com/assets/Documents/Bulletins/APN-073-RTK-ASSIST.pdf)).

## 3.10 Transferring Time Between Receivers

The **ADJUST1PPS** command is used as part of the procedure to transfer time between receivers. The number of Pulses Per Second (PPS) is always set to 1 with this command. It is typically used when the receiver is not adjusting its own clock and is using an external reference frequency.

The **TIMESYNC** log is also used to synchronize time between receivers. It contains a time status field that may show COARSE or FINE, among others. For a complete list of the time status values and definitions, refer to GPS Reference Time Status in the [OEM7 Commands and Logs Reference Manual](#).

*Procedures to Transfer Time* on the next page provides details on the time transfer procedure. Terms used in the procedure are defined in *Time Definitions* below. Refer also to the **ADJUST1PPS** command and the **TIMESYNC** log in the [OEM7 Commands and Logs Reference Manual](#).

### 3.10.1 GPS to Receiver Time Synchronization

Receiver time synchronization with GPS time does not occur until the receiver locks onto the first satellite. The GPS L1 signal has two main streams of data modulated on the carrier. These data streams are the C/A code (1.023 MHz rate) and the P(Y) code (10.23 MHz rate). Additionally, a navigation message (at a 50 Hz rate) contains GPS satellite data including the ephemeris, clock corrections and constellation status. This navigation message is encoded on both the C/A and P(Y) codes. The navigation message is transmitted via individual subframes and each subframe is 300 bits in length. With the 50 Hz data bit rate there is a new subframe transmitted every six seconds.

### 3.10.2 Time Definitions

The following are related definitions:

#### Coarse Time

Each subframe contains the transmit time of the next subframe in seconds of GPS Time of Week

(TOW). After the first subframe is collected and decoded by the receiver, an approximate calculation of the receiver clock offset can be made. The receiver clock offset is the difference between GPS time and internal receiver time. The calculation is based on subframe transmit time and the approximate propagation time from the satellite signal to the receiver. The position of the satellite and receiver clock offset are used to re-initialize the seconds counter on the receiver, resulting in receiver/GPS time synchronization. The accuracy of the receiver time is expected to be within 30 milliseconds (ms) of GPS time. This initial synchronization is referred to as coarse time and is indicated by COARSE in the time status field of the **TIMESYNC** log.

#### **Fine Time**

When at least four satellites are acquired to calculate the antenna position, a more accurate estimate of the receiver clock offset is calculated. The new receiver clock offset is used to synchronize the receiver clock even closer to GPS time. This is referred to as fine time and appears as FINE or FINESTEERING in the time status field of the **TIMESYNC** log. Fine time accuracy is a function of the GPS constellation status and is influenced by external receiver RF delay. For the Standard Position Service (SPS) the time accuracy is specified as 20 ns (1 sigma) with internal compensation.

#### **Fine Clock**

An OEM7 receiver that is tracking satellites and has a FINE or FINESTEERING receiver clock state.

#### **Cold Clock**

An OEM7 receiver that needs to have its clock synchronized with the Fine receiver. It may have any clock state (except FINE or FINESTEERING) that includes UNKNOWN.

#### **Warm Clock**

An OEM7 receiver that has its clock adjusted to greater than 500 ms. Refer to the **TIME** log to view the clock offset.



The [OEM7 Commands and Logs Reference Manual](#) contains details of the logs mentioned above.

### **3.10.3 Procedures to Transfer Time**

These procedures are used to transfer time between a fine clock and a cold or warm clock GPS receiver.



When connecting two receivers to transfer time, disable responses on the COM port used to connect the receivers by issuing the following command on both receivers:

```
interfacemode comX novatel novatel none
```

Where comX is the port used on the receiver.

#### **Transfer COARSE Time (<10 ms) from a Fine Clock to a Cold Clock GPS Receiver**

1. Connect a COM, USB or Ethernet port from the fine clock receiver to the cold clock receiver (for example, COM2 on the fine clock receiver to COM3 on the cold clock receiver) as shown in *Figure 19: Transfer COARSE Time from Fine Clock to Cold Clock Receiver* on the next

page. Configure both ports to the same baud rate and handshaking configurations.

- Issue the following command to the fine clock receiver:

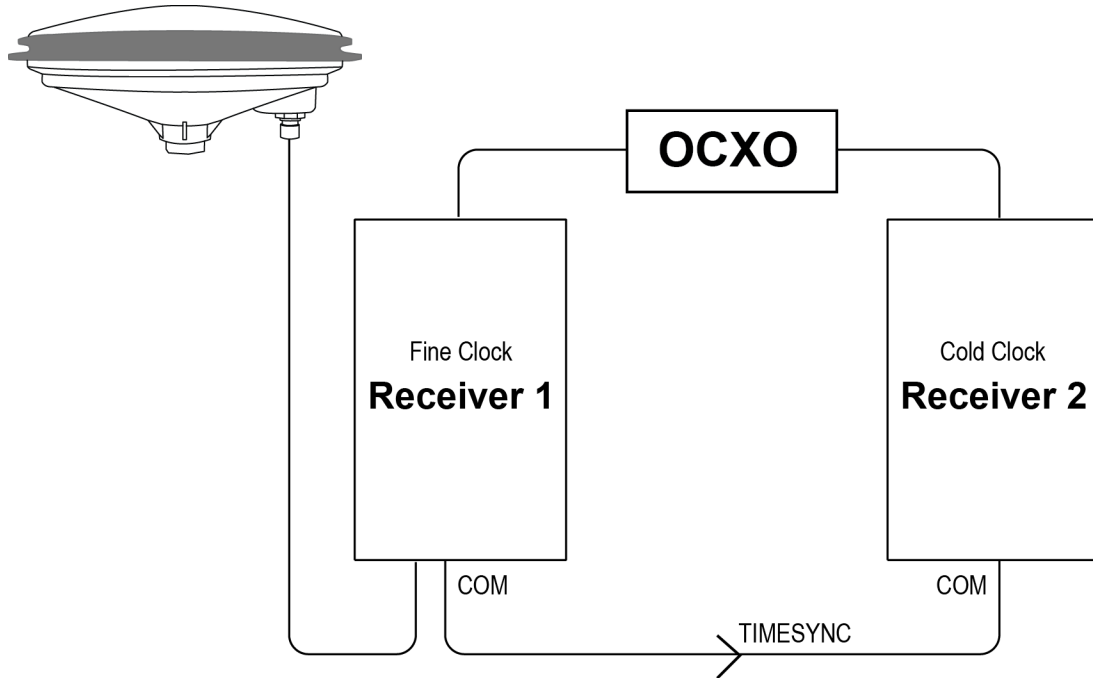
```
log com2 timesyncb ontime 1
```

- Issue the following command to the cold clock receiver:

```
adjust1pps time
```

When the cold clock receiver receives the **TIMESYNC** log, it sets its clock with a 100 ms transfer delay allowance.

**Figure 19: Transfer COARSE Time from Fine Clock to Cold Clock Receiver**



### Transfer FINE Time (<50 ns) from a Fine Clock to a Cold Clock GPS Receiver

- Connect a COM, USB or Ethernet port from the fine clock receiver to the cold clock receiver (for example, COM2 on the fine clock receiver to COM3 on the cold clock receiver), as shown in *Figure 20: Transfer FINE Time from Fine Clock to Cold Clock Receiver* on the next page. Configure both ports to the same baud rate and handshaking configurations.
- Issue the following command to the fine clock receiver:

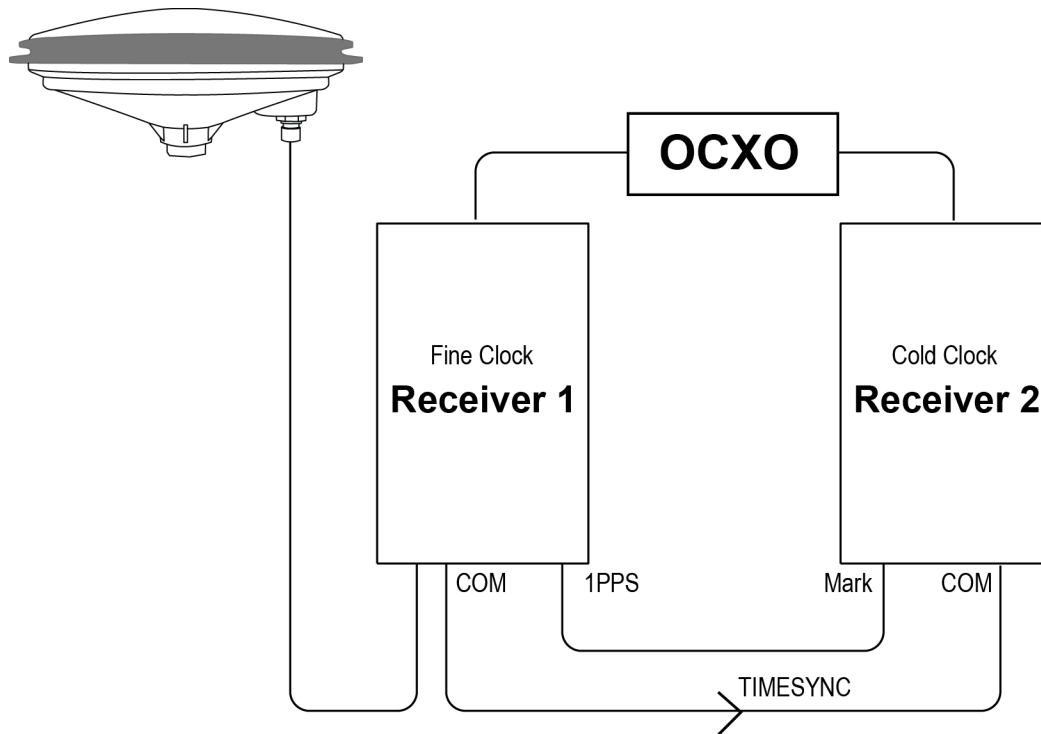
```
log com2 timesyncb ontime 1
```

- Connect the 1PPS signal of the fine clock receiver to the Mark 1 input (Event1) of the cold clock receiver.

- Issue the following command to the cold clock receiver:

```
adjust1pps markwithtime
```

When the cold clock receiver receives the 1PPS event from the fine clock receiver, it checks to see if a valid **TIMESYNC** log has arrived within 200 ms of the last 1PPS event. If so, it sets the cold clock receiver clock to the time of the fine clock receiver. See *Figure 22: 1 PPS Alignment* on page 69.

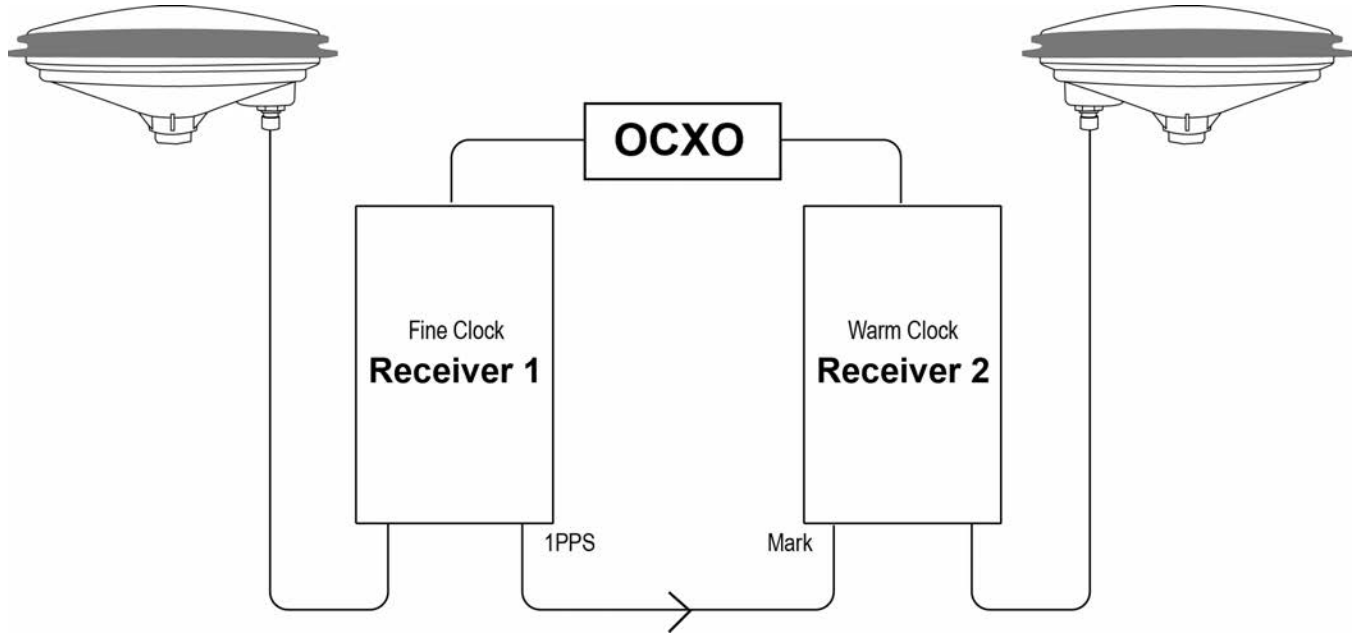
**Figure 20: Transfer FINE Time from Fine Clock to Cold Clock Receiver****Transfer FINE Time from a Fine Clock to a Warm Clock GPS Receiver**

1. Connect the 1 PPS signal of the fine clock receiver to the Mark 1 input (Event1) of the warm clock receiver as shown in *Figure 21: Transfer FINE Time from Fine Clock to Warm Clock Receiver* on the next page.
2. Issue the following command to the warm clock receiver:

```
adjust1pps mark
```

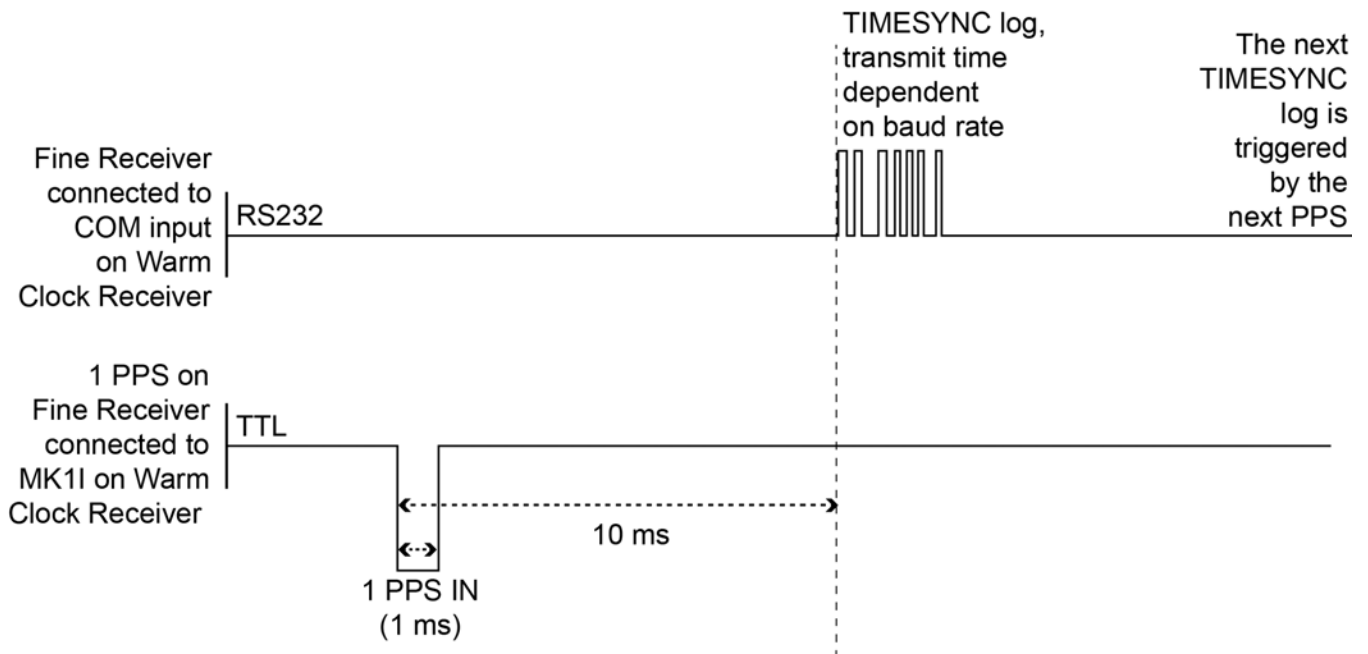
The phase of the warm clock receiver clock is adjusted by the fractional measurement of the fine clock receiver's 1 PPS mark input event. In other words, it synchronizes the warm clock receiver's 1 PPS to the incoming 1 PPS of the fine clock receiver. It does not adjust the one second TOW counter or the receiver's week number. This procedure is used to make small corrections to the warm clock receiver's clock.

**Figure 21: Transfer FINE Time from Fine Clock to Warm Clock Receiver**



If Receiver 2 is not in coarsetime, the input is ignored.

**Figure 22: 1 PPS Alignment**





The examples shown in *Figure 19: Transfer COARSE Time from Fine Clock to Cold Clock Receiver* on page 67, *Figure 20: Transfer FINE Time from Fine Clock to Cold Clock Receiver* on page 68 and *Figure 21: Transfer FINE Time from Fine Clock to Warm Clock Receiver* on the previous page are for the transfer of time. If a position is needed, the receiver must be tracking satellites and must have a valid almanac.

## 3.11 Interference Toolkit

The Interference Toolkit (ITK) feature monitors, quantifies and removes interference sources to prevent interference from impacting receiver performance.

Using the Interference Toolkit, you can monitor the Radio Frequency (RF) spectrum in a range of frequencies around the GNSS signals that are being received by the OEM7 receiver. If an interference signal is detected, information about the interference is output in the **ITDETECTSTATUS** log. More information about the interference signal can be determined by plotting the information obtained.

Signals available are model dependent. A variety of mitigation techniques are available. Contact [www.novatel.com/where-to-buy/sales-offices](http://www.novatel.com/where-to-buy/sales-offices) to activate full mitigation features.

### 3.11.1 Monitoring GNSS Signals

By default, interference detection is enabled. Detection can be disabled/enabled as needed. See *Disable/Enable Detection* on page 72 for instructions. Detected interference can be viewed and different tracking modes with possible additional filters can be applied to mitigate the interference using NovAtel Connect. Detected interference details can also be logged and analyzed using the command line interface.

There are two types of interference detection available, Spectral Analysis Detection and Statistical Analysis Detection.



NovAtel recommends using the default settings for Interference Toolkit whenever possible.



NovAtel Connect 2.0 or greater is required to use Interference Toolkit functionality. Download NovAtel Connect from [www.novatel.com/novatel-connect](http://www.novatel.com/novatel-connect).

### Spectral Analysis Detection

Spectral Analysis Detection is focused on in-band, near-band, and strong out-band interference detection.

OEM7 uses receiver gain calibration data that is stored in receiver memory at receiver start-up. The calibration data is used to estimate the antenna gain before the receiver, as well as generate interference free spectrum reference for spectral analysis detection. The receiver assumes that the receiver is in an interference free environment during start-up and the antenna is connected to the receiver and powered up.



When using the Interference Toolkit, the receiver must be reset when the GNSS antenna is connected or disconnected.



If a known interference source is present at the receiver start up, it's strongly recommended that users enter the calibrated receiver input gain using the **RFINPUTGAIN** command.

## Measuring the RF Input Gain



This section is intended for advanced users.

The **RFINPUTGAIN** command allows users to enter a more accurate receiver input condition, which is considered as a calibrated receiver input condition, and is used for interference detection. This command supports different values for L1, L2, L5, and L-Band and is recommended when there is a known strong interference present at receiver start up.

To calibrate the receiver input level, use a standard spectrum analyzer to measure the receiver input noise density in dBm/Hz. Make sure the pre-amplifier is turned on in Spectrum Analyzer under "Amplitude". Place the Marker around L1, L2, L5, or L-Band frequency region and select "noise density" under "Marker Function".

$RFINPUTGAIN = \text{Receiver Input Noise Density (dBm/Hz)} - \text{Typical Thermal Noise KT of } -174\text{dBm/Hz,}$

where:

$K = 1.38E-23\text{w-sec/K}$

$T = 290\text{ k.}$

For example, if the receiver input noise density measured at L1 is -144dBm/Hz,

$RFINPUTGAIN = -144 - (-174) = 30\text{dB for L1 path.}$

Alternatively, if a spectrum analyzer is not available, the RFINPUTGAIN can be obtained using the cascaded RF gain before the receiver plus LNA noise figure (NF), including LNA gain in antenna, in-line amplifier gain (if applicable), RF cable or distribution loss prior to receiver input connector. A typical GNSS active antenna with reasonable quality has a noise figure of ~2dB.

$RFINPUTGAIN = \text{Cascaded Gain before receiver} + \text{LNA NF}$

For example, if system cumulative gain measured before receiver is ~25dB, and LNA NF is around 2dB, the RFINPUTGAIN = 27dB.

```
RFINPUTGAIN L1 27
```

```
RFINPUTGAIN L2 27
```

```
RFINPUTGAIN L5 27
```

```
RFINPUTGAIN LBand 27
```

## Statistical Analysis Detection

Statistical Analysis Detection is focused on out of band interference detection. It is supplementary to the Spectrum Analysis Detection and is useful when interference is outside the

analog passband of the receiver and creating distortion that may not be visible to Spectrum Analysis Detection until the interference is very strong.

The Statistical Analysis Detection is designed as a sensitive detection tool. Out of band mitigation does not impose much penalty when enabled and it brings awareness to unintentional interferences next to GNSS operations.



Spectral Analysis Detection takes precedent over Statistical Analysis Detection. If the same interference is detected by both detectors, only Spectral Analysis Detection is used to report the interference status.

### 3.11.2 Disable/Enable Detection

The interference detection feature can be enabled/disabled from any command line or the command line within NovAtel Connect using the **ITDETECTCONFIG** command.

To disable interference detection, enter:

```
ITDETECTCONFIG none
```

To enable interference on all RF paths, enter :

```
ITDETECTCONFIG all
```

Interference detection can also be enabled on individual RF paths. See the **ITDETECTCONFIG** command for details.

### 3.11.3 Monitoring Signals Using a Command Line

The **ITDETECTSTATUS** log lists all detected interference signals. For interference detected by spectral analysis, the log also provides the center frequency and bandwidth of the interference signal. With this information, a filter can be configured to mitigate the interference.



Due to the high volume of data, a higher bandwidth medium, such as USB or Ethernet, is recommended when monitoring signals using the Interference Toolkit.

#### Example:

```
LOG ITDETECTSTATUS onchanged

#ITDETECTSTATUSA,USB2,0,74.0,FINESTEERING,1982,430605.267,0200c000,
7fdb,32768;3,
L1,STATISTICANALYSIS,-0.718,29.167,0.126,12.797,00000000,00000000,
00000000,
L2,SPECTRUMANALYSIS,1249.961,71.191,-56.769,-132.907,00000000,
00000000,00000000,
L2,SPECTRUMANALYSIS,1289.512,1.978,-75.967,-138.493,00000000,
00000000,00000000*5e83b175
```

In the above example, there are three interference signals detected:

- Out of band interference near L1 (STATISTICANALYSIS)
- Interference in the L2 band at 1249.961 MHz
- Interference in the L2 band at 1289.512 MHz



To view details about the signals that are being received by the OEM7 receiver and determine if there is an interference signal within the GNSS signals, use the **ITSPECTRALANALYSIS** command to enable and configure the spectral analysis. The spectrum can then be viewed by plotting the PSD samples in the **ITPSDFINAL** log. NovAtel Connect can also be used to view the spectrum. See *Monitoring Signals Using NovAtel Connect* below.

**Example:**

```
ITSPECTRALANALYSIS PREDECIMATION GPSL1 200 2K 1 1
LOG ITPSDFINAL onnew
```

When logged, incoming signal information is collected at the rate specified in the **ITSPECTRALANALYSIS** command.



Pre-decimation – Raw analog-to-digital converter signals.

Post-decimation — Analog-to-digital converted signal for the specific signal encoder path. This gives a narrower view of the incoming signal.

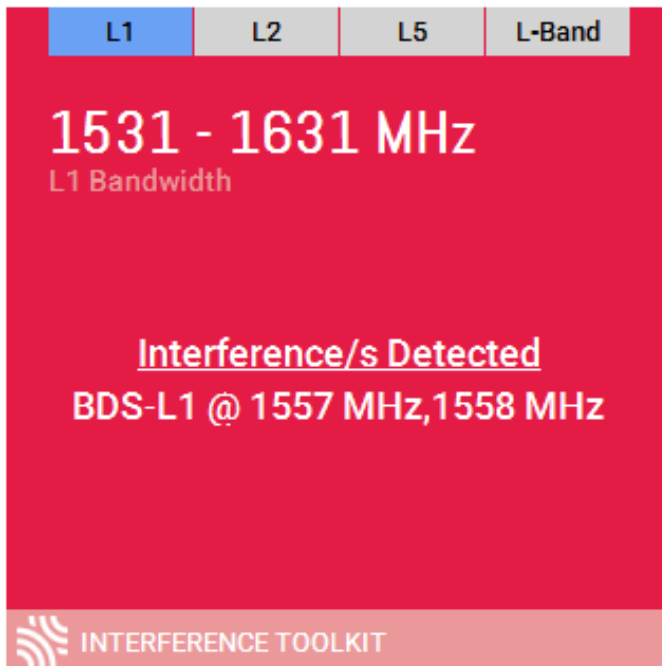
### 3.11.4 Monitoring Signals Using NovAtel Connect



Due to the high volume of data, a higher bandwidth medium, such as USB or Ethernet, is recommended when monitoring signals using the Interference Toolkit.

Start NovAtel Connect and open a connection to the OEM7 receiver.

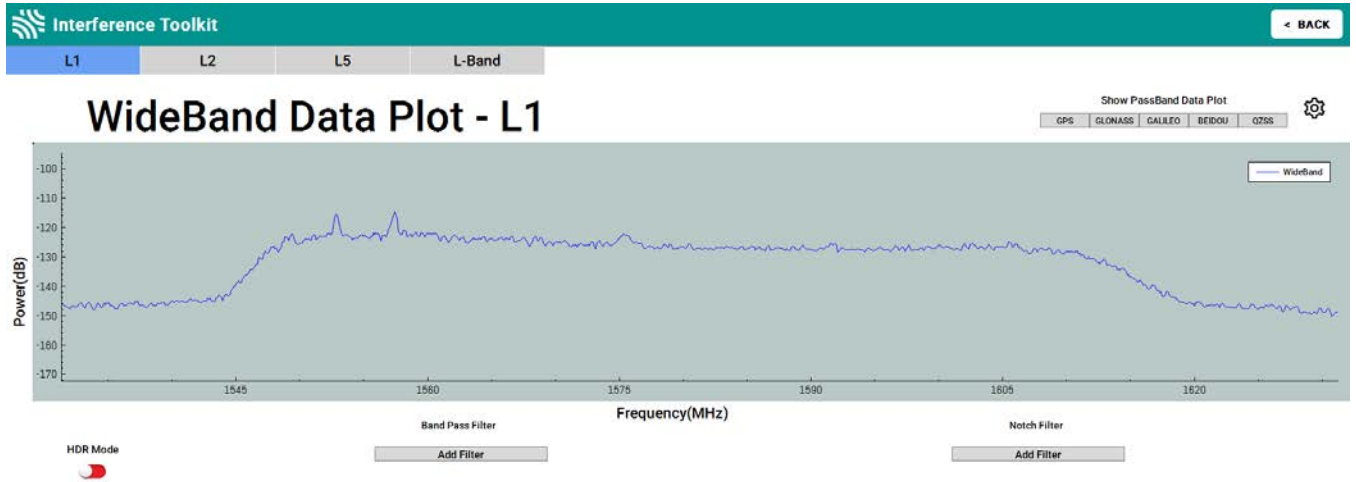
Scroll down to the Interference Toolkit and double click on the Interference Toolkit tile.



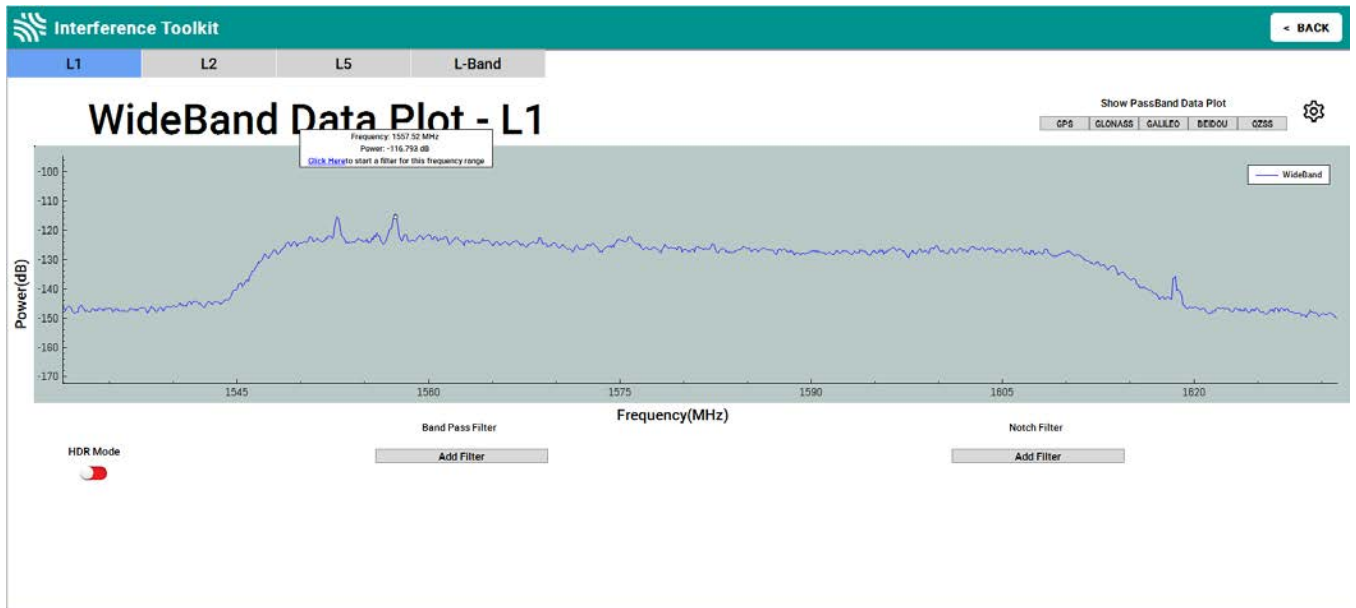


The tile displays red when interference is detected; displays green when no interference is present.

The Interference Toolkit window opens. The following example shows a typical signal.



Placing the cursor over any place in the signal band will display additional information regarding that location in the signal band.



### 3.11.5 Remove Interference Signals

If an interference signal is present, the Interference Toolkit can reduce or eliminate the impact on GNSS tracking using the programmable High Dynamic Range (HDR), Bandpass or Notch filters.

Contact [www.novatel.com/where-to-buy/sales-offices](http://www.novatel.com/where-to-buy/sales-offices) to obtain mitigation functionality.

### High Dynamic Range Mode

The High Dynamic Range (HDR) mode enables special signal processing to remove distortions from the spectrum, providing a cleaner signal. This optimizes the Automatic Gain Control (AGC) to prevent interfering signals from drowning out the GNSS signals. HDR mode works well against wide band and out-of-band interferers. HDR mode can be combined with bandpass and notch filters, but does draw more power.

To configure HDR mode, use the **ITFRONTENDMODE** command. HDR mode can also be enabled using NovAtel Connect.

### Notch Filter

The Interference Toolkit notch filter reduces the signal power in a narrow frequency band. This type of filter is useful for reducing the signal power of a single, narrow band interference signal. Note that the narrowest possible filter should be used to maintain the maximum amount of over-all signal power.

To configure a notch filter, use the **ITPROGFILTCONFIG** command. A notch filter can also be configured using NovAtel Connect.

### Bandpass Filter

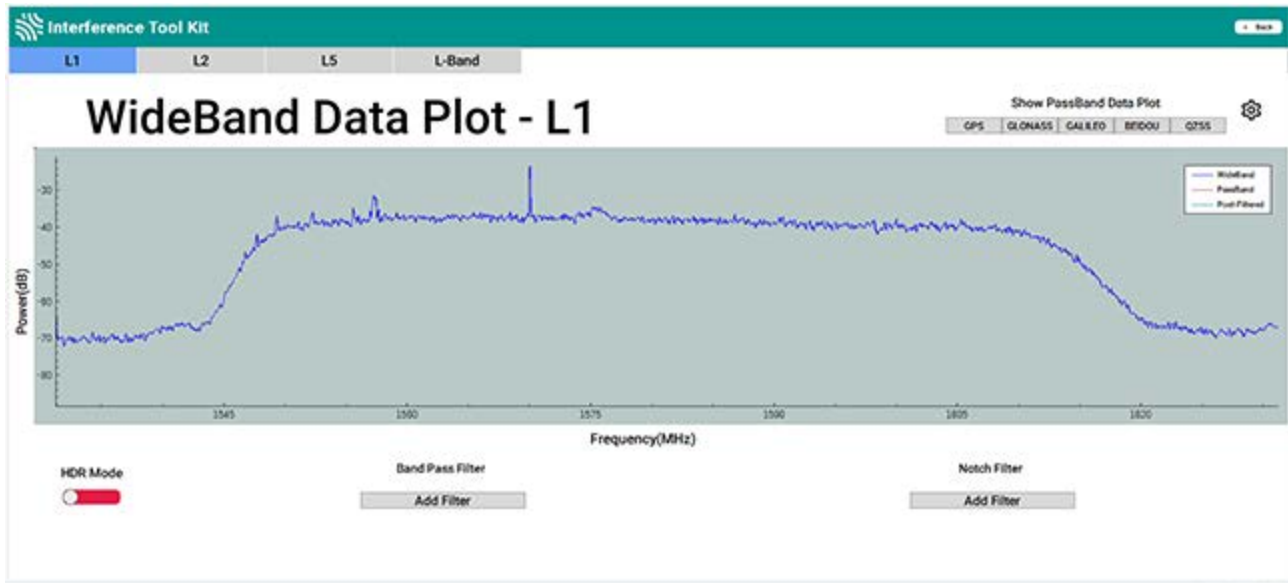
The Interference Toolkit bandpass filter reduces the signal power of all incoming signals at the upper and lower end of the GNSS signal band starting at the requested cut-off frequency. This type of filter is good for reducing single or multiple interference signals at the edges of the signal band.

When a bandpass filter is applied to this signal, the upper and lower ends of the signal band are filtered out to reduce the signal power of the interference signal.

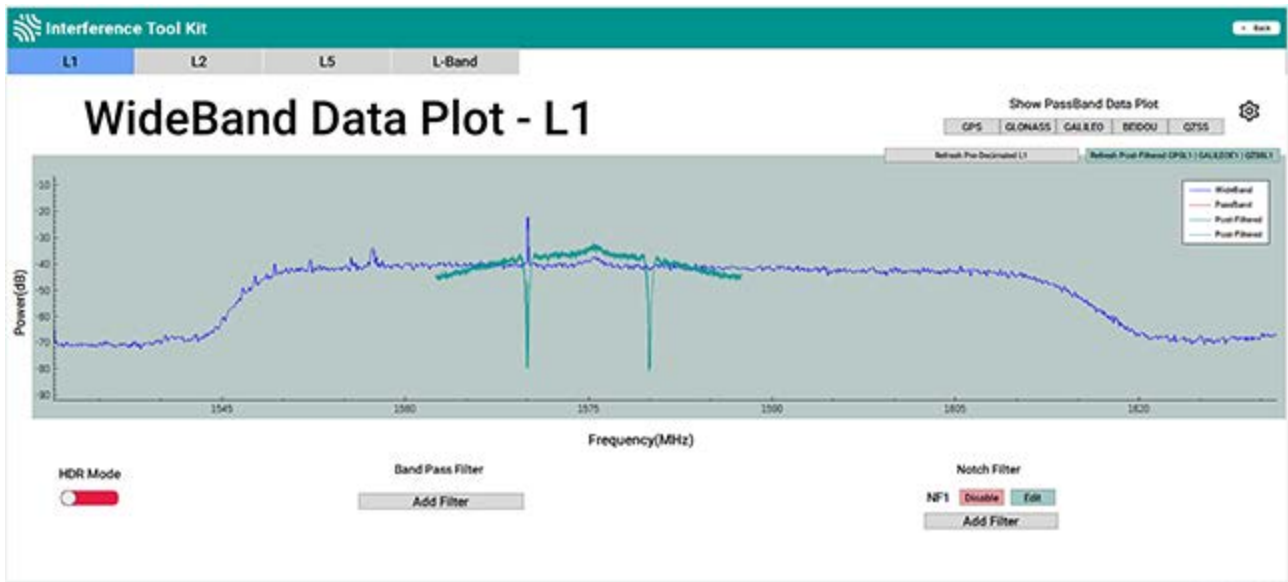
To configure a bandpass filter, use the **ITPROGFILTCONFIG** command or the **ITBANDPASSCONFIG** command. A bandpass filter can also be configured using NovAtel Connect.

### Example of a Notch Filter

The following example shows interference at 1750 in the signal band.



The following example shows post filtering with interference.



### Interference Toolkit Commands and Logs

The following are the commands and logs used by the Interference Toolkit to monitor, apply filters and mitigate interference. Commands and logs with the  $\checkmark$  are available by default. Contact [www.novatel.com/where-to-buy/sales-offices](http://www.novatel.com/where-to-buy/sales-offices) to activate full mitigation features.

Commands		
ITBANDPASSCONFIG		Configures a bandpass filter on the receiver.
ITDETECTCONFIG	$\checkmark$	Enables or disables automatic interference detection on the receiver.

Commands		
ITFRONTENDMODE		Configures the front end mode for each RF path to use the default tracking mode or change to High Dynamic Range (HDR) mode.
ITPROGFILTCONFIG		Configures filtering on the receiver to be either a notch filter or a bandpass filter.
ITSPECTRALANALYSIS	√	Configures and enables spectral analysis on the receiver.

Logs		
ITBANDPASSBANK		Provides the allowable bandpass filter configurations.
ITDETECTSTATUS	√	Lists all of the interference detected on the paths on which automatic interference detection has been enabled.
ITFILTABLE		Summarizes the filter configuration for each frequency and indicates which bandpass or notch filters are enabled and configured.
ITPROGFILTBANK		Provides the allowable programmable filter configurations.
ITPSDFINAL	√	Provides the power spectral density information of the specified signal path.

## 3.12 Logging and Retrieving Data Overview

Logs can be directed to any of the receiver communication ports and can be automatically generated at regular intervals or when new or changed data becomes available.

Data can be collected using NovAtel Connect or NovAtel Web User Interface. Refer to the Help available from within NovAtel Connect for comprehensive logging instructions. Refer to the online OEM7 documentation ([docs.novatel.com/OEM7](https://docs.novatel.com/OEM7)) for information about logging using NovAtel Web User Interface.



NovAtel Connect version 2.0 or greater is required for OEM7 receivers. Download the latest NovAtel Connect software and documentation from [www.novatel.com/novatel-connect](https://www.novatel.com/novatel-connect).

### 3.12.1 Pass-Through Logging

The pass-through logging feature enables the GNSS receiver to redirect any ASCII or binary data that is input at a specified COM port or USB port, to any specified receiver COM or USB port. This capability, in conjunction with the SEND command, allows the receiver to perform bidirectional communications with other devices such as a modem, terminal or another receiver.

There are several pass-through logs available on OEM7 receivers for logging through serial ports. Refer to the PASSCOM logs in the [OEM7 Commands and Logs Reference Manual](#) for details.

### 3.12.2 Saving Logs to a File

To save log data, log requests are sent to the FILE port (for example, LOG FILE BESTPOS ONTIME 1). Before the logs sent to the FILE port can be saved in a file, the file must be created (opened) on the file system using the FILECONFIG OPEN command. The log file will open when the active file media is ready and has sufficient space. The active file media is configured using the **FILEMEDIACONFIG** command.

#### File Naming

When a file is opened, the file name is generated based on the following format:

<PSN>\_<INDEX>.LOG

where:

- <PSN> is the product serial number of the enclosure
- <INDEX> is a number from 1 to 511.

The lowest number that produces an unused file name is selected. If there is no such number available, the **FILESTATUS** log will report an error.

The number is not zero-padded (i.e. the sequence is as follows: 1,2, ... ,9,10,11,12, ... ,99,100, ... , 510,511).

When a file is closed (FILECONFIG CLOSED) and the receiver has a valid time, the file is renamed based on the following format:

<PSN>\_<UTC Date>\_<UTC Time>.LOG

where:

- <PSN> is the product serial number of the enclosure
- <UTC\_Date> is the UTC date in the format YYYY-MM-DD
- <UTC\_Time> is the UTC time in the format HH-MM-SS

Example file name: NOV12001200A\_2017-01-10\_12-14-34.LOG

When a file is closed, but the receiver does not have a valid time, the file is left with its automatically generated name.



- The file is created before the **FILECONFIG** command returns a response.
- Only logs that are published after the log file is open are recorded.
- Only one log file can be open at a time.
- Logs requested to the FILE port are still produced even if the log file is closed, however the logs are not recorded. (This is similar to requesting logs to COM4 when there is not connection to COM4.) If a new log file is opened, recording of the previously requested logs continues with the new file.

#### File Rotation

When collecting a large amount of log data over an extended time period, the maximum size and duration for a log file can be configured using the **FILEROTATECONFIG** command.

If the file duration is set, the log file is closed after the specified duration and a new log file is created. If the file size is set, the log file is closed after the file reaches the specified size and a

new log file is created. New log files are created and closed until the file system runs out of free space or logging is stopped. If the **OVERWRITE** mode has been set, the oldest file will be deleted in order to make room for the new file so data logging can continue.

There is no data loss during the file rotation process and individual logs within the file are not spread between log files.

For more information about configuring file rotation, refer to the **FILEROTATECONFIG** command in the [OEM7 Commands and Logs Reference Manual](#).



The maximum size of a log file is 4 GB. Once this size is reached, the log file will close. Another log file will be created to continue logging.

### 3.12.3 Logging to Internal Memory

When the file media is set to internal memory (FILEMEDIACONFIG INTERNAL\_FLASH), logs sent to the FILE port are saved on internal memory.



For information about logging to internal memory using the PwrPak7 Log button, see *Logging Using the Log Button* on the next page.



Before powering off the PwrPak7 or using the **RESET** command, use the FILECONFIG CLOSE command, or press the Log button, to close the log file.



NovAtel Web UI is the recommended method for configuring logging to internal memory. Refer to the Web UI section of the online OEM7 User Documentation ([docs.novatel.com/OEM7](https://www.novatel.com/OEM7)) for information about configuring logging using the NovAtel Web UI.

### Logging to Internal Memory using the Command Line

To log to internal memory:

1. Set the file media to internal memory (this is the default).

```
FILEMEDIACONFIG INTERNAL_FLASH
```

2. Open a log file on internal memory.

```
FILECONFIG OPEN
```

The **LOG** LED begins to blink to show that a log file is open on internal memory.

3. Use the LOG command to start collecting logs to the file on internal memory. The logs must use the FILE port. For example:

```
LOG FILE VERSIONA
```

```
LOG FILE BESTPOSA ONTIME 1
```

Enter a LOG command for each log you want to collect.

4. Wait until the desired data has been collected.
5. Enter the following command to stop data collection and close the log file.

```
FILECONFIG CLOSE
```

The **LOG** LED changes to a solid color to indicate that the PwrPak7 is no longer logging to internal memory.

### 3.12.4 Logging Using the Log Button

The PwrPak7 Log button is used to start and stop log collection to a file on internal memory.

Pressing the Log button results in the following behavior:

- If the logging file is closed, the file will be opened (analogous to issuing the FILECONFIG OPEN command). Any logs configured to be sent to the FILE port will begin to be collected in a new file.
- If the logging file is open, the file will be closed (analogous to issuing the FILECONFIG CLOSE command).



Before powering off the PwrPak7 or using the **RESET** command, use the **FILECONFIG** command, or press the Log button, to close the log file.

### Logging using the Log Button

The file media must be available to the receiver when pressing the Log button.

1. Ensure that a computer is not connected to the TRANSFER port.
2. Wait until the PwrPak7 mounts the file media.

Ensure that the **LOG** LED is solid green.

Alternatively, the mount status can be checked using the **FILESYSTEMSTATUS** log:

```
LOG FILESYSTEMSTATUSA ONCHANGED

#FILESYSTEMSTATUSA,COM2,0,22.0,UNKNOWN,0,4.893,02440020,143c,32768;2,INTERNAL_FLASH,MOUNTING,0,"",USBSTICK,UNMOUNTED,0,""

#FILESYSTEMSTATUSA,COM2,0,18.0,UNKNOWN,0,4.893,02440020,143c,32768;2,INTERNAL_FLASH,MOUNTED,0,"",USBSTICK,UNMOUNTED,15471912,""
```

3. Press and release the Log button.
4. When you are finished collecting logs, press and release the Log button.  
File logging stops and the log file is closed.

The log file is now available for access.

### Example: Collecting Logs Using the Log Button

The following example shows how to collect the BESTPOS log on internal memory using the Log button.

1. Ensure that the PwrPak7 TRANSFER port is not plugged into a computer.
2. Press the Log button to activate file logging.



3. On any COM port, enter the following command.

```
LOG FILE BESTPOSA ONTIME 1
```



Other logs can also be collected by logging them to the FILE port.

4. When log collection is finished, press the Log button to stop capturing logs to file.
5. The **File** LED changes to solid green to indicate that logging has stopped.

### 3.12.5 Transferring Files from Internal Memory to a USB Stick

Logs can be saved to a file on the PwrPak7 internal memory. After the logs have been collected and the log file closed, the logs can be retrieved by transferring the files from internal memory to a USB stick.



NovAtel recommends using a Micro A to USB stick adapter, such as Tensility 10-00649 or equivalent, to connect a USB stick to the PwrPak7 TRANSFER port.



To save to a file on internal memory, the internal memory must be selected as the file media using the **FILEMEDIACONFIG** command.



USB sticks used with the PwrPak7 must be formatted as FAT32.

If the USB stick is formatted incorrectly, or corrupted, the **TRANSFER** LED will flash red for three seconds and then stay solid red. To correct the issue, use a computer to reformat the USB stick as FAT32.

For more information about the USB sticks for the PwrPak7, refer to *USB Devices Supported* on page 161.



Before powering off the PwrPak7 or removing the USB stick from the PwrPak7, use the **USBSTICKEJECT** command to unmount the USB stick.

### Automatic File Transfer

When automatic file transfer is enabled, all of the files stored on the PwrPak7 internal memory are automatically transferred to a USB stick when the USB stick is inserted.

To enable automatic file transfer, enter one the following two commands.

```
FILEAUTOTRANSFER COPY
```

```
FILEAUTOTRANSFER MOVE
```

If **FILEAUTOTRANSFER** is set to **COPY**, the files are transferred into a folder on the USB stick named with the enclosure PSN (e.g. BMHR15470145U) and the files are retained on internal memory.

If **FILEAUTOTRANSFER** is set to **MOVE**, the files are transferred into a folder on the USB stick named with the enclosure PSN and the files are deleted from the internal memory if the transfer is successful.

Use the **FILETRANSFERSTATUS** log to monitor the progress of the file transfer. When the file transfer is complete, enter the **USBSTICKEJECT** command before removing the USB stick from the PwrPak7. The **FILESYSTEMSTATUS** log indicates the *USBSTICK UNMOUNTED* status when it is safe to physically remove the USB stick. This may take up to 10 seconds.



Removing the USB stick before it is unmounted may corrupt the data files.

To disable automatic file transfer, enter the following command.

```
FILEAUTOTRANSFER OFF
```

For more information, see the **FILEAUTOTRANSFER** command in the [OEM7 Commands and Logs Reference Manual](#).

## Manual File Transfer

Use a manual file transfer to move or copy a single file, or all of the files, from internal memory to a USB stick.

1. Insert a USB stick into the PwrPak7 TRANSFER USB port.
2. If moving or copying a single file, use the **FILELIST** command to get list of the files stored on internal memory. Note that the file media must be set to INTERNAL\_FLASH (see the **FILEMEDIACONFIG** command) to view the files on internal memory.
3. Enter one of the following commands to transfer the file or files.
  - To transfer all of the files from internal memory to the USB stick and leave the files on internal memory, enter:

```
FILETRANSFER COPY ALL
```

- To transfer all of the files from internal memory to the USB stick and delete the files from internal memory after the successful transfer, enter:

```
FILETRANSFER MOVE ALL
```

- To transfer a single file from internal memory to the USB stick and leave the file on internal memory, enter the following command. In the example below, **BMHR16460033T\_2017-3-16\_21-18-48.log** is the name of the file being copied.

```
FILETRANSFER COPY BMHR16460033T_2017-3-16_21-18-48.log
```

- To transfer a single file from internal memory to the USB stick and delete the file from internal memory, enter the following command. In the example below, **BMHR16460033T\_2017-3-16\_21-18-48.log** is the name of the file being moved.

```
FILETRANSFER MOVE BMHR16460033T_2017-3-16_21-18-48.log
```

For more information, see the **FILETRANSFER** command in the [OEM7 Commands and Logs Reference Manual](#).

4. Use the **FILETRANSFERSTATUS** log to monitor the progress of the file transfer.
5. When the file transfer is complete, enter the **USBSTICKEJECT** command to unmount the

USB stick.

6. Use the **FILETRANSFERSTATUS** log to check for the *USBSTICK UNMOUNTED* status.
7. When the USB stick is unmounted, remove it from the PwrPak7.

### Cancel a File Transfer

To cancel a file transfer, enter the following command.

```
FILETRANSFER CANCEL
```

This command will cancel an automatic (FILEAUTOTRANSFER) or a manual (FILETRANSFER) transfer.

### 3.12.6 Access Internal Memory with a Computer

The PwrPak7 has 16 GB of internal Flash memory. This memory is formatted as FAT32 with a cluster size of 16 kB.

When a computer is connected to the TRANSFER port on a PwrPak7, the computer can access the internal memory on the PwrPak7. If the internal memory is not in use (FILECONFIG CLOSE), control of the internal memory is transferred from the PwrPak7 to the computer. If the internal memory is being used for logging (FILECONFIG OPEN), control is not transferred to the computer. This prevents an interruption of the logging. To allow the computer to access the internal memory, stop logging to internal memory (FILECONFIG CLOSE).

When the computer is disconnected from the TRANSFER port, control of the internal memory is transferred back to the PwrPak7. The PwrPak7 then checks the file system on the internal memory for errors. If any errors are found, the PwrPak7 attempts to correct them. This may result in files being placed in the *Lost and Found* folder in the root of the internal memory.

To reduce the likelihood of internal memory corruption or data loss, the following is recommended:

1. Always use the *Eject* option on your computer before disconnecting the USB cable from the PwrPak7.
2. Before powering off the PwrPak7, use the FILECONFIG CLOSE command to ensure there is no activity on the internal memory when the power is lost.

### Repair Errors on the Internal Memory

The internal memory can become corrupt and inaccessible to the PwrPak7. This can happen if there is a sudden power loss when the PwrPak7 is transferring files from the internal memory. This can also happen if there is improper use of the internal memory when connected to a computer.

The PwrPak7 will attempt to repair any errors found on the internal memory. This may result in files being placed in the *Lost and Found* folder in the root of the internal memory. In the case of severe errors, the PwrPak7 may not be able to repair the errors and preserve user data. When this occurs, the **FILESYSTEMSTATUS** log reports an **ERROR** status for INTERNAL\_FLASH and the **LOG** LED is solid red. There are two ways to recover from this condition:

1. Connect a computer to the TRANSFER port on the PwrPak7 and use computer-based tools to repair the PwrPak7 internal memory.



When using computer-based disk recovery utilities, ensure the internal memory remains formatted as FAT32 with a cluster size of 16 kB after the repair.

2. Use the PwrPak7 interface to reformat the internal memory. This results in a complete loss of data on the internal memory.
  - a. Disconnect the computer from the TRANSFER port on the PwrPak7.
  - b. From any COM port on the PwrPak7, check the **FILESYSTEMSTATUS** log.

```
log filesystemstatusa onchanged
```
  - c. Wait until the status of the INTERNAL\_FLASH reports ERROR and the LOG LED is solid red.
  - d. Use the **MEDIAFORMAT** command to reformat the internal memory.

```
MEDIAFORMAT INTERNAL_FLASH
```
  - e. Check the status of the internal memory in the **FILESYSTEMSTATUS** log.

When the INTERNAL\_FLASH reports MOUNTED and the LOG LED is solid green, the internal memory is ready for use.

### 3.13 Additional Features and Information

The following sections contain information on additional features of the OEM7 receivers.

- *Strobes* below

#### 3.13.1 Strobes

OEM7 receivers have inputs and outputs, referred to as strobes, that provide status and synchronization signals. Not all strobes are provided on all receivers. For detailed information about OEM7 receiver strobes, see:

- *PwrPak7 Strobe Specifications* on page 145

## Chapter 4 Built-In Status Tests

The Built-In Status Test monitors system performance and status to ensure the receiver is operating within specifications. The test detects an exceptional condition and informs the user through one or more indicators. The receiver status system is used to configure and monitor the indicators:

1. Receiver status word (included in the header of every message)
2. RXSTATUSEVENT log
3. RXSTATUS log

When an unusual and non-fatal event occurs (for example, there is no valid position solution), a bit is set in the receiver status word. Receiver operation continues normally. When the event ends (for example, when there is a valid position solution), the bit in the receiver status word is cleared.

When a fatal event occurs (for example, a receiver hardware failure), a bit is set in the receiver error word, part of the **RXSTATUS** log, to indicate the cause of the problem. Bit 0 is set in the receiver status word to show that an error occurred. An **RXSTATUSEVENT** log is generated on all ports to show the cause of the error. Receiver tracking is disabled but command and log processing continues to allow error diagnosis. Even if the source of the error is corrected, the receiver must be reset to resume normal operation.

These two scenarios describe factory default behavior. These behaviors can be customized to better suit an individual application. RXSTATUSEVENT logs can be disabled completely with the **UNLOG** command. RXSTATUSEVENT logs can be generated when a receiver status bit is set or cleared with the **STATUSCONFIG SET** and **STATUSCONFIG CLEAR** commands. Bits in the receiver status word can also be promoted to act like error bits with the **STATUSCONFIG PRIORITY** command.

### 4.1 Receiver Status Word

The receiver status word indicates the current status of the receiver. This word is found in the header of all logs and in the **RXSTATUS** log. In addition, the receiver status word is configurable.

The importance of the status bits can be determined with priority masks. For receiver status, setting a bit in the priority mask causes the condition to trigger an error. The error causes the receiver to idle all channels, turn off the antenna and disable the RF hardware, just like it would if a bit in the receiver error word is set. Setting a bit in an Auxiliary Status priority mask causes the condition to set the bit in the receiver status that corresponds to the auxiliary status.

Use the **STATUSCONFIG** command to configure the various status mask fields in the **RXSTATUS** log. Use the masks to specify whether various status fields generate errors or event messages when set or cleared.

Refer to the **RXSTATUS** log, **RXSTATUSEVENT** log and **STATUSCONFIG** command in the [OEM7 Commands and Logs Reference Manual](#) for more detailed descriptions of these messages.

### 4.2 RXSTATUSEVENT Log

The **RXSTATUSEVENT** log is used to output event messages, as indicated in the **RXSTATUS** log.

On start up, the OEM7 receiver is set to log **RXSTATUSEVENTA ONNEW** on all ports. You can remove this message using the **UNLOG** command.

Refer to the **RXSTATUSEVENT** log in the [OEM7 Commands and Logs Reference Manual](#) for log and command details. for a more detailed description of this log.

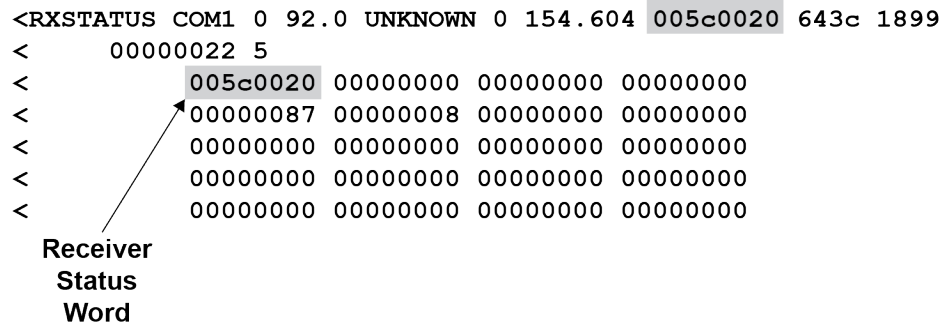
### 4.3 RXSTATUS Log

The Receiver Status log (RXSTATUS) provides system status and configuration information in a series of hexadecimal words.

#### 4.3.1 Status Word

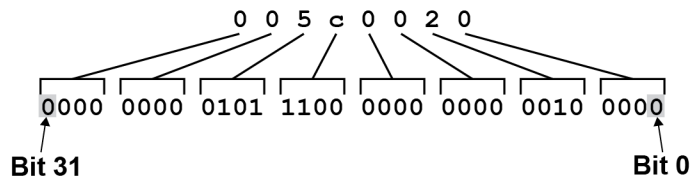
The status word is the third field after the header, as shown in the example in *Figure 23: Location of Receiver Status Word* below.

**Figure 23: Location of Receiver Status Word**



Each bit in the status word indicates the status of a specific receiver condition or function. If the status word is 00000000, the receiver is operating normally. The numbering of the bits is shown in *Figure 24: Reading the Bits in the Receiver Status Word* below.

**Figure 24: Reading the Bits in the Receiver Status Word**



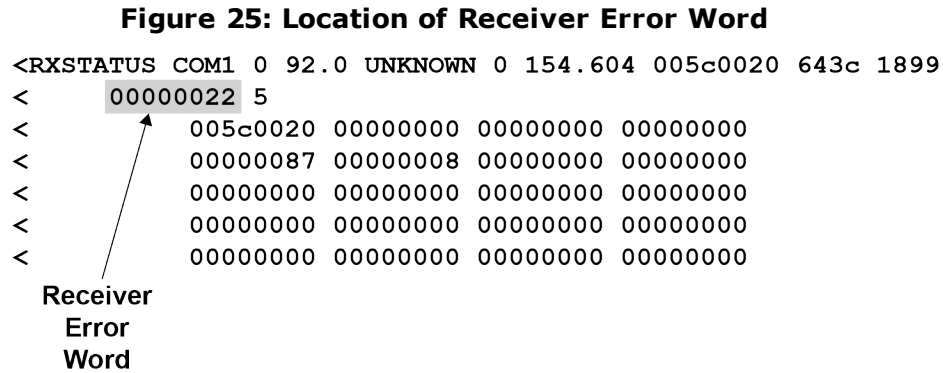
If the receiver status word indicates a problem, see *Examining the RXSTATUS Log* on page 110.

#### 4.3.2 Error Word

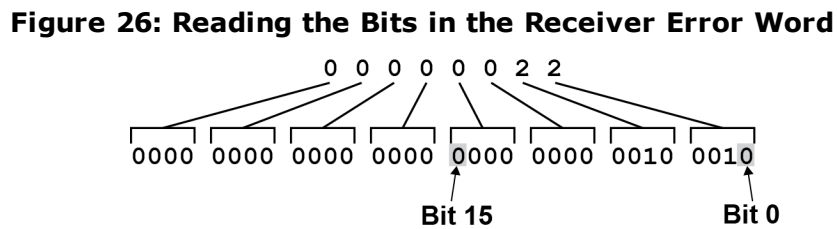
The error field contains a 32-bit word. Each bit in the word is used to indicate an error condition. Error conditions may result in damage to the hardware or erroneous data, so the receiver is put into an error state. If any bit in the error word is set, the receiver broadcasts the **RXSTATUSEVENT** log on all ports (unless the user has unlogged it), idles all channels, turns the antenna off and disables the RF hardware. To override the error state, reset the receiver.

The receiver can be configured to generate event messages triggered by status conditions. Receiver Error words automatically generate event messages. These event messages are output in the **RXSTATUSEVENT** log (see also *Set and Clear Mask for all Status Code Arrays* on page 88).

The error word is the first field after the log header in the **RXSTATUS** log, as shown in the example in *Figure 25: Location of Receiver Error Word* below.



*Figure 26: Reading the Bits in the Receiver Error Word* below shows an example of a receiver error word.



Refer to the **RXSTATUS** log and **RXSTATUSEVENT** log in the [OEM7 Commands and Logs Reference Manual](#) for more detailed log descriptions. If the receiver error word indicates an error, refer to *Examining the RXSTATUS Log* on page 110.

### 4.3.3 Status Code Arrays

There are currently 5 status code arrays:

- receiver status word
- auxiliary 1 status
- auxiliary 2 status
- auxiliary 3 status
- auxiliary 4 status

Each status code array consists of four 32-bit words (the status word, a priority mask, a set mask and a clear mask). The status word is similar to the error word, with each of the 32 bits indicating a condition. The priority mask words are used to modify the behavior caused by a change in one of the bits in the associated status words. Each bit, in any mask, operates on the bit in the same position in the status word. For example, setting bit 3 in the priority mask changes the priority of bit 3 in the status word.

**Figure 27: Status Code Arrays**

```

<RXSTATUS COM1 0 92.0 UNKNOWN 0 154.604 005c0020 643c 1899
< 00000022 5
< 005c0020 00000000 00000000 00000000 ← Receiver Status
< 00000087 00000008 00000000 00000000 ← Auxiliary 1 Status
< 00000000 00000000 00000000 00000000 ← Auxiliary 2 Status
< 00000000 00000000 00000000 00000000 ← Auxiliary 3 Status
< 00000000 00000000 00000000 00000000 ← Auxiliary 4 Status

```

↑
↑
↑
↑

**Status Word**
**Priority Mask**
**Set Mask**
**Clear Mask**

#### 4.3.4 Receiver Status Code

The receiver status word is included in the header of all logs. It has 32 bits that indicate certain receiver conditions. If any of these conditions occur, a bit in the status word is set. Unlike the error word bits, the receiver continues to operate, unless the priority mask for the bit has been set. The priority mask bit changes the bit in the receiver status word into an error bit. Anything that results from an error bit becoming active also occurs if a receiver status and its associated priority mask bits are set.

#### 4.3.5 Auxiliary Status Codes

The auxiliary status codes are only in the **RXSTATUS** log. The four arrays that represent the auxiliary status codes indicate the receiver state for information purposes only. The events represented by these bits typically do not cause receiver performance degradation. The priority mask for the auxiliary codes does not put the receiver into an error state. Setting a bit in the auxiliary priority mask results in the corresponding bit in the receiver status code to be set if any masked auxiliary bit is set. Bit 31 of the receiver status word indicates the condition of all masked bits in the auxiliary 1 status word. Likewise, bit 30 of the receiver status word corresponds to the auxiliary 2 status word and bit 29 to the auxiliary 3 status word.

Refer also to the **RXSTATUS** log in the [OEM7 Commands and Logs Reference Manual](#) for a more detailed description.

#### 4.3.6 Set and Clear Mask for all Status Code Arrays

The other two mask words in the status code arrays operate on the associated status word in the same way. These mask words are used to configure the bits in the status word that result in a **RXSTATUSEVENT** log broadcast. The set mask is used to turn logging on temporarily while the bit changes from the 0 to 1 state. The clear mask is used to turn logging on temporarily while the bit changes from a 1 to a 0 state. Note the error word does not have any associated mask words. Any bit set in the error word results in a **RXSTATUSEVENT** log broadcast (unless unlogged).

Refer also to the **RXSTATUS** log in the [OEM7 Commands and Logs Reference Manual](#) for a more detailed description.



# Chapter 5 Ethernet Configuration

This chapter describes how to configure the Ethernet port on an OEM7 receiver. It provides the step-by-step process for connecting to the OEM7 receiver through the Ethernet interface, setting up a base/rover configuration through Ethernet connectivity and utilizing the NTRIP interface. The Ethernet port connections for a computer connected to the receiver are also described for Windows 7 operating systems.



In this chapter, references to OEM7 receivers includes the PwrPak7.



The **SAVEETHERNETDATA** command can be issued to retain the Ethernet configuration settings after a RESET/FRESET command. The **ETHCONFIG** command and **IPCONFIG** command must be issued prior to using **SAVEETHERNETDATA** command. Refer to the [OEM7 Commands and Logs Reference Manual](#).

## 5.1 Required Hardware

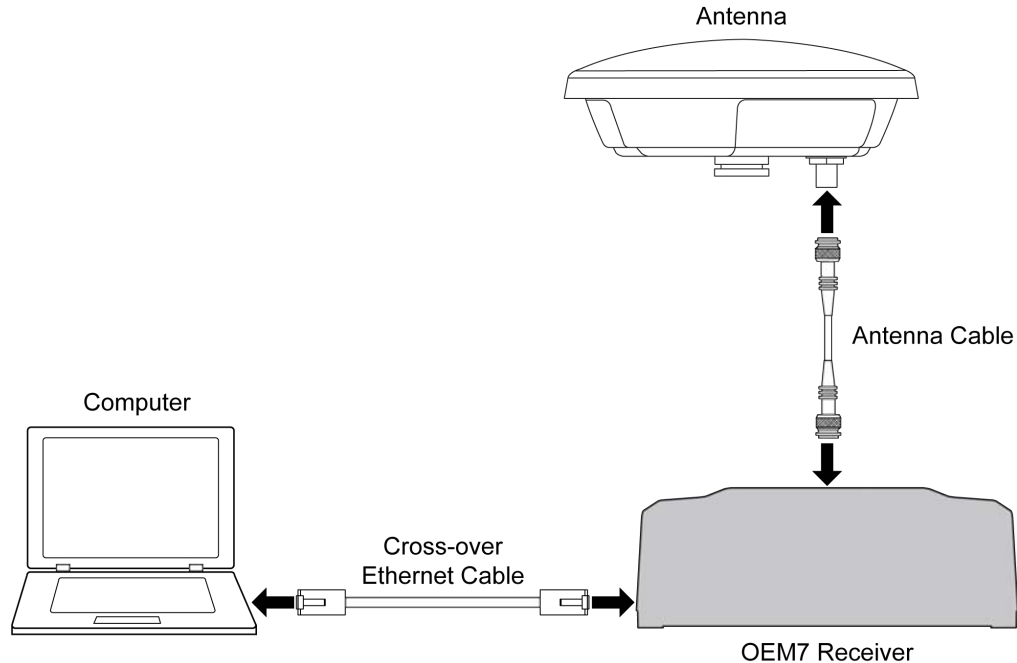
The following hardware is required to set up an Ethernet interface to an OEM7 receiver:

- a user supplied computer with an available Ethernet, serial or USB port
- a GNSS antenna
- an Ethernet capable OEM7 receiver
- an RS-232 null modem cable or USB cable
- one or two CAT5 Ethernet cables
- a user supplied Ethernet network, hub or wired router (optional)
- a coaxial antenna cable (50  $\Omega$ )

## 5.2 Static IP Address Configuration

For a static IP address configuration, unique IP addresses are assigned to both the OEM7 receiver and the computer. TCP/IP is used for the connection in this simple network. This configuration can also be used in a bench test environment to confirm Ethernet functionality.

For connections when an OEM7 receiver uses a static IP address configuration, refer to *Figure 28: Cross-Over Ethernet Cable Configuration—OEM7 Receiver* on the next page.

**Figure 28: Cross-Over Ethernet Cable Configuration—OEM7 Receiver**

### 5.2.1 Static IP Address Configuration—Receiver

Follow these steps to set up a static IP address on the OEM7 receiver:

1. Connect a computer to the OEM7 receiver using a null modem serial cable or USB cable.
2. Establish a connection to the receiver using either NovAtel Connect or another terminal program. This connection is used to send the commands in this procedure to the receiver.



For information about establishing a connection using NovAtel Connect, refer to the Help within NovAtel Connect.



NovAtel Connect version 2.0 or greater is required for OEM7 receivers. Download the latest NovAtel Connect software and documentation from [www.novatel.com/novatel-connect](http://www.novatel.com/novatel-connect).

3. Enable the Ethernet port on the receiver by entering:

```
ETHCONFIG ETHA AUTO AUTO AUTO AUTO
```

4. Assign the TCP/IP port number used for the connection by entering:

```
ICOMCONFIG ICOM1 TCP :2000
```

5. Assign the receiver IP address, subnet mask and default gateway by entering:

```
IPCONFIG ETHA STATIC 192.168.74.10 255.255.255.0 192.168.74.1
```



The command assigns the following values to the OEM7 receiver:

```
IP address = 192.168.74.10  
Subnet mask = 255.255.255.0  
Gateway = 192.168.74.1
```

These settings are examples only. The settings appropriate to your system may be different.

6. Save the new Ethernet settings by entering:

```
SAVEETHERNETDATA
```

7. Log the **IPCONFIG** command and confirm the TCP/IP configuration by entering:

```
LOG IPCONFIG ONCE
```

8. Configure your computer with a static IP address.  
Refer to *Static IP Address Configuration—Windows 7* below.

### 5.2.2 Static IP Address Configuration—Windows 7

Follow these steps to set up a static IP address on a computer:

1. Click **Start | Control Panel**.
2. Click **Network and Sharing Center**.
3. Click the **Local Area Connection** link.  
The Local Area Connection Status window appears.
4. Click the **Properties** button.  
The Local Area Connection Properties window appears.
5. Select **Internet Protocol Version 4 (TCP/IPv4)** and then click the **Properties** button.  
The Internet Protocol Version 4 (TCP/IPv4) Properties window appears.
6. Click the **Use the Following IP Address** radio button, then enter the IP address, Subnet mask and Default gateway for the Ethernet port on the computer.



Ensure the Ethernet settings used for the computer are compatible with the Ethernet settings on the OEM7 receiver.

For example, the following settings are compatible with the OEM7 receiver settings used in *Static IP Address Configuration—Receiver* on the previous page:

```
IP address = 192.168.74.11  
Subnet mask = 255.255.255.0  
Gateway = 192.168.74.1
```

7. Click the **OK** button.  
The Local Area Connection Properties window appears.
8. Click the **Close** button.  
The Local Area Connection Status window appears.
9. Click the **Close** button.
10. Proceed to *Confirming Ethernet Setup* on the next page.

### 5.2.3 Confirming Ethernet Setup

1. Connect the computer to the OEM7 receiver using an Ethernet cross-over cable. See *Figure 28: Cross-Over Ethernet Cable Configuration—OEM7 Receiver* on page 90.
2. Connect to the receiver using NovAtel Connect or any third party terminal program that supports TCP/IP connections. Use the static IP address and port number assigned to the OEM7 receiver in *Static IP Address Configuration—Receiver* on page 90.

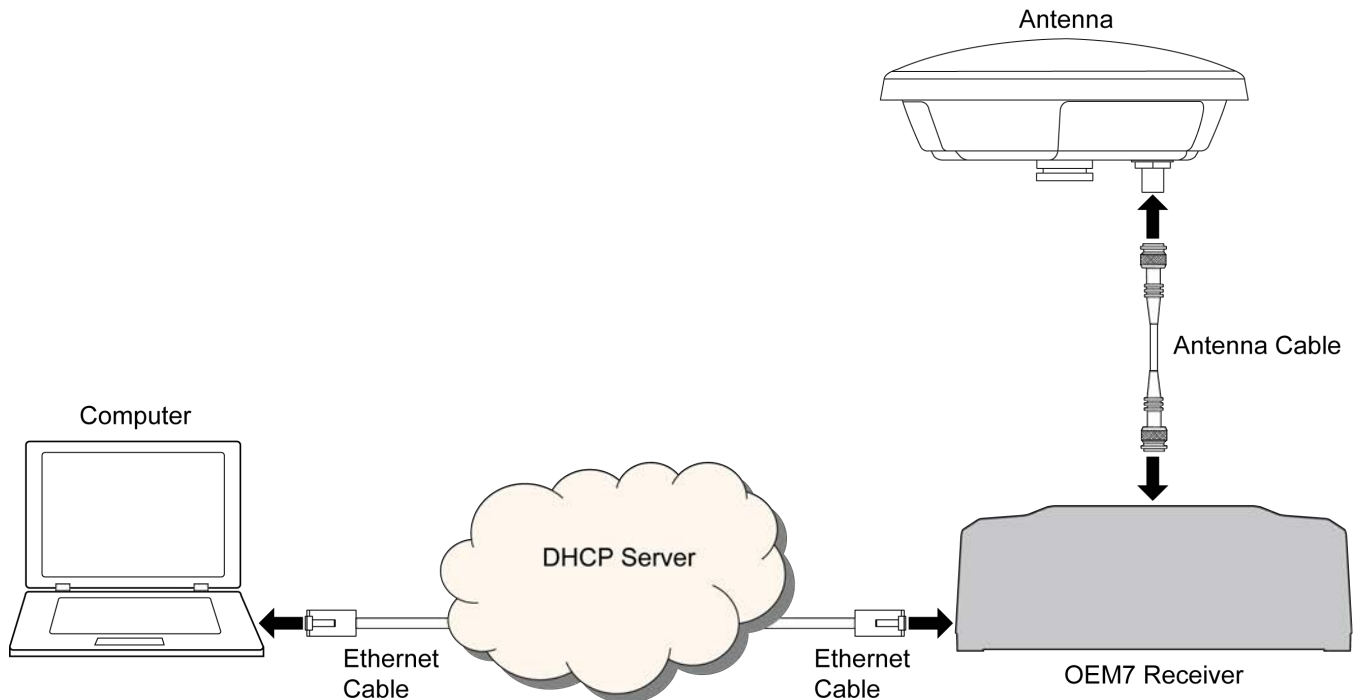


NovAtel Connect version 2.0 or greater is required for OEM7 receivers. Download the latest NovAtel Connect software and documentation from [www.novatel.com/novatel-connect](http://www.novatel.com/novatel-connect).

## 5.3 Dynamic IP Address Configuration

*Figure 29: Dynamic IP Address Configuration through a DHCP Server—OEM7 Receiver* below shows the connections when an OEM7 receiver uses a dynamic IP address configuration.

**Figure 29: Dynamic IP Address Configuration through a DHCP Server—OEM7 Receiver**



To set up a dynamic IP address configuration, follow these steps:

1. Connect a computer to the OEM7 receiver using a null modem serial cable or USB cable (model dependent).
2. Establish a connection to the receiver using either NovAtel Connect or another terminal program. This connection is used to send the commands in this procedure to the receiver.



For information about establishing a connection using NovAtel Connect, refer to the Help within NovAtel Connect.



NovAtel Connect version 2.0 or greater is required for OEM7 receivers. Download the latest NovAtel Connect software and documentation from [www.novatel.com/novatel-connect](http://www.novatel.com/novatel-connect).

3. Enable the Ethernet port by entering:

```
ETHCONFIG ETHA AUTO AUTO AUTO AUTO
```

4. Obtain the IP address assigned to the OEM7 receiver by the DHCP server.

```
LOG IPSTATUS ONCE
```



Make a note of the IP address returned with this log.

5. Assign the TCP/IP port number by entering:

```
ICOMCONFIG ICOM1 TCP :2000
```

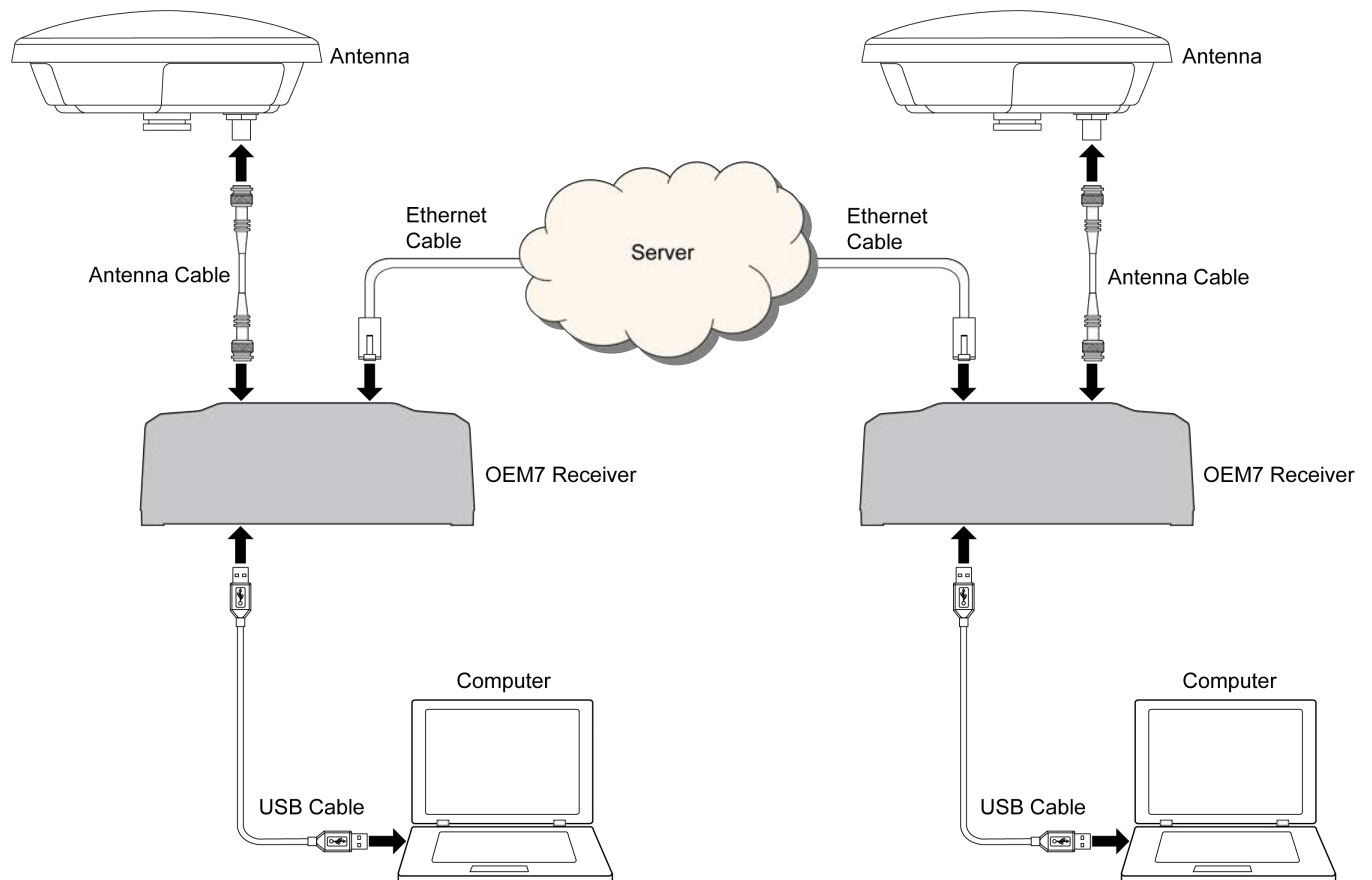
6. Confirm the port number assigned to ICOM1 by entering:

```
LOG ICOMCONFIG ONCE
```

## 5.4 Base/Rover Configuration through Ethernet Connectivity

You can use an Ethernet connection to provide communication between a base and rover receiver.

*Figure 30: Base/Rover Ethernet Setup—OEM7 Receiver* on the next page shows the connections when a base and rover OEM7 receiver are connected using Ethernet.

**Figure 30: Base/Rover Ethernet Setup—OEM7 Receiver**

1. Connect your computer to both OEM7 receivers using null modem serial cables or USB cables.
2. Establish a connection to the receiver using either NovAtel Connect or another terminal program. This connection is used to send the commands in this procedure to the receivers.



For information about establishing a connection using NovAtel Connect, refer to the Help within NovAtel Connect.



NovAtel Connect version 2.0 or greater is required for OEM7 receivers. Download the latest NovAtel Connect software and documentation from [www.novatel.com/novatel-connect](http://www.novatel.com/novatel-connect).

3. Connect the power cables to both of the OEM7 receivers and apply power to the receivers.
4. Connect the Ethernet cables to the Ethernet ports on both OEM7 receivers.
5. Establish an Ethernet connection, either static or dynamic configurations. Refer to *Static IP Address Configuration* on page 89 or *Dynamic IP Address Configuration* on page 92 for more information.
6. Send the following commands to each receiver either through serial or USB ports:

**Base:**

```
FIX POSITION <lat> <long> <height>
INTERFACEMODE ICOM1 NONE RTCA off
LOG ICOM1 RTCAOBS2 ONTIME 1
LOG ICOM1 RTCAREF ONTIME 10
LOG ICOM1 RTCA1 ONTIME 5
SAVECONFIG
```

**Rover:**

```
ICOMCONFIG ICOM1 TCP <base ip address>:<base port #>
INTERFACEMODE ICOM1 RTCA NONE OFF
LOG BESTPOSA ONTIME 1 (optional)
SAVECONFIG
```

Use the **BESTPOS** log to confirm that the OEM7 rover is in RTK mode.

## 5.5 Large Ethernet Port Data Throughput

For high data rate Ethernet logging using TCP/IP, disable Windows Delayed Ack Algorithm (DAA) for complete data logging. If you do not disable DAA, there will be data gaps due to the Windows Ethernet buffer.

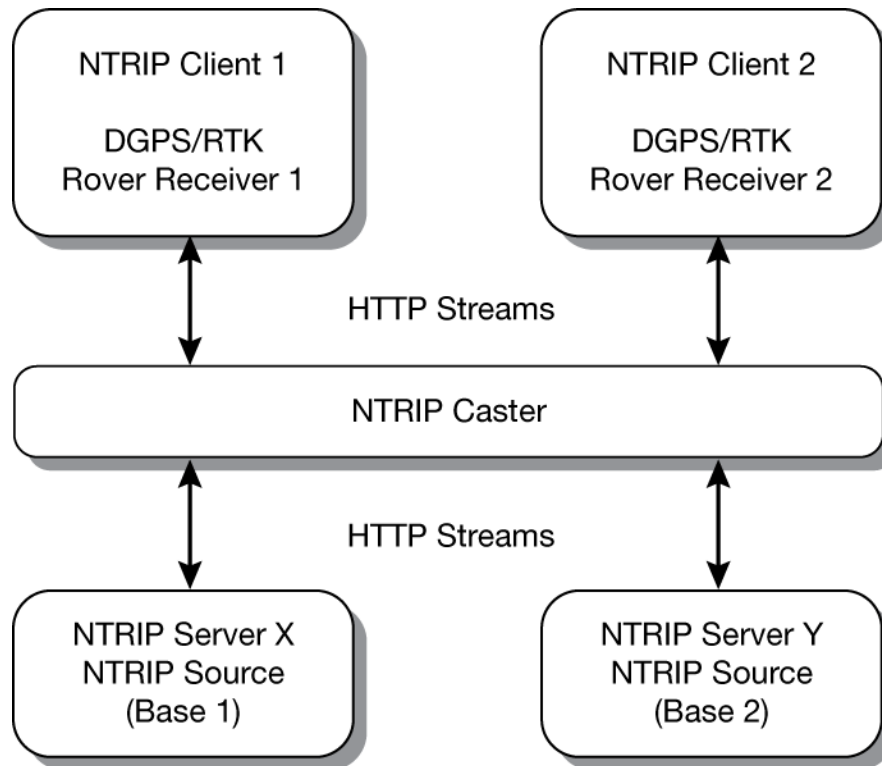


If done incorrectly, changing the Windows Registry may impair the operation of the computer. Editing the Windows Registry is for advanced Microsoft Windows users only. NovAtel Inc. is not able to provide any technical support for any actions taken regarding information found in Microsoft's Knowledge Base.

## Chapter 6 NTRIP Configuration

An Ethernet capable OEM7 receiver can be configured as either an NTRIP server or an NTRIP client. An OEM7 receiver using a Wi-Fi connection can be configured as an NTRIP client. For more information about NovAtel's NTRIP, refer to [www.novatel.com/products/firmware-options/ntrip/](http://www.novatel.com/products/firmware-options/ntrip/).

**Figure 31: NTRIP System**



The NTRIP caster is an HTTP internet service that acts as a communication medium between NTRIP servers and NTRIP clients. The NTRIP caster is provided by third party sources. For a full list of NTRIP casters, refer to the following link: <http://www.rtcn-ntrip.org/home>.

### 6.1 NTRIP Configuration Over Ethernet

The following procedure describes how to configure a NovAtel base and a NovAtel rover through a third party NTRIP caster. This configuration is recommended for optimal RTK performance.

1. Establish a connection to the receiver using either NovAtel Connect or another terminal program. This connection is used to send the commands in this procedure to the receiver.



For information about establishing a connection using NovAtel Connect, refer to the Help within NovAtel Connect.





NovAtel Connect version 2.0 or greater is required for OEM7 receivers. Download the latest NovAtel Connect software and documentation from [www.novatel.com/novatel-connect](http://www.novatel.com/novatel-connect).

2. Connect the Ethernet cable to the Ethernet ports on both OEM7 receivers. For this setup, use a cross-over Ethernet cable.
3. Establish a static or dynamic Ethernet connection.  
For information about creating the connection, refer to *Static IP Address Configuration* on page 89 or *Dynamic IP Address Configuration* on page 92.
4. Use the following commands to enable the base receiver as an NTRIP Server:

```
NTRIPCONFIG NCOM1 SERVER V2 <endpoint> <mountpoint> <username>
<password> ETHA
INTERFACEMODE NCOM1 NONE RTCA OFF
FIX POSITION <lat> <long> <height>
LOG NCOM1 RTCAOBS2 ONTIME 1
LOG NCOM1 RTCAREF ONTIME 10
LOG NCOM1 RTCA1 ONTIME 1
SAVECONFIG
```

5. Use the following commands to enable the rover receiver as an NTRIP Client:

```
ETHCONFIG ETHA AUTO AUTO AUTO AUTO
NTRIPCONFIG NCOM1 CLIENT V1 <endpoint> <mountpoint> <username>
<password > ETHA
```



If using a specific Network RTK system, certain National Marine Electronics Association (NMEA) strings are required to be sent from the rover back to the RTK network. For example, if connected to the VRS mount point, the rover is required to send its position to the network in a standard NMEA GGA message. This is achieved by issuing the following commands: **LOG NCOMx GPGGA ONTIME 5**, until data is received by the caster. For more information about Network RTK options and properties, refer to the application note [APN-041 Network RTK](#) and [APN-074: NTRIP on NovAtel OEM6/OEM7](#).

The following is an NTRIP Client configuration example without the use of a Network RTK system:

```
INTERFACEMODE NCOM1 RTCA NONE OFF
RTKSOURCE AUTO ANY
PSRDIFFSOURCE AUTO ANY
LOG BESTPOS ONTIME 1 (optional)
SAVECONFIG
```

## 6.2 NTRIP Configuration Over Wi-Fi

The following procedure describes how to configure a NovAtel rover through a third party NTRIP caster.

1. Establish a connection to the receiver using either NovAtel Connect or another terminal program. This connection is used to send the commands in this procedure to the receiver.



For information about establishing a connection using NovAtel Connect, refer to the Help within NovAtel Connect.



NovAtel Connect version 2.0 or greater is required for OEM7 receivers. Download the latest NovAtel Connect software and documentation from [www.novatel.com/novatel-connect](http://www.novatel.com/novatel-connect).

2. Log **WIFISTATUS** to monitor the Wi-Fi status on the receiver.

```
LOG WIFISTATUS ONCHANGED
```

3. Set the Wi-Fi mode.

```
WIFIMODE CLIENT
```

4. Check for available Wi-Fi access points.

```
LOG WIFINETLIST
```

5. Establish a connection with a Wi-Fi access point.

```
WIFINETCONFIG 1 ENABLE <access point name> <password>
```

6. Enable the receiver as an NTRIP client.

```
NTRIPCONFIG NCOM1 CLIENT V2 <endpoint> <mountpoint> <username>  
<password>
```



Refer to the **NTRIPCONFIG** command in the [OEM7 Commands and Logs Reference Manual](#) for further command details.

# Chapter 7 PwrPak7 Wi-Fi Configuration

The PwrPak7 has a Wi-Fi transceiver that works as a 2.4 GHz 802.11 Access Point (AP). By default, the Wi-Fi AP is configured with the settings shown in *Table 12: Wi-Fi Default Configuration* below and is enabled when the PwrPak7 is powered on.



The term passkey and password are the same.

**Table 12: Wi-Fi Default Configuration**

Parameter	Default
Mode	AP
SSID	Printed on the PwrPak7 label
Passkey	Printed on the PwrPak7 label
Channel	11
IP address	192.168.19.1
Netmask	255.255.255.0

To view the current Wi-Fi settings, use the **WIFIAPSETTINGS** log. For information about this log and the commands in the Wi-Fi configuration procedures, refer to the [OEM7 Commands and Logs Reference Manual](#).

To change the Wi-Fi configuration, use the following procedures:

- *Enable the Wi-Fi Access Point* below
- *Disable Wi-Fi* on the next page
- *Change the Wi-Fi PassKey* on the next page
- *Change the Wi-Fi Channel* on the next page
- *Change the Wi-Fi IP Address* on page 101

## 7.1 Enable the Wi-Fi Access Point

1. Start a command line interface (CLI) session with the receiver.  
Use a USB, Ethernet or Serial (COM) port connection.
2. Use the **WIFIMODE** command to enable the Wi-Fi transceiver as an AP.  

```
WIFIMODE AP
```
3. Use the **SAVECONFIG** command to store the change in Non-Volatile Memory.  
This ensures the changes are kept when the receiver is restarted.

## 7.2 Disable Wi-Fi

1. Start a CLI session with the receiver.  
Use a USB, Ethernet or Serial (COM) port connection.
2. Use the **WIFIMODE** command to disable the Wi-Fi transceiver.  

```
WIFIMODE OFF
```
3. Use the **SAVECONFIG** command to store the change in Non-Volatile Memory.  
This ensures the changes are kept when the receiver is restarted.

## 7.3 Change the Wi-Fi PassKey

1. Start a CLI session with the receiver.  
Use a USB, Ethernet or Serial (COM) port connection.
2. Use the **WIFIAPPASSKEY** command to change the Wi-Fi passkey.

```
WIFIAPPASSKEY NewPasskey
```

The new passkey must be a null terminated ASCII string that is 8 to 64 characters long.



The passkey will not change until the Wi-Fi transceiver has been restarted.

3. Use the **WIFIMODE** command to restart the Wi-Fi transceiver.  

```
WIFIMODE AP
```
4. Use the **SAVECONFIG** command to store the change in Non-Volatile Memory.  
This ensures the new passkey is kept when the receiver is restarted.

## 7.4 Change the Wi-Fi Channel

1. Start a CLI session with the receiver.  
Use a USB, Ethernet or Serial (COM) port connection.
2. Use the **WIFIAPCHANNEL** command to change the Wi-Fi channel.

```
WIFIAPCHANNEL 3
```

The channel must be a number from 1 to 14.



The Wi-Fi channel will not change until the Wi-Fi transceiver has been restarted.

3. Use the **WIFIMODE** command to restart the Wi-Fi transceiver.  

```
WIFIMODE AP
```
4. Use the **SAVECONFIG** command to store the change in Non-Volatile Memory.  
This ensures the new channel is kept when the receiver is restarted.

## 7.5 Change the Wi-Fi IP Address

1. Start a CLI session with the receiver.  
Use a USB, Ethernet or Serial (COM) port connection.
2. Use the **WIFIPIPCONFIG** command to change the Wi-Fi IP address and netmask.

```
WIFIPIPCONFIG xxx.xxx.xxx.xxx yyy.yyy.yyy.yyy
```

In the command above xxx.xxx.xxx.xxx represents the IP address and yyy.yyy.yyy.yyy represents the netmask. For example:

```
WIFIPIPCONFIG 192.162.55.20 255.255.0.0.
```



The Wi-Fi IP address and netmask will not change until the Wi-Fi transceiver has been restarted.

3. Use the **WIFIMODE** command to restart the Wi-Fi transceiver.  

```
WIFIMODE AP
```
4. Use the **SAVECONFIG** command to store the change in Non-Volatile Memory.  
This ensures the new IP address and netmask are kept when the receiver is restarted.

## Chapter 8 CAN Bus

The OEM7 receivers support the following CAN protocols:

- J1939 Transport and Extended Transport Protocol: used for corrections and NovAtel messages (both transmitting and receiving)
- NMEA2000: used for standard as well as NovAtel-proprietary messages (transmitting only)

By default, CAN is disabled on OEM7 receivers. Critical CAN configuration parameters such as Parameter Group Numbers (PGNs), addresses and priorities are system-specific and must be explicitly configured.

The addresses and PGNs are typically allocated when the overall CAN bus topology is determined. A Node has a unique CAN J1939 NAME and address.



The PwrPak7 has internal CAN transceivers, however it still requires proper bus terminations.

The SMART2 has internal CAN transceivers, however they still require proper bus terminations.

Refer to *PwrPak7 Connectors* on page 146 for pin-out information.

OEM7 receivers support the following NMEA2000 Parameter Group Messages (PGN) over the CAN bus:

- PGN 126992 System Time
- PGN 129025 GNSS Position Rapid Update
- PGN 129026 COG & SOG Rapid Update
- PGN 129027 Position Delta High Precision Rapid Update
- PGN 129029 GNSS Position
- PGN 129551 GNSS Differential Signal

The following commands and logs are used for CAN configuration:

- **CANCONFIG** command: controls the CAN transceiver hardware and places the receiver *on bus* or *off bus*
- **J1939CONFIG** command: assigns the CAN J1939 NAME and address parameters to a Node
- **J1939STATUS** log: reports the status a Node on the J1939 CAN network, such as the claimed address
- **LOG CCOMx PGNabcd**: configures the NMEA2000 messages
- **CCOMCONFIG** command: configures the parameters used by the NovAtel command interface to interact with the CAN Bus



CCOM ports with a lower port number have a higher transmission priority.



For information about these commands, see the [OEM7 Commands and Logs Reference Manual](#).



Details for the PGN messages can be found in the NMEA2000 specification which can be purchased directly from the National Marine Electronics Association ([www.nmea.org/](http://www.nmea.org/)).

## 8.1 Default Configuration

After a FRESET, the receiver has the following CAN configuration:

- All CAN physical ports are disabled
- No J1939 addresses are configured
- CCOM ports are configured for NMEA2000 messages only

**Table 13: Default NAME**

Parameter	Value
Address	0xFE
Industry Group	2
Device Class	0
Device Class Instance	0
Function	23
Function Instance	0
ECU Instance	0
Manufacturer Code	0
Identity Number	0

## 8.2 Configuring the CAN Bus

To enable an OEM7 receiver to communicate over the CAN bus, configure CAN and place the receiver *on bus*, triggering a J1939 *Address Claim Procedure*.

1. Use the **J1939CONFIG** command to specify J1939 NAME and desired address.
2. Use the **CANCONFIG** command to place the receiver *on bus*.
3. Optionally, use the **J1939STATUS** log to monitor CAN status on the receiver.

### 8.2.1 Configuration Notes

- The **J1939CONFIG** and **CANCONFIG** commands can be entered in any order. After the **CANCONFIG** command is used to place the receiver on the CAN bus, **J1939CONFIG**

commands take effect immediately whether entered before or after CANCONFIG. Until then, J1939CONFIG can be entered many times to change the settings because they have not taken affect yet (the receiver is not yet on the bus).

- The J1939 Address claim procedure is executed if and only if both J1939CONFIG NODEx CANx and CANCONFIG CANx ON are entered.
- Use J1939STATUS log to determine the receiver's CAN status and the actual address claimed by a particular node.
- Once the receiver is "on bus", it must be taken "off-bus" using CANCONFIG for any further configuration changes using J1939CONFIG.
- The receiver is fully "on-bus" only once the J1939 address has been successfully claimed. This is reported as "CLAIMED" status by J1939STATUS log.
- No messages will be sent or received until the receiver is "online" and an address is claimed. Outgoing messages are not buffered; they are discarded until the receiver is online.

### **8.2.2 Example of Enabling the CAN Bus**

1. LOG J1939STATUS ONCHANGED
2. J1939CONFIG NODE1 CAN1 <addresses>
3. CANCONFIG CAN1 ON 250K
4. SAVECONFIG
  - < J1939STATUS NODE1 DISABLED 0 0xFE
  - < J1939STATUS NODE1 CLAIMING 1 <address>
  - < J1939STATUS NODE1 CLAIMED <attempt count> <address>

### **8.2.3 Example of Modifying the CAN Bus Parameters**

1. LOG J1939STATUS ONCHANGED
2. CANCONFIG CAN1 OFF
3. J1939CONFIG NODE1 CAN1 <addresses>
4. CANCONFIG CAN1 ON
5. SAVECONFIG
  - < J1939STATUS NODE1 DISABLED 0 0xFE
  - < J1939STATUS NODE1 CLAIMING 1 <address>
  - < J1939STATUS NODE1 CLAIMED <attempt count> <address>

### **8.2.4 Example of Detecting an Address Claim Failure and Reconfiguring**

1. LOG J1939STATUS ONCHANGED
2. J1939CONFIG NODE1 CAN1 <addresses>
3. CANCONFIG CAN1 ON
  - < J1939STATUS NODE1 DISABLED 0 0xFE
  - < J1939STATUS NODE1 CLAIMING 1 <address>



```
< J1939STATUS NODE1 FAILED <attempt count> 0xFE
```

4. **CANCONFIG CAN1 OFF**

```
< J1939STATUS NODE1 DISABLED 0 0xFE
```

5. **J1939CONFIG NODE1 CAN1 <addresses>**

6. **CANCONFIG CAN1 ON**

```
< J1939STATUS NODE1 CLAIMING 1 <address>
```

```
< J1939STATUS NODE1 CLAIMED <attempt count> <address>
```

### 8.2.5 Address Claim Procedure

To become operational on the CAN bus, an OEM7 receiver must claim a J1939 address. The preferred address and a range of alternative addresses are specified using the **J1939CONFIG** command. When a configured receiver is placed *on bus*, it may make multiple attempts to claim an address. It may also have its address bumped by a higher priority device claiming the same address.

While the device is attempting to claim an address, the **J1939STATUS** log reports a status of *CLAIMING* and automatically tries to claim the next allowed address. Depending on the **J1939CONFIG** parameters, an address different from the **J1939CONFIG** *preferred address* may be claimed or the address claim procedure can fail entirely. If no addresses could be claimed, a *FAILED* status is reported and the receiver takes no further action. To recover from this failure, take the receiver *off bus* using the **CANCONFIG** command and change the CAN address configuration using the **J1939CONFIG** command.

The address can also be assigned using J1939 *Commanded Address* message sent by another ECU on the bus, such as a tester unit. The commanded address always overrides the address specified using **J1939CONFIG** command. When the *Commanded Address* is received, the receiver reports a status of *CLAIMING* followed by *CLAIMED*. Restarting CAN using the **J1939CONFIG** command or **CANCONFIG** command clears the commanded address; the Address Claim procedure will be executed again based on parameters specified in the **J1939CONFIG** command.

## 8.3 NMEA2000 Logging

OEM7 receivers support both a subset of the standard NMEA2000 PGNs, as well as NovAtel proprietary PGNs.

All NMEA2000 logs are configured using the **LOG** command, where the COM port is a CAN port (CCOM). The CCOM port must be associated with a J1939 node using the **CCOMCONFIG** command. If only NMEA2000 logs are needed, **CCOMCONFIG** parameters other than J1939NODE may be ignored.

To enable NMEA2000 logs:

1. Configure the CAN bus. See *Configuring the CAN Bus* on page 103.
2. Enable the CCOM port on the CAN bus node using the **CCOMCONFIG** command.
3. Enable the desired NMEA2000 logs.

NMEA2000 logs can be requested regardless of the on/off bus status of the receiver or the J1939 configuration. They are output if and only if the receiver is online.

### 8.3.1 Example of NMEA2000 Log Configuration

1. CCOMCONFIG CCOM1 NODE1 NMEA2000
2. LOG CCOM1 PGN129025 ONTIME 0.5
3. LOG CCOM1 PGN129026 ONTIME 0.25
4. SAVECONFIG

## 8.4 Corrections Over CAN

All NovAtel supported correction types are supported over CAN ports (CCOM).

To send or receive corrections:

1. Configure the CAN Bus. See *Configuring the CAN Bus* on page 103.
2. Use the **CCOMCONFIG** command to configure the PGN and other CAN parameters used by the RTK corrections CAN messages.

**PGN:** Use the PGN designated for corrections.

**Address:**

- Use 0xFF to receive corrections from any CAN address and to broadcast corrections to all CAN nodes.
  - Use 0x00 to 0xFE to send corrections to or receive corrections from a specific CAN node.
3. Use the **INTERFACEMODE** command to configure the CCOM interface mode.
    - To transmit corrections, use the desired INTERFACEMODE, e.g. RTCMV3
    - To receive corrections, it is recommended to use INTERFACEMODE AUTO.



Corrections configuration (**CANCONFIG** and **INTERFACEMODE**) for a particular CCOM port do not affect its NMEA2000 configuration. NMEA2000 logs coexist with correction messages, both incoming and outgoing.

### 8.4.1 Example for Receiving Corrections from Any Source

1. CCOMCONFIG CCOM2 NODE1 J1939 61184 6 0xFF
2. INTERFACEMODE CCOM2 AUTO NONE OFF

### 8.4.2 Example for Transmitting Corrections to 0x1C Node

1. CCOMCONFIG CCOM2 NODE1 J1939 61184 6 0x1c
2. INTERFACEMODE CCOM2 NONE RTCMV3 OFF

## 8.5 NovAtel Messages Over CAN

Standard NovAtel messages (commands, logs, responses) can be sent and received on the CAN Bus using CAN ports (CCOM). To reduce CAN Bus loading, NovAtel messages are sent using NovAtel standard binary format over J1939 (default).

The CCOM port requires special configuration and has the following limitations:

- A single CCOM port cannot be used for both Binary and ASCII / NovAtel ASCII messages.
- A single CCOM port cannot be used for both Binary messages and corrections.
- If the CCOM port is configured as *NOVATEL*, all input is interpreted as NovAtel ASCII or Abbreviated ASCII. Unlike other COM ports, the receiver will not distinguish between ASCII and binary input.
- To use CAN NOVATELBINARY, the CCOM port must be placed into NOVATELBINARY using the **INTERFACEMODE** command.



It is recommended to use one dedicated CCOM port for NovAtel messages and another dedicated CCOM port for corrections.



NovAtel UI configuration does not affect NMEA2000. Any CCOM port can be used for NMEA2000 logs irrespective of CCOMCONFIG settings.

To configure NovAtel User Interface over CAN:

1. Configure the CAN Bus. See *Configuring the CAN Bus* on page 103.
2. Use the **CCOMCONFIG** command to configure the PGN and other CAN parameters.
3. Use the **INTERFACEMODE** command to configure the CCOM port for **NOVATELBINARY**.

Example: Configuring CCOM2 for NovAtel messages:

1. `CCOMCONFIG CCOM2 NODE1 1234 6 0x1C`
2. `INTERFACEMODE CCOM2 NOVATELBINARY NOVATELBINARY OFF`

## 8.6 Configuring OEM7 Receivers to Use OEM6 CAN Settings

CAN Bus functionality has been enhanced on OEM7 receivers. To accommodate the enhancements in functionality and flexibility, several new commands and logs have been added. Also, the **SETCANNNAME** command has been removed and the **CANCONFIG** command has been modified.

The following sections describes how to configure CAN on OEM7 receivers to operate like OEM6 receivers.

### 8.6.1 Configuration on OEM6

On OEM6 receivers, the **SETCANNNAME** command, with minimal parameters, could be used to configure CAN.

```
SETCANNNAME 305
```

Once entered, a limited address claim procedure would take place and NMEA2000 logs would be generated automatically at a fixed logging rate and fixed CAN port bit rate.

### 8.6.2 Configuration on OEM7

To configure an OEM7 receiver to log the same commands and use the same logging rate and CAN port bit rate, enter the following commands:

```
CCOMCONFIG CCOM1 NODE1 NMEA2000
CANCONFIG CAN1 ON 250K
LOG CCOM1 PGN129025 ONTIME 0.1
LOG CCOM1 PGN129026 ONTIME 0.1
LOG CCOM1 PGN129029 ONTIME 1.0
SAVECONFIG
```

On OEM7 receivers, nothing is automatically logged when CAN is enabled. Regular log requests must be made for each log required.

A full address claim procedure with default values is initiated with the **CANCONFIG ON** command. The J1939CONFIG command can be used to modify the default address claim parameters including the ManufacturingCode (set to 603 in the SETCANNNAME example above, now defaults to 305 in the new J1939CONFIG) but it's not necessary.

## Chapter 9 Troubleshooting

There are simple ways to diagnose and resolve problems. In many cases, the issue can be resolved within a few minutes, avoiding the inconvenience and loss of productivity that results from having to return the receiver for repair. This section discusses troubleshooting issues and includes cross-references to other sections of the manual that may help resolve problems.

If unsure of the symptoms or if the symptoms do not match any of those listed, use the RXSTATUS log to check the receiver status and error words. See *Examining the RXSTATUS Log* on the next page.

Try to resolve the problem using the troubleshooting guide in *Table 14: Troubleshooting Based on Symptoms* below, then try our Knowledge Base at [www.novatel.com/support/](http://www.novatel.com/support/). If you are still not able to resolve the problem, see *Customer Support* on page 20 for troubleshooting logs and contact information.

**Table 14: Troubleshooting Based on Symptoms**

Symptom	Related Section
The receiver is not properly powered	Check the power cable. Replace if faulty. See: <ul style="list-style-type: none"> <li>• <i>Power Supply Requirements for the PwrPak7</i> on page 32</li> </ul>
The receiver cannot establish communication	Check the serial cables and ports. Replace if faulty See <i>CAN Bus</i> on page 102. Refer also to the <b>SERIALCONFIG</b> command in the <a href="#">OEM7 Commands and Logs Reference Manual</a>
The receiver is not tracking satellites	Ensure that the antenna has an unobstructed view of the sky from horizon to horizon.  Check the RXSTATUS error states. See <i>Examining the RXSTATUS Log</i> on the next page. If the receiver is in error mode, it does not track.  Use the Interference Toolkit to check if there is an interference signal present. See <i>Interference Toolkit</i> on page 70.  Check the antenna cable. Replace if faulty. See <i>Selecting a GNSS Antenna</i> on page 31 and <i>Choosing a Coaxial Cable</i> on page 31.
No data is being logged	See <i>CAN Bus</i> on page 102 and <i>Communications with the Receiver</i> on page 46
Random data is being output by the receiver or binary data is streaming	Check the baud rate on the receiver and in the communication software. Refer to the <b>SERIALCONFIG</b> command and <b>FRESET</b> command in the <a href="#">OEM7 Commands and Logs Reference Manual</a> . See also <i>CAN Bus</i> on page 102


Symptom	Related Section
A command is not accepted by the receiver	Check for correct spelling and command syntax. See <i>Communications with the Receiver</i> on page 46 and refer to the <b>FRESET</b> command in the <a href="#">OEM7 Commands and Logs Reference Manual</a>
Differential mode is not working properly	See <i>Transmitting and Receiving Corrections</i> on page 52 and refer to the <b>SERIALCONFIG</b> command in the <a href="#">OEM7 Commands and Logs Reference Manual</a>
There appears to be a problem with the receiver's memory	Refer to the <b>NVMRESTORE</b> command in the <a href="#">OEM7 Commands and Logs Reference Manual</a>
An environmental or memory failure. The receiver temperature is out of acceptable range or the internal thermometer is not working	Move the receiver to within an acceptable temperature range. See: <ul style="list-style-type: none"> <li>• <i>High Temperature Environments</i> on page 114</li> <li>• <i>PwrPak7 Electrical and Environmental Specifications</i> on page 141</li> </ul>
Overload and overrun problems. Either the CPU or port buffers are overloaded	Reduce the amount of logging or increase the baud rate.
The receiver is indicating that an invalid authorization code has been used	Refer to the <b>VERSION</b> log or <b>VALIDMODELS</b> log and the <b>MODEL</b> command or <b>AUTH</b> command in the <a href="#">OEM7 Commands and Logs Reference Manual</a>
The receiver is being affected by jamming	Move the receiver away from any possible jamming sources
The receiver is being affected by interference	See <i>Interference Toolkit</i> on page 70. Move the GNSS antenna away from the source of the interference signal. If the interference mitigation feature is enabled on the receiver, configure a filter within the Interference Toolkit to filter out the interference signal.
The receiver's Automatic Gain Control (AGC) is not working properly	See the jamming symptom in this table

## 9.1 Examining the RXSTATUS Log

The RXSTATUS log provides detailed status information about your receiver and can be used to diagnose problems. Refer to the **RXSTATUS** log in the [OEM7 Commands and Logs Reference Manual](#) for details on this log and on how to read the receiver error word and status word. *Table 15: Resolving a Receiver Error Word* on the next page, *Table 16: Resolving an Error in the Receiver Status Word* on page 112 and *Table 17: Resolving an Error in the AUX1 Status Word* on

page 113 have actions to take when your receiver has an error flag in these words. If you are not able to resolve the condition, contact *Customer Support* on page 20.

**Table 15: Resolving a Receiver Error Word**

Bit Set	Action to Resolve
0-2	Issue a <b>FRESET</b> command (for bit 1, reload new firmware).
4	Contact <i>Customer Support</i> on page 20
5	Check the <b>VERSION</b> log. The VERSION log will indicate "Invalid authcode". Upgrade the auth-code as described in <i>Upgrading Using an Auth-Code</i> on page 129
6	Issue a <b>FRESET</b> command
7	See <ul style="list-style-type: none"> <li>• <i>Power Supply Requirements for the PwrPak7</i> on page 32</li> </ul>
8	Reserved
9	<p>Check the temperature ranges in:</p> <ul style="list-style-type: none"> <li>• <i>PwrPak7 Electrical and Environmental Specifications</i> on page 141</li> </ul> <div style="border: 1px solid black; padding: 10px; margin-top: 10px;">  <p>The operating temperatures are ambient air temperatures. The temperature sensors on the receiver PCB will reflect higher operating temperatures (refer to the <b>HWMONITOR</b> log). The PCB temperature sensors will trigger a receiver warning and receiver error at 100°C and 110°C respectively. The warning and error conditions are captured using the <b>RXSTATUS</b> log.</p> </div>
10	Possible hardware or environmental condition. If you cannot resolve the problem, contact <i>Customer Support</i> on page 20.
11	Possible hardware or environmental condition. If you cannot resolve the problem, contact <i>Customer Support</i> on page 20. Also, check the Auxiliary 2 Status word to determine which PLL is in error.
12-14	Reserved
15	Issue a <b>FRESET</b> command and power cycle the unit. If the bit is still present, contact <i>Customer Support</i> on page 20.
16	Monitor CPU idle time. Reduce number of logs or the rate of data logging.
17	Ensure that the Version log is consistent with the hardware.
18-19	Reserved
20	SoftLoad is in progress. See <i>Updating Using SoftLoad Commands</i> on page 124.

Bit Set	Action to Resolve
21	You may be exceeding the receiver's velocity limit. If so, reduce velocity. This error can only be cleared by resetting the receiver.
22	Reload firmware using WinLoad or the SoftLoad commands.
23-30	Reserved
31	Possible hardware failure. Contact <i>Customer Support</i> on page 20.

**Table 16: Resolving an Error in the Receiver Status Word**

Bit Set	Action to Resolve
0	Check the Error Word in the <b>RXSTATUS</b> log. See also <i>Table 15: Resolving a Receiver Error Word</i> on the previous page
1	Check the temperature ranges in <ul style="list-style-type: none"> <li>• <i>PwrPak7 Electrical and Environmental Specifications</i> on page 141</li> </ul>
2	See <ul style="list-style-type: none"> <li>• <i>Power Supply Requirements for the PwrPak7</i> on page 32</li> </ul>
3	See <i>Selecting a GNSS Antenna</i> on page 31, <i>Choosing a Coaxial Cable</i> on page 31, <i>Antenna LNA Power</i> on page 36
4	
5	
6	
7	Check the CPU idle time. Check for unnecessary logging. Check for simultaneous use of functionality.
8	See <i>Table 11: Serial Ports Supported</i> on page 49 Also, check the Auxiliary 2 Status word to determine which COM port has overrun its buffer.
9-11	Reserved
15	Check the Auxiliary 1 status word to determine which RF channels are jammed.
16-17	Reserved
18	When the receiver has tracked GNSS satellites long enough for a valid almanac to be received, this bit will be set to 0.
19	None. This bit only indicates if the receiver has calculated a position.
20	None. This bit is a status bit indicating if the receiver's position has been manually fixed and does not represent a problem. Refer also to the <b>FIX</b> command in the <a href="#">OEM7 Commands and Logs Reference Manual</a> .



Bit Set	Action to Resolve
21	None. This bit indicates if clock steering has been manually disabled. Refer also to the <b>FRESET</b> command in the <a href="#">OEM7 Commands and Logs Reference Manual</a> .
22	None. This bit only indicates if the clock model is valid. Refer also to the <b>FRESET</b> command in the <a href="#">OEM7 Commands and Logs Reference Manual</a> .
23	None. This bit indicates if the phase-lock-loop is locked when using an external oscillator. Refer also to the <b>FRESET</b> command in the <a href="#">OEM7 Commands and Logs Reference Manual</a> .
24	Check the CPU idle time. Check for unnecessary logging. Check for simultaneous use of functionality.
25-26	None. These bits identify the receiver family. For OEM7 receivers, bit 25 is set to 1 and bit 26 is set to zero.
27	Interference Toolkit HDR mode status. When this bit is set to 1, Interference Toolkit HDR mode is enabled.
28	Digital filter status. When this bit is set to 1, an Interference Toolkit digital filter is enabled.
29	None. This bit indicates if any bits in the auxiliary 3 status word are set. The auxiliary 3 word provides status information and does not contain any new information on problems. Refer also to the <b>FRESET</b> command in the <a href="#">OEM7 Commands and Logs Reference Manual</a> .
30	None. This bit indicates if any bits in the auxiliary 2 status word are set. The auxiliary 2 word provides status information and does not contain any new information on problems. Refer also to the <b>FRESET</b> command in the <a href="#">OEM7 Commands and Logs Reference Manual</a> .
31	None. This bit indicates if any bits in the auxiliary 1 status word are set. The auxiliary 1 word provides status information and does not contain any new information on problems. Refer also to the <b>FRESET</b> command in the <a href="#">OEM7 Commands and Logs Reference Manual</a> .

## 9.2 Examining the AUX1 Status Word

*Table 17: Resolving an Error in the AUX1 Status Word* below provides actions to take when your receiver has an error flag in the AUX1 status word.

**Table 17: Resolving an Error in the AUX1 Status Word**

Bit Set	Action to Resolve
0-2	Jammer detected
3	None. This bit indicates that Position Averaging is ON
4-6	Jammer detected
7	Connect the receiver via USB
8-10	Reduce the amount of logging on the USB ports

Bit Set	Action to Resolve
11	(Reserved bit)
12	None. This bit indicates a Profile set using the <b>PROFILE</b> command is activated.
13	Throttled Ethernet Reception Check for unusually high Ethernet traffic being directed to the Receiver. This does not represent an error condition on the receiver, but suggests there may be an issue in the network environment on the receiver.
14-17	AGC error on RF1 through RF4 respectively. To resolve, ensure the antenna cable is connected and signal input level is within specification. Contact NovAtel Customer Support for additional information.
18	Connect the receiver via Ethernet. See <i>Ethernet Port</i> on page 40
19-21	Reduce the amount of logging on the Ethernet ports
22-24	Reduce the amount of logging on the NTRIP ports
25-27	Reduce the amount of logging on the Virtual COM ports
28-29	AGC error on RF5 (bit 28) or RF6 (bit 29). To resolve, ensure the antenna cable is connected and signal input level is within specification. Contact NovAtel Customer Support for additional information.
30-31	(Reserved bits)

## 9.3 High Temperature Environments

The operating temperature of OEM7 receivers increases as more features (channels used, HDR mode, etc.) are enabled.

When the receiver is operating in an environment that is near its maximum ambient temperature, an increase in the ambient air temperature or enabling additional features may cause the receiver to exceed its maximum operating temperature and generate a Temperature Status error. When a Temperature Status error occurs, the receiver idles all channels, turns off the antenna and disables the RF hardware. The communication interfaces continue to function so commands can be sent and logs received.

### 9.3.1 Indicators of an Error State

The indications that the receiver is in an error state, such as a Temperature Status error, are:

- Logs that have a solution status will show `INSUFFICIENT_OBS` as the Solution Status.
- The **RXSTATUSEVENT** log is output on all communication ports. This log will indicate an error condition in the Receiver Error word of the log.
- The PWR LED is red.
- All logs output have Bit 0 set in the Receiver Status word of the log header.

To determine the cause of the error, log the **RXSTATUS** log and check the Receiver Error word. If Bit 9 is set, it is a Temperature Status error. For information about reading the Error Word, refer to *Error Word* on page 86.

### 9.3.2 Recovering from a Temperature Status Error

The receiver must be reset or power cycled to recover from a receiver error such as a Temperature Status error.

Log information is lost when the receiver is reset. Therefore, any logs required to identify and troubleshoot the error, such as the **RXSTATUS** log, should be collected before resetting the receiver.

Also, steps should be taken to reduce the cause of the receiver temperature error to prevent the error from occurring again. See *Mitigating High Receiver Temperature* below.

### 9.3.3 Mitigating High Receiver Temperature

If the receiver has a high temperature warning or error, use one or more of the following suggestions to reduce the receiver temperature.

- If possible, reduce the ambient temperature around the receiver or move the receiver to an area with a lower ambient temperature.
- Disable the receiver features that are not required for the current operation of the receiver.
- On a PwrPak7, disable Wi-Fi and stop USB data transfers.

### 9.3.4 Monitoring the Receiver Temperature

If the receiver is operating in a high ambient temperature environment, you can monitor the receiver temperature using the **RXSTATUS** and **HWMONITOR** logs.

1. Log the **RXSTATUS** log and check Bit 1 of the Receiver Status word.

```
LOG RXSTATUS onchanged
<RXSTATUS USB1 0 81.5 FINESTEERING 1990 326146.020 0a104020 2ae1 14434
< 00000000 5
< 0a104020 00000000 00030000 00030000 (Receiver Status)
< 00062000 00001008 00000000 00000000
< 00000000 00000000 80000000 00000000
< 80000000 00000000 00000000 00000000
< 00000000 00000000 00000000 00000000
```

For information about reading the Receiver Status word, refer to *Status Word* on page 86.

2. If Bit 1 is 0, the temperature is okay. Continue monitoring, but no action is required.

If Bit 1 is 1, the receiver temperature has exceeded the warning limit.

3. Log the **HWMONITOR** log and check the two temperature status fields (0x01 and 0x16).

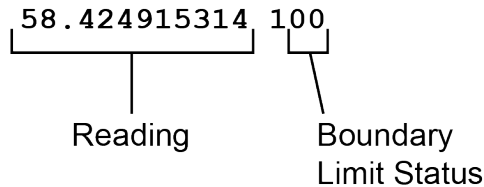
```
LOG HWMONITOR ontime 30
<HWMONITOR USB1 0 77.5 FINESTEERING 1990 326851.000 0a104020 52db 14434
< 10
< 58.424915314 100 (Temperature 0x01)
< 0.000122100 200
< 3.296703339 600
```

```

<      5.169230938 700
<      1.192307711 800
<      3.300366402 f00
<      1.833943844 1100
<      5.159462929 1500
<      1.555555582 1700
<      58.485961914 1600 (Temperature 0x16)

```

Pay attention to the reading and the boundary limit status.



Refer to Table: HWMONITOR Status Table in the **HWMONITOR** log section for a description of the Boundary Limit Status.

4. Use the suggestions in *Mitigating High Receiver Temperature* on the previous page to reduce the receiver temperature.
5. Continue monitoring the **HWMONITOR** log to see if receiver temperature is dropping.
6. Check the **RXSTATUS** log to see if the temperature status changes to Okay (Bit 1 in the Receiver Status word changes to 0).

## 9.4 Safe Mode

Safe Mode is an error condition triggered on the OEM7 receiver if it encounters certain critical problems during start-up. The receiver does not track GNSS satellites in this state, but the user interface is still available to allow for diagnosis of the problem.

The receiver will enter Safe Mode under certain rare cases including the following:

- Corrupted or bad data within the receiver Non-Volatile Memory (NVM).
- An unsupported Auth Code.
- The expected main firmware image could not be found by the boot code. This is possibly due to an error during the main firmware loading process (i.e. WinLoad, SoftLoad, etc.).

Safe Mode exists to allow users to take steps to recover the receiver after such an error occurs. Potential recovery steps are described in *Recovery Steps* on the next page.

Safe Mode is indicated by an error bit in the **RXSTATUS** log.

### 9.4.1 Reset Loop Detection

In order to determine when the Safe Mode error should be triggered, OEM7 receivers have the ability to detect when an unexpected reset has occurred during the boot process. If a Reset Loop is detected, the **Reset Loop Detected** bit is set in the **RXSTATUS** log.

This bit is only a warning and the receiver may still be able to operate correctly. The receiver will allow several unexpected resets to occur before triggering the Safe Mode Error, at which point the receiver will not track GNSS satellites.

### 9.4.2 Recovery Steps

If the **Safe Mode** error bit or the **Reset Loop Detected** warning bit are set in the **RXSTATUS** log, take the following steps to diagnose and recover the system:

1. Request the **SAFEMODESTATUS** log and determine the current *Safe Mode State* of the system.
2. Reference Table: Safe Mode States in the [OEM7 Commands and Logs Reference Manual](#) and find the suggested actions for the current Safe Mode State.
3. If the suggested actions do not resolve the issue, contact NovAtel Customer Support.

# Chapter 10 NovAtel Firmware and Software

Download the most recent versions of the NovAtel firmware and receiver software from the Downloads section of [www.novatel.com/support/search/](http://www.novatel.com/support/search/).

## NovAtel Software

NovAtel software applications run on a computer and are used to interact with NovAtel receivers. The following software is available from the NovAtel website:

- NovAtel Connect (a GUI interface)
- Convert (converts receiver data logs into different formats)
- USB Drivers

NovAtel software is available in Windows compatible and Unix compatible versions. For information about using NovAtel Connect or Convert, refer to the help system available within the application.



NovAtel Connect version 2.0 or greater is required for OEM7 receivers. Download the latest NovAtel Connect software and documentation from [www.novatel.com/novatel-connect](http://www.novatel.com/novatel-connect).

## NovAtel Firmware

NovAtel firmware runs on NovAtel receivers. It provides the features and functionality available on the receiver.

The firmware download file contains:

- Firmware \*.shex file
- WinLoad software utility

## 10.1 Firmware Updates and Model Upgrades

A local NovAtel dealer can provide all the information needed to upgrade or update a receiver. Refer to [www.novatel.com/where-to-buy](http://www.novatel.com/where-to-buy) for contact information or contact [sales@novatel.com](mailto:sales@novatel.com) or [support@novatel.com](mailto:support@novatel.com) directly.

### 10.1.1 Firmware Updates

Firmware updates are firmware releases that include fixes and enhancements to the receiver functionality. Firmware updates are released on the NovAtel web site as they become available. Firmware upgrades can be performed using the WinLoad utility, SoftLoad commands, NovAtel Web UI, NovAtel Connect or with a custom loader application. Contact NovAtel Customer Support ([support@novatel.com](mailto:support@novatel.com)) for details on custom loader requirements.

### 10.1.2 Model Upgrades

Model upgrades enable purchased receiver features.

Contact a local NovAtel dealer to assist in selecting the upgrade options that best suit your GNSS needs at [www.novatel.com/where-to-buy](http://www.novatel.com/where-to-buy). Contact NovAtel Customer Support [www.nova-](http://www.nova-)



Once the trial period has expired, a new auth-code will need to be obtained from NovAtel Customer Support ([support@novatel.com](mailto:support@novatel.com)).

Firmware images may also have auth-codes embedded within them. The models provided by such firmware images will be valid only on receivers with certain PSNs and Hardware Versions.

## 10.3 Downloading Firmware Files

To proceed with an update or possibly an upgrade, obtain the latest version of firmware by downloading the firmware file for your product from [www.novatel.com/support/firmware-downloads/](http://www.novatel.com/support/firmware-downloads/).

### 10.3.1 Format of Firmware Files

All of the firmware available on the downloads website are packaged in .zip files with the following name:

- 7XXXX-Firmware.zip for firmware to be installed on OEM7 receivers

For convenience, unzip the update file to a GNSS sub-directory (for example, C:\GNSS\LOADER). If the firmware update file is password protected, NovAtel Customer Support provides the required password.

The zip archive includes the following files:

winload.exe	WinLoad utility program
howto.txt	Instructions on how to use the WinLoad utility
whatsnew.rtf	Information on the changes made in the firmware since the last revision
x..x.shex	Firmware version upgrade file, where x..x defines the product name and release (e.g., OM7MR0200RN0000.shex)
NovAtel Software License Agreement.rtf	License agreement for the firmware



NovAtel has an online video tutorial that explains firmware updating at: [www.novatel.com/support/videos](http://www.novatel.com/support/videos).

## 10.4 Updating or Upgrading Using the WinLoad Utility

WinLoad is a utility used to update or upgrade an OEM7 receiver. To use WinLoad, the receiver must be connected to the computer running WinLoad using a serial port (COM port) connection.

### 10.4.1 Using the WinLoad Utility

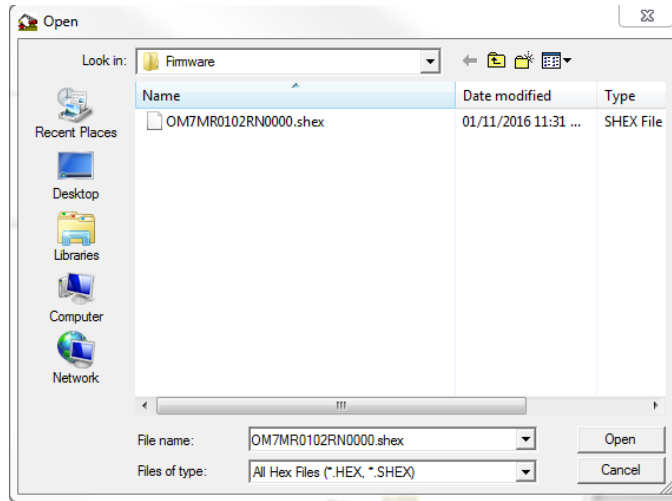
If opening WinLoad for the first time, ensure the file and communications settings are correct.

#### Open a File to Download

Select File | File Open. Navigate to the file to open (*Figure 32: WinLoad's Open Window* on the next page).

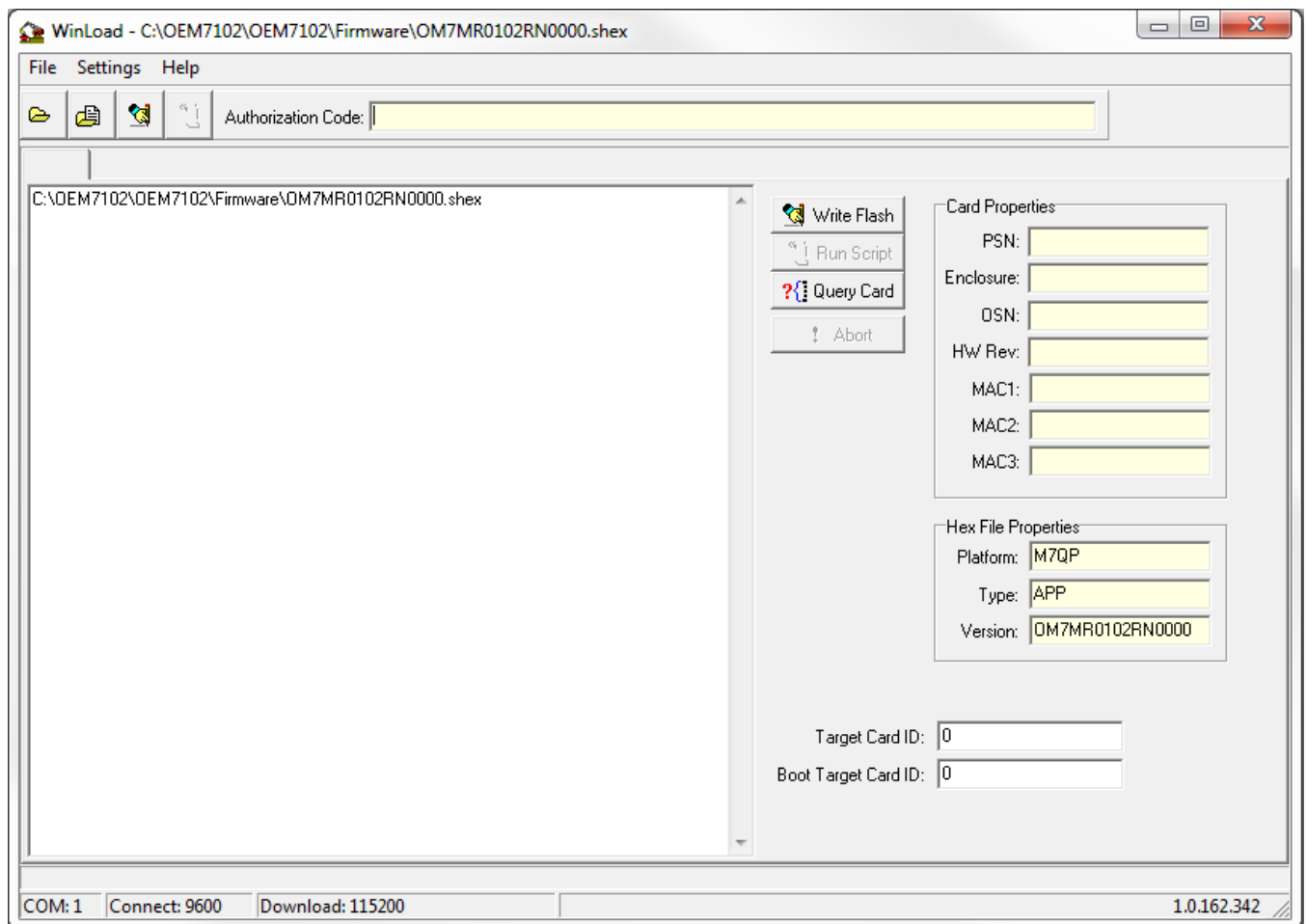


**Figure 32: WinLoad's Open Window**



When a file is selected, the *filename* appears in the main WinLoad display area and in the title bar (Figure 33: Open File in WinLoad below).

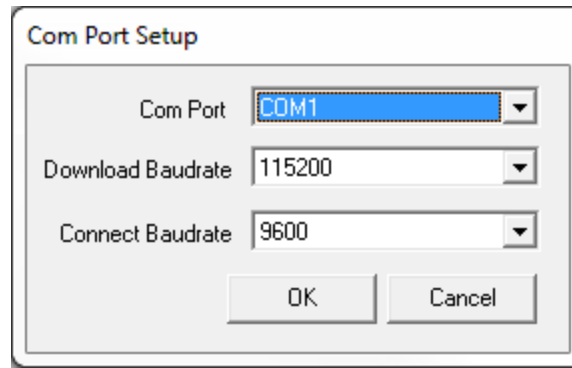
**Figure 33: Open File in WinLoad**



## Communications Settings

To set the communications port and baud rate, select Settings | COM Settings. Choose the computer port to use from the Com Port drop down list and the baud rate from the Download Baudrate drop down list. Set the baud rate as high as possible (the default of 115200 is preferred if a higher baud rate is not available).

**Figure 34: COM Port Setup**



## Downloading Firmware

1. Select the file to download according to *Open a File to Download* on page 120.
2. Ensure the file path and name are displayed in main display area (see *Figure 33: Open File in WinLoad* on the previous page).
3. Click **Write Flash** to download the firmware.
4. When *Searching for card* appears in the main display, power cycle the receiver.
5. If the Authorization Code window appears, enter the auth-code and click **OK**. See *Authorization Code* on page 119 for further information about the Authorization Code.
6. The receiver finishes the download and then resets. The process is complete when *Done* appears in the main display area.
7. Close WinLoad.



If loading a firmware that is currently installed on an OEM7 receiver (i.e. reloading the same version of firmware on a receiver), ensure that *Optimized Loading* option is unchecked in WinLoad under *Settings | Options | Optimized Loading*.

## 10.5 Updating the Firmware Using NovAtel Connect

To use NovAtel Connect to update the receiver firmware, the receiver must be connected to the computer running NovAtel Connect using a serial (COM) port, USB port or Ethernet port.

To update the firmware on the receiver:

1. Obtain the new firmware file.

See *Downloading Firmware Files* on page 120 for information about obtaining the latest version of receiver firmware.



Copy the firmware file to the computer's local drive before uploading.

2. Connect a computer to the receiver using a serial (COM) cable, USB cable or Ethernet connection.
3. Start NovAtel Connect on the computer.
4. Use NovAtel Connect to connect to the receiver.  
For information about using NovAtel Connect, refer to the help file in NovAtel Connect.
5. Click the **Firmware Update** button.  
The Update window appears.
6. Click the **CHOOSE FILE** button.
7. Navigate to the directory that contains the new firmware file and select the file.
8. Click the **Open** button
9. If an Auth Code is required, enter the Auth Code in the **Auth Code** text box.
10. Click the **UPLOAD** button.

## 10.6 Updating the Firmware Using NovAtel Web UI

To use NovAtel Web UI to update the receiver firmware, the receiver must be connected to the device running Web UI using a Wi-Fi or Ethernet connection.

To update the firmware on the receiver:

1. Obtain the new firmware file.

See *Downloading Firmware Files* on page 120 for information about obtaining the latest version of receiver firmware.



Copy the firmware file to the device's local drive before uploading.

2. Use a Wi-Fi capable device (such as a laptop, tablet or smart phone) to connect to the receiver's Wi-Fi access point. The SSID and password for the receiver Wi-Fi are on a label on the receiver.
3. Open a web browser and enter any web address, for example, novatel.com (do not include "https").
4. Click or tap the Cog button.
5. Click or tap the Update button.
6. In the Firmware panel, click or tap the **CHOOSE FILE** button and navigate to the .shex file location and select the file.
7. If an Auth Code is also being applied, the Auth Code can be entered in the Auth Code field.
8. Click or tap the **UPLOAD** button. Once the upload is complete, Web UI automatically returns to the Main Window.

## 10.7 Updating Using SoftLoad Commands

Firmware can be updated on a running receiver using a process called SoftLoad. Any available communication ports on the receiver (COM, USB, ICOM, etc.) can be used. The SoftLoad process is made up of a set of commands and logs that are used to send new firmware data to a receiver and check the progress of the update. Use SoftLoad if automated loading is desired or if a connection is only possible through USB or Ethernet.

The receiver stops tracking GNSS satellites during the SoftLoad process. Do not attempt to SoftLoad when GNSS satellite tracking on the unit is required. If the unit is connected to the NovAtel Connect utility, only the Console and ASCII Message windows may remain open in the Connect Utility.

### 10.7.1 SoftLoad Commands and Logs

Refer to the [OEM7 Commands and Logs Reference Manual](#) for detailed log and command information.

Command	Description
SOFTLOADRESET	Initiate a new SoftLoad process
SOFTLOADSREC	Send an S-Record to the receiver for the SoftLoad process
SOFTLOADDATA	Send firmware image data to the receiver for the SoftLoad process
SOFTLOADCOMMIT	Complete the SoftLoad process
SOFTLOADSETUP	Send configuration information to the receiver for the SoftLoad process. This command is not required when working with a *.shex file

Log	Description
SOFTLOADSTATUS	Provides status updates for the ongoing SoftLoad process

Each command and log can be used in abbreviated ASCII, ASCII or binary format, with the exception of SOFTLOADDATA, which should only be used in binary format.

### File Types

Firmware data is stored in \*.shex files as ASCII data in the form of S-Records, based on the Motorola S-Record format. The \*.shex file includes a digital signature for the firmware.

### 10.7.2 Working With S-Records

Each S-Record has a header indicating the type of information contained in the record.

Records beginning with S0, S5 and S7 contain metadata about the firmware image, such as version information and which card types are supported by the firmware image.

#### Example S0 Record

```
S0~V~OM7MR0400RN0000
```

**Example S5 Records**

```
S50000
S503D9FE25
S5033158D5A
```

**Example S7 Records**

```
S70000
S70500000000FA
```

Records beginning with S3 contain the actual firmware image data. Aside from the header, each pair of characters forms the ASCII representation of a binary byte. The format is as follows:

<b>S3</b>	<b>LL</b>	<b>AAAAAAA</b>	<b>DDDDDDDD...DDDDDDDD</b>	<b>CC</b>
				Check Sum
			Little Endian Data. These bytes are copied into the "data" field of the <b>SOFTLOADDATA</b> command	
		4 - Byte Address. Set this as the value of "offset" in the <b>SOFTLOADDATA</b> command		
		Length. This is the hexadecimal number of character pairs to follow in the record. This value minus 4 bytes for the address and 1 byte for the check sum is copied into the "data length" field of the <b>SOFTLOADDATA</b> command		
Header				

**10.7.3 Sending Firmware Data**

C++ source code is available to provide example code of processing S-Records and converting them to NovAtel format commands, as well as providing help with the SoftLoad process. Contact [NovAtel Customer Support](#) and ask about the `srec2softload` utility.

The **SOFTLOADSREC** and **SOFTLOADDATA** commands can be used to send firmware data from \*.shex files to the receiver.

S0, S5 and S7 S-Records should be sent directly to the receiver using the **SOFTLOADSREC** command, by enclosing the S-Record in quotation marks and issuing the command to the receiver, as follows:

```
SOFTLOADSREC "<S-RECORD>"
```

S3 records can be sent individually to the receiver using the **SOFTLOADSREC** command. Alternatively, the data from an S3 record can be parsed and packaged together with data from other S3 records into a binary **SOFTLOADDATA** command. Packaging data parsed from multiple S3 records into a binary **SOFTLOADDATA** command can result in improved firmware update times as each S3 record contains only a small number of bytes of firmware data. A single **SOFTLOADDATA** command can package up to 4096 bytes of firmware data from multiple S3 records, whereas a single **SOFTLOADSREC** command contains a maximum of 28 bytes of firmware data from a single S3 record.

Multiple S3 records can be packaged into a single **SOFTLOADDATA** command as long as the data from one S3 record follows immediately after the previous record. That is, the address from the current S3 record must equal the address from the previous S3 record plus the data length of the previous S3 record. If the data is not consecutive then the **SOFTLOADDATA** command can be sent with the amount of data it has packaged up to that point. Subsequent data can be packaged in a new **SOFTLOADDATA** command. Within the **SOFTLOADDATA** command, the

"offset" field remains the address of the first S3 record and the "data" and "data length" are updated to include the new data. Refer to the [OEM7 Commands and Logs Reference Manual](#) for command details.

The \*.shex file data may contain many gaps and jumps. For example, in many NovAtel \*.shex files, data for address 0x000\_00000 is stored near the very end of the file.

### Example Packaging Multiple S3 Records In A SOFTLOADDATA Command

Start a new **SOFTLOADDATA** command

```
S32100407AD48FCA63034B80F5CE0C36507DE3D8DCC0C6C0C00515D74BCACF2F2949E1
```

Address: 0x00407AD4 Num Data Bytes: 0x21 – 0x01 – 0x04 = 0x1C

```
S32100407AF04CCA4985F0F7B081E41D9B7D806C26989AE2D4E4CCBCB47C10FBFD3E43
```

Previous Address + Previous Num Bytes = 0x00407AD4 + 0x1C = 0x00407AF0

Address: 0x00407AF0 Num Data Bytes: 0x1C

Add data to existing **SOFTLOADDATA** command

```
S30D00407B0CDE0400A6374D5BFFC5
```

Previous Address + Previous Num Bytes = 0x00407AF0 + 0x1C = 0x00407B0C

Address: 0x00407B0C Num Data Bytes: 0x0D – 0x01 – 0x04 = 0x08

Add data to existing **SOFTLOADDATA** command

```
S3210000000007F0A7F1F4060000147B4000F49217813C7BB00014493F005C00000009
```

Previous Address + Previous Num Bytes = 0x00407B0C + 0x08 = 0x00407B14

Address: 0x00000000 Num Data Bytes: 0x1C

Requires new **SOFTLOADDATA** command because address does not match previous address + previous number of data bytes

Send existing **SOFTLOADDATA** command, and start a new **SOFTLOADDATA** command

```
S3210000001C80040000E001000030000000082B0100D8060000E4060000C806000063
```

Address: 0x0000001C Num Data Bytes: 0x1C

Previous Address + Previous Num Bytes = 0x00000000 + 0x1C = 0x0000001C

Add data to existing **SOFTLOADDATA** command

The **SOFTLOADDATA** command must be sent as a NovAtel binary format command.

### 10.7.4 SoftLoad Update Method

This section describes the sequence of commands that are issued to the receiver when updating using a \*.shex file.



The response for each command must be processed before sending the next command so as to determine if the command was accepted or rejected, and to wait for the receiver to complete the operation. Responses to SoftLoad commands are guaranteed to be output from the receiver within a specific time, which varies by command. Refer to specific SoftLoad command [OEM7 Commands and Logs Reference Manual](#) for more information on responses and the timeout values for SoftLoad commands.

1. Open a connection to any port on the receiver (COM, USB or ICOM) with the input and output INTERFACEMODE set to NOVATEL.

2. Request the SOFTLOADSTATUS log using the following command:

```
LOG SOFTLOADSTATUSA ONCHANGED
```

3. Initialize SoftLoad with a **SOFTLOADRESET** command. This command stops all tracking on the receiver to ensure sufficient memory is available for the loading process. An RXSTATUSEVENTA log reports a SoftLoad In Progress status.

4. Open the \*.shex firmware file.

5. Read each line of the \*.shex firmware file.

- a. Send S0, S5 and S7 S-Records directly to the receiver using the **SOFTLOADSREC** command. The S-Record must be enclosed in quotation marks:

```
SOFTLOADSREC "<S-RECORD>"
```

Data within S0 records can also be sent to the receiver by converting them to **SOFTLOADSETUP** commands. Refer to the **SOFTLOADSETUP** command in the [OEM7 Commands and Logs Reference Manual](#) for details on how to convert from S0 S-Records to **SOFTLOADSETUP** commands.

- b. S3 S-Records should be parsed and packaged into a **SOFTLOADDATA** command.

6. Send the **SOFTLOADCOMMIT** command after all data from the \*.shex file has been transferred to the receiver. The SOFTLOADSTATUS log reports the status of the loading process. Wait for a SOFTLOADSTATUS log to indicate the status is COMPLETE. The COMPLETE status or an error is guaranteed to be output from the receiver within 300 seconds from the time the **SOFTLOADCOMMIT** command was received by the receiver.

7. Send the auth code for the newly downloaded image using the **AUTH** command. This is only required if there is not already a signature auth code on the receiver as signature auth codes are maintained through a SoftLoad update. See *Authorization Code* on page 119 for details on Auth Codes.

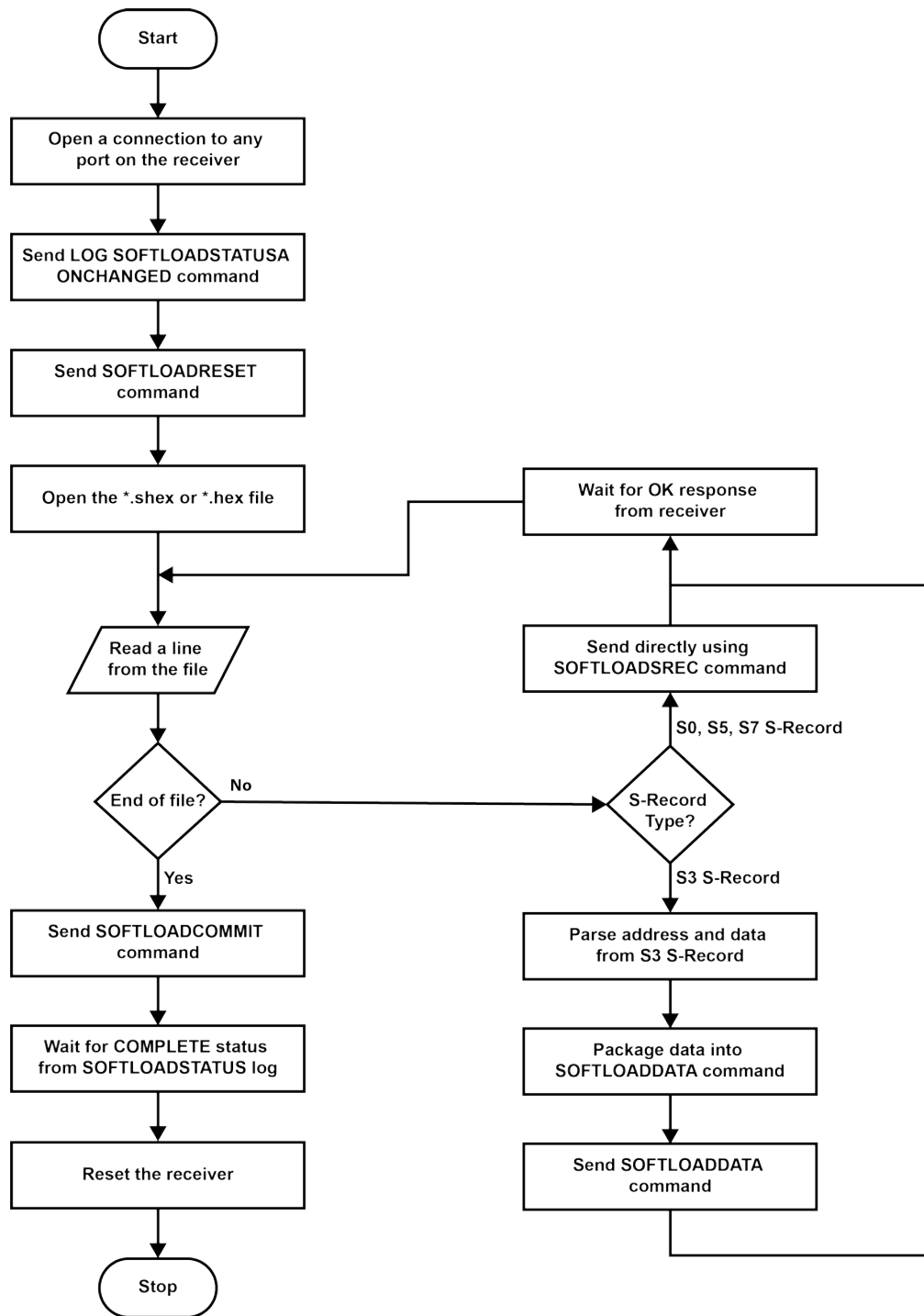
```
AUTH ADD_DOWNLOAD <AUTH CODE>
```

8. Reset the receiver using any of the following methods:

- Enter the **RESET** command
- Enter the **FRESET** command
- Power-cycle the receiver

Once the receiver resets, the new version of firmware is active.

The SoftLoad process can be safely canceled at any time using the **SOFTLOADRESET** command or by otherwise resetting the receiver. Once the COMPLETE status is reported by SOFTLOADSTATUS, the new firmware image will be run after the receiver is reset.



### 10.7.5 SoftLoad Errors

It is possible for errors to occur during the SoftLoad update. All command responses should be checked to verify all issued commands were accepted. The SoftLoad status should also be monitored in the SOFTLOADSTATUS log. Any status enum value greater than the ERROR status indicates an error has occurred during the SoftLoad update. In the event of an error, the SoftLoad update should be restarted by issuing a **SOFTLOADRESET** command or normal operation can be restored by resetting the receiver.



In rare cases after a SoftLoad error, the boot code may not be able to determine which is the latest firmware to be executed. To protect against this, SoftLoad does not erase the previous valid firmware image from flash on the receiver. In such cases, the boot code will execute the old image and raise the "Safe Mode" error (see **RXSTATUS** log). If that error is detected, simply restart the SoftLoad process to reload the new firmware image and the error will be resolved.

## 10.8 Upgrading Using an Auth-Code

An authorization code (auth-code) enables (unlocks) model features.

An auth-code can be entered using NovAtel Connect, NovAtel Web UI or the command line interface.

### 10.8.1 Entering an Auth-Code Using NovAtel Connect

1. Obtain the new auth-code from NovAtel Sales or your local NovAtel dealer.
2. Connect a computer to the receiver using a serial (COM) cable, USB cable or Ethernet connection.
3. Start NovAtel Connect on the computer.
4. Use NovAtel Connect to connect to the receiver.

For information about using NovAtel Connect, refer to the help file in NovAtel Connect.

5. Click the **Firmware Update** button.

The Update window appears.

6. Enter the auth-code in the Auth Code text box.
7. Click the **Upload** button.

### 10.8.2 Entering an Auth-Code Using NovAtel Web UI

1. Obtain the new auth-code from NovAtel Sales or your local NovAtel dealer.
2. Use a Wi-Fi capable device (such as a laptop, tablet or smart phone) to connect to the receiver's Wi-Fi access point. The SSID and password for the receiver Wi-Fi are on a label on the receiver.
3. Open a web browser and enter any web address, for example, novatel.com (do not include "https").
4. Click or tap the Cog button.
5. Click or tap the Update button.
6. In the Firmware panel, enter the auth-code in the Auth Code field.
7. Click or tap the **UPLOAD** button. Once upload complete, Web UI automatically returns to the Main Window.

### 10.8.3 Entering an Auth-Code Using the Command Line

The **AUTH** command is used to enter an auth-code. The upgrade can be performed directly through the NovAtel Connect command line or from any other communications program.



Refer to *Format of Firmware Files* on page 120 for details on updating versus upgrading.

1. Power up the OEM7 receiver and establish communications.
2. Issue the **LOG VERSION** command to verify the current model, firmware version and serial number (refer to *Authorization Code* on page 119 for instructions on obtaining).
3. Issue the **AUTH** command, followed by the auth-code and model type (refer to *Authorization Code* on page 119 for details on obtaining any auth-code). The syntax is as follows:

```
auth <your auth-code here>
```

where **auth** is a command that enables model upgrades and auth-code is the upgrade authorization code, expressed as follows:

```
XXXXXX,XXXXXX,XXXXXX,XXXXXX,XXXXXX,MODEL,EXPDATE
```

where:

- Each X character is a case-insensitive ASCII character.
- The MODEL string is a maximum of 15 characters long and represents the model enabled by the auth-code.
- The EXPDATE string is the auth-code's expiry date, in YYMMDD format

Example:

```
auth 7WBMBK,887CB6,K5J3FH,5DF5P2,42PW8G,D1SB0GTT0,121211
```

When the **AUTH** command is executed, the OEM7 receiver reboots. Issuing the **LOG VERSION** command confirms the new upgrade model type and firmware version number.

If communicating using NovAtel Connect, the communication path must be closed and reopened using the Device menu.

## 10.9 Update the Web UI

The Web UI is hosted on the OEM7 receiver. To update the Web UI, a new Web UI software package is loaded onto the receiver.



This section applies only to receivers that support the Web UI (such as the PwrPak7, SMART7 or Ethernet capable OEM7 receivers).

### 10.9.1 Update the Web UI Content Using NovAtel Connect

To update the Web UI on the receiver:

1. Obtain the new Web UI file.

The latest version of Web UI content is available on the NovAtel website ([www.novatel.com/support](http://www.novatel.com/support)).



Copy the Web UI file to the device's local drive before uploading.

2. Connect a computer to the receiver using a serial (COM) cable, USB cable or Ethernet connection.
3. Start NovAtel Connect on the computer.
4. Use NovAtel Connect to connect to the receiver.
5. Click the **Firmware Update** button.  
The Update window appears.
6. Click the **Web UI Content** tab.
7. Click the **CHOOSE FILE** button.
8. Navigate to the directory that contains the new Web UI file and select the file.
9. Click the **UPLOAD** button.

### **10.9.2 Update the Web UI Content Using Web UI**

To update the Web UI on the receiver:

1. Obtain the new Web UI file.

The latest version of Web UI content is available on the NovAtel website ([www.novatel.com/support](http://www.novatel.com/support)).



Copy the Web UI file to the device's local drive before uploading.

2. Use a Wi-Fi capable device (such as a laptop, tablet or smart phone) to connect to the receiver's Wi-Fi access point. The SSID and password for the receiver Wi-Fi are on a label on the receiver.
3. Open a web browser and enter any web address, for example, novatel.com (do not include "https").
4. Click or tap the Cog button.
5. Click or tap the Update button.
6. In the Web UI panel, click or tap the **CHOOSE FILE** button and navigate to the .shex file location and select the file.
7. Click or tap the **UPLOAD** button. Once upload complete, Web UI automatically returns to the Main Window.

# APPENDIX A PwrPak7 Technical Specifications

**Table 18: PwrPak7 Physical Description**

Size		147 mm x 125 mm x 55 mm
Weight	PwrPak7	500 grams
	PwrPak7D	500 grams
	PwrPak7-E1	510 grams
	PwrPak7D-E1	510 grams
NovAtel Part Number	PwrPak7	01019715
	PwrPak7D	01019941
	PwrPak7-E1	01019717
	PwrPak7D-E1	01019942

See the following sections for more information about the PwrPak7:

- *PwrPak7 Performance Specifications* on the next page
- *PwrPak7D Performance Specifications* on page 135
- *PwrPak7 IMU Specifications* on page 138
- *PwrPak7 Mechanical Specifications* on page 139
- *PwrPak7 Electrical and Environmental Specifications* on page 141
- *PwrPak7 Data Communication Specifications* on page 143
- *PwrPak7 Strobe Specifications* on page 145
- *PwrPak7 Connectors* on page 146

For information about the cables available for the PwrPak7, see the following:

- *PwrPak7 Power Cable* on page 149
- *PwrPak7 All I/O SPAN Cable* on page 150
- *PwrPak7 All I/O Extension Cable* on page 153
- *PwrPak7 All I/O Cable* on page 155
- *PwrPak7 COM1 Cable* on page 158
- *PwrPak7 IMU Cable* on page 159

## A.1 PwrPak7 Performance Specifications

All specifications subject to GNSS system characteristics.



These specifications apply to the PwrPak7 and PwrPak7-E1.

**Table 19: PwrPak7 Receiver Performance**

Position Accuracy <sup>1</sup>	Single point L1	1.5 m RMS
	Single point L1/L2	1.2 m RMS
	SBAS <sup>2</sup>	60 cm RMS
	DGPS	40 cm RMS
	TerraStar-L <sup>3, 4</sup>	40 cm RMS
	TerraStar-C PRO	2.5 cm RMS
	RTK	1 cm + 1 ppm RMS
Signals Tracked	GPS	L1 C/A, L1C, L2C, L2P, L5
	GLONASS	L1 C/A, L2 C/A, L2P, L3, L5 <sup>5</sup>
	BeiDou	B1I, B1C, B2I, B2a, B3I
	Galileo	E1, E5 AltBOC, E5a, E5b, E6
	NavIC (IRNSS)	L5
	SBAS	L1, L5
	QZSS	L1 C/A, L1C, L2C, L5, L6
	L-Band	Up to 5 channels <sup>6</sup>

<sup>1</sup>Typical values. All position and velocity RMS values are based on Horizontal position accuracy. Performance specifications are subject to GNSS system characteristics, Signal-in-Space (SIS) operational degradation, ionospheric and tropospheric conditions, satellite geometry, baseline length, multipath effects and the presence of intentional or unintentional interference sources.

<sup>2</sup>GPS-only.

<sup>3</sup>Requires a TerraStar subscription which is available direct from NovAtel [www.novatel.com/products/novatel-correct-ppp](http://www.novatel.com/products/novatel-correct-ppp).

<sup>4</sup>Performance dependent on local observing conditions.

<sup>5</sup>Although hardware capable, GLONASS L5 is currently not available.

<sup>6</sup>Currently the receiver can track up to 3 L-Band channels.

Time to First Fix	Hot: <26 s (Almanac and recent ephemeris saved and approximate position and time entered) Cold: <46 s (No almanac or ephemeris and no approximate position or time)			
Signal Reacquisition	<0.5 s L1 (typical) <1.0 s L2 and L5 (typical)			
Data Rates	PwrPak7	Measurements	up to 100 Hz	
		Position	up to 100 Hz	
	PwrPak7-E1	GNSS Measurements	up to 20 Hz	
		GNSS Position	up to 20 Hz	
		INS Position/Attitude	up to 200 Hz	
		IMU Raw Data Rate	125 Hz	
Time Accuracy <sup>1</sup>	20 ns RMS			
Velocity Accuracy	<0.03 m/s RMS			
Measurement Precision	GPS	L1 C/A	4 cm	0.5 mm
		L2 P(Y)	8 cm	1.0 mm
		L2C	8 cm	0.5 mm
		L5	3 cm	0.5 mm
	GLONASS	L1 C/A	8 cm	1.0 mm
		L2 P	8 cm	1.0 mm
		L2 C/A	8 cm	1.0 mm
	Galileo	E1	3 cm	0.5 mm
		E5a	3 cm	0.75 mm
		E5b	3 cm	0.75 mm
		E5 AltBoc	3 cm	0.75 mm
	BeiDou	B1I	5 cm	1.0 mm
		B2I	5 cm	1.0 mm
	Velocity Limit	515 m/s <sup>2</sup>		

<sup>1</sup>Time accuracy does not include biases due to RF or antenna delay.

<sup>2</sup>Export licensing restricts operation to a maximum of 515 metres per second, message output impacted above 500 m/s.

## A.2 PwrPak7D Performance Specifications

All specifications subject to GNSS system characteristics.



These specifications apply to the PwrPak7D and PwrPak7D-E1.

**Table 20: PwrPak7D Receiver Performance**

Position Accuracy <sup>1</sup>	Single point L1	1.5 m RMS
	Single point L1/L2	1.2 m RMS
	SBAS <sup>2</sup>	60 cm RMS
	DGPS	40 cm RMS
	TerraStar-L <sup>3, 4</sup>	40 cm RMS
	TerraStar-C PRO <sup>3, 4</sup>	2.5 cm RMS
	RTK	1 cm + 1 ppm RMS
Signals Tracked Primary Antenna	GPS	L1 C/A, L1C, L2C, L2P, L5
	GLONASS	L1 C/A, L2 C/A, L2P, L3, L5 <sup>5</sup>
	BeiDou	B1I, B1C, B2I, B2a
	Galileo	E1, E5 AltBOC, E5a, E5b
	NavIC (IRNSS)	L5
	QZSS	L1 C/A, L1C, L2C, L5
	SBAS	L1, L5
	L-Band	Up to 5 channels <sup>6</sup>

<sup>1</sup>Typical values. All position and velocity RMS values are based on Horizontal position accuracy. Performance specifications are subject to GNSS system characteristics, Signal-in-Space (SIS) operational degradation, ionospheric and tropospheric conditions, satellite geometry, baseline length, multipath effects and the presence of intentional or unintentional interference sources.

<sup>2</sup>GPS-only.

<sup>3</sup>Requires a TerraStar subscription which is available direct from NovAtel [www.novatel.com/products/novatel-correct-ppp](http://www.novatel.com/products/novatel-correct-ppp).

<sup>4</sup>Performance dependent on local observing conditions.

<sup>5</sup>Although hardware capable, GLONASS L5 is currently not available.

<sup>6</sup>Currently the receiver can track up to 3 L-Band channels.

Signals Tracked Secondary Antenna	GPS	L1 C/A, L1C, L2C, L2P, L5	
	GLONASS	L1 C/A, L2 C/A, L2P, L3, L5	
	BeiDou	B1I, B1C, B2I, B2a	
	Galileo	E1, E5 AltBOC, E5a, E5b	
	NavIC (IRNSS)	L5	
	QZSS	L1 C/A, L1C, L2C, L5	
Time to First Fix	Hot: <26 s (Almanac and recent ephemeris saved and approximate position and time entered) Cold: <46 s (No almanac or ephemeris and no approximate position or time)		
Signal Reacquisition	<0.5 s L1 (typical) <1.0 s L2 and L5 (typical)		
Data Rates	PwrPak7D	Measurements	up to 100 Hz
		Position	up to 100 Hz
	PwrPak7D-E1	GNSS Measurements	up to 20 Hz
		GNSS Position	up to 20 Hz
		INS Position/Attitude	up to 200 Hz
		INS Raw Data Rate	up to 125 Hz
Time Accuracy <sup>1</sup>	20 ns RMS		
Velocity Accuracy	<0.03 m/s RMS		

<sup>1</sup>Time accuracy does not include biases due to RF or antenna delay.



		Code	Carrier	
Measurement Precision	GPS	L1 C/A	4 cm	0.5 mm
		L2 P(Y)	8 cm	1.0 mm
		L2C	8 cm	0.5 mm
		L5	3 cm	0.5 mm
	GLONASS	L1 C/A	8 cm	1.0 mm
		L2 P	8 cm	1.0 mm
		L2 C/A	8 cm	1.0 mm
	Galileo	E1	3 cm	0.5 mm
		E5a	3 cm	0.75 mm
		E5b	3 cm	0.75 mm
		E5 AltBOC	3 cm	0.75 mm
	BeiDou	B1I	5 cm	1.0 mm
		B2I	5 cm	1.0 mm
	ALIGN Heading Accuracy	Baseline = 2 m	0.08 degrees	
Baseline = 4 m		0.05 degrees		
Velocity Limit	515 m/s <sup>1</sup>			

<sup>1</sup>Export licensing restricts operation to a maximum of 515 metres per second, message output impacted above 500 m/s.

## A.1 PwrPak7 IMU Specifications



These specifications apply to PwrPak7 models with an integrated IMU (PwrPak7-E1 and PwrPak7D-E1).



IMU specifications are provided by the Seiko Epson Corporation.

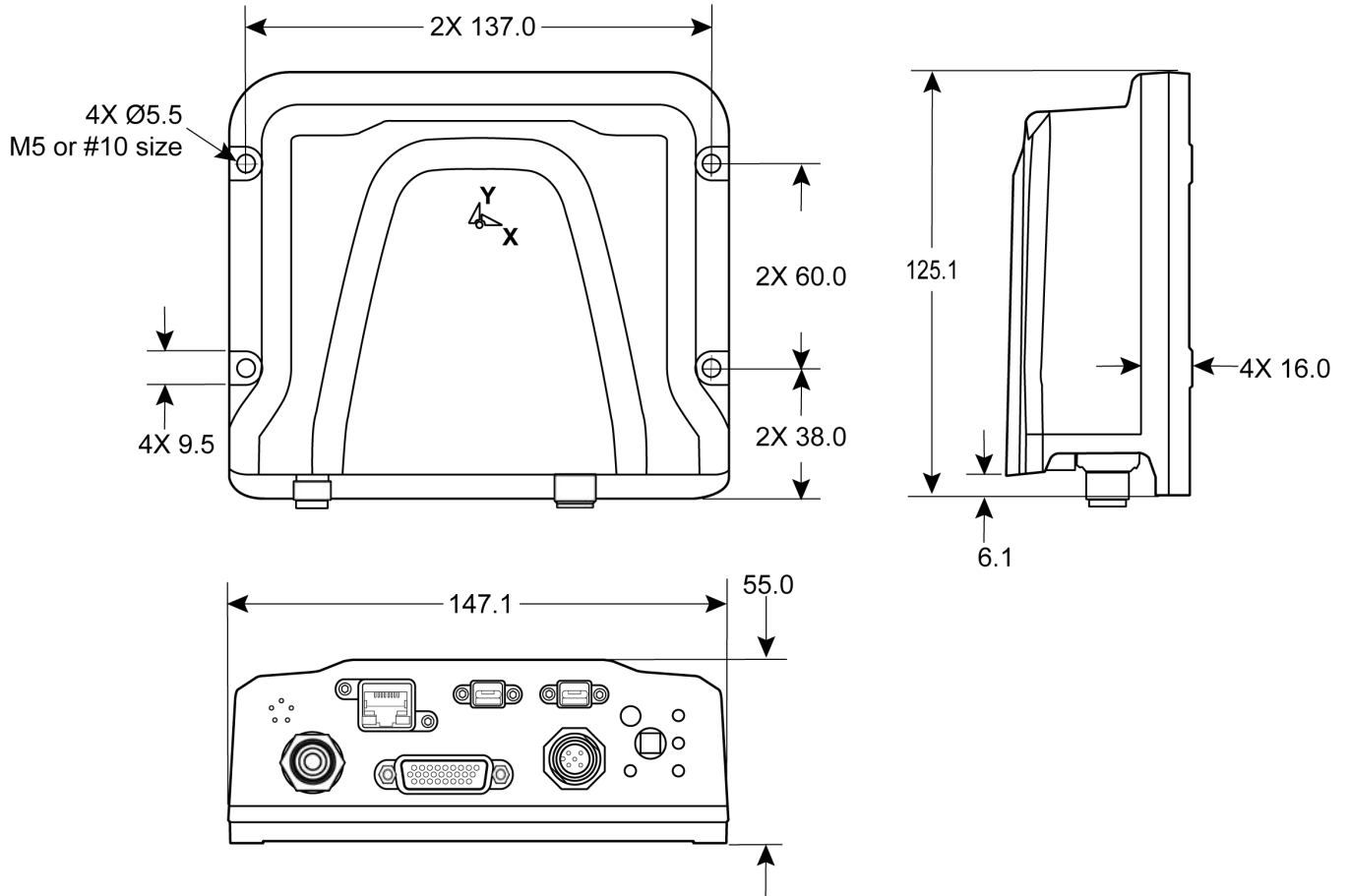
**Table 21: PwrPak7-E1 and PwrPak7D-E1 IMU Performance**

<b>Gyroscope Performance</b>	
Input Rate (max)	$\pm 150$ °/second
Bias Repeatability	0.5 °/second
Rate Bias Stability	3.5 °/hour
Angular Random Walk	0.1 °/ $\sqrt{\text{hour}}$
<b>Accelerometer Performance</b>	
Accelerometer Range	$\pm 5$ g
Bias Repeatability	15 mg
Bias Stability	0.1 mg
Velocity Random Walk	0.05 m/s/ $\sqrt{\text{hour}}$

### A.3 PwrPak7 Mechanical Specifications

- Figure 35: PwrPak7 Dimensions below
- Figure 36: PwrPak7-E1 Center of Navigation on the next page

**Figure 35: PwrPak7 Dimensions**

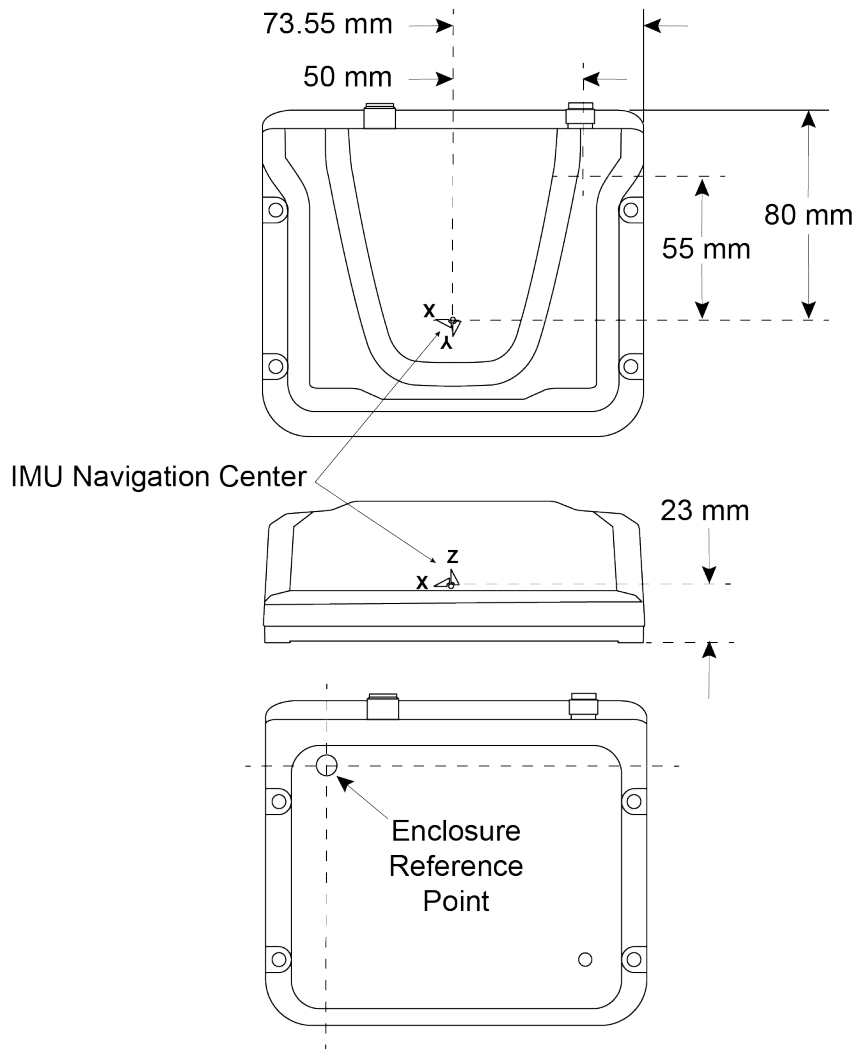


Dimensions are in millimetres.



The following diagram applies to PwrPak7-E1 and PwrPak7D-E1.

**Figure 36: PwrPak7-E1 Center of Navigation**




## A.4 PwrPak7 Electrical and Environmental Specifications

**Table 22: PwrPak7 Environmental Specifications**

Operating Temperature	-40°C to +75°C
Storage Temperature	-40°C to +85°C
Humidity	95% non-condensing
Water Resistance	IEC 60529 IPX7
Dust Resistance	IEC 60529 IP6X
Random Vibration	MIL-STD-810G (CH1), Method 514.7, Category 24 (20 g RMS)
Sinusoidal Vibration	IEC 60068-2-6
Bump	IEC 60068-2-27 (25 g)
Shock – operating	MIL-STD-810G (CH1), Method 516.7 (40 g)
Acceleration	MIL-STD-810G (CH1), Method 513.7 (16 g)

**Table 23: PwrPak7 Power Requirements**

Voltage	+9 to +36 VDC
Power Consumption	1.8 W typical, all constellations, all frequencies, plus L-Band <div style="border: 1px solid black; padding: 5px; margin-top: 10px;">  These are typical values using serial ports without interference mitigation. These values can change with the number of satellites in view, firmware version, data logging rates and features in use. Use them as a guide for what you might expect but not as absolute values </div>
Inrush Current	1.5 A for less than 1.3 ms (@ 12 V; typical)

**Table 24: PwrPak7 RF Input/LNA Power Output**

Antenna Connector	PwrPak7 PwrPak7-E1	TNC female, 50 Ω nominal impedance
	PwrPak7D PwrPak7D-E1	SMA female, 50 Ω nominal impedance
Cascaded antenna LNA gain (before receiver)	HDR disabled	+15 dB to + 40 dB, 26 dB typical
	HDR enabled	+20 dB to + 40 dB, 30 dB typical

RF Input Frequencies	GPS L1:	1575.42 MHz
	GPS L2:	1227.60 MHz
	GPS L5:	1176.45 MHz
	GLONASS L1:	1593-1610 MHz
	GLONASS L2:	1237-1254 MHz
	GLONASS L3:	1202.025 MHz
Galileo E1:	Galileo E1:	1575.42 MHz
	Galileo E5a:	1176.45 MHz
	Galileo E5b:	1207.14 MHz
	Galileo E5:	1191.795 MHz
	Galileo E6: <sup>1</sup>	1278.75 MHz
BeiDou B1I:	BeiDou B1I:	1561.098 MHz
	BeiDou B1C:	1575.42 MHz
	BeiDou B2I:	1207.14 MHz
	BeiDou B2a:	1176.45 MHz
	BeiDou B3I: <sup>2</sup>	1268.52 MHz
L-Band:	1525 to 1560 MHz	
LNA Power	+5.0 VDC ±5%, 0 mA to 200 mA (supplied by receiver through center conductor of RF connector).	

**Table 25: PwrPak7 Wheel Sensor Input Signal Levels**

	Minimum	Maximum
<b>Input<sub>Low</sub></b>	0.0 V	0.8 V
<b>Input<sub>High</sub></b>	2.0 V	13.0 V

<sup>1</sup>Galileo E6 is available on the PwrPak7 and PwrPak7-E1 only.

<sup>2</sup>BeiDou B3I is available on the PwrPak7 and PwrPak7-E1 only.

## A.5 PwrPak7 Data Communication Specifications

**Table 26: Data Communications Interfaces**

<b>COM1</b>	
Electrical format	RS-232/RS-422
Data rates <sup>1</sup>	2400, 4800, 9600 (default), 19200, 38400, 57600, 115200, 230400 or 460800 bit/s.
Signals supported	COM1_Tx, COM1_Rx, COM1_RTS, COM1_CTS
PwrPak7 port	DSUB HD26
<b>COM2</b>	
Electrical format	RS-232/RS-422
Data rates <sup>1</sup>	2400, 4800, 9600 (default), 19200, 38400, 57600, 115200, 230400 or 460800 bit/s.
Signals supported	COM2_Tx, COM2_Rx
PwrPak7 port	DSUB HD26
<b>COM3</b>	
Electrical format	RS-232
Data rates <sup>1</sup>	2400, 4800, 9600 (default), 19200, 38400, 57600, 115200, 230400 or 460800 bit/s.
Signals supported	COM3_Tx, COM3_Rx
PwrPak7 port	DSUB HD26
<b>CAN Bus</b>	
Electrical Format	ISO 11898-2
Data rates	1 Mbps maximum. CAN Bus throughput is determined by slowest device on the bus
PwrPak7 port	DSUB HD26
<b>USB</b>	
Electrical format	Conforms to USB 2.0
Data rates	Hi-speed (480 Mb/s)

<sup>1</sup>Data rates higher than 115200 bit/s are not supported by standard PC hardware. Special PC hardware may be required for higher rates, including 230400 bit/s and 460800 bit/s.

PwrPak7 port	COM PORTS - USB device TRANSFER - USB host
<b>ETHERNET</b>	
Physical layer	10BASE-T/100BASE-TX
PwrPak7 port	RJ45
<b>Wi-Fi Access Point</b>	
Security	WPA2
Encryption	AES



## A.6 PwrPak7 Strobe Specifications

All of the PwrPak7 strobe signals are available on the 26 pin D-SUB high density connector.

**Table 27: PwrPak7 Strobes Description**

Strobes	Input/Output	Factory Default	Comment
EVENT_IN1 EVENT_IN2 EVENT_IN3	Input Leading edge triggered	Active low	Input marks for which a pulse greater than 150 ns triggers certain logs to be generated. (Refer to the MARKPOS and MARKTIME logs and ONMARK trigger.) Polarity is configurable using the <b>MARKCONTROL</b> command.
EVENT_OUT1 EVENT_OUT2 EVENT_OUT3	Output	Active low	Programmable variable frequency outputs ranging from 0 Hz to 50 MHz (refer to the <b>EVENTOUTCONTROL</b> command). <b>Note:</b> EVENT_OUT1 can also be controlled by the <b>FREQUENCYOUT</b> command.
PPS	Output	Active low	A time synchronization output. This is a pulse where the leading edge is synchronized to receiver calculated GNSS Time. The polarity, period and pulse width can be configured using the <b>PPSCONTROL</b> command

**Table 28: PwrPak7 Strobe Electrical Specifications**





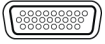


Strobe	Sym	Min (V)	Max (V)	Current (mA)
EVENT_IN1 EVENT_IN2 EVENT_IN3	$V_{IL}$ $V_{IH}$	- 2.0	0.8 6.0	<±1 mA
EVENT_OUT1 EVENT_OUT2 EVENT_OUT3	$V_{OL}$ $V_{OH}$	- 2.0	0.4 3.3	±6 mA
PPS	$V_{OL}$ $V_{OH}$	- 2.0	0.4 3.3	±6 mA

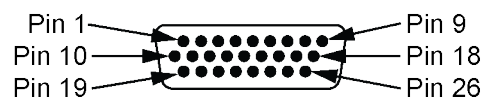


All signal I/O are at LVCMOS levels.

## A.7 PwrPak7 Connectors

**Table 29: PwrPak7 Connectors**

Connector	Label	Connector Type	Description
	ANT	TNC	Connects the receiver to the GNSS antenna (PwrPak7 and PwrPak7-E1)
	ANT 1	SMA	Connects the receiver to the primary GNSS antenna (PwrPak7D and PwrPak7D-E1)
	ANT 2	SMA	Connects the receiver to the secondary GNSS antenna (PwrPak7D and PwrPak7D-E1)
	COM PORTS	RJ45	Connects the receiver to an Ethernet network Used to communicate to the receiver using a network connection
		USB Micro A/B	A USB 2.0 port used to communicate from a computer to the receiver using a USB cable
		DSUB HD26	Provides access to communication signals on the receiver. This includes: <ul style="list-style-type: none"> <li>• 3 Event inputs (LVCMOS)</li> <li>• 3 Event outputs (LVCMOS)</li> <li>• 1 Pulse Per Second output (LVCMOS)</li> <li>• 1 CAN bus</li> <li>• 3 serial ports                             <ul style="list-style-type: none"> <li>• COM1 RS-422/RS-232 user selectable</li> <li>• COM2 RS-422/RS-232 user selectable</li> <li>• COM3 RS-232</li> </ul> </li> <li>• Wheel Sensor RS-422 Quadrature Input</li> </ul>
	TRANSFER	USB Micro A/B	USB 2.0 port used to transfer files from the on board memory to a USB stick or computer
	PWR	SAL M12 5 pin	Connects the receiver to the power supply



**Table 30: 26 Pin D-SUB High Density Pin Out**

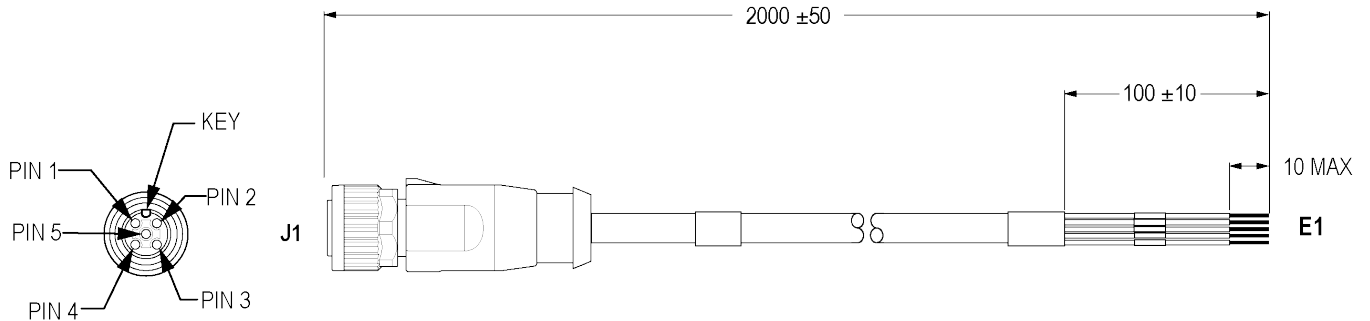
Pin	Signal Name	Description
1	COM1_RTS/ COM1_TX-	When COM1 is set to RS-232, this is the Request To Send flow control signal. When COM1 is set to RS-422, this is one half of the COM1 RS-422 transmit differential pair.
2	COM1_TX/ COM1_TX+	When COM1 is set to RS-232, this is the COM1 transmit signal. When COM1 is set to RS-422, this is one half of the COM1 transmit differential pair.
3	COM1_RX COM1_RX+	When COM1 is set to RS-232, this is the COM1 receive signal. When COM1 is set to RS-422, this is one half of the COM1 receive differential pair.
4	COM1_CTS COM1_RX-	When COM1 is set to RS-232, this is the COM1 Clear to Send flow control signal. When COM1 is set to RS-422, this is one half of the COM1 receive differential pair.
5	Wheel Sensor A+	Signal A+ from the Distance Measurement Instrument
6	Wheel Sensor A-	Signal A- from the Distance Measurement Instrument
7	Wheel Sensor B+	Signal B+ from the Distance Measurement Instrument
8	Wheel Sensor B-	Signal B- from the Distance Measurement Instrument
9	CAN_H	CAN bus port
10	COM2_TX COM2_TX+	When COM2 is set to RS-232, this is the COM2 transmit signal. When COM2 is set to RS-422, this is one half of the COM2 transmit differential pair.
11	GND	Ground reference
12	COM2_RX-	One half of the RS-422 COM2 receive differential pair.
13	COM3_TX	COM3 transmit signal
14	GND	Ground reference
15	EVENT_IN3	EVENT3 (Mark3) input
16	EVENT_OUT1	EVENT1 (Mark1) output
17	GND	Ground reference

Pin	Signal Name	Description
18	CAN_L	CAN bus port
19	COM2_TX-	One half of the COM2 transmit differential pair.
20	COM2_RX COM2_RX+	When COM2 is set to RS-232, this is the COM2 receive signal. When COM2 is set to RS-422, this is one half of the COM2 transmit differential pair.
21	COM3_RX	COM3 receive signal
22	EVENT_IN1	EVENT1 (Mark1) input
23	EVENT_IN2	EVENT2 (Mark2) input
24	PPS	Pulse Per Second output (Timemark)
25	EVENT_OUT2	EVENT2 (Mark2) output
26	EVENT_OUT3	EVENT3 (Mark3) output

## A.8 PwrPak7 Power Cable

The NovAtel part number for the PwrPak7 Power Cable is 01019764. This cable provides power to the receiver from an external power source.

**Figure 37: PwrPak7 Power Cable**



Dimensions are in millimetres.

**Table 31: PwrPak7 Power Cable Pinout**

J1 Pinout M12	Label on Lead
1	-VIN
2	+VIN_A
3	+VIN_B
4	-VIN
5	Chassis GND



Connect Pin 5 (Chassis GND) to -VIN.

A commercial version of the PwrPak7 power cable is available from several vendors. See the following table for information about this cable.

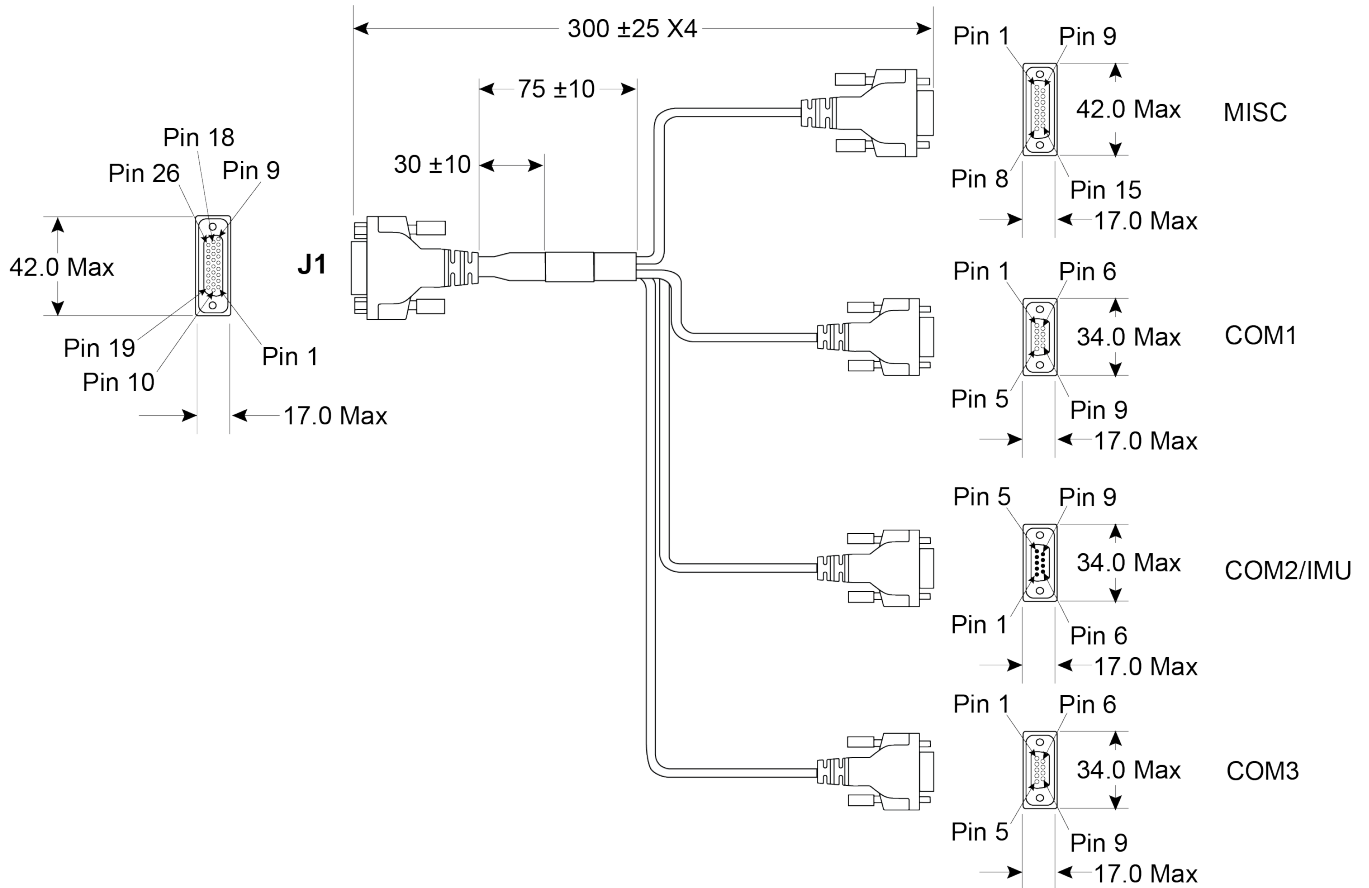
**Table 32: Commercial Power Cable**

Connector	Description	Maker	Commercial Part Number
PWR	Female connector M12x1 axial with 2m cable	CONEC	43-10052

## A.9 PwrPak7 All I/O SPAN Cable

The NovAtel part number for the PwrPak7 All I/O cable is 01020004. This cable provides access to all of the signals available on the PwrPak7 26 pin D-SUB connector.

**Figure 38: PwrPak7 All I/O SPAN Cable**



Dimensions are in millimetres.

**Table 33: PwrPak7 All I/O SPAN Cable Pinout**

Signal Name	PwrPak7 HD26 Female	MISC DB15 Female	COM1 DB9 Female	COM2/IMU DB9 Male	COM3 DB9 Female
CAN+	9	1			
CAN-	18	2			

<b>Signal Name</b>	<b>PwrPak7 HD26 Female</b>	<b>MISC DB15 Female</b>	<b>COM1 DB9 Female</b>	<b>COM2/IMU DB9 Male</b>	<b>COM3 DB9 Female</b>
PPS	24	3			
	11	5			
EVENT_IN1	22	4			
	11	5			
EVENT_IN2	23	6			
	11	8			
EVENT_IN3	15	7			
	11	8			
EVENT_OUT2	25	9			
	14	11			
EVENT_OUT3	26	10			
	14	11			
Wheel Sensor A+	5	12			
Wheel Sensor A-	6	13			
Wheel Sensor B+	7	14			
Wheel Sensor B-	8	15			
COM1_RTS/422TX-	1		8		
COM1_TXD/422TX+	2		2		
COM1_RXD/422RX+	3		3		
COM1_CTS/422RX-	4		7		
COM1_GND	14		5		
COM2_422TX-	19			7	
COM2_TXD/422TX+	10			3	
COM2_RXD/422RX+	20			2	
COM2_422RX-	12			8	
COM2_GND	17			5	

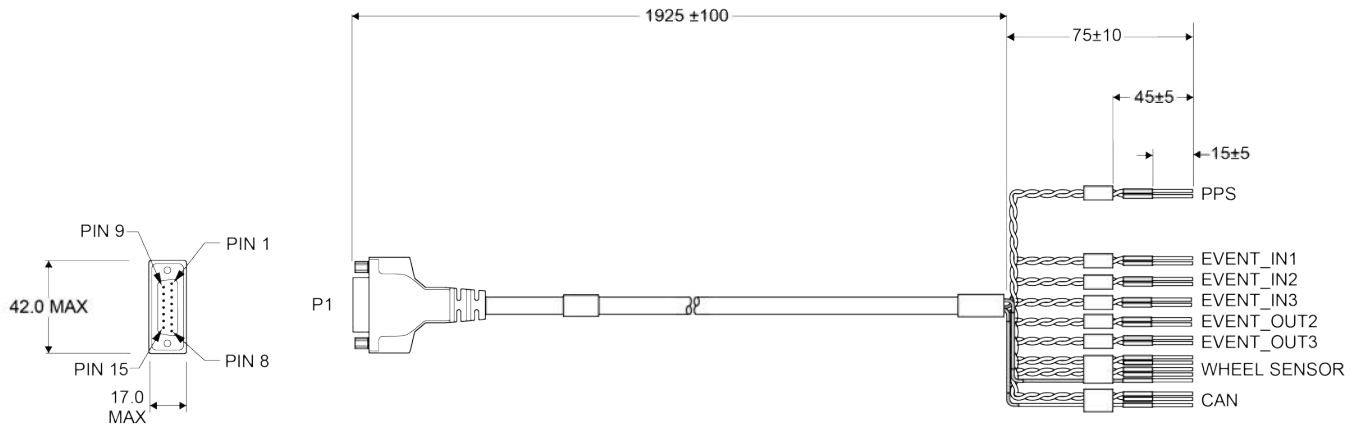
<b>Signal Name</b>	<b>PwrPak7 HD26 Female</b>	<b>MISC DB15 Female</b>	<b>COM1 DB9 Female</b>	<b>COM2/IMU DB9 Male</b>	<b>COM3 DB9 Female</b>
EVENT_OUT1	16			1	
COM3_TXD	13				2
COM3_RXD	21				3
COM3-GND	17				5



## A.10 PwrPak7 All I/O Extension Cable

The NovAtel part number for the PwrPak7 All I/O Extension Cable is 01020005. This cable is an accessory for the PwrPak7 ALL I/O SPAN cable (01020004). It connects to the MISC connector on the PwrPak7 All I/O SPAN cable and provides individual leads for all of the signals available on the MISC connector.

**Figure 39: PwrPak7 All I/O Extension Cable**



Dimensions are in millimetres.

**Table 34: PwrPak7 All I/O Extension Cable Pinout**

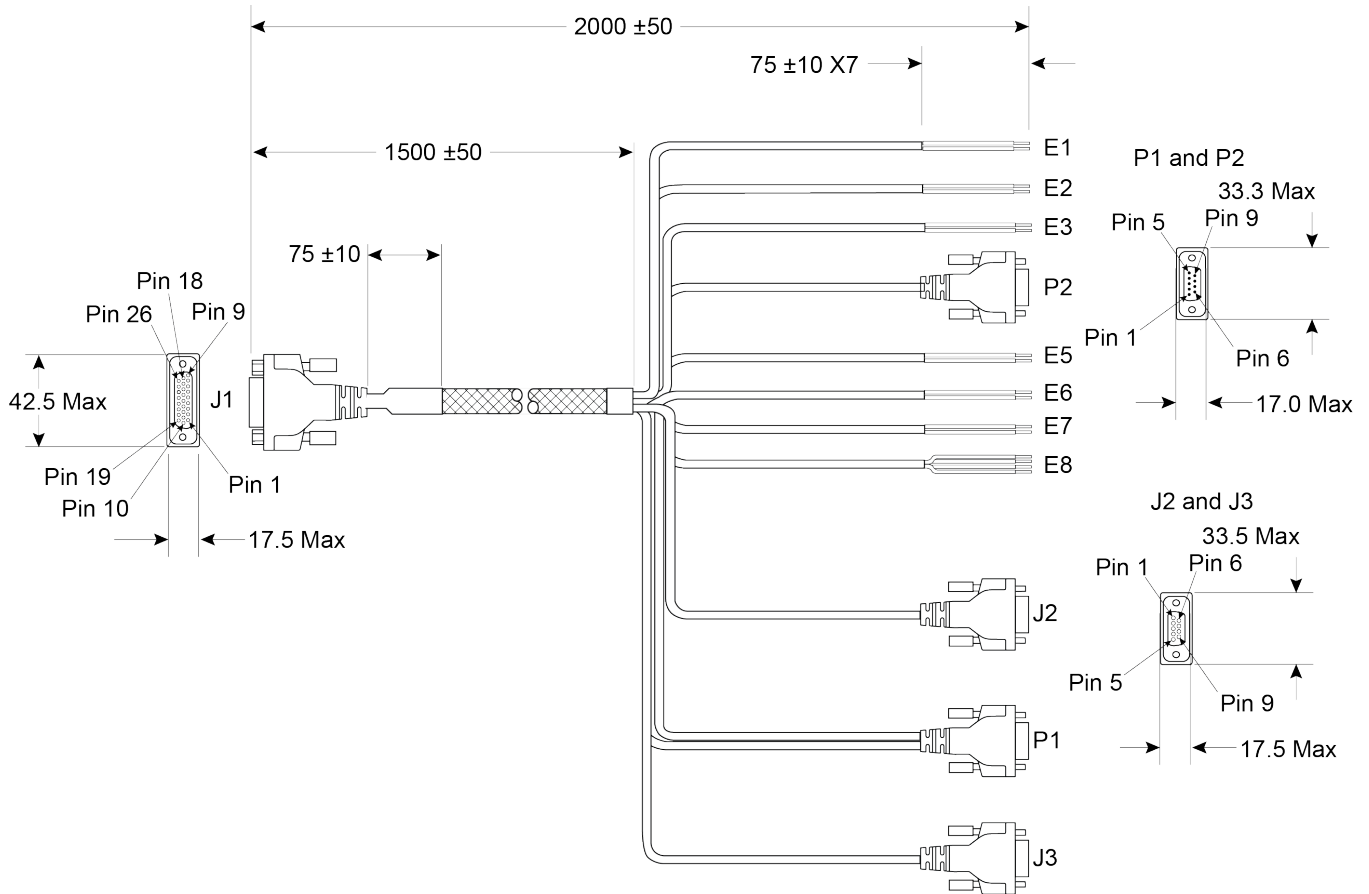
Label on Lead	P1 Connector DB15 Male
CAN+	1
CAN-	2
CAN GND	8
PPS	3
PPS_GND	5
EVENT_IN1	4
EVENT_IN1_GND	5
EVENT_IN2	6

<b>Label on Lead</b>	<b>P1 Connector DB15 Male</b>
EVENT_IN2_GND	8
EVENT_IN3	7
EVENT_IN3_GND	8
EVENT_OUT2	9
EVENT_OUT2_GND	11
EVENT_OUT3	10
EVENT_OUT3_GND	11
Wheel Sensor A+	12
Wheel Sensor A-	13
Wheel Sensor B+	14
Wheel Sensor B-	15
Wheel Sensor GND	11

## A.11 PwrPak7 All I/O Cable

The NovAtel part number for the PwrPak7 All I/O cable is 01019766. This cable provides access to all of the signals available on the PwrPak7 26 pin D-SUB connector.

**Figure 40: PwrPak7 All I/O Cable**



Dimensions are in millimetres.

**Table 35: PwrPak7 All I/O Cable Pinout**

Signal Name	J1 PwrPak7 HD26 Female	Labels on Flying Leads E1 to E8	P2 EVENT_ IN2 DB9 Male	J2 COM1 DB9 Female	P1 COM2/IMU DB9 Male	J3 COM3 DB9 Female
CAN+	9	CAN+				
CAN-	18	CAN-				

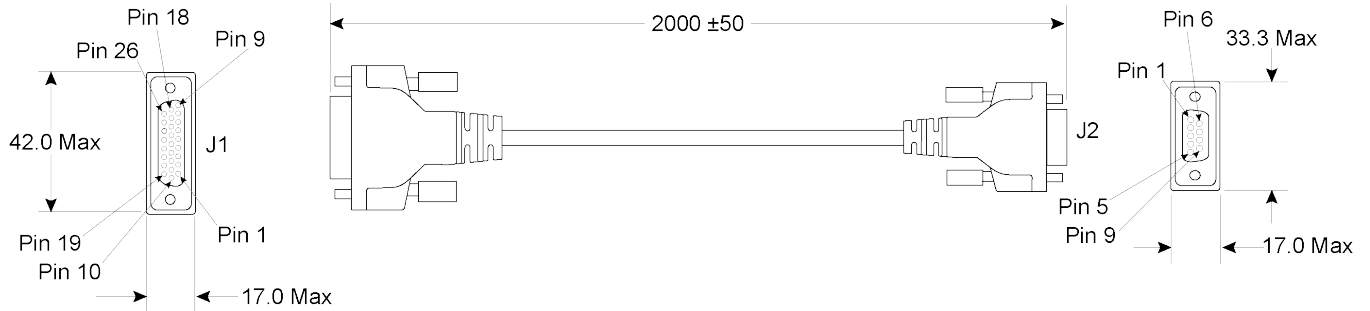
Signal Name	J1 PwrPak7 HD26 Female	Labels on Flying Leads E1 to E8	P2 EVENT_ IN2 DB9 Male	J2 COM1 DB9 Female	P1 COM2/IMU DB9 Male	J3 COM3 DB9 Female
PPS	24	PPS				
	11	PPS_GND				
EVENT_IN1	22	EVENT_IN1				
	11	EVENT_IN1_ GND				
EVENT_IN2	23		6			
EVENT_IN2_GND	11		9			
EVENT_IN3	15	EVENT_IN3				
	11	EVENT_IN3_ GND				
EVENT_OUT2	25	EVENT_OUT2				
	14	EVENT_OUT2_ GND				
EVENT_OUT3	26	EVENT_OUT3				
	14	EVENT_OUT3_ GND				
Wheel Sensor A+	5	WHEEL SENSOR A+				
Wheel Sensor A-	6	WHEEL SENSOR A-				
Wheel Sensor B+	7	WHEEL SENSOR B+				
Wheel Sensor B-	8	WHEEL SENSOR B-				
COM1_ RTS/422TX-	1			8		
COM1_ TXD/422TX+	2			2		

<b>Signal Name</b>	<b>J1 PwrPak7 HD26 Female</b>	<b>Labels on Flying Leads E1 to E8</b>	<b>P2 EVENT_ IN2 DB9 Male</b>	<b>J2 COM1 DB9 Female</b>	<b>P1 COM2/IMU DB9 Male</b>	<b>J3 COM3 DB9 Female</b>
COM1_ RXD/422RX+	3			3		
COM1_ CTS/422RX-	4			7		
COM1_GND	14			5		
COM2_ RTS/422TX-	19				7	
COM2_ TXD/422TX+	10				3	
COM2_ RXD/422RX+	20				2	
COM2_ CTS/422RX-	12				8	
COM2_GND	17				5	
EVENT_OUT1	16				1	
COM3_TXD	13					2
COM3_RXD	21					3
COM3_GND	17					5

## A.12 PwrPak7 COM1 Cable

The NovAtel part number for the PwrPak7 COM1 cable is 01019765. This cable provides access to the COM1 signals available on the PwrPak7 26 pin D-SUB connector.

**Figure 41: PwrPak7 COM1 Cable**



Dimensions are in millimetres.

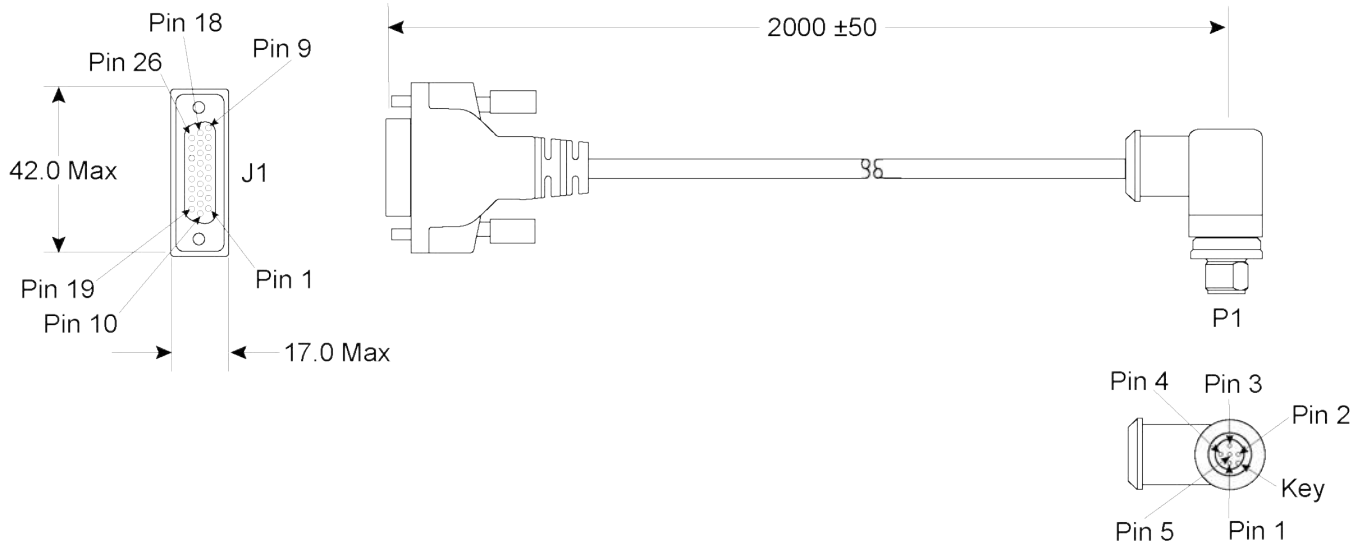
**Table 36: PwrPak7 COM1 Cable Pinout**

J1 Pinout HDB26	Function	J2 Pinout DB9
1	COM1_RTS/422TX-	8
2	COM1_TXD/422TX+	2
3	COM1_RXD/422RX+	3
4	COM1_CTS/422RX-	7
11	Ground	5
14	Ground	

### A.13 PwrPak7 IMU Cable

The NovAtel part number for the PwrPak7 IMU cable is 01019767. This cable provides a communication link between COM1 on a PwrPak7 and an IMU in the IMU Enclosure (IMU-ISA-100C, IMU-ENC-LN200, IMU-HG1900 and IMU-μIMU-IC).

**Figure 42: PwrPak7 IMU Cable**



Dimensions are in millimetres.

**Table 37: PwrPak7 IMU Cable Pinout**

J1 Pinout HDB26	Function	P1 Pinout M12
1	COM1_RTS/422TX-	4
2	COM1_TXD/422TX+	2
3	COM1_RXD/422RX+	1
4	COM1_CTS/422RX-	3
11	Ground	5
14	Ground	

## APPENDIX B Accessories and Replacement Parts

The following tables list the replacement parts available for your NovAtel OEM7 receiver. For assistance or to order additional components, contact your local NovAtel dealer or Customer Support.

**Table 38: OEM7 Receivers**

<b>NovAtel Part</b>	<b>Part Description</b>
OEM719	OEM7 receiver card with OEM6 compatible 20 pin header
OEM729	OEM7 receiver card with OEM6 compatible 24 pin and 16 pin headers
OEM7600	OEM7 receiver card with high density 60 pin socket and small form factor
OEM7700	OEM7 receiver card with high density 60 pin socket
OEM7720	OEM7 receiver card with dual antenna inputs and high density 60 pin socket
PwrPak7	OEM7 enclosure with Wi-Fi and built in data storage
PwrPak7D	Dual antenna OEM7 enclosure with Wi-Fi and built-in data storage
PwrPak7-E1	Single enclosure SPAN GNSS+INS receiver with EG320N IMU, Wi-Fi and built-in data storage
PwrPak7D-E1	Single enclosure SPAN GNSS+INS receiver with dual antenna inputs, EG320N IMU, Wi-Fi and built-in data storage

**Table 39: GNSS Antennas**

<b>NovAtel Part</b>	<b>Part Description</b>
<b>High Performance Antennas</b>	
GNSS-501	GPS L1, GLONASS L1, BeiDou B1, Galileo E1 and L-Band
GNSS 502	GPS L1/L2, GLONASS L1/L2, BeiDou B1/B2, Galileo E1/E5b and L-Band
GNSS-802	GPS L1/L2, GLONASS L1/L2, BeiDou B1 and Galileo E1
GNSS-802L	GPS L1/L2, GLONASS L1/L2, BeiDou B1, Galileo E1 and L-Band
GNSS-804	GPS L1/L2, GLONASS L1/L2, BeiDou B1/B2 and Galileo E1/E5b
GNSS-804L	GPS L1/L2, GLONASS L1/L2, BeiDou B1/B2, Galileo E1/E5b and L-Band
GNSS-850	GPS L1/L2/L5, GLONASS L1/L2/L3, BeiDou B1/B2/B3, Galileo E1/E5a/E5b/E6 and L-Band
<b>Compact Antennas</b>	



NovAtel Part	Part Description
GPS-301	3.5" circular form factor (GPS L1)
GPS-302-A	ARINC-743 bolt pattern (GPS L1/L2)
GPS-302L-A	ARINC-743 bolt pattern (GPS L1/L2, GLONASS L1 and L-Band)
GNSS-302L-A	ARINC-743 bolt pattern (GPS L1/L2, GLONASS L1/L2 and L-Band)
GNSS-303L	3.5" circular form factor (GPS L1/L2/L5, GLONASS L1/L2, BeiDou B1/B2/B3, Galileo E1/E5a/E5b/E6, NavIC L5 and L-Band)
GNSS-303L-A	ARINC-743 bolt pattern (GPS L1/L2/L5, GLONASS L1/L2, BeiDou B1/B2/B3, Galileo E1/E5a/E5b/E6, NavIC L5 and L-Band)

**Table 40: PwrPak7 Cables**

NovAtel Part	Part Description
01019764	PwrPak7 Power Cable
01019765	PwrPak7 COM1 Cable
01019766	PwrPak7 All I/O Cable
01019767	PwrPak7 IMU Cable
01020004	PwrPak7 All I/O SPAN Cable
01020005	PwrPak7 All I/O Extension Cable (used with the 01020004 cable)

**Table 41: GNSS Antenna Cables**

NovAtel Part	Part Description
GPS-C006	5 metres – TNC to TNC cable
GPS-C016	15 metres – TNC to TNC cable
GPS-C032	30 metres – TNC to TNC cable
60723177	2.5 metres – SMA to TNC cable
60723178	5 metres – SMA to TNC cable

## B.1 USB Devices Supported

The embedded USB host systems on OEM7 receivers supports a limited number of USB devices. These devices are defined in the Targeted Peripheral List (TPL). *Table 42: Targeted Peripheral List for OEM7 USB Embedded Host* on the next page shows the targeted peripheral list for the host-capable OEM7 receivers (OEM7600, OEM7700/OEM7720/PwrPak7).

**Table 42: Targeted Peripheral List for OEM7 USB Embedded Host**

Class Name	Class Code	Sub Class Code	Protocol	Speed Supported
Hub	09h	0	1	High
Mass Storage	08h	06h (SCSI transparent command set)	50h (Bulk-Only Transport)	High

The devices in the following table have been tested by NovAtel and confirmed to be compatible with the USB host system on OEM7 receivers.

**Table 43: Devices Tested for OEM7 USB Embedded Host**

Class Type	Manufacturer	Model	Vendor ID	Product ID	Description	Speed
Hub	D-Link/Genesys Logic	DUB-7	05E3h	0608h	7 Port Hub 2.0	High
Mass Storage	Kingston Technology	DataTraveler 3.0	0951h	6609h	Kingston 32GB	High
Mass Storage	Kingston Technology	DataTraveler 2.0	0951h	1665h	Kingston 32GB	High
Mass Storage	Toshiba Corporation	DataTraveler 2.0	0930h	6545h	DTSE9 8GB	High
Mass Storage	Silicon Motion Technology	Teclast CoolFlash	090Ch	1000h	GHS 32GB	High
Mass Storage	Sony Corporation	Storage Media	054Ch	09C2h	Sony 8GB	High

### ***B.1.1 Restrictions on connecting mass storage devices***

- The mass storage device should not contain more than 4194304 clusters. For large capacity devices, format them with a larger allocation unit size to reduce the number of clusters.
- If the mass storage device has multiple partitions, only the first partition is mounted and used.
- If multiple mass storage devices are connected to the USB port, only the first connected device is mounted and used.
- If multiple mass storage devices are connected to the USB port during boot up, there is no way to predict which device is mounted and used.

## APPENDIX C Importance of Antenna Selection

An antenna behaves both as a spatial and frequency filter, therefore, selecting the right GNSS antenna is critical for optimizing performance. An antenna must match the receiver's capabilities and specifications, as well as meet size, weight, environmental and mechanical specifications for the intended application.

Factors to consider when choosing a GNSS antenna include:

1. Constellation and signals

Each GNSS constellation and SBAS has its own signal frequencies and bandwidths. An antenna must cover the signal frequencies transmitted by the constellation and bandwidth supported by the GNSS receiver.

2. Antenna gain

Gain is a key performance indicator of a GNSS antenna. Gain can be defined as the relative measure of an antenna's ability to direct or concentrate radio frequency energy in a particular direction or pattern. A minimum gain is required to achieve a minimum carrier-to-power-noise ratio (C/No) to track GNSS satellites. The antenna gain is directly related to the overall C/No of the navigation GNSS receivers. Hence, antenna gain helps define the tracking ability of the system.

3. Element Gain

The element gain defines how efficient the antenna element is at receiving the signals. In any signal chain, you are only as good as the weakest link, so an antenna element with low element gain might be compensated by an increased low noise amplifier gain. However, the signal-to-noise ratio or C/No is still degraded.

4. Antenna beamwidth and gain roll-off

Gain roll-off is a factor of beamwidth, and specifies how much the gain changes over the elevation angle of the antenna. From the antenna's point of view, the satellites rise from the horizon towards zenith and fall back to the horizon. The variation in gain between zenith (directly overhead) and the horizon is known as the gain roll-off. Different antenna technologies have different gain roll-off characteristics.

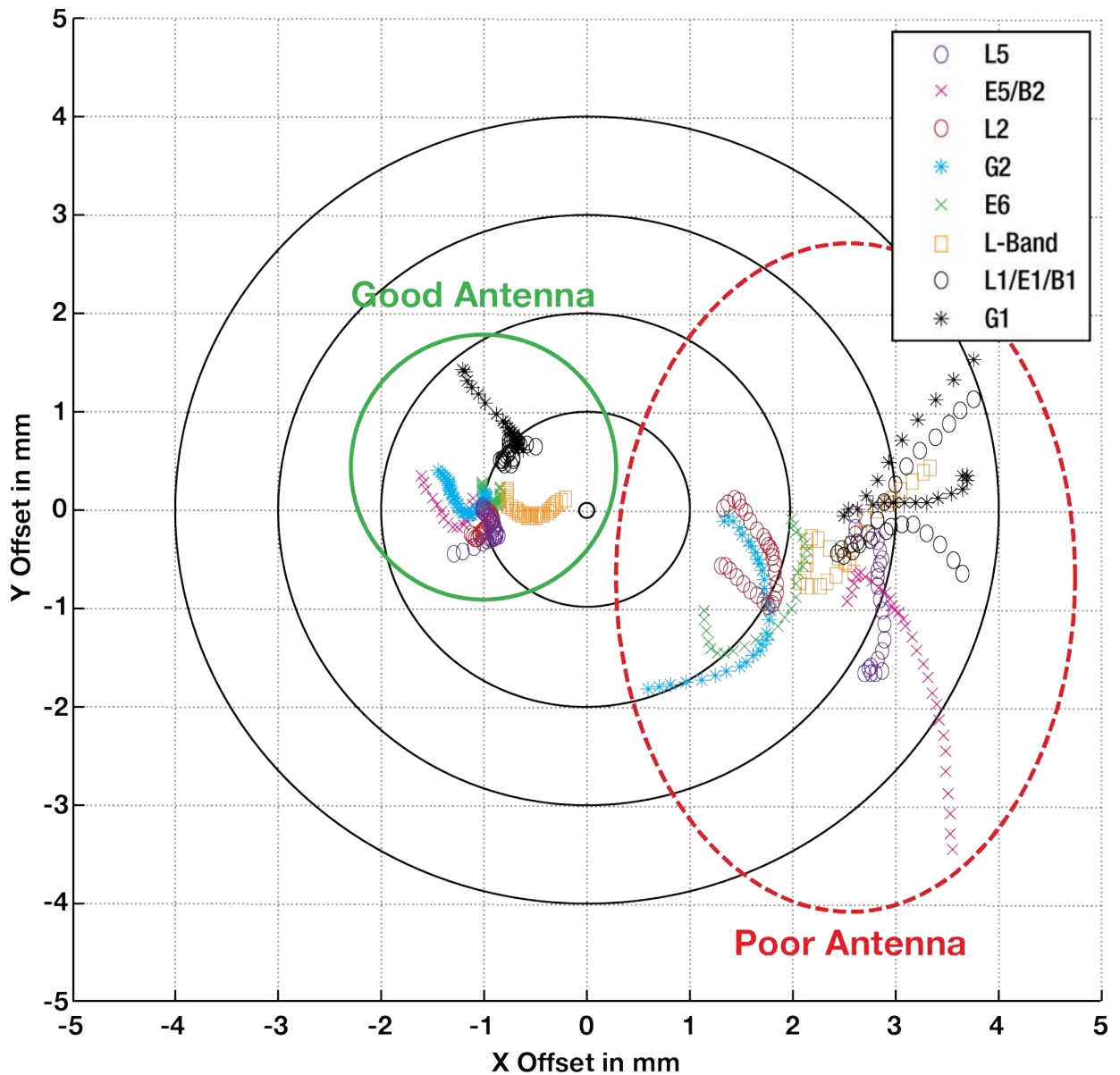
5. Phase center stability

The phase center of the antenna is the point where the signals transmitted from satellites are collected. When a receiver reports a location fix, that location is essentially the phase center of the antenna.

The electrical phase center of any antenna will vary with the position of the transmitting signal it is receiving by as much as a few millimetres. As GNSS satellites move across the sky, the electrical phase center of the signal received will typically move with the satellite position unless the antenna has been carefully designed to minimize Phase Center Offset (PCO) and Phase Center Variation (PCV).

The PCO with respect to the Antenna Reference Point (ARP) is the difference between the mechanical center of antenna rotation and electrical phase center location. The PCO is also frequency dependent which means that there can be a different offset for each signal frequency. The PCV identifies how much the phase center moves with respect to the satellite elevation angles.

**Figure 43: Plot of Good and Poor Antenna Phase Center Variation over Elevation Angle 0-90°**



Many users can accept accuracies of less than a metre so these small phase center variations cause a negligible amount of position error. But if you require high precision, Real Time Kinematic (RTK) receivers can achieve position accuracies of 2-4 cm and a few millimetres of phase center error translates to a 10-15% error in reported position. For RTK survey applications, geodetic grade antennas offer superior PCO/PCV performance.

6. The application

An antenna has to meet the performance, environmental, mechanical, and operational requirements of the intended application. For example, GNSS antennas used for aviation applications should ideally be TSO/FAA certified and be rugged enough to handle extreme

temperatures and vibration profiles. Survey rover antennas should be able to survive rough handling by surveyors including a pole drop.

The table below highlights some of the important desirable features needed for a GNSS antenna based upon the user's application.

Desirable Feature	Survey	GIS	Reference Station	Aviation/Aerial Survey	Marine	Construction/Mining	Precision Agriculture	Vehicle Tracking	Dock Operations	Unmanned Aircraft	Unmanned Vehicle	Timing
Low Profile				•		•		•		•		
Ultra-low PCO/PCV	•		•									
Low PCO/PCV		•		•		•	•			•	•	
High Vibration				•		•	•		•	•	•	
Rugged	•	•	•			•			•			
Single Frequency												•
Multi Constellation	•	•	•	•	•	•	•		•	•	•	
Multi Frequency (RTK)	•	•	•		•	•	•		•	•	•	
L-band frequency (Correction Services)					•		•					
Narrow Bandwidth												•
Weatherproof	•	•	•	•	•	•	•	•	•	•	•	•
Corrosion Resistant			•		•	•			•			•
High Multipath Suppression	•		•		•	•	•		•		•	
Pole Mount	•	•	•		•	•			•			•
Magnetic/Surface Mount						•	•	•	•		•	
TSO/FAA Certification				•						•		
Extended Temperature Range			•	•						•		
Small Form-factor/ Lightweight		•								•		
High Altitude Operation			•	•						•		

