



**OEM7<sup>®</sup>**  
**Commands and Logs**  
**Reference Manual**

---

# OEM7 Commands and Logs Reference Manual

**Publication Number:** OM-20000169

**Revision Level:** v4

**Revision Date:** February 2018

**Firmware Versions:**

- 7.04 / OM7MR0400RN0000
- PP7 01.00 / EP7PR0100RN0000

## Proprietary Notice

Information in this document is subject to change without notice and does not represent a commitment on the part of NovAtel Inc. The information contained within this manual is believed to be true and correct at the time of publication.

NovAtel, OEM7, PwrPak7, SPAN, ALIGN, GLIDE, STEADYLINE and Waypoint are registered trademarks of NovAtel Inc.

OEM719, OEM729, OEM7500, OEM7700, OEM7720, NovAtel CORRECT, RTK ASSIST and NovAtel Connect are trademarks of NovAtel Inc.

All other brand names are trademarks of their respective holders.

© Copyright 2018 NovAtel Inc. All rights reserved. Unpublished rights reserved under International copyright laws.

---

# Table of Contents

## Figures

## Tables

## Customer Support

## Foreword

## Chapter 1 Messages

|       |   |    |
|-------|---|----|
| 1.1   | ASCII .....   | 27 |
| 1.2   | Abbreviated ASCII .....                                       | 29 |
| 1.3   | Binary .....  | 29 |
| 1.4   | Description of ASCII and Binary Logs with Short Headers ..... | 42 |
| 1.5   | Message Responses .....                                       | 42 |
| 1.5.1 | Abbreviated ASCII Response .....                              | 43 |
| 1.5.2 | ASCII Response .....  | 43 |
| 1.5.3 | Binary Response .....   | 43 |
| 1.6   | GLONASS Slot and Frequency Numbers .....                      | 45 |
| 1.6.1 | PRN Numbers .....   | 46 |
| 1.7   | GPS Reference Time Status .....                               | 47 |
| 1.8   | Message Time Stamps .....                                     | 48 |
| 1.9   | Decoding of the GPS Reference Week Number .....               | 49 |
| 1.10  | 32-Bit CRC .....  | 49 |

## Chapter 2 Core Commands

|       |                           |     |
|-------|---------------------------|-----|
| 2.1   | Command Formats .....     | 52  |
| 2.1.1 | Optional Parameters ..... | 52  |
| 2.2   | Command Settings .....    | 52  |
| 2.3   | Factory Defaults .....    | 53  |
| 2.4   | Command Reference .....   | 53  |
| 2.5   | ADJUST1PPS .....          | 54  |
| 2.6   | ALIGNAUTOMATION .....     | 62  |
| 2.7   | ANTENNAPOWER .....        | 64  |
| 2.8   | ASSIGN .....              | 66  |
| 2.9   | ASSIGNALL .....           | 69  |
| 2.10  | ASSIGNLBANDBEAM .....     | 72  |
| 2.11  | AUTH .....                | 74  |
| 2.12  | AUTOSURVEY .....          | 77  |
| 2.13  | BASEANTENNAPCO .....      | 79  |
| 2.14  | BASEANTENNAPCV .....      | 81  |
| 2.15  | BASEANTENNATYPE .....     | 82  |
| 2.16  | BDSECUTOFF .....          | 93  |
| 2.17  | BESTVELTYPE .....         | 95  |
| 2.18  | CANCONFIG .....           | 96  |
| 2.19  | CCOMCONFIG .....          | 98  |
| 2.20  | CLOCKADJUST .....         | 101 |
| 2.21  | CLOCKCALIBRATE .....      | 103 |
| 2.22  | CLOCKOFFSET .....         | 106 |
| 2.23  | CNOUPDATE .....           | 107 |

---

|        |                                 |     |
|--------|---------------------------------|-----|
| 2.24   | COMCONTROL .....                | 108 |
| 2.25   | DATADECODESIGNAL .....          | 111 |
| 2.26   | DATUM .....                     | 114 |
| 2.27   | DGPSTXID .....                  | 121 |
| 2.28   | DIFFCODEBIASCONTROL .....       | 122 |
| 2.29   | DLTIMECONST .....               | 123 |
| 2.30   | DNSCONFIG .....                 | 126 |
| 2.31   | DYNAMICS .....                  | 127 |
| 2.32   | ECHO .....                      | 129 |
| 2.33   | ECUTOFF .....                   | 132 |
| 2.34   | ELEVATIONCUTOFF .....           | 134 |
| 2.35   | ETHCONFIG .....                 | 137 |
| 2.36   | EVENTINCONTROL .....            | 139 |
| 2.37   | EVENTOUTCONTROL .....           | 141 |
| 2.38   | EXTERNALCLOCK .....             | 144 |
| 2.39   | FILEAUTOTRANSFER .....          | 147 |
| 2.40   | FILECONFIG .....                | 149 |
| 2.41   | FILEDELETE .....                | 151 |
| 2.42   | FILEMEDIACONFIG .....           | 152 |
| 2.43   | FILEROTATECONFIG .....          | 153 |
| 2.44   | FILETRANSFER .....              | 156 |
| 2.45   | FIX .....                       | 158 |
| 2.46   | FIXPOSDATUM .....               | 162 |
| 2.47   | FORCEGLOL2CODE .....            | 163 |
| 2.48   | FORCEGPSL2CODE .....            | 165 |
| 2.49   | FREQUENCYOUT .....              | 167 |
| 2.50   | FRESET .....                    | 170 |
| 2.51   | GALECUTOFF .....                | 173 |
| 2.52   | GENERATEALIGNCORRECTIONS .....  | 175 |
| 2.53   | GENERATEDIFFCORRECTIONS .....   | 177 |
| 2.54   | GENERATERTKCORRECTIONS .....    | 178 |
| 2.55   | GGAQUALITY .....                | 180 |
| 2.56   | GLIDEINITIALIZATIONPERIOD ..... | 182 |
| 2.57   | GLOECUTOFF .....                | 183 |
| 2.58   | HDTOUTTHRESHOLD .....           | 185 |
| 2.59   | HEADINGOFFSET .....             | 186 |
| 2.60   | ICOMCONFIG .....                | 187 |
| 2.61   | INTERFACEMODE .....             | 189 |
| 2.61.1 | SPAN Systems .....              | 189 |
| 2.62   | IONOCONDITION .....             | 195 |
| 2.63   | IPCONFIG .....                  | 196 |
| 2.64   | IPSERVICE .....                 | 198 |
| 2.65   | ITBANDPASSCONFIG .....          | 200 |
| 2.66   | ITDETECTCONFIG .....            | 202 |
| 2.67   | ITFRONTENDMODE .....            | 204 |
| 2.68   | ITPROGFILTCONFIG .....          | 206 |
| 2.69   | ITSPECTRALANALYSIS .....        | 208 |
| 2.70   | J1939CONFIG .....               | 212 |
| 2.71   | LOCKOUT .....                   | 214 |
| 2.72   | LOCKOUTSYSTEM .....             | 215 |

---

|         |                                |     |
|---------|--------------------------------|-----|
| 2.73    | LOG .....                      | 216 |
| 2.73.1  | Binary .....                   | 218 |
| 2.73.2  | ASCII .....                    | 221 |
| 2.74    | LOGIN .....                    | 222 |
| 2.75    | LOGOUT .....                   | 224 |
| 2.76    | MAGVAR .....                   | 225 |
| 2.77    | MARKCONTROL .....              | 228 |
| 2.78    | MEDIAFORMAT .....              | 231 |
| 2.79    | MODEL .....                    | 232 |
| 2.80    | MOVINGBASESTATION .....        | 234 |
| 2.81    | NAVICECUTOFF .....             | 236 |
| 2.82    | NMEAFORMAT .....               | 238 |
| 2.83    | NMEATALKER .....               | 241 |
| 2.84    | NMEAVERSION .....              | 243 |
| 2.85    | NTRIPCONFIG .....              | 244 |
| 2.86    | NTRIPSOURCETABLE .....         | 246 |
| 2.87    | NVMRESTORE .....               | 247 |
| 2.88    | NVMUSERDATA .....              | 248 |
| 2.89    | PDPFILTER .....                | 249 |
| 2.89.1  | GLIDE Position Filter .....    | 249 |
| 2.90    | PDPMODE .....                  | 251 |
| 2.91    | PGNCONFIG .....                | 252 |
| 2.92    | POSAVE .....                   | 253 |
| 2.93    | POSTIMEOUT .....               | 255 |
| 2.94    | PPPBASICONVERGEDCRITERIA ..... | 256 |
| 2.95    | PPPCONVERGEDCRITERIA .....     | 257 |
| 2.96    | PPPDYNAMICS .....              | 258 |
| 2.97    | PPPDYNAMICSEED .....           | 259 |
| 2.98    | PPPRESET .....                 | 261 |
| 2.99    | PPPSEED .....                  | 262 |
| 2.100   | PPPSOURCE .....                | 264 |
| 2.101   | PPPTIMEOUT .....               | 266 |
| 2.102   | PPSCONTROL .....               | 267 |
| 2.103   | PPSCONTROL2 .....              | 270 |
| 2.104   | PROFILE .....                  | 273 |
| 2.105   | PSRDIFFSOURCE .....            | 275 |
| 2.106   | PSRDIFFSOURCETIMEOUT .....     | 278 |
| 2.107   | PSRDIFFTIMEOUT .....           | 279 |
| 2.108   | QZSSECUTOFF .....              | 280 |
| 2.109   | RADARCONFIG .....              | 282 |
| 2.110   | RAIMMODE .....                 | 284 |
| 2.110.1 | Detection strategy .....       | 284 |
| 2.110.2 | Isolation strategy .....       | 284 |
| 2.111   | REFERENCESTATIONTIMEOUT .....  | 286 |
| 2.112   | RESET .....                    | 287 |
| 2.113   | RFINPUTGAIN .....              | 288 |
| 2.114   | RTKANTENNA .....               | 290 |
| 2.115   | RTKASSIST .....                | 292 |
| 2.116   | RTKASSISTTIMEOUT .....         | 293 |
| 2.117   | RTKDYNAMICS .....              | 295 |

---

|       |                               |     |
|-------|-------------------------------|-----|
| 2.118 | RTKINTEGERCRITERIA            | 296 |
| 2.119 | RTKMATCHEDTIMEOUT             | 298 |
| 2.120 | RTKNETWORK                    | 299 |
| 2.121 | RTKPORTMODE                   | 302 |
| 2.122 | RTKQUALITYLEVEL               | 304 |
| 2.123 | RTKRESET                      | 305 |
| 2.124 | RTKSOURCE                     | 306 |
| 2.125 | RTKSOURCETIMEOUT              | 308 |
| 2.126 | RTKSVENTRIES                  | 309 |
| 2.127 | RTKTIMEOUT                    | 310 |
| 2.128 | SAVECONFIG                    | 311 |
| 2.129 | SAVEETHERNETDATA              | 312 |
| 2.130 | SBASCONTROL                   | 314 |
| 2.131 | SBASECUTOFF                   | 317 |
| 2.132 | SBASTIMEOUT                   | 318 |
| 2.133 | SELECTCHANCONFIG              | 319 |
| 2.134 | SEND                          | 322 |
| 2.135 | SENDHEX                       | 324 |
| 2.136 | SERIALCONFIG                  | 325 |
| 2.137 | SERIALPROTOCOL                | 328 |
| 2.138 | SETADMINPASSWORD              | 330 |
| 2.139 | SETAPPROXPOS                  | 331 |
| 2.140 | SETAPPROXTIME                 | 332 |
| 2.141 | SETBASERECEIVERTYPE           | 334 |
| 2.142 | SETBESTPOSCRITERIA            | 335 |
| 2.143 | SETDIFFCODEBIASES             | 337 |
| 2.144 | SETIONOTYPE                   | 339 |
| 2.145 | SETNAV                        | 341 |
| 2.146 | SETROVERID                    | 343 |
| 2.147 | SETTIMEBASE                   | 344 |
| 2.148 | SETTROPOMODEL                 | 346 |
| 2.149 | SETUTCLEAPSECONDS             | 347 |
| 2.150 | SOFTLOADCOMMIT                | 348 |
| 2.151 | SOFTLOADDATA                  | 349 |
| 2.152 | SOFTLOADRESET                 | 350 |
| 2.153 | SOFTLOADSETUP                 | 351 |
| 2.154 | SOFTLOADSREC                  | 353 |
| 2.155 | STATUSCONFIG                  | 354 |
| 2.156 | STEADYLINE                    | 356 |
| 2.157 | STEADYLINEDIFFERENTIALTIMEOUT | 358 |
| 2.158 | THISANTENNAPCO                | 359 |
| 2.159 | THISANTENNAPCV                | 360 |
| 2.160 | THISANTENNATYPE               | 361 |
| 2.161 | TRACKSV                       | 362 |
| 2.162 | TUNNELESCAPE                  | 364 |
| 2.163 | UALCONTROL                    | 366 |
| 2.164 | UNASSIGN                      | 368 |
| 2.165 | UNASSIGNALL                   | 370 |
| 2.166 | UNDULATION                    | 371 |
| 2.167 | UNLOCKOUT                     | 373 |

|         |                 |     |
|---------|-----------------|-----|
| 2.168   | UNLOCKOUTALL    | 374 |
| 2.169   | UNLOCKOUTSYSTEM | 375 |
| 2.170   | UNLOG           | 376 |
| 2.170.1 | Binary          | 376 |
| 2.170.2 | ASCII           | 377 |
| 2.171   | UNLOGALL        | 378 |
| 2.172   | USBSTICKEJECT   | 379 |
| 2.173   | USERDATUM       | 380 |
| 2.174   | USEREXPDATUM    | 382 |
| 2.175   | UTMZONE         | 385 |
| 2.176   | WIFIAPCHANNEL   | 387 |
| 2.177   | WIFIAPCONFIG    | 388 |
| 2.178   | WIFIAPPASSKEY   | 389 |
| 2.179   | WIFIMODE        | 390 |

### Chapter 3 Logs

|       |                    |     |
|-------|--------------------|-----|
| 3.1   | Log Types          | 391 |
| 3.1.1 | Log Type Examples  | 391 |
| 3.2   | Log Reference      | 392 |
| 3.3   | ALIGNBSLNENU       | 393 |
| 3.4   | ALIGNBSLNXYZ       | 395 |
| 3.5   | ALIGNDOP           | 397 |
| 3.6   | ALMANAC            | 398 |
| 3.7   | AUTHCODES          | 401 |
| 3.8   | AVEPOS             | 403 |
| 3.9   | BDSALMANAC         | 406 |
| 3.10  | BDSCLOCK           | 408 |
| 3.11  | BDSEPEMERIS        | 410 |
| 3.12  | BDSIONO            | 413 |
| 3.13  | BDSRAWNAV/SUBFRAME | 415 |
| 3.14  | BESTPOS            | 416 |
| 3.15  | BESTSATS           | 425 |
| 3.16  | BESTUTM            | 429 |
| 3.17  | BESTVEL            | 432 |
| 3.18  | BESTXYZ            | 435 |
| 3.19  | BSLNXYZ            | 438 |
| 3.20  | CHANCONFIGLIST     | 440 |
| 3.21  | CLOCKMODEL         | 444 |
| 3.22  | CLOCKSTEERING      | 447 |
| 3.23  | DUALANTENNAHEADING | 450 |
| 3.24  | ETHSTATUS          | 452 |
| 3.25  | FILELIST           | 453 |
| 3.26  | FILESTATUS         | 455 |
| 3.27  | FILESYSTEMCAPACITY | 457 |
| 3.28  | FILESYSTEMSTATUS   | 459 |
| 3.29  | FILETRANSFERSTATUS | 461 |
| 3.30  | GALALMANAC         | 463 |
| 3.31  | GALCLOCK           | 465 |
| 3.32  | GALFNAVEPEMERIS    | 467 |
| 3.33  | GALFNAVRAWPAGE     | 469 |

---

|        |   |     |
|--------|---|-----|
| 3.34   | GALINAVEPHEMERIS .....                                  | 470 |
| 3.35   | GALINAVRAWWORD .....                                    | 473 |
| 3.36   | GALIONO .....   | 474 |
| 3.37   | GLMLA .....   | 475 |
| 3.38   | GLOALMANAC .....  | 478 |
| 3.39   | GLOCLOCK .....  | 481 |
| 3.40   | GLOEPHEMERIS .....                                      | 483 |
| 3.41   | GLORAWALM .....   | 487 |
| 3.42   | GLORAWEPHEM .....                                       | 489 |
| 3.43   | GLORAWFRAME .....                                       | 491 |
| 3.44   | GLORAWSTRING .....                                      | 493 |
| 3.45   | GPALM .....   | 494 |
| 3.46   | GPGGA .....   | 497 |
| 3.47   | GPGGALONG .....   | 500 |
| 3.48   | GPGLL .....   | 502 |
| 3.49   | GPGRS .....   | 504 |
| 3.50   | GPGSA .....   | 506 |
| 3.51   | GPGST .....   | 508 |
| 3.52   | GPGSV .....   | 510 |
| 3.53   | GPHDT .....   | 512 |
| 3.54   | GPHDTDUALANTENNA .....                                  | 513 |
| 3.55   | GPRMB .....   | 514 |
| 3.56   | GPRMC .....   | 517 |
| 3.57   | GPSEPHM .....   | 519 |
| 3.58   | GPVTG .....   | 523 |
| 3.59   | GPZDA .....   | 525 |
| 3.60   | HEADING2 .....  | 526 |
| 3.61   | HEADINGRATE .....                                       | 529 |
| 3.62   | HEADINGSATS .....                                       | 531 |
| 3.63   | HWMONITOR .....   | 534 |
| 3.64   | IONUTC .....  | 537 |
| 3.65   | IPSTATS .....   | 539 |
| 3.66   | IPSTATUS .....  | 540 |
| 3.67   | ITBANDPASSBANK .....                                    | 542 |
| 3.68   | ITDETECTSTATUS .....                                    | 544 |
| 3.69   | ITFILTABLE .....  | 546 |
| 3.70   | ITPROGFILTBANK .....                                    | 550 |
| 3.71   | ITPSDFINAL .....  | 552 |
| 3.72   | J1939STATUS .....                                       | 555 |
| 3.73   | LBANDBEAMTABLE .....                                    | 557 |
| 3.74   | LBANDDRAWFRAME .....                                    | 559 |
| 3.75   | LBANDTRACKSTAT .....                                    | 561 |
| 3.76   | LOGLIST .....   | 564 |
| 3.76.1 | Binary .....  | 564 |
| 3.76.2 | ASCII .....   | 565 |
| 3.77   | MARK1COUNT, MARK2COUNT, MARK3COUNT and MARK4COUNT ..... | 567 |
| 3.78   | MARKPOS, MARK2POS, MARK3POS and MARK4POS .....          | 569 |
| 3.79   | MARKTIME, MARK2TIME, MARK3TIME and MARK4TIME .....      | 572 |
| 3.80   | MASTERPOS .....   | 574 |
| 3.81   | MATCHEDPOS .....  | 576 |



---

|       |   |     |
|-------|---|-----|
| 3.82  | MATCHEDSATS   | 579 |
| 3.83  | MATCHEDXYZ  | 581 |
| 3.84  | MODELFEATURES   | 583 |
| 3.85  | NAVICALMANAC  | 587 |
| 3.86  | NAVICEPHEMERIS  | 589 |
| 3.87  | NAVICIONO   | 592 |
| 3.88  | NAVICRAWSUBFRAME  | 594 |
| 3.89  | NAVICSYSCLOCK   | 595 |
| 3.90  | NAVIGATE  | 597 |
| 3.91  | NMEA Standard Logs  | 600 |
| 3.92  | NOVATELXOBS   | 603 |
| 3.93  | NOVATELXREF   | 604 |
| 3.94  | OCEANIXINFO   | 605 |
| 3.96  | OCEANIXSTATUS   | 607 |
| 3.97  | PASSCOM, PASSXCOM, PASSAUX, PASSUSB, PASSETH1, PASSICOM, PASSNCOM | 609 |
| 3.98  | PASSTHROUGH   | 614 |
| 3.99  | PDPPPOS   | 615 |
| 3.100 | PDPSATS   | 617 |
| 3.101 | PDPVEL  | 619 |
| 3.102 | PDPXYZ  | 621 |
| 3.103 | PORTSTATS   | 623 |
| 3.104 | PPPPOS  | 625 |
| 3.105 | PPPSATS   | 627 |
| 3.106 | PROFILEINFO   | 629 |
| 3.107 | PSRDOP  | 631 |
| 3.108 | PSRDOP2   | 633 |
| 3.109 | PSRPOS  | 634 |
| 3.110 | PSRSATS   | 636 |
| 3.111 | PSRVEL  | 638 |
| 3.112 | PSRXYZ  | 640 |
| 3.113 | QZSSALMANAC   | 643 |
| 3.114 | QZSSEPHEMERIS   | 645 |
| 3.115 | QZSSIONUTC  | 648 |
| 3.116 | QZSSRAWALMANAC  | 650 |
| 3.117 | QZSSRAWCNAVMESSAGE  | 652 |
| 3.118 | QZSSRAWEPHEM  | 653 |
| 3.119 | QZSSRAWSUBFRAME   | 654 |
| 3.120 | RAIMSTATUS  | 655 |
| 3.121 | RANGE   | 658 |
| 3.122 | RANGECMP  | 667 |
| 3.123 | RANGECMP2   | 672 |
| 3.124 | RANGECMP4   | 679 |
| 3.125 | RANGEGPSL1  | 692 |
| 3.126 | RAWALM  | 694 |
| 3.127 | RAWCNAVFRAME  | 696 |
| 3.128 | RAWEPHEM  | 697 |
| 3.129 | RAWGPSSUBFRAME  | 699 |
| 3.130 | RAWGPSWORD  | 701 |
| 3.131 | RAWSBASFRAME  | 702 |
| 3.132 | RAWSBASFRAME2   | 704 |

---

|         |                              |     |
|---------|------------------------------|-----|
| 3.133   | REFSTATION                   | 706 |
| 3.134   | REFSTATIONINFO               | 708 |
| 3.135   | ROVERPOS                     | 710 |
| 3.136   | RTCMV3 Standard Logs         | 712 |
| 3.136.1 | Legacy Observable Messages   | 712 |
| 3.136.2 | MSM Observable Messages      | 713 |
| 3.136.3 | Station and Antenna Messages | 714 |
| 3.136.4 | Ephemeris Messages           | 715 |
| 3.137   | RTKASSISTSTATUS              | 717 |
| 3.138   | RTKDOP                       | 719 |
| 3.139   | RTKDOP2                      | 721 |
| 3.140   | RTKPOS                       | 722 |
| 3.141   | RTKSATS                      | 725 |
| 3.142   | RTKVEL                       | 727 |
| 3.143   | RTKXYZ                       | 729 |
| 3.144   | RXCONFIG                     | 732 |
| 3.145   | RXSTATUS                     | 734 |
| 3.146   | RXSTATUSEVENT                | 749 |
| 3.147   | SAFEMODESTATUS               | 751 |
| 3.148   | SATVIS2                      | 754 |
| 3.149   | SATXYZ2                      | 757 |
| 3.150   | SBAS0                        | 760 |
| 3.151   | SBAS1                        | 761 |
| 3.152   | SBAS2                        | 762 |
| 3.153   | SBAS3                        | 765 |
| 3.154   | SBAS4                        | 767 |
| 3.155   | SBAS5                        | 769 |
| 3.156   | SBAS6                        | 771 |
| 3.157   | SBAS7                        | 774 |
| 3.158   | SBAS9                        | 777 |
| 3.159   | SBAS10                       | 779 |
| 3.160   | SBAS12                       | 781 |
| 3.161   | SBAS17                       | 783 |
| 3.162   | SBAS18                       | 785 |
| 3.163   | SBAS24                       | 787 |
| 3.164   | SBAS25                       | 790 |
| 3.165   | SBAS26                       | 794 |
| 3.166   | SBAS27                       | 796 |
| 3.167   | SBAS32                       | 798 |
| 3.168   | SBAS33                       | 801 |
| 3.169   | SBAS34                       | 803 |
| 3.170   | SBAS35                       | 805 |
| 3.171   | SBAS45                       | 807 |
| 3.172   | SBASALMANAC                  | 809 |
| 3.173   | SOFTLOADSTATUS               | 811 |
| 3.174   | SOURCETABLE                  | 814 |
| 3.175   | TERRASTARINFO                | 817 |
| 3.176   | TERRASTARSTATUS              | 820 |
| 3.177   | TIME                         | 822 |
| 3.178   | TIMESYNC                     | 825 |

|       |                          |     |
|-------|--------------------------|-----|
| 3.179 | TRACKSTAT .....          | 826 |
| 3.180 | TRANSFERPORTSTATUS ..... | 828 |
| 3.181 | UPTIME .....             | 830 |
| 3.182 | VALIDMODELS .....        | 831 |
| 3.183 | VERIPOSINFO .....        | 833 |
| 3.184 | VERIPOSSTATUS .....      | 835 |
| 3.185 | VERSION .....            | 836 |
| 3.186 | WIFIAPSETTINGS .....     | 839 |

## Chapter 4 SPAN Commands

|      |                            |     |
|------|----------------------------|-----|
| 4.1  | ALIGNMENTMODE .....        | 842 |
| 4.2  | ASYNCHINSLOGGING .....     | 844 |
| 4.3  | CONNECTIMU .....           | 845 |
| 4.4  | EXTERNALPVAS .....         | 847 |
| 4.5  | HEAVEFILTER .....          | 851 |
| 4.6  | INPUTGIMBALANGLE .....     | 852 |
| 4.7  | INSALIGNCONFIG .....       | 854 |
| 4.8  | INSCALIBRATE .....         | 857 |
| 4.9  | INSCOMMAND .....           | 860 |
| 4.10 | INSSEED .....              | 861 |
| 4.11 | INSTHRESHOLDS .....        | 863 |
| 4.12 | INSZUPT .....              | 864 |
| 4.13 | RELINSAUTOMATION .....     | 865 |
| 4.14 | RELINSCONFIG .....         | 867 |
| 4.15 | SETALIGNMENTVEL .....      | 869 |
| 4.16 | SETHEAWEWINDOW .....       | 870 |
| 4.17 | SETIMUPORTPROTOCOL .....   | 871 |
| 4.18 | SETIMUSPECS .....          | 872 |
| 4.19 | SETINITAZIMUTH .....       | 874 |
| 4.20 | SETINSPROFILE .....        | 875 |
| 4.21 | SETINSROTATION .....       | 877 |
| 4.22 | SETINSTRANSFORMATION ..... | 880 |
| 4.23 | SETINSUPDATE .....         | 883 |
| 4.24 | SETMAXALIGNMENTTIME .....  | 884 |
| 4.25 | SETRELINSOUTPUTFRAME ..... | 885 |
| 4.26 | SETUPSENSOR .....          | 887 |
| 4.27 | SETWHEELPARAMETERS .....   | 889 |
| 4.28 | TAGNEXTMARK .....          | 890 |
| 4.29 | TIMEDEVENTPULSE .....      | 891 |
| 4.30 | WHEELVELOCITY .....        | 893 |

## Chapter 5 SPAN Logs

|     |                                  |     |
|-----|----------------------------------|-----|
| 5.1 | Logs with INS or GNSS Data ..... | 896 |
| 5.2 | BESTGNSSPOS .....                | 897 |
| 5.3 | BESTGNSSVEL .....                | 900 |
| 5.4 | CORRIMUDATA .....                | 902 |
| 5.5 | CORRIMUDATAS .....               | 904 |
| 5.6 | DELAYEDHEAVE .....               | 905 |
| 5.7 | GIMBALLEDPVA .....               | 906 |
| 5.8 | HEAVE .....                      | 908 |

---

|      |  |      |
|------|--|------|
| 5.9  | IMURATECORRIMUS .....  | 909  |
| 5.10 | IMURATEPVA .....   | 911  |
| 5.11 | IMURATEPVAS .....  | 913  |
| 5.12 | INSATT .....   | 915  |
| 5.13 | INSATTQS .....   | 918  |
| 5.14 | INSATTS .....  | 920  |
| 5.15 | INSATTX .....  | 921  |
| 5.16 | INSCALSTATUS .....   | 926  |
| 5.17 | INSCONFIG .....  | 928  |
| 5.18 | INSPOS .....   | 932  |
| 5.19 | INSPOSS .....  | 933  |
| 5.20 | INSPOSX .....  | 934  |
| 5.21 | INSPVA .....   | 936  |
| 5.22 | INSPVAS .....  | 938  |
| 5.23 | INSPVAX .....  | 940  |
| 5.24 | INSSEEDSTATUS .....  | 943  |
| 5.25 | INSSPD .....   | 945  |
| 5.26 | INSSPDS .....  | 947  |
| 5.27 | INSSTDEV .....   | 949  |
| 5.28 | INSSTDEVS .....  | 951  |
| 5.29 | INSUPDATESTATUS .....  | 953  |
| 5.30 | INSVEL .....   | 957  |
| 5.31 | INSVELS .....  | 958  |
| 5.32 | INSVELX .....  | 959  |
| 5.33 | MARK1PVA, MARK2PVA, MARK3PVA and MARK4PVA .....                            | 961  |
| 5.34 | PASHR .....  | 963  |
| 5.35 | RAWIMU .....   | 965  |
| 5.36 | RAWIMUS .....  | 986  |
| 5.37 | RAWIMUSX .....   | 991  |
| 5.38 | RAWIMUX .....  | 995  |
| 5.39 | RELINSPVA .....  | 999  |
| 5.40 | SYNCHEAVE .....  | 1002 |
| 5.41 | SYNCRELINSPVA .....  | 1003 |
| 5.42 | TAGGEDMARK1PVA, TAGGEDMARK2PVA, TAGGEDMARK3PVA and<br>TAGGEDMARK4PVA ..... | 1006 |
| 5.43 | TIMEDWHEELDATA .....   | 1008 |
| 5.44 | TSS1 .....   | 1010 |
| 5.45 | VARIABLELEVERARM .....   | 1012 |
| 5.46 | WHEELSIZE .....  | 1013 |

## Chapter 6 Responses

### APPENDIX A Example of Bit Parsing a RANGECMP4 Log

|       |   |      |
|-------|---|------|
| A.1   | Reference Log Decoding .....  | 1024 |
| A.1.1 | Reference Header .....  | 1025 |
| A.1.2 | Reference Satellite and Signal Block: GPS .....                       | 1025 |
| A.1.3 | Reference Measurement Block Header: GPS .....                         | 1026 |
| A.1.4 | Reference Measurement Block: GPS .....                                | 1027 |
| A.1.5 | Reference Primary Signal Measurement Block: GPS PRN 10 – L1CA .....   | 1028 |
| A.1.6 | Reference Secondary Signals Measurement Block: GPS PRN 10 – L2Y ..... | 1030 |
| A.1.7 | Reference Third Signals Measurement Block: GPS PRN 10 – L5Q .....     | 1032 |

---

|        |   |      |
|--------|---|------|
| A.1.8  | Reference Satellite and Signal Block: GLONASS .....                     | 1034 |
| A.1.9  | Reference Measurement Block Header: GLONASS PRN 38 .....                | 1036 |
| A.1.10 | Reference Primary Signal Measurement Block: GLONASS PRN 38 – L1CA ..    | 1037 |
| A.2    | Differential Log Decoding .....   | 1039 |
| A.2.1  | Differential Header .....   | 1039 |
| A.2.2  | Differential Satellite and Signal Block .....                           | 1040 |
| A.2.3  | Differential Measurement Block Header .....                             | 1041 |
| A.2.4  | Differential Measurement Block .....                                    | 1042 |
| A.2.5  | Differential Primary Signal Measurement Block GPS PRN 10 – L1CA .....   | 1043 |
| A.2.6  | Differential Secondary Signals Measurement Block GPS PRN 10 – L2Y ..... | 1045 |
| A.2.7  | Differential Third Signals Measurement Block GPS PRN 10 – L5Q .....     | 1047 |

# Figures

|   |     |
|---|-----|
| Figure 1: Byte Arrangements .....                                 | 26  |
| Figure 2: 1PPS Alignment .....                                    | 55  |
| Figure 3: ADJUST1PPS Connections .....                            | 58  |
| Figure 4: Pulse Width and 1PPS Coherency .....                    | 168 |
| Figure 5: Illustration of Magnetic Variation and Correction ..... | 226 |
| Figure 6: TTL Pulse Polarity .....                                | 228 |
| Figure 7: Moving Base Station 'Daisy Chain' Effect .....          | 235 |
| Figure 8: Using the SEND Command .....                            | 323 |
| Figure 9: Illustration of SETNAV Parameters .....                 | 341 |
| Figure 10: Illustration of Undulation .....                       | 371 |
| Figure 11: The WGS84 ECEF Coordinate System .....                 | 437 |
| Figure 12: Navigation Parameters .....                            | 597 |
| Figure 13: Pass Through Log Data .....                            | 612 |
| Figure 14: Channel Tracking Example .....                         | 662 |

# Tables

|   |     |
|---|-----|
| Table 1: Field Type .....   | 25  |
| Table 2: ASCII Message Header Structure .....                             | 28  |
| Table 3: Binary Message Header Structure .....                            | 30  |
| Table 4: Detailed Port Identifier .....                                   | 31  |
| Table 5: Available Port Types .....                                       | 41  |
| Table 6: Short ASCII Message Header Structure .....                       | 42  |
| Table 7: Short Binary Message Header Structure .....                      | 42  |
| Table 8: Binary Message Response Structure .....                          | 44  |
| Table 9: Binary Message Sequence .....                                    | 45  |
| Table 10: PRN Numbers for Commands and Logs .....                         | 46  |
| Table 11: GPS Reference Time Status .....                                 | 47  |
| Table 12: COM Port Signals Available for 1PPS .....                       | 55  |
| Table 13: ADJUST1PPS Mode .....   | 60  |
| Table 14: Channel State .....   | 68  |
| Table 15: Channel System .....  | 70  |
| Table 16: L-Band Assignment Option .....                                  | 73  |
| Table 17: AUTH Command State .....  | 75  |
| Table 18: Frequency Type .....  | 80  |
| Table 19: Antenna Type .....  | 83  |
| Table 20: Radome Type .....   | 91  |
| Table 21: Velocity Types .....  | 95  |
| Table 22: CAN Port Speed .....  | 96  |
| Table 23: CAN Protocol .....  | 100 |
| Table 24: Tx, DTR and RTS Availability .....                              | 110 |
| Table 25: GNSS Signal Default and Configurability .....                   | 111 |
| Table 26: Signal Type (DATADECODESIGNAL) .....                            | 112 |
| Table 27: Reference Ellipsoid Constants .....                             | 115 |
| Table 28: Datum Transformation Parameters .....                           | 116 |
| Table 29: Signal Type .....   | 124 |
| Table 30: User Dynamics .....   | 128 |
| Table 31: Communications Port Identifiers .....                           | 130 |
| Table 32: Clock Type .....  | 146 |
| Table 33: Pre-Defined Values for Oscillators .....                        | 146 |
| Table 34: FIX Parameters .....  | 159 |
| Table 35: Fix Types .....   | 160 |
| Table 36: GLONASS L2 Code Type .....                                      | 163 |
| Table 37: Signals Tracked – Channel Configuration and L2type Option ..... | 164 |
| Table 38: GPS L2 Code Type .....  | 165 |

---

|  |     |
|--|-----|
| Table 39: Signals Tracked – Channel Configuration and L2type Option .....            | 166 |
| Table 40: FRESET Target .....  | 171 |
| Table 41: Serial Port Interface Modes .....  | 192 |
| Table 42: RF Path Selection .....  | 202 |
| Table 43: Frequency Bands .....  | 205 |
| Table 44: Mode .....   | 205 |
| Table 45: Programmable Filter ID .....   | 207 |
| Table 46: Programmable Filter Mode .....   | 207 |
| Table 47: Data Sources for PSD Samples .....   | 209 |
| Table 48: Frequency Types .....  | 210 |
| Table 49: FFT Sizes .....  | 211 |
| Table 50: NMEA Talkers .....   | 242 |
| Table 51: Profile Option .....   | 274 |
| Table 52: DGPS Type .....  | 276 |
| Table 53: Response Modes .....   | 283 |
| Table 54: RAIM Mode Types .....  | 285 |
| Table 55: Network RTK Mode .....   | 300 |
| Table 56: System Types .....   | 315 |
| Table 57: SBAS Time Out Mode .....   | 318 |
| Table 58: COM Port Identifiers .....   | 327 |
| Table 59: Parity .....   | 327 |
| Table 60: Handshaking .....  | 327 |
| Table 61: Ports Supporting RS-422 .....  | 329 |
| Table 62: Selection Type .....   | 336 |
| Table 63: Ionospheric Correction Models .....  | 339 |
| Table 64: System Used for Timing .....   | 345 |
| Table 65: Available Set Up Commands .....  | 352 |
| Table 66: STEADYLINE Mode .....  | 357 |
| Table 67: TRACKSV Command Condition .....  | 363 |
| Table 68: User Accuracy Level Supplemental Position Types and NMEA Equivalents ..... | 366 |
| Table 69: UTM Zone Commands .....  | 386 |
| Table 70: Log Type Triggers .....  | 391 |
| Table 71: Position Averaging Status .....  | 405 |
| Table 72: Data Source .....  | 415 |
| Table 73: Solution Status .....  | 419 |
| Table 74: Position or Velocity Type .....  | 420 |
| Table 75: GPS and GLONASS Signal-Used Mask .....                                     | 422 |
| Table 76: Galileo and BeiDou Signal-Used Mask .....                                  | 423 |
| Table 77: Extended Solution Status .....   | 423 |
| Table 78: Supplemental Position Types and NMEA Equivalents .....                     | 424 |



---

|  |     |
|--|-----|
| Table 79: Observation Statuses .....   | 426 |
| Table 80: BESTSATS GPS Signal Mask .....   | 427 |
| Table 81: BESTSATS GLONASS Signal Mask .....   | 428 |
| Table 82: BESTSATS Galileo Signal Mask .....   | 428 |
| Table 83: BESTSATS BeiDou Signal Mask .....  | 428 |
| Table 84: Definitions Analogous to the BIH Defined Conventional Terrestrial System (CTS), or BTS, 1984.0. .... | 437 |
| Table 85: CHANCONFIGLIST Signal Type .....   | 441 |
| Table 86: Clock Model Status .....   | 446 |
| Table 87: Clock Source .....   | 448 |
| Table 88: Steering State .....   | 449 |
| Table 89: File Type .....  | 454 |
| Table 90: Mass Storage Device .....  | 456 |
| Table 91: File Status .....  | 456 |
| Table 92: Mass Storage Status .....  | 460 |
| Table 93: File Transfer Status .....   | 462 |
| Table 94: Kp UTC Leap Second Descriptions .....  | 482 |
| Table 95: GLONASS Ephemeris Flags Coding .....   | 486 |
| Table 96: P1 Flag Range Values .....   | 486 |
| Table 97: GPS Quality Indicators .....   | 499 |
| Table 98: Position Precision of NMEA Logs .....  | 503 |
| Table 99: NMEA Positioning System Mode Indicator .....   | 516 |
| Table 100: URA Variance .....  | 522 |
| Table 101: Solution Source .....   | 528 |
| Table 102: Satellite System .....  | 532 |
| Table 103: HWMONITOR Status Table .....  | 535 |
| Table 104: DDC Filter Type .....   | 548 |
| Table 105: ITFILTable Status Word .....  | 548 |
| Table 106: Filter Switches .....   | 549 |
| Table 107: Spectral Analysis Status Word .....   | 553 |
| Table 108: Node Status .....   | 556 |
| Table 109: L-Band Signal Tracking Status .....   | 562 |
| Table 110: Feature Status .....  | 585 |
| Table 111: Feature .....   | 585 |
| Table 112: GNSS Time Scales .....  | 596 |
| Table 113: Navigation Data Type .....  | 599 |
| Table 114: Oceanix Subscription Type .....   | 606 |
| Table 115: Oceanix Subscription Details Mask .....   | 606 |
| Table 116: Oceanix Region Restriction .....  | 606 |
| Table 117: Decoder Data Synchronization State .....  | 607 |
| Table 118: Region Restriction Status .....   | 608 |

---

|  |     |
|--|-----|
| Table 119: Position Type .....   | 626 |
| Table 120: Status Word .....   | 630 |
| Table 121: Integrity Status .....  | 656 |
| Table 122: Protection Level Status .....                                     | 656 |
| Table 123: Channel Tracking Status .....                                     | 662 |
| Table 124: Tracking State .....  | 664 |
| Table 125: Correlator Type .....   | 664 |
| Table 126: RINEX Mappings .....  | 665 |
| Table 127: Range Record Format (RANGECMP only) .....                         | 668 |
| Table 128: StdDev-PSR Values .....   | 670 |
| Table 129: Satellite Block of the Range Record Format (RANGECMP2 only) ..... | 673 |
| Table 130: Signal Block of the Range Record Format (RANGECMP2 only) .....    | 674 |
| Table 131: Std Dev PSR Scaling .....   | 675 |
| Table 132: Std Dev ADR Scaling .....   | 676 |
| Table 133: L1/E1/B1 Scaling .....  | 677 |
| Table 134: Signal Type (only in RANGECMP2) .....                             | 678 |
| Table 135: Header .....  | 681 |
| Table 136: Satellite and Signal Block .....                                  | 682 |
| Table 137: Measurement Block Header .....                                    | 683 |
| Table 138: Primary Reference Signal Measurement Block .....                  | 684 |
| Table 139: Secondary Reference Signals Measurement Block .....               | 685 |
| Table 140: Primary Differential Signal Measurement Block .....               | 686 |
| Table 141: Secondary Differential Signals Measurement Block .....            | 687 |
| Table 142: Signal BitMask .....  | 688 |
| Table 143: Lock Time .....   | 689 |
| Table 144: ADR Std Dev .....   | 690 |
| Table 145: Pseudorange Std Dev .....   | 691 |
| Table 146: Base Station Status .....   | 707 |
| Table 147: Station Type .....  | 707 |
| Table 148: Legacy Observable Messages .....                                  | 712 |
| Table 149: MSM Type Descriptions .....                                       | 713 |
| Table 150: MSM Log Names .....   | 713 |
| Table 151: MSM Message IDs .....   | 714 |
| Table 152: Station and Antenna Messages .....                                | 715 |
| Table 153: Ephemeris Messages .....  | 715 |
| Table 154: Receiver Error .....  | 737 |
| Table 155: Receiver Status .....   | 739 |
| Table 156: Version Bits .....  | 741 |
| Table 157: Auxiliary 1 Status .....  | 741 |
| Table 158: Auxiliary 2 Status .....  | 743 |

---

|  |     |
|--|-----|
| Table 159: Auxiliary 3 Status .....                  | 745 |
| Table 160: Antenna Gain State .....                  | 746 |
| Table 161: Auxiliary 4 Status .....                  | 747 |
| Table 162: Status Word .....                         | 750 |
| Table 163: Event Type .....                          | 750 |
| Table 164: Safe Mode States .....                    | 752 |
| Table 165: Evaluation of UDREI .....                 | 764 |
| Table 166: Evaluation of UDREI .....                 | 799 |
| Table 167: SBAS Subsystem Types .....                | 810 |
| Table 168: SoftLoad Status Type .....                | 811 |
| Table 169: TerraStar Subscription Type .....         | 818 |
| Table 170: TerraStar Subscription Details Mask ..... | 818 |
| Table 171: TerraStar Region Restriction .....        | 819 |
| Table 172: Decoder Data Synchronization State .....  | 821 |
| Table 173: TerraStar Local Area Status .....         | 821 |
| Table 174: TerraStar Geogating Status .....          | 821 |
| Table 175: USB Detection Type .....                  | 828 |
| Table 176: USB Mode .....                            | 829 |
| Table 177: Veripos Operating Mode .....              | 833 |
| Table 178: Veripos Subscription Details Mask .....   | 834 |
| Table 179: Decoder Data Synchronization State .....  | 835 |
| Table 180: Component Types .....                     | 837 |
| Table 181: VERSION Log Field Formats .....           | 838 |
| Table 182: IMU Type .....                            | 846 |
| Table 183: EXTERNALPVAS Updates Mask .....           | 849 |
| Table 184: EXTERNALPVAS Options Mask .....           | 850 |
| Table 185: COM Ports .....                           | 868 |
| Table 186: Rotational Offset Types .....             | 878 |
| Table 187: Translation Offset Types .....            | 881 |
| Table 188: Translation Input Frame .....             | 882 |
| Table 189: Inertial Solution Status .....            | 916 |
| Table 190: Extended Solution Status .....            | 922 |
| Table 191: Alignment Indication .....                | 924 |
| Table 192: NVM Seed Indication .....                 | 925 |
| Table 193: Offset Type .....                         | 927 |
| Table 194: Source Status .....                       | 927 |
| Table 195: Injection Status .....                    | 944 |
| Table 196: Heading Update Values .....               | 954 |
| Table 197: INS Update Status .....                   | 955 |
| Table 198: iIMU-FSAS IMU Status .....                | 969 |

|  |      |
|--|------|
| Table 199: HG1700 IMU Status .....                   | 970  |
| Table 200: LN200 IMU Status .....                    | 971  |
| Table 201: ISA-100C IMU Status .....                 | 973  |
| Table 202: IMU-CPT IMU Status .....                  | 974  |
| Table 203: IMU-KVH1750 IMU Status .....              | 976  |
| Table 204: HG1900 and HG1930 IMU Status .....        | 977  |
| Table 205: ADIS16488 and IMU-IGM-A1 IMU Status ..... | 979  |
| Table 206: STIM300 and IMU-IGM-S1 IMU Status .....   | 981  |
| Table 207: $\mu$ IMU IMU Status .....                | 982  |
| Table 208: G320N IMU Status .....                    | 984  |
| Table 209: Raw IMU Scale Factors .....               | 990  |
| Table 210: Response Messages .....                   | 1014 |

# Customer Support

## NovAtel Knowledge Base

If you have a technical issue, visit the NovAtel Support page at [www.novatel.com/support](http://www.novatel.com/support). Through the *Support* page, you can contact Customer Support, find papers and tutorials or download current manuals and the latest firmware.

## Before Contacting Customer Support

Before you contact NovAtel Customer Support about a software problem, perform the following steps:



If logging data over an RS-232 serial cable, ensure that the configured baud rate can support the data bandwidth (see **SERIALCONFIG** command). NovAtel recommends a minimum suggested baud rate of 115200 bps.

1. Log the following data to a file on your computer for 15 minutes:

```
RXSTATUSB onchanged
RAWEPHEMB onchanged
GLORAWEPHEMB onchanged
BESTPOSB ontime 1
RANGEB ontime 1
RXCONFIGA once
VERSIONA once
```

For SPAN systems, add the following logs to the above list in the file created on your computer:

```
RAWIMUSXB onnew
INSUPDATESTATUSB onnew
INSPVAXB ontime 1
INSCONFIGA once
```

2. Send the data file to NovAtel Customer Support: [support@novatel.com](mailto:support@novatel.com)
3. You can also issue a **FRESET** command to the receiver to clear any unknown settings.



The **FRESET** command will erase all user settings. You should know your configuration (by requesting the RXCONFIGA log) and be able to reconfigure the receiver before you send the **FRESET** command.

If you are having a hardware problem, send a list of the troubleshooting steps taken and the results.

## Contact Information

Log a support request with NovAtel Customer Support using one of the following methods:

### Log a Case and Search Knowledge:

Website: [www.novatel.com/support](http://www.novatel.com/support)

**Log a Case, Search Knowledge and View Your Case History:** (login access required)

Web Portal: <https://novatelsupport.force.com/community/login>

**E-mail:**

[support@novatel.com](mailto:support@novatel.com)

**Telephone:**

U.S. and Canada: 1-800-NOVATEL (1-800-668-2835)

International: +1-403-295-4900

# Foreword

This manual describes each command and log the OEM7 family of receivers are capable of accepting or generating. Sufficient detail is provided so you can understand the purpose, syntax and structure of each command or log. You will also be able to communicate with the receiver, enabling you to effectively use and write custom interfacing software for specific applications.

## Related Documents and Information

OEM7 products include the following:

- Satellite Based Augmentation System (SBAS) signal functionality
- Support for all current and upcoming GNSS constellations
- L-Band capability including TerraStar licensed based corrections
- National Marine Electronics Association (NMEA) standards, a protocol used by GNSS receivers to transmit data
- Differential Global Positioning System (DGPS)
- Real-Time Kinematic (RTK)

For more information on these components, refer the Support page on our website at [www.novatel.com/support](http://www.novatel.com/support). For introductory information on GNSS technology, refer to our *An Introduction to GNSS* book found at [www.novatel.com/an-introduction-to-gnss/](http://www.novatel.com/an-introduction-to-gnss/)

This manual does not address any of the receiver hardware attributes or installation information. Consult the [OEM7 Installation and Operation User Manual](#) for information about these topics. Furthermore, should you encounter any functional, operational or interfacing difficulties with the receiver, refer to the NovAtel web site for warranty and support information.

## Prerequisites

As this reference manual is focused on the OEM7 family commands and logging protocol, it is necessary to ensure the receiver has been properly installed and powered up according to the instructions outlined in the companion [OEM7 Installation and Operation User Manual](#) for OEM7 receivers.

## Logs and Commands Defaults and Structure

- The factory defaults for commands and logs are shown after the syntax but before the example in the command or log description.
- The letter H in the Binary Byte or Binary Offset columns of the commands and logs tables represents the header length for that command or log, see *Binary* on page 29.
- The number following 0x is a hexadecimal number.
- Default values shown in command tables indicate the assumed values when optional parameters have been omitted. Default values do not imply the factory default settings.
- Parameters surrounded by [ and ] are optional in a command or are required for only some instances of the command depending on the values of other parameters.
- Text displayed between < and > indicates the entry of a keystroke in the case of the command or an automatic entry in the case of carriage return <CR> and line feed <LF> in data output.
- In tables where no values are given they are assumed to be reserved for future use.
- Status words in ASCII logs are output as hexadecimal numbers and must be converted to binary format (and in some cases then also to decimal) to parse the fields because they are not

fixed in 4-bits boundary. For an example of this type of conversion, see the RANGE log, *Table 123: Channel Tracking Status* on page 662.

- Conversions and their binary or decimal results are always read from right to left. For a complete list of hexadecimal, binary and decimal equivalents, refer to the [Unit Conversion](#) information available on our website at [www.novatel.com/support/search/](http://www.novatel.com/support/search/).
- ASCII log examples may be split over several lines for readability. In reality, only a single [CR][LF] pair is transmitted at the end of an ASCII log.

You can download the most up-to-date version of this manual along with any addenda from the [Support](#) section of the NovAtel website.



# Chapter 1 Messages

The receiver handles incoming and outgoing NovAtel data in three different message formats: Abbreviated ASCII, ASCII and Binary. This allows for a great deal of versatility in the way the OEM7 family of receivers can be used. All NovAtel commands and logs can be entered, transmitted, output or received in any of the three formats. The receiver also supports RTCMV3, NOVATELX and NMEA format messaging.

When entering an ASCII or abbreviated ASCII command to request an output log, the message type is indicated by the character appended to the end of the message name. 'A' indicates the message is ASCII and 'B' indicates binary. No character means the message is Abbreviated ASCII. When issuing binary commands, the output message type is dependent on the bit format in the message's binary header (refer to *Binary* on page 29).

*Table 1: Field Type* below, describes the field types used in the description of messages.

**Table 1: Field Type**

| Type   | Binary Size (bytes) | Description  |
|--------|---------------------|--|
| Char   | 1                   | The <b>char</b> type is an 8-bit integer in the range -128 to +127. This integer value may be the ASCII code corresponding to the specified character. In ASCII or Abbreviated ASCII this comes out as an actual character |
| UChar  | 1                   | The <b>uchar</b> type is an 8-bit unsigned integer. Values are in the range from +0 to +255. In ASCII or Abbreviated ASCII this comes out as a number  |
| Short  | 2                   | The <b>short</b> type is 16-bit integer in the range -32768 to +32767  |
| UShort | 2                   | The same as short except it is not signed. Values are in the range from +0 to +65535   |
| Long   | 4                   | The <b>long</b> type is 32-bit integer in the range -2147483648 to +2147483647   |
| ULong  | 4                   | The same as long except it is not signed. Values are in the range from +0 to +4294967295   |
| Double | 8                   | The <b>double</b> type contains 64-bits: 1 for sign, 11 for the exponent and 52 for the mantissa. Its range is $\pm 1.7E308$ with at least 15 digits of precision. This is IEEE 754  |
| Float  | 4                   | The <b>float</b> type contains 32-bits: 1 for the sign, 8 for the exponent and 23 for the mantissa. Its range is $\pm 3.4E38$ with at least 7 digits of precision. This is IEEE 754  |
| Enum   | 4                   | A 4-byte enumerated type beginning at zero (an unsigned long). In binary, the enumerated value is output. In ASCII or Abbreviated ASCII, the enumeration label is spelled out  |

| Type      | Binary Size (bytes) | Description   |
|-----------|---------------------|---|
| GPSec     | 4                   | This type has two separate formats dependent on whether you requested a binary or an ASCII format output. For binary, the output is in milliseconds and is a <b>long</b> type. For ASCII, the output is in seconds and is a <b>float</b> type                       |
| Hex       | n                   | <b>Hex</b> is a packed, fixed length (n) array of bytes in binary but in ASCII or Abbreviated ASCII is converted into 2 character hexadecimal pairs   |
| Hex ULong | 4                   | An unsigned, 32-bit integer in hexadecimal format. Values are in the range from +0 to +4294967295   |
| String    | n                   | <b>String</b> is a variable length array of bytes that is null-terminated in the binary case and additional bytes of padding are added to maintain 4-byte alignment. The maximum byte length for each String field is shown in the row in the log or command tables |

Figure 1: Byte Arrangements

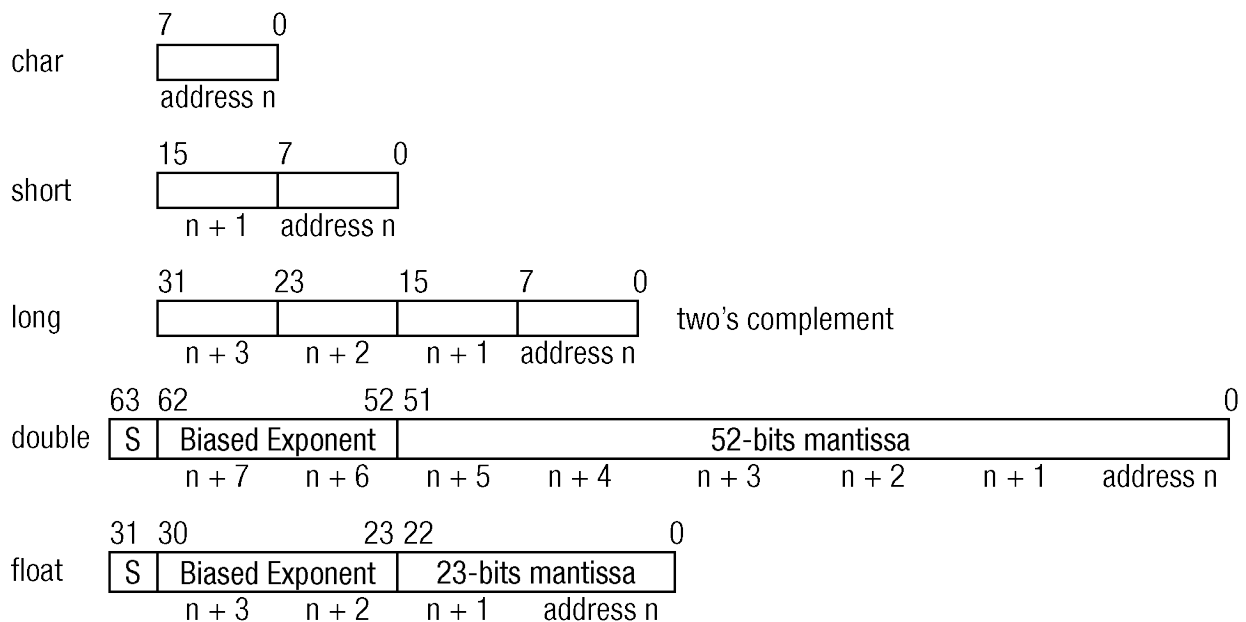

*Byte Arrangements* above shows the arrangement of bytes, within each field type, when used by IBM PC computers. All data sent to or from the OEM7 family of receivers, however, is read least significant bit (LSB) first, opposite to what is shown in *Byte Arrangements* above. Data is then stored in the receiver LSB first. For example, in char type data, the LSB is bit 0 and the most significant bit (MSB) is bit 7. See *Table 123: Channel Tracking Status* on page 662 for a more detailed example.

## 1.1 ASCII

ASCII messages are readable by both the user and a computer. The structures of all ASCII messages follow the general conventions as noted here:

1. The lead code identifier for each record is '#'.
2. Each log or command is of variable length depending on amount of data and formats.
3. All data fields are delimited by a comma ',' with two exceptions:
  - The first exception is the last header field which is followed by a ';' to denote the start of the data message.
  - The second exception is the last data field, which is followed by a \* to indicate end of message data.
4. Each log ends with a hexadecimal number preceded by an asterisk and followed by a line termination using the carriage return and line feed characters.

For example:

\*1234ABCD[CR][LF]. This value is a 32-bit CRC of all bytes in the log, excluding the '#' identifier and the asterisk preceding the eight CRC digits.

See *32-Bit CRC* on page 49 for the algorithm used to generate the CRC.

5. The receiver only accepts the following ASCII characters.
  - characters between space (ASCII value 32) and '~' (ASCII value 126) inclusive,
  - vertical tab (ASCII value 9)
  - line feed (ASCII value 10)
  - horizontal tab (ASCII value 11)
  - carriage return (ASCII value 13)

Other values are discarded and can lead to unexpected results.

6. An ASCII string is one field and is surrounded by double quotation marks.

For example:

"ASCII string". If separators are surrounded by quotation marks then the string is still one field and the separator will be ignored (example, "xxx,xxx" is one field). Double quotation marks within a string are not allowed.

7. If the receiver detects an error parsing an input message, it returns an error response message. See *Responses* on page 1014 for a list of response messages from the receiver.

### Message Structure:

header; data field..., data field..., data field... \*xxxxxxxx [CR][LF]

The ASCII message header structure is described in *Table 2: ASCII Message Header Structure* on the next page.

**Table 2: ASCII Message Header Structure**

| Field | Field Name           | Field Type | Description  | Ignored on Input |
|-------|----------------------|------------|--|------------------|
| 1     | Sync                 | Char       | Sync character. The ASCII message is always preceded by a single '#' symbol  | N                |
| 2     | Message              | Char       | The ASCII name of the log or command   | N                |
| 3     | Port                 | Char       | The name of the port from which the log was generated. The string is made up of the port name followed by an _x where x is a number from 1 to 31 denoting the virtual address of the port. If no virtual address is indicated, it is assumed to be address 0 | Y                |
| 4     | Sequence #           | Long       | Used for multiple related logs. It is a number that counts down from N-1 to 0, where 0 means it is the last one of the set. Most logs only come out one at a time in which case this number is 0   | N                |
| 5     | % Idle Time          | Float      | The minimum percentage of time the processor is idle, calculated once per second   | Y                |
| 6     | Time Status          | Enum       | The value indicates the quality of the GPS reference time (see <i>Table 11: GPS Reference Time Status</i> on page 47)  | Y                |
| 7     | Week                 | Ulong      | GPS reference week number  | Y                |
| 8     | Seconds              | GPSec      | Seconds from the beginning of the GPS reference week; accurate to the millisecond level  | Y                |
| 9     | Receiver Status      | Ulong      | An eight digit hexadecimal number representing the status of various hardware and software components of the receiver (see <i>Table 155: Receiver Status</i> on page 739)  | Y                |
| 10    | Reserved             | Ulong      | Reserved for internal use.   | Y                |
| 11    | Receiver S/W Version | Ulong      | A value (0 - 65535) representing the receiver software build number  | Y                |
| 12    | ;                    | Char       | The character indicates the end of the header  | N                |

**Example Log:**

```
#RAWEPHEMA, COM1, 0, 35.0, SATTIME, 1364, 496230.000, 02100000, 97b7, 2310; 30, 1
364,
496800, 8b0550a1892755100275e6a09382232523a9dc04ee6f794a0000090394ee,
8b0550a189aa6ff925386228f97eabf9c8047e34a70ec5a10e486e794a7a,
8b0550a18a2effc2f80061c2fffc267cd09f1d5034d3537affa28b6ff0eb*7a22f279
```

## 1.2 Abbreviated ASCII

This message format is designed to make entering and viewing commands and logs simple. The data is represented as simple ASCII characters, separated by spaces or commas and arranged in an easy to understand format. There is no 32-bit CRC for error detection because it is meant for viewing by the user.

### Example Command:

```
log com1 loglist
```

### Resultant Log:

```
<LOGLIST COM1 0 69.0 FINE 0 0.000 00240000 206d 0
< 4
< COM1 RXSTATUSEVENTA ONNEW 0.000000 0.000000 NOHOLD
< COM2 RXSTATUSEVENTA ONNEW 0.000000 0.000000 NOHOLD
< COM3 RXSTATUSEVENTA ONNEW 0.000000 0.000000 NOHOLD
< COM1 LOGLIST ONCE 0.000000 0.000000 NOHOLD
```

The array of 4 entries are offset from the left hand side and start with '<'.

## 1.3 Binary

Binary messages are strictly machine readable format. They are ideal for applications where the amount of data transmitted is fairly high. Due to the inherent compactness of binary as opposed to ASCII data, messages are much smaller. The smaller message size allows a larger amount of data to be transmitted and received by the receiver's communication ports. The structure of all binary messages follows the general conventions as noted here:

1. Basic format of:
  - *Header*: 3 Sync bytes plus 25-bytes of header information. The header length is variable as fields may be appended in the future. Always check the header length.
  - *CRC*: 4 bytes
  - *Data*: variable
2. The 3 Sync bytes will always be:

| Byte   | Hex | Decimal |
|--------|-----|---------|
| First  | AA  | 170     |
| Second | 44  | 68      |
| Third  | 12  | 18      |

3. The CRC is a 32-bit CRC (see *32-Bit CRC* on page 49 for the CRC algorithm) performed on all data including the header.
4. The header is in the format shown in *Table 3: Binary Message Header Structure* on the next page.

**Table 3: Binary Message Header Structure**

| Field | Field Name     | Field Type | Description   | Binary Bytes | Binary Offset | Ignored on Input |
|-------|----------------|------------|---|--------------|---------------|------------------|
| 1     | Sync           | Char       | Hexadecimal 0xAA  | 1            | 0             | N                |
| 2     | Sync           | Char       | Hexadecimal 0x44  | 1            | 1             | N                |
| 3     | Sync           | Char       | Hexadecimal 0x12  | 1            | 2             | N                |
| 4     | Header Lgth    | Uchar      | Length of the header  | 1            | 3             | N                |
| 5     | Message ID     | Ushort     | This is the Message ID number of the log (see the command or log descriptions for the Message ID values of individual commands or logs)   | 2            | 4             | N                |
| 6     | Message Type   | Char       | Bits 0-4 = Measurement source <sup>1</sup><br>Bits 5-6 = Format<br>00 = Binary<br>01 = ASCII<br>10 = Abbreviated ASCII, NMEA<br>11 = Reserved<br><br>Bit 7 = Response bit (see <i>Message Responses</i> on page 42)<br>0 = Original Message<br>1 = Response Message | 1            | 6             | N                |
| 7     | Port Address   | Uchar      | See <i>Table 4: Detailed Port Identifier</i> on the next page (decimal values $\geq 32$ may be used) (lower 8-bits only) <sup>2</sup>   | 1            | 7             | N <sup>3</sup>   |
| 8     | Message Length | Ushort     | The length in bytes of the body of the message, not including the header nor the CRC  | 2            | 8             | N                |

<sup>1</sup>Bits 0-4 are used to indicate the measurement source. For dual antenna receivers, if bit 0 is set, the log is from the secondary antenna.

<sup>2</sup>The 8-bit size means you will only see 0xA0 to 0xBF when the top bits are dropped from a port value greater than 8-bits. For example, ASCII port USB1 will be seen as 0xA0 in the binary output.

<sup>3</sup>Recommended value is THISPORT (binary 192).

| Field | Field Name           | Field Type | Description   | Binary Bytes   | Binary Offset | Ignored on Input |
|-------|----------------------|------------|---|----------------|---------------|------------------|
| 9     | Sequence             | Ushort     | Used for multiple related logs. It is a number that counts down from N-1 to 0 where N is the number of related logs and 0 means it is the last one of the set. Most logs only come out one at a time in which case this number is 0 | 2              | 10            | N                |
| 10    | Idle Time            | Uchar      | Time the processor is idle, calculated once per second. Take the time (0 - 200) and divide by two to give the percentage of time (0 - 100%)   | 1              | 12            | Y                |
| 11    | Time Status          | Enum       | Indicates the quality of the GPS reference time (see <i>Table 11: GPS Reference Time Status</i> on page 47).  | 1 <sup>1</sup> | 13            | N <sup>2</sup>   |
| 12    | Week                 | Ushort     | GPS reference week number   | 2              | 14            | N                |
| 13    | ms                   | GPSec      | Milliseconds from the beginning of the GPS reference week   | 4              | 16            | N                |
| 14    | Receiver Status      | Ulong      | 32-bits representing the status of various hardware and software components of the receiver (see <i>Table 155: Receiver Status</i> on page 739)   | 4              | 20            | Y                |
| 15    | Reserved             | Ushort     | Reserved for internal use   | 2              | 24            | Y                |
| 16    | Receiver S/W Version | Ushort     | A value (0 - 65535) representing the receiver software build number   | 2              | 26            | Y                |

**Table 4: Detailed Port Identifier**

| ASCII Port Name | Hex Port Value | Decimal Port Value | Description                |
|-----------------|----------------|--------------------|----------------------------|
| NO_PORTS        | 0              | 0                  | No ports specified         |
| COM1_ALL        | 1              | 1                  | All virtual ports for COM1 |

<sup>1</sup>This ENUM is not 4-bytes long but, as indicated in the table, is only 1-byte.

<sup>2</sup>Fields 12 and 13 (Week and ms) are ignored if Field 11 (Time Status) is invalid. In this case, the current receiver time is used. The recommended values for the three time fields are 0, 0, 0.

<sup>3</sup>Decimal port values 0 through 16 are only available to the **UNLOGALL** command (see page 378) and cannot be used in the **UNLOG** command (see page 376) or in the binary message header (see *Table 3: Binary Message Header Structure* on the previous page).

| ASCII Port Name | Hex Port Value | Decimal Port Value | Description                            |
|-----------------|----------------|--------------------|--|
| COM2_ALL        | 2              | 2                  | All virtual ports for COM2             |
| COM3_ALL        | 3              | 3                  | All virtual ports for COM3             |
| THISPORT_ALL    | 6              | 6                  | All virtual ports for the current port |
| FILE_ALL        | 7              | 7                  | All virtual ports for logging to file  |
| ALL_PORTS       | 8              | 8                  | All virtual ports for all ports        |
| XCOM1_ALL       | 9              | 9                  | All virtual ports for XCOM1            |
| XCOM2_ALL       | a              | 10                 | All virtual ports for XCOM2            |
| USB1_ALL        | d              | 13                 | All virtual ports for USB1             |
| USB2_ALL        | e              | 14                 | All virtual ports for USB2             |
| USB3_ALL        | f              | 15                 | All virtual ports for USB3             |
| AUX_ALL         | 10             | 16                 | All virtual ports for the AUX          |
| XCOM3_ALL       | 11             | 17                 | All virtual XCOM3                      |
| COM4_ALL        | 13             | 19                 | All virtual ports for COM4             |
| ETH1_ALL        | 14             | 20                 | All virtual ports for ETH1             |
| IMU_ALL         | 15             | 21                 | All virtual ports for IMU              |
| ICOM1_ALL       | 17             | 23                 | All virtual ports for ICOM1            |
| ICOM2_ALL       | 18             | 24                 | All virtual ports for ICOM2            |
| ICOM3_ALL       | 19             | 25                 | All virtual ports for ICOM3            |
| NCOM1_ALL       | 1a             | 26                 | All virtual ports for NCOM1            |
| NCOM2_ALL       | 1b             | 27                 | All virtual ports for NCOM2            |
| NCOM3_ALL       | 1c             | 28                 | All virtual ports for NCOM3            |
| ICOM4_ALL       | 1d             | 29                 | All virtual ports for ICOM4            |
| WCOM1_ALL       | 1e             | 30                 | All virtual ports for WCOM1            |
| COM1            | 20             | 32                 | COM1, virtual port 0                   |

<sup>1</sup>Decimal port values 0 through 16 are only available to the **UNLOGALL** command (see page 378) and cannot be used in the **UNLOG** command (see page 376) or in the binary message header (see *Table 3: Binary Message Header Structure* on the previous page).



| ASCII Port Name | Hex Port Value | Decimal Port Value | Description                         |
|-----------------|----------------|--------------------|-------------------------------------|
| COM1_1          | 21             | 33                 | COM1, virtual port 1                |
| ...             |                |                    |                                     |
| COM1_31         | 3f             | 63                 | COM1, virtual port 31               |
| COM2            | 40             | 64                 | COM2, virtual port 0                |
| COM2_1          | 41             | 65                 | COM1, virtual port 1                |
| ...             |                |                    |                                     |
| COM2_31         | 5f             | 95                 | COM2, virtual port 31               |
| COM3            | 60             | 96                 | COM3, virtual port 0                |
| COM3_1          | 61             | 97                 | COM3, virtual port 1                |
| ...             |                |                    |                                     |
| COM3_31         | 7f             | 127                | COM3, virtual port 31               |
| SPECIAL         | a0             | 160                | Unknown port, virtual port 0        |
| SPECIAL_1       | a1             | 161                | Unknown port, virtual port1         |
| ...             |                |                    |                                     |
| SPECIAL_31      | bf             | 191                | Unknown port, virtual port 31       |
| THISPORT        | c0             | 192                | Current COM port, virtual port 0    |
| THISPORT_1      | c1             | 193                | Current COM port, virtual port 1    |
| ...             |                |                    |                                     |
| THISPORT_31     | df             | 223                | Current COM port, virtual port 31   |
| FILE            | e0             | 224                | Virtual port 0 for logging to file  |
| FILE_1          | e1             | 225                | Virtual port 1 for logging to file  |
| ...             |                |                    |                                     |
| FILE_31         | ff             | 255                | Virtual port 31 for logging to file |
| XCOM1           | 1a0            | 416                | XCOM1, virtual port 0               |

<sup>1</sup>Decimal port values 0 through 16 are only available to the **UNLOGALL** command (see page 378) and cannot be used in the **UNLOG** command (see page 376) or in the binary message header (see *Table 3: Binary Message Header Structure* on the previous page).

| ASCII Port Name | Hex Port Value | Decimal Port Value | Description                 |
|-----------------|----------------|--------------------|-----------------------------|
| XCOM1_1         | 1a1            | 417                | XCOM1, virtual port 1       |
| ...             |                |                    |                             |
| XCOM1_31        | 1bf            | 447                | XCOM1, virtual port 31      |
| XCOM2           | 2a0            | 672                | XCOM2, virtual port 0       |
| XCOM2_1         | 2a1            | 673                | XCOM2, virtual port 1       |
| ...             |                |                    |                             |
| XCOM2_31        | 2bf            | 703                | XCOM2, virtual port 31      |
| USB1            | 5a0            | 1440               | USB1, virtual port 0        |
| USB1_1          | 5a1            | 1441               | USB1, virtual port 1        |
| ...             |                |                    |                             |
| USB1_31         | 5bf            | 1471               | USB1, virtual port 31       |
| USB2            | 6a0            | 1696               | USB2, virtual port 0        |
| USB2_1          | 6a1            | 1967               | USB2, virtual port 1        |
| ...             |                |                    |                             |
| USB2_31         | 6bf            | 1727               | USB2, virtual port 31       |
| USB3            | 7a0            | 1952               | USB3, virtual port 0        |
| USB3_1          | 7a1            | 1953               | USB3, virtual port 1        |
| ...             |                |                    |                             |
| USB3_31         | 7bf            | 1983               | USB port 3, virtual port 31 |
| AUX             | 8a0            | 2208               | AUX port, virtual port 0    |
| AUX_1           | 8a1            | 2209               | AUX port, virtual port 1    |
| ...             |                |                    |                             |
| AUX_31          | 8bf            | 2239               | AUX port, virtual port 31   |
| XCOM3           | 9a0            | 2464               | XCOM3, virtual port 0       |

<sup>1</sup>Decimal port values 0 through 16 are only available to the **UNLOGALL** command (see page 378) and cannot be used in the **UNLOG** command (see page 376) or in the binary message header (see *Table 3: Binary Message Header Structure* on the previous page).

| ASCII Port Name | Hex Port Value | Decimal Port Value | Description            |
|-----------------|----------------|--------------------|------------------------|
| XCOM3_1         | 9a1            | 2465               | XCOM3, virtual port 1  |
| ...             |                |                    |                        |
| XCOM3_31        | 9bf            | 2495               | XCOM3, virtual port 31 |
| COM4            | ba0            | 2976               | COM4, virtual port 0   |
| COM4_1          | ba1            | 2977               | COM4, virtual port 1   |
| ...             |                |                    |                        |
| COM4_31         | bbf            | 3007               | COM4, virtual port 31  |
| ETH1            | ca0            | 3232               | ETH1, virtual port 0   |
| ETH1_1          | ca1            | 3233               | ETH1, virtual port 1   |
| ...             |                |                    |                        |
| ETH1_31         | cbf            | 3263               | ETH1, virtual port 31  |
| IMU             | da0            | 3488               | IMU, virtual port 0    |
| IMU_1           | da1            | 3489               | IMU, virtual port 1    |
| ...             |                |                    |                        |
| IMU_31          | dbf            | 3519               | IMU, virtual port 31   |
| ICOM1           | fa0            | 4000               | ICOM1, virtual port 0  |
| ICOM1_1         | fa1            | 4001               | ICOM1, virtual port 1  |
| ...             |                |                    |                        |
| ICOM1_31        | fbf            | 4031               | ICOM1, virtual port 31 |
| ICOM2           | 10a0           | 4256               | ICOM2, virtual port 0  |
| ICOM2_1         | 10a1           | 4257               | ICOM2, virtual port 1  |
| ...             |                |                    |                        |
| ICOM2_31        | 10bf           | 4287               | ICOM2, virtual port 31 |
| ICOM3           | 11a0           | 4512               | ICOM3, virtual port 0  |

<sup>1</sup>Decimal port values 0 through 16 are only available to the **UNLOGALL** command (see page 378) and cannot be used in the **UNLOG** command (see page 376) or in the binary message header (see *Table 3: Binary Message Header Structure* on the previous page).

| ASCII Port Name | Hex Port Value | Decimal Port Value | Description                |
|-----------------|----------------|--------------------|----------------------------|
| ICOM3_1         | 11a1           | 4513               | ICOM3, virtual port 1      |
| ...             |                |                    |                            |
| ICOM3_31        | 11bf           | 4543               | ICOM3, virtual port 31     |
| NCOM1           | 12a0           | 4768               | NCOM1, virtual port 0      |
| NCOM1_1         | 12a1           | 4769               | NCOM1, virtual port 1      |
| ...             |                |                    |                            |
| NCOM1_31        | 12bf           | 4799               | NCOM1, virtual port 31     |
| NCOM2           | 13a0           | 5024               | NCOM2, virtual port 0      |
| NCOM2_1         | 13a1           | 5025               | NCOM2, virtual port 1      |
| ...             |                |                    |                            |
| NCOM2_31        | 13bf           | 5055               | NCOM2, virtual port 31     |
| NCOM3           | 14a0           | 5280               | NCOM3, virtual port 0      |
| NCOM3_1         | 14a1           | 5281               | NCOM3, virtual port 1      |
| ...             |                |                    |                            |
| NCOM3_31        | 14bf           | 5311               | NCOM3, virtual port 31     |
| ICOM4           | 15a0           | 5536               | ICOM4, virtual port 0      |
| ICOM4_1         | 15a1           | 5537               | ICOM4, virtual port 1      |
| ...             |                |                    |                            |
| ICOM4_31        | 15bf           | 5567               | ICOM4, virtual port 31     |
| WCOM1           | 16a0           | 5792               | WCOM1, virtual port 0      |
| WCOM1_1         | 16a1           | 5793               | WCOM1, virtual port 1      |
| ...             |                |                    |                            |
| WCOM1_31        | 16bf           | 5823               | WCOM1, virtual port 31     |
| COM5_ALL        | 16c0           | 5824               | All virtual ports for COM5 |

<sup>1</sup>Decimal port values 0 through 16 are only available to the **UNLOGALL** command (see page 378) and cannot be used in the **UNLOG** command (see page 376) or in the binary message header (see *Table 3: Binary Message Header Structure* on the previous page).

| ASCII Port Name | Hex Port Value | Decimal Port Value | Description                                |
|-----------------|----------------|--------------------|--|
| COM6_ALL        | 16c1           | 5825               | All virtual ports for COM6                 |
| BT1_ALL         | 16c2           | 5826               | All virtual ports for the Bluetooth device |
| COM7_ALL        | 16c3           | 5827               | All virtual ports for COM7                 |
| COM8_ALL        | 16c4           | 5828               | All virtual ports for COM8                 |
| COM9_ALL        | 16c5           | 5829               | All virtual ports for COM9                 |
| COM10_ALL       | 16c6           | 5830               | All virtual ports for COM10                |
| CCOM1_ALL       | 16c7           | 5831               | All virtual ports for CCOM1                |
| CCOM2_ALL       | 16c8           | 5832               | All virtual ports for CCOM2                |
| CCOM3_ALL       | 16c9           | 5833               | All virtual ports for CCOM3                |
| CCOM4_ALL       | 16ca           | 5834               | All virtual ports for CCOM4                |
| CCOM5_ALL       | 16cb           | 5835               | All virtual ports for CCOM5                |
| CCOM6_ALL       | 16cc           | 5836               | All virtual ports for CCOM6                |
| ICOM5_ALL       | 16cf           | 5839               | All virtual ports for ICOM5                |
| ICOM6_ALL       | 16d0           | 5840               | All virtual ports for ICOM6                |
| ICOM7_ALL       | 16d1           | 5841               | All virtual ports for ICOM7                |
| SCOM1_ALL       | 16d2           | 5842               | All virtual ports for SCOM1                |
| SCOM2_ALL       | 16d3           | 5843               | All virtual ports for SCOM2                |
| SCOM3_ALL       | 16d4           | 5844               | All virtual ports for SCOM3                |
| SCOM4_ALL       | 16d5           | 5845               | All virtual ports for SCOM4                |
| COM5            | 17a0           | 6048               | COM5, virtual port 0                       |
| COM5_1          | 17a1           | 6049               | COM5, virtual port 1                       |
| ...             |                |                    |  |
| COM5_31         | 17bf           | 6079               | COM5, virtual port 31                      |
| COM6            | 18a0           | 6304               | COM6, virtual port 0                       |

<sup>1</sup>Decimal port values 0 through 16 are only available to the **UNLOGALL** command (see page 378) and cannot be used in the **UNLOG** command (see page 376) or in the binary message header (see *Table 3: Binary Message Header Structure* on the previous page).

| ASCII Port Name | Hex Port Value | Decimal Port Value | Description                       |
|-----------------|----------------|--------------------|-----------------------------------|
| COM6_1          | 18a1           | 6305               | COM6, virtual port 1              |
| ...             |                |                    |                                   |
| COM6_31         | 18bf           | 6335               | COM6, virtual port 31             |
| BT1             | 19a0           | 6560               | Bluetooth device, virtual port 0  |
| BT1_1           | 19a1           | 6561               | Bluetooth device, virtual port 1  |
| ...             |                |                    |                                   |
| BT1_31          | 19bf           | 6591               | Bluetooth device, virtual port 31 |
| COM7            | 1aa0           | 6816               | COM7, virtual port 0              |
| COM7_1          | 1aa1           | 6817               | COM7, virtual port 1              |
| ...             |                |                    |                                   |
| COM7_31         | 1abf           | 6847               | COM7, virtual port 31             |
| COM8            | 1ba0           | 7072               | COM8, virtual port 0              |
| COM8_1          | 1ba1           | 7073               | COM8, virtual port 1              |
| ...             |                |                    |                                   |
| COM8_31         | 1bbf           | 7103               | COM8, virtual port 31             |
| COM9            | 1ca0           | 7328               | COM9, virtual port 0              |
| COM9_1          | 1ca1           | 7329               | COM9, virtual port 1              |
| ...             |                |                    |                                   |
| COM9_31         | 1cbf           | 7359               | COM9, virtual port 31             |
| COM10           | 1da0           | 7584               | COM10, virtual port 0             |
| COM10_1         | 1da1           | 7585               | COM10, virtual port 1             |
| ...             |                |                    |                                   |
| COM10_31        | 1dbf           | 7615               | COM10, virtual port 31            |
| CCOM1           | 1ea0           | 7840               | CAN COM1, virtual port 0          |

<sup>1</sup>Decimal port values 0 through 16 are only available to the **UNLOGALL** command (see page 378) and cannot be used in the **UNLOG** command (see page 376) or in the binary message header (see *Table 3: Binary Message Header Structure* on the previous page).

| ASCII Port Name | Hex Port Value | Decimal Port Value | Description               |
|-----------------|----------------|--------------------|---------------------------|
| CCOM1_1         | 1ea1           | 7841               | CAN COM1, virtual port 1  |
| ...             |                |                    |                           |
| CCOM1_31        | 1ebf           | 7871               | CAN COM1, virtual port 31 |
| CCOM2           | 1fa0           | 8096               | CAN COM2, virtual port 0  |
| CCOM2_1         | 1fa1           | 8097               | CAN COM2, virtual port 1  |
| ...             |                |                    |                           |
| CCOM2_31        | 1fbf           | 8127               | CAN COM2, virtual port 31 |
| CCOM3           | 20a0           | 8352               | CAN COM3, virtual port 0  |
| CCOM3_1         | 20a1           | 8353               | CAN COM3, virtual port 1  |
| ...             |                |                    |                           |
| CCOM3_31        | 20bf           | 8383               | CAN COM3, virtual port 31 |
| CCOM4           | 21a0           | 8608               | CAN COM4, virtual port 0  |
| CCOM4_1         | 21a1           | 8609               | CAN COM4, virtual port 1  |
| ...             |                |                    |                           |
| CCOM4_31        | 21bf           | 8639               | CAN COM4, virtual port 31 |
| CCOM5           | 22a0           | 8864               | CAN COM5, virtual port 0  |
| CCOM5_1         | 22a1           | 8865               | CAN COM5, virtual port 1  |
| ...             |                |                    |                           |
| CCOM5_31        | 22bf           | 8895               | CAN COM5, virtual port 31 |
| CCOM6           | 23a0           | 9120               | CAN COM6, virtual port 0  |
| CCOM6_1         | 23a1           | 9121               | CAN COM6, virtual port 1  |
| ...             |                |                    |                           |
| CCOM6_31        | 23bf           | 9151               | CAN COM6, virtual port 31 |
| ICOM5           | 26a0           | 9888               | ICOM5, virtual port 0     |

<sup>1</sup>Decimal port values 0 through 16 are only available to the **UNLOGALL** command (see page 378) and cannot be used in the **UNLOG** command (see page 376) or in the binary message header (see *Table 3: Binary Message Header Structure* on the previous page).

| ASCII Port Name | Hex Port Value | Decimal Port Value | Description            |
|-----------------|----------------|--------------------|------------------------|
| ICOM5_1         | 26a1           | 9889               | ICOM5, virtual port 1  |
| ...             |                |                    |                        |
| ICOM5_31        | 26bf           | 9919               | ICOM5, virtual port 31 |
| ICOM6           | 27a0           | 10144              | ICOM6, virtual port 0  |
| ICOM6_1         | 27a1           | 10145              | ICOM6, virtual port 1  |
| ...             |                |                    |                        |
| ICOM6_31        | 27bf           | 10175              | ICOM6, virtual port 31 |
| ICOM7           | 28a0           | 10400              | ICOM7, virtual port 0  |
| ICOM7_1         | 28a1           | 10401              | ICOM7, virtual port 1  |
| ...             |                |                    |                        |
| ICOM7_31        | 28bf           | 10431              | ICOM7, virtual port 31 |
| SCOM1           | 29a0           | 10656              | SCOM1, virtual port 0  |
| SCOM1_1         | 29a1           | 10657              | SCOM1, virtual port 1  |
| ...             |                |                    |                        |
| SCOM1-31        | 29bf           | 10687              | SCOM1, virtual port 31 |
| SCOM2           | 2aa0           | 10912              | SCOM2, virtual port 0  |
| SCOM2_1         | 2aa1           | 10913              | SCOM2, virtual port 1  |
| ...             |                |                    |                        |
| SCOM2_31        | 2abf           | 10943              | SCOM2, virtual port 31 |
| SCOM3           | 2ba0           | 11168              | SCOM3, virtual port 0  |
| SCOM3_1         | 2ba1           | 11169              | SCOM3, virtual port 1  |
| ...             |                |                    |                        |
| SCOM3_31        | 2bbf           | 11199              | SCOM3, virtual port 31 |
| SCOM4           | 2ca0           | 11424              | SCOM4, virtual port 0  |

<sup>1</sup>Decimal port values 0 through 16 are only available to the **UNLOGALL** command (see page 378) and cannot be used in the **UNLOG** command (see page 376) or in the binary message header (see *Table 3: Binary Message Header Structure* on the previous page).



| ASCII Port Name | Hex Port Value | Decimal Port Value | Description            |
|-----------------|----------------|--------------------|------------------------|
| SCOM4_1         | 2ca1           | 11425              | SCOM4, virtual port 1  |
| ...             |                |                    |                        |
| SCOM4_31        | 2cbf           | 11455              | SCOM4, virtual port 31 |



COM1\_ALL, COM2\_ALL, COM3\_ALL, COM4\_ALL, COM5\_ALL, THISPORT\_ALL, FILE\_ALL, ALL\_PORTS, USB1\_ALL, USB2\_ALL, USB3\_ALL, AUX\_ALL, ETH1\_ALL, ICOM1\_ALL, ICOM2\_ALL, ICOM3\_ALL, ICOM4\_ALL, ICOM5\_ALL, ICOM6\_ALL, ICOM7\_ALL, CCOM1\_ALL, CCOM2\_ALL, CCOM3\_ALL, CCOM4\_ALL, CCOM5\_ALL, CCOM6\_ALL, NCOM1\_ALL, NCOM2\_ALL, NCOM3\_ALL, SCOM1\_ALL, SCOM2\_ALL, SCOM3\_ALL, SCOM4\_ALL, WCOM1\_ALL, XCOM1\_ALL, XCOM2\_ALL and XCOM3\_ALL are only valid for the **UNLOGALL** command.



The ports available vary based on the receiver.

Table 5: Available Port Types below provides examples of where each port type might be used.

**Table 5: Available Port Types**

| Port Type | Description              | Example of where it might be used  |
|-----------|--------------------------|--|
| AUX       | Auxiliary "serial" ports | An additional UART serial port available only on certain platforms                                     |
| BTx       | Bluetooth ports          | These ports are used to connect over Bluetooth devices, when the receiver is equipped with a BT device |
| COMx      | Serial Port              | UART serial ports. Used when there is a physical RS-232 or RS-422 connection to the receiver           |
| ICOMx     | Internet ports           | These ports are used when establishing TCP or UDP connections to the receiver over a network           |
| NCOMx     | NTRIP ports              | These ports are used when establishing NTRIP connections to the receiver over a network                |
| SCOMx     | Script ports             | Ports used by the Scripted User Interface (i.e. Lua)   |
| USBx      | USB "serial" ports       | When the receiver is connected to an external host through USB, these ports are available              |

<sup>1</sup>Decimal port values 0 through 16 are only available to the **UNLOGALL** command (see page 378) and cannot be used in the **UNLOG** command (see page 376) or in the binary message header (see Table 3: Binary Message Header Structure on the previous page).

| Port Type | Description     | Example of where it might be used   |
|-----------|-----------------|---|
| WCOMx     | Web Server port | Ports used by Web Server applications, for receivers equipped with a web server |
| XCOMx     | Virtual Port    | A "port" not associated with a physical communications port.                    |

## 1.4 Description of ASCII and Binary Logs with Short Headers

These logs are set up in the same way as normal ASCII or binary logs except a normal ASCII or binary header is replaced with a short header (see *Table 6: Short ASCII Message Header Structure* below and *Table 7: Short Binary Message Header Structure* below).

**Table 6: Short ASCII Message Header Structure**

| Field | Field Name   | Field Type | Description                                      |
|-------|--------------|------------|--|
| 1     | %            | Char       | % symbol   |
| 2     | Message      | Char       | This is the name of the log                      |
| 3     | Week Number  | Ushort     | GNSS week number                                 |
| 4     | Milliseconds | Ulong      | Milliseconds from the beginning of the GNSS week |

**Table 7: Short Binary Message Header Structure**

| Field | Field Name     | Field Type | Description                                      | Binary Bytes | Binary Offset |
|-------|----------------|------------|--|--------------|---------------|
| 1     | Synch          | Char       | Hex 0xAA   | 1            | 0             |
| 2     | Synch          | Char       | Hex 0x44   | 1            | 1             |
| 3     | Synch          | Char       | Hex 0x13   | 1            | 2             |
| 4     | Message Length | Uchar      | Message length, not including header or CRC      | 1            | 3             |
| 5     | Message ID     | Ushort     | Message ID number                                | 2            | 4             |
| 6     | Week Number    | Ushort     | GNSS week number                                 | 2            | 6             |
| 7     | Milliseconds   | Ulong      | Milliseconds from the beginning of the GNSS week | 4            | 8             |

## 1.5 Message Responses

By default, if you input a message you get back a response. If desired, the **INTERFACEMODE** command (see page 189) can be used to disable response messages. The response will be in the exact format you entered the message (that is, binary input = binary response).

### **1.5.1 Abbreviated ASCII Response**

Just the leading '<' followed by the response string, for example: <OK.

### **1.5.2 ASCII Response**

Full header with the message name being identical except ending in an 'R' (for response). The body of the message consists of a 40 character string for the response string. For example:

```
#BESTPOSR,COM1,0,67.0,FINE,1028,422060.400,02000000,a31b,0;"OK" *b867caad
```

### **1.5.3 Binary Response**

Similar to an ASCII response except that it follows the binary protocols, see *Table 8: Binary Message Response Structure* on the next page.

*Table 9: Binary Message Sequence* on page 45 is an example of the sequence for requesting and then receiving BESTPOSB. The example is in hex format. When you enter a hex command, you may need to add a '\x' or '\0x' before each hex pair, depending on your code. For example:

**0xAA0x440x120x1C0x010x000x02** and so on.

**Table 8: Binary Message Response Structure**

|                            | Field                      | Field Name     | Field Type           | Description   | Binary Bytes  | Binary Offset  |    |
|----------------------------|----------------------------|----------------|----------------------|---|---|----------------|----|
| B<br>I<br>N<br>A<br>R<br>Y | 1                          | Sync           | Char                 | Hexadecimal 0xAA  | 1   | 0              |    |
|                            | 2                          | Sync           | Char                 | Hexadecimal 0x44  | 1   | 1              |    |
|                            | 3                          | Sync           | Char                 | Hexadecimal 0x12  | 1   | 2              |    |
|                            | 4                          | Header Lgth    | Uchar                | Length of the header  | 1   | 3              |    |
|                            | 5                          | Message ID     | Ushort               | Message ID number   | 2   | 4              |    |
|                            | 6                          | Message Type   | Char                 | Bit 7 = Response Bit<br>1 = Response Message  | 1   | 6              |    |
|                            | 7                          | Port Address   | Uchar                | See <i>Table 4: Detailed Port Identifier</i> on page 31   | 1   | 7              |    |
|                            | 8                          | Message Length | Ushort               | The length in bytes of the body of the message (not including the CRC)  | 2   | 8              |    |
|                            | H<br>E<br>A<br>D<br>E<br>R | 9              | Sequence             | Ushort  | Normally 0  | 2              | 10 |
|                            |                            | 10             | Idle Time            | Uchar   | Idle time   | 1              | 12 |
|                            |                            | 11             | Time Status          | Enum  | <i>Table 11: GPS Reference Time Status</i> on page 47 | 1 <sup>1</sup> | 13 |
|                            |                            | 12             | Week                 | Ushort  | GPS reference week number                             | 2              | 14 |
|                            |                            | 13             | ms                   | GPSec   | Milliseconds into GPS reference week                  | 4              | 16 |
|                            |                            | 14             | Receiver Status      | Ulong   | <i>Table 155: Receiver Status</i> on page 739         | 4              | 20 |
|                            |                            | 15             | Reserved             | Ushort  | Reserved  | 2              | 24 |
|                            |                            | 16             | Receiver S/W Version | Ushort  | Receiver software build number                        | 2              | 26 |
| I<br>D                     | 17                         | Response ID    | Enum                 | The enumeration value corresponding to the message response ( <i>Table 210: Response Messages</i> on page 1014) | 4   | 28             |    |
| H<br>E<br>X                | 18                         | Response       | Hex                  | String containing the ASCII response in hex coding to match the ID above (for example, 0x4F4B = OK)             | variable  | 32             |    |

<sup>1</sup>This ENUM is not 4-bytes long but as indicated in the table is only 1 byte.

**Table 9: Binary Message Sequence**

| Direction     | Sequence            | Data  |
|---------------|---------------------|---|
| To Receiver   | LOG Command Header  | AA44121C 01000240 20000000 1D1D0000 29160000 00004C00 55525A80  |
|               | LOG Parameters      | 20000000 2A000000 02000000 00000000 0000F03F 00000000 00000000  |
|               | Checksum            | 2304B3F1  |
| From Receiver | LOG Response Header | AA44121C 01008220 06000000 FFB4EE04 605A0513 00004C00 FFFF5A80  |
|               | LOG Response Data   | 01000000 4F4B   |
|               | Checksum            | DA8688EC  |
| From Receiver | BESTPOSB Header     | AA44121C 2A000220 48000000 90B49305 B0ABB912 00000000 4561BC0A  |
|               | BESTPOSB Data       | 00000000 10000000 1B0450B3 F28E4940 16FA6BBE 7C825CC0 0060769F 449F9040 A62A82C1 3D000000 125ACB3F CD9E983F DB664040 00303030 00000000 00000000 0B0B0000 00060003 |
|               | Checksum            | 42DC4C48  |

## 1.6 GLONASS Slot and Frequency Numbers

When a PRN in a log is in the range 38 to 61, then that PRN represents a GLONASS Slot Number where the Slot Number shown is the actual GLONASS Slot Number plus 37.

Similarly, the GLONASS Frequency shown in logs is the actual GLONASS Frequency plus 7.

For example:

```
<RANGE COM1 0 82.0 FINESTEERING 1729 155076.000 02004000 5103 11465
46
31 0 24514687.250 0.064 -128825561.494675 0.010 3877.473 45.0 563.310
18109c04
...
46 5 24097664.754 0.213 -128680178.570435 0.014 -3740.543 40.6 10098.600
08119e44
...
8 0 39844800.076 0.043 -160438471.200694 0.013 -392.547 42.5 12038.660
00349c84
```

where 31 and 8 are GPS satellites and 46 is a GLONASS satellite. Its actual GLONASS Slot Number is 9 and its frequency is -2.

Refer to *PRN Numbers* below for more information about GLONASS PRN numbers. Also, refer to [An Introduction to GNSS](#) available on our website for more information.

### 1.6.1 PRN Numbers

The PRN and SVID ranges for the logs and commands that use them are shown in the following table.

**Table 10: PRN Numbers for Commands and Logs**

| Command/Log        | GPS PRN | SBAS PRN | SBAS QZSS L1-SAIF PRN | GLONASS Slot | Galileo SVID | QZSS PRN | BDS PRN | NavIC PRN |
|--------------------|---------|----------|-----------------------|--------------|--------------|----------|---------|-----------|
| <b>ASSIGN</b>      | 1-32    | 120-158  | 183-192               | 38-61        | 1-36         | 193-202  | 1-30    | 1-7       |
| <b>ASSIGNALL</b>   | 1-32    | 120-158  | 183-192               | 38-61        | 1-36         | 193-202  | 1-30    | 1-7       |
| <b>LOCKOUT</b>     | 1-32    | 120-158  | 183-192               | 38-61        | -            | 193-202  | -       | 1-7       |
| <b>SBASCONTROL</b> | -       | 120-158  | 183-192               | -            | -            | -        | -       | -         |
| <b>TRACKSV</b>     | 1-32    | 120-158  | 183-192               | 38-61        | 1-36         | 193-202  | 1-30    | 1-7       |
| <b>UNLOCKOUT</b>   | 1-32    | 120-158  | 183-192               | 38-61        | -            | 193-202  | -       | 1-7       |
| <b>RANGE</b>       | 1-32    | 120-158  | 183-192               | 38-61        | 1-36         | 193-202  | 1-30    | 1-7       |
| <b>RANGECMP</b>    | 1-32    | 120-158  | 183-192               | 38-61        | 1-36         | 193-202  | 1-30    | 1-7       |
| <b>RANGECMP2</b>   | 1-32    | 120-158  | 183-192               | 1-24         | 1-36         | 193-202  | 1-30    | 1-7       |
| <b>RANGECMP4</b>   | 1-32    | 120-158  | 183-192               | 1-24         | 1-36         | 193-202  | 1-30    | 1-7       |
| <b>RANGEGPSL1</b>  | 1-32    | -        | -                     | -            | -            | -        | -       | -         |
| <b>SATVIS2</b>     | 1-32    | 120-158  | 183-192               | 1-24         | 1-36         | 193-202  | 1-30    | 1-7       |
| <b>TRACKSTAT</b>   | 1-32    | 120-158  | 183-192               | 38-61        | 1-36         | 193-202  | 1-30    | 1-7       |

## 1.7 GPS Reference Time Status

All reported receiver times are subject to a qualifying time status. The status indicates how well a time is known (see *Table 11: GPS Reference Time Status* below).

**Table 11: GPS Reference Time Status**

| GPS Reference Time Status (Decimal) | GPS Reference Time Status (ASCII) | Description  |
|-------------------------------------|-----------------------------------|--|
| 20                                  | UNKNOWN                           | Time validity is unknown   |
| 60                                  | APPROXIMATE                       | Time is set approximately  |
| 80                                  | COARSEADJUSTING                   | Time is approaching coarse precision   |
| 100                                 | COARSE                            | This time is valid to coarse precision   |
| 120                                 | COARSESTEERING                    | Time is coarse set and is being steered  |
| 130                                 | FREEWHEELING                      | Position is lost and the range bias cannot be calculated                                       |
| 140                                 | FINEADJUSTING                     | Time is adjusting to fine precision  |
| 160                                 | FINE                              | Time has fine precision  |
| 170                                 | FINEBACKUPSTEERING                | Time is fine set and is being steered by the backup system                                     |
| 180                                 | FINESTEERING                      | Time is fine set and is being steered  |
| 200                                 | SATTIME                           | Time from satellite. Only used in logs containing satellite data such as ephemeris and almanac |

There are several distinct states the receiver goes through.

When the **CLOCKADJUST** command (see page 101) is enabled:

- UNKNOWN (initial state)
- COARSESTEERING (initial coarse time set)
- FINESTEERING (normal operating state)
- FINEBACKUPSTEERING (when the backup system is used for a time)
- FREEWHEELING (when range bias becomes unknown)

When the **CLOCKADJUST** command (see page 101) is disabled:

- UNKNOWN (initial state)
- COARSE (initial coarse time set)
- FINE (normal operating state)

On startup and before any satellites are tracked, the receiver can not possibly know the current time. As such, the receiver time starts counting at GPS reference week 0 and second 0.0. The time status flag is set to UNKNOWN.

If time is input to the receiver using the **SETAPPROXTIME** command (see page 332), the time status will be APPROXIMATE.

After the first ephemeris is decoded, the receiver time is set to a resolution of  $\pm 10$  milliseconds. This state is qualified by the COARSE or COARSESTEERING time status flag depending on the state of the CLOCKADJUST switch (for more information, refer to the **CLOCKADJUST** command on page 101).

Once a position is known and range biases are being calculated, the internal clock model will begin modeling the range biases also known as the receiver clock offset.

Modeling will continue until the model is a good estimation of the actual receiver clock behavior. At this time, the receiver time will again be adjusted, this time to an accuracy of  $\pm 1$  microsecond. This state is qualified by the FINE time status flag.

The final logical time status flag depends on whether **CLOCKADJUST** is enabled or not. If CLOCKADJUST is disabled, the time status flag will never improve on FINE. The time will only be adjusted again to within  $\pm 1$  microsecond if the range bias gets larger than  $\pm 250$  milliseconds. If CLOCKADJUST is enabled, the time status flag is set to FINESTEERING and the receiver time is continuously updated (steered) to minimize the receiver range bias.

If a solution cannot be computed with the primary satellite system, it will attempt to use a backup system (if available). When the backup system is used and time is computed, the time status is set to FINEBACKUPSTEERING. If the position is lost and the range bias cannot be calculated, the time status is degraded to FREEWHEELING.



See also *Message Time Stamps* below and the **SETTIMEBASE** command on page 344.

## 1.8 Message Time Stamps

All NovAtel format messages generated by the OEM7 family of receivers have a GPS reference time stamp in their header. GPS reference time is referenced to UTC with zero point defined as midnight on the night of January 5, 1980. The time stamp consists of the number of weeks since that zero point and the number of seconds since the last week number change (0 to 604,799). GPS reference time differs from UTC time since leap seconds are occasionally inserted into UTC and GPS reference time is continuous. In addition, a small error (less than 1 microsecond) can exist in synchronization between UTC and GPS reference time. The TIME log reports both GNSS and UTC time and the offset between the two.

The data in synchronous logs (for example, RANGE, BESTPOS, TIME) are based on a periodic measurement of satellite pseudoranges. The time stamp on these logs is the receiver estimate of GPS reference time at the time of the measurement. A synchronous log with trigger ONTIME 1 can be used in conjunction with the 1PPS signal to provide relative accuracy better than 250 ns.

Other log types (asynchronous and polled) are triggered by an external event and the time in the header may not be synchronized to the current GPS reference time. Logs that contain satellite broadcast data (for example, ALMANAC, GPSEPHEM) have the transmit time of their last sub-frame in the header. In the header of differential time matched logs (for example, MATCHEDPOS) is the time of the matched reference and local observation that they are based on. Logs triggered by a mark event (for example, MARKEDPOS, MARKTIME) have the estimated GPS reference time of the mark event in their header. In the header of polled logs (for example, LOGLIST, PORTSTATS, VERSION) is the approximate GPS reference time when their data was



generated. However, when asynchronous logs are triggered ONTIME, the time stamp will represent the time the log was generated and not the time given in the data.

For more information about log types, see *Log Types* on page 391.

## 1.9 Decoding of the GPS Reference Week Number

The GPS reference week number provided in the raw satellite data is the 10 least significant bits (or 8 least significant bits in the case of the almanac data) of the full week number. When the receiver processes the satellite data, the week number is decoded in the context of the current era and therefore is computed as the full week number starting from week 0 or January 6, 1980. Therefore, in all log headers and decoded week number fields, the full week number is given. Only in raw data, such as the *data* field of the **RAWALM** log (see page 694) or the *subframe* field of the **RAWEPHEM** log (see page 697), will the week number remain as the 10 (or 8) least significant bits.

## 1.10 32-Bit CRC

The ASCII and Binary OEM7 family message formats all contain a 32-bit CRC for data verification. This allows the user to ensure the data received (or transmitted) is valid with a high level of certainty. This CRC can be generated using the following C algorithm:

```
#define CRC32_POLYNOMIAL 0xEDB88320L
/* -----
-----
Calculate a CRC value to be used by CRC calculation functions.
-----
--- */
unsigned long CRC32Value(int i)
{
    int j;
    unsigned long ulCRC;
        ulCRC = i;
    for ( j = 8 ; j > 0; j-- )
    {
        if ( ulCRC & 1 )
            ulCRC = ( ulCRC >> 1 ) ^ CRC32_POLYNOMIAL;
        else
            ulCRC >>= 1;
    }
    return ulCRC;
}
/* -----
-----
Calculates the CRC-32 of a block of data all at once
-----
--- */
unsigned long CalculateBlockCRC32(
    unsigned long ulCount, /* Number of bytes in the data block */
    unsigned char *ucBuffer ) /* Data block */
{
    unsigned long ulTemp1;
    unsigned long ulTemp2;
    unsigned long ulCRC = 0;
```

```

while ( ulCount-- != 0 )
{
ulTemp1 = ( ulCRC >> 8 ) & 0x00FFFFFFL;
ulTemp2 = CRC32Value( ((int) ulCRC ^ *ucBuffer++ ) & 0xff );
ulCRC = ulTemp1 ^ ulTemp2;
}
return( ulCRC );
}

```



The NMEA checksum is an XOR of all the bytes (including delimiters such as ',' but excluding the \* and \$) in the message output. It is therefore an 8-bit and not a 32-bit checksum.

Not all logs may be available. Every effort is made to ensure examples are correct, however, a checksum may be created for promptness in publication. In this case it will appear as '9999'.

### Example:

BESTPOSA and BESTPOSB from an OEM7 family receiver.

### ASCII:

```

#BESTPOSA,COM1,0,78.0,FINESTEERING,1427,325298.000,00000000,6145,2748;
SOL_COMPUTED,SINGLE,51.11678928753,-114.03886216575,1064.3470,-16.2708,
WGS84,2.3434,1.3043,4.7300,"",0.000,0.000,7,7,0,0,0,06,0,03*9c9a92bb

```

### BINARY:

```

0xAA, 0x44, 0x12, 0x1C 0x2A, 0x00, 0x02, 0x20, 0x48, 0x00, 0x00, 0x00, 0x90,
0xB4, 0x93, 0x05, 0xB0, 0xAB, 0xB9, 0x12, 0x00, 0x00, 0x00, 0x00, 0x45,
0x61, 0xBC, 0x0A, 0x00, 0x00, 0x00, 0x00, 0x10, 0x00, 0x00, 0x00, 0x1B,
0x04, 0x50, 0xB3, 0xF2, 0x8E, 0x49, 0x40, 0x16, 0xFA, 0x6B, 0xBE, 0x7C,
0x82, 0x5C, 0xC0, 0x00, 0x60, 0x76, 0x9F, 0x44, 0x9F, 0x90, 0x40, 0xA6,
0x2A, 0x82, 0xC1, 0x3D, 0x00, 0x00, 0x00, 0x12, 0x5A, 0xCB, 0x3F, 0xCD,
0x9E, 0x98, 0x3F, 0xDB, 0x66, 0x40, 0x40, 0x00, 0x30, 0x30, 0x30, 0x00,
0x00, 0x00, 0x00, 0x00, 0x00, 0x00, 0x00, 0x0B, 0x0B, 0x00, 0x00, 0x00,
0x06, 0x00, 0x03, 0x42, 0xdc, 0x4c,0x48

```

Below is a demonstration of how to generate the CRC from both ASCII and BINARY messages using the function described above.



When you pass the data into the code that follows, exclude the checksum shown in ***bold italics*** above.

### ASCII:

```

#include <iostream.h>
#include <string.h>
void main()
{
char *i =

```

```
"BESTPOSA,COM2,0,77.5,FINESTEERING,1285,160578.000,00000020,5941,1164;-
SOL_COMPUTED,SINGLE,51.11640941570,-114.03830951024,1062.6963,-
16.2712,WGS84,1.6890,1.2564,2.7826,\"\",0.000,0.000,10,10,0,0,0,0,0";
unsigned long iLen = strlen(i);
unsigned long CRC = CalculateBlockCRC32(iLen, (unsigned char*)i);
cout << hex << CRC <<endl;
}
```

**BINARY:**

```
#include <iostream.h>
#include <string.h>
int main()
{
unsigned char buffer[] = {0xAA, 0x44, 0x12, 0x1C, 0x2A, 0x00, 0x02,
0x20, 0x48, 0x00, 0x00, 0x00, 0x90, 0xB4, 0x93, 0x05, 0xB0, 0xAB, 0xB9,
0x12, 0x00, 0x00, 0x00, 0x00, 0x45, 0x61, 0xBC, 0x0A, 0x00, 0x00, 0x00,
0x00, 0x10, 0x00, 0x00, 0x00, 0x1B, 0x04, 0x50, 0xB3, 0xF2, 0x8E, 0x49,
0x40, 0x16, 0xFA, 0x6B, 0xBE, 0x7C, 0x82, 0x5C, 0xC0, 0x00, 0x60, 0x76,
0x9F, 0x44, 0x9F, 0x90, 0x40, 0xA6, 0x2A, 0x82, 0xC1, 0x3D, 0x00, 0x00,
0x00, 0x12, 0x5A, 0xCB, 0x3F, 0xCD, 0x9E, 0x98, 0x3F, 0xDB, 0x66, 0x40,
0x40, 0x00, 0x30, 0x30, 0x30, 0x00, 0x00, 0x00, 0x00, 0x00, 0x00, 0x00,
0x00, 0x0B, 0x0B, 0x00, 0x00, 0x00, 0x06, 0x00, 0x03};
unsigned long crc = CalculateBlockCRC32(sizeof(buffer)buffer);
cout << hex << crc <<endl;
//Please note that this hex needs to be reversed due to Big Endian
order where the most significant value in the sequence is stored first
(at the lowest storage address). For example, the two bytes required
for the hex number 4F52 is stored as 524F.
}
```

## Chapter 2 Core Commands

The commands used to configure the OEM7 receiver and GNSS functions are described in the following sections.

For information about SPAN specific commands, refer to the *SPAN Commands* on page 841.

### 2.1 Command Formats

The receiver accepts commands in 3 formats as described in *Messages* on page 25:

- Abbreviated ASCII
- ASCII
- Binary

Abbreviated ASCII is the easiest to use for your input. The other two formats include a CRC for error checking and are intended for use when interfacing with other electronic equipment.

The following are examples of the same command in each format:

#### Abbreviated ASCII Example:

```
LOG COM1 BESTPOSB ONTIME 1[CR]
```

#### ASCII Example:

```
#LOGA,THISPORT,0,0,UNKNOWN,0,0.0,0,0,0;COM1,BESTPOSB,ONTIME,1.000000,0.000000,NOHOLD*ec9ce601[CR]
```

#### Binary Example:

```
AA44121C 010000C0 20000000 00FF0000 00000000 00000000 00000000 20000000  
2A000000 02000000 00000000 0000F03F 00000000 00000000 00000000 34D32DC1
```

#### 2.1.1 Optional Parameters

Many commands have nested optional parameters where an optional parameter requires the optional parameter before it to be present. This is noted in the Abbreviated ASCII Syntax as:

```
Command [OPT_1 [OPT_2 [OPT_3]]]
```

In this syntax example, OPT\_1 and OPT\_2 must be provided if you want to provide a value for OPT\_3. These leading two options are required even if you want to use the defaults for OPT\_1 and OPT\_2.

### 2.2 Command Settings

There are several ways to determine the current command settings of the receiver:

1. Request an **RXCONFIG** log (see page 732). This log provides a listing of all commands issued to the receiver and their parameter settings. It also provides the most complete information.
2. For some specific commands, logs are available to indicate all their parameter settings. The **LOGLIST** log (see page 564) shows all active logs in the receiver beginning with the **LOG**

command (see page 216).

3. Request a log of the specific command of interest to show the parameters last entered for that command. The format of the log produced is exactly the same as the format of the specific command with updated header information.



Requesting a log for specific command is useful for most commands. For commands repeated with different parameters (for example, **SERIALCONFIG** and **LOG**), only the most recent set of parameters used is shown. To view all sets of parameters, try method 1 or 2 above.

#### Abbreviated ASCII Example:

```
log fix
<FIX COM1 0 45.0 FINE 1114 151898.288 00200000 dbfd 33123
<      NONE -10000.000000000000 -10000.000000000000 -10000.0000
```

## 2.3 Factory Defaults

When the receiver is first powered up or after a **FRESET** command (see page 170), all commands revert to their factory default settings. When you use a command without specifying its optional parameters, it may have a different command default than the factory default. The **SAVECONFIG** command (see page 311) can be used to save these defaults. Use the **RXCONFIG** log (see page 732) to reference any default command and log settings.

Ensure that all windows, other than the Console window, are closed in NovAtel's Connect user interface application before you issue the **SAVECONFIG** command (see page 311).



**FRESET STANDARD** causes all previously stored user configurations saved to non-volatile memory to be erased (including Saved Config, Saved Almanac, Saved Ephemeris and L-Band-related data, excluding subscription information).

## 2.4 Command Reference

When a command is used without specifying its optional parameters, it may have a different command default than the factory default. Factory default settings for individual commands are stated in the following commands, organized alphabetically by command name.

## 2.5 ADJUST1PPS

### *Adjusts the receiver clock*

**Platform: OEM719, OEM729, OEM7500, OEM7700, OEM7720, PwrPak7, HxGN PIM7500**

Use this command to adjust the receiver clock or as part of the procedure to transfer time between receivers. The number of pulses per second (PPS) is always set to 1 Hz with this command. It is typically used when the receiver is not adjusting its own clock and is using an external reference frequency.

To disable the automatic clock adjustment, refer to the **CLOCKADJUST** command on page 101. To configure the receiver to use an external reference oscillator, see the **EXTERNALCLOCK** command on page 144.

The **ADJUST1PPS** command can be used to:

- Manually shift the phase of the clock
- Adjust the phase of the clock so the output 1PPS signal matches an external signal
- Set the receiver clock close to that of another GNSS receiver
- Set the receiver clock exactly in phase of another GNSS receiver



1. The resolution of the clock synchronization is 20 ns.
2. To adjust the 1PPS output, when the receiver's internal clock is being used and the **CLOCKADJUST** command is enabled, use the **CLOCKOFFSET** command on page 106.
3. If the 1PPS rate is adjusted, the new rate does not start until the next second begins.

*Figure 2: 1PPS Alignment* on the next page shows the 1PPS alignment between a Fine and a Warm Clock receiver. See also the **TIMESYNC** log on page 825 and the *Transfer Time Between Receivers* section in the [OEM7 Installation and Operation User Manual](#).

**Figure 2: 1PPS Alignment**

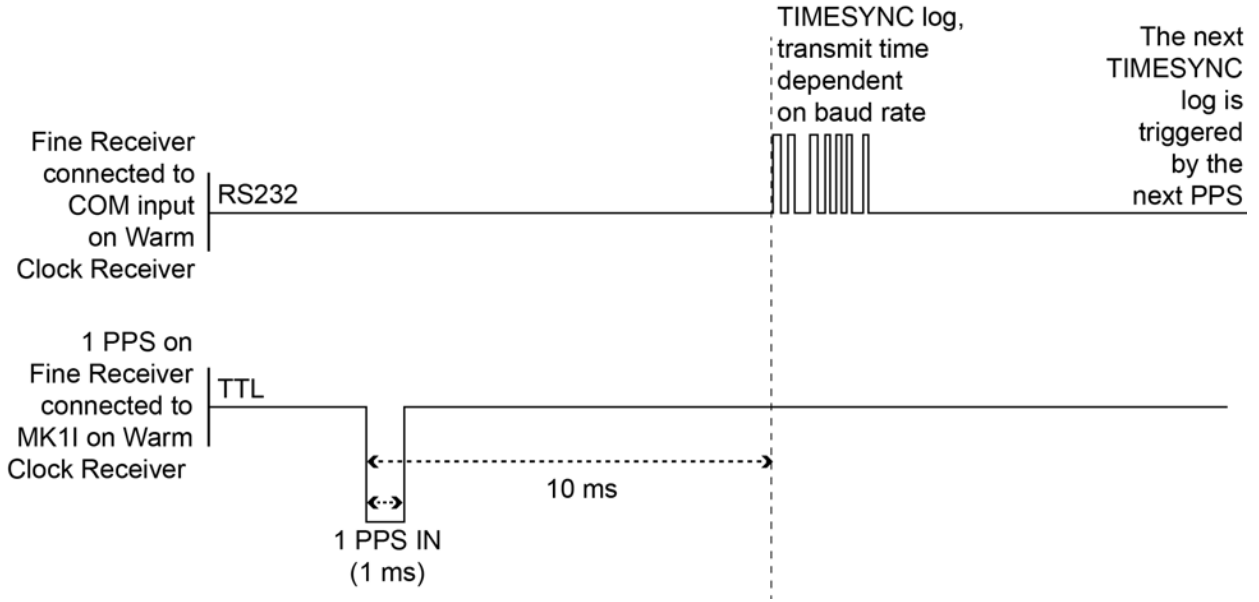

The 1PPS is obtained from different receivers in different ways.



In *Figure 2: 1PPS Alignment* above, the examples are for the transfer of time. If you need position, you must be tracking satellites and your receiver must have a valid almanac.

Alternatively, the 1PPS signal can be set up to be output on a COM port using the **COMCONTROL** command (see page 108). The accuracy of the 1PPS is less using this method, but may be more convenient in some circumstances.

**Table 12:  
COM Port Signals Available for 1PPS**

| OEM719  | OEM729   | OEM7700  | OEM7720  |
|---------|----------|----------|----------|
| COM1 Tx | COM1 Tx  | COM1 Tx  | COM1 Tx  |
| COM2 Tx | COM2 Tx  | COM2 Tx  | COM2 Tx  |
|         | COM2 RTS | COM2 RTS | COM2 RTS |
|         | COM3 Tx  | COM3 Tx  | COM3 Tx  |
|         |          | COM4 Tx  | COM4 Tx  |
|         |          | COM5 Tx  | COM5 Tx  |

To find out the time of the last 1PPS output signal, use the TIMESYNCA/B output message (see the **TIMESYNC** log on page 825) which can be output serially on any available COM port, for example:

```
LOG COM1 TIMESYNCA ONTIME 1
```

**Message ID: 429****Abbreviated ASCII Syntax:**

```
ADJUST1PPS mode [period] [offset]
```

**Factory Default:**

```
ADJUST1PPS OFF
```

**ASCII Example:**

```
ADJUST1PPS MARK CONTINUOUS 250
```



Use the **ADJUST1PPS** command to synchronize two OEM7 cards in a primary/secondary relationship to a common external clock.

**At the Primary Receiver:**

```
LOG COM2 TIMESYNCa ONTIME 1
```

```
interfacemode com2 novatel novatel none
```

```
clockadjust DISABLE
```

```
EXTERNALCLOCK OCXO 10mhz (choose rubidium, cesium or user instead and choose 5MHz instead if necessary)
```

**At the Secondary Receiver:**

```
interfacemode com2 novatel novatel none
```

```
CLOCKADJUST DISABLE
```

```
adjust1pps mark (or markwithtime or time depending on your connection (see Figure 3: ADJUST1PPS Connections on page 58))
```

```
EXTERNALCLOCK OCXO 10mhz (you can choose rubidium, cesium or user instead and choose 5MHz instead if necessary)
```

**Connections:**

Null modem cable connected from Primary COM2 to Secondary COM2

OCXO signal sent through a splitter to feed both the Primary and Secondary external clock inputs

Primary 1PPS connected to Secondary MKI

Connect everything before applying power. If power is applied and the OEM7 receivers have acquired satellites before the OCXO and/or 1PPS = MKI is set up, the times reported by the TIMESYNC logs still diverge. Note that after the clock model was stabilized at state 0, the time difference between the Primary and Secondary reported by the TIMESYNC log was less than 10 ns.



When connecting two receivers to transfer time, disable responses on the COM port used to connect the receivers by issuing the following command on both receivers:

```
interfacemode com2 novatel novatel none
```





The following examples are for the transfer of time. If you need position, you must be tracking satellites and your receiver must have a valid almanac.

**Figure 3: ADJUST1PPS Connections**

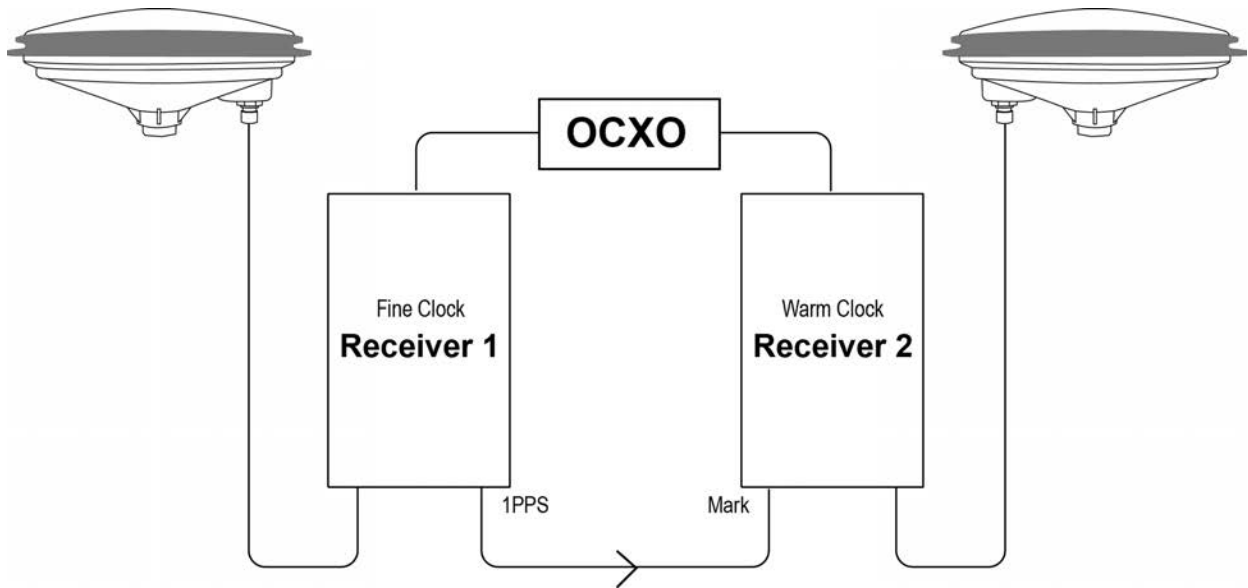

`adjust1pps mark` (if Receiver 2 is not in coarsetime, the input is ignored)

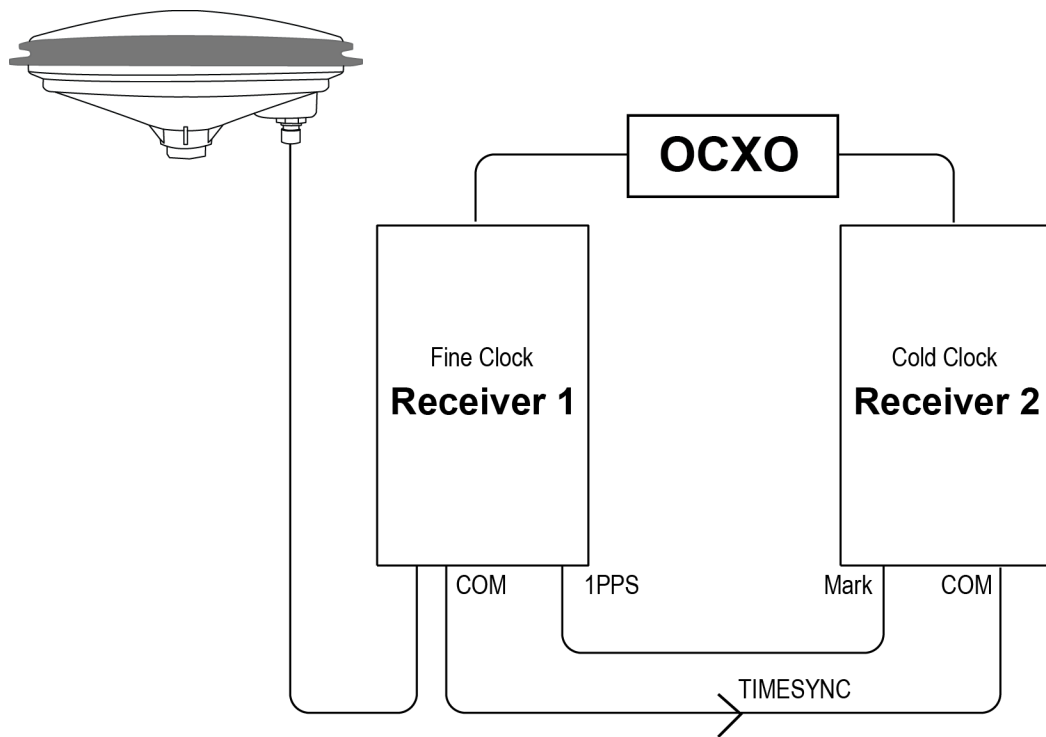

`adjust1pps markwithtime` (will get to finetime)

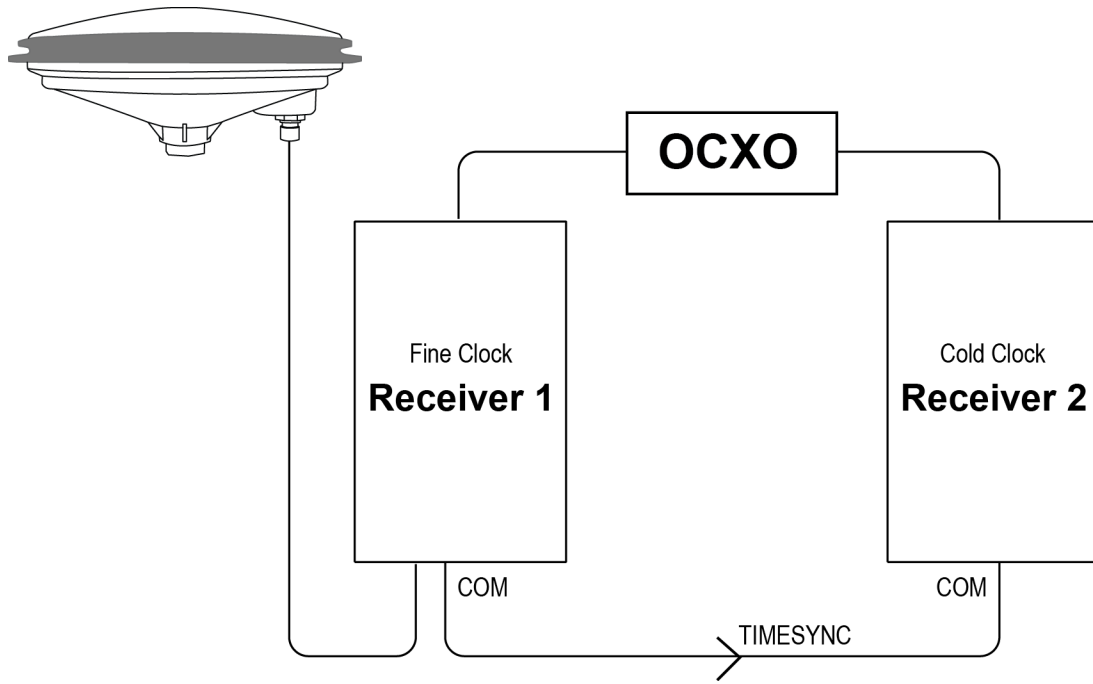

`adjust1pps time` (will only get to coarsetime)

| Field | Field Type         | ASCII Value   | Binary Value | Description   | Format | Binary Bytes | Binary Offset |
|-------|--------------------|---|--------------|---|--------|--------------|---------------|
| 1     | ADJUST 1PPS header | -   | -            | Command header. See <i>Messages</i> on page 25 for more information.  | -      | H            | 0             |
| 2     | mode               | See <i>Table 13: ADJUST1PPS Mode</i> on the next page |              | Sets the ADJUST1PPS mode.   | Enum   | 4            | H             |
| 3     | period             | ONCE  | 0            | The time is synchronized only once (default). The <b>ADJUST1PPS</b> command must be reissued if another synchronization is required | Enum   | 4            | H+4           |
|       |                    | CONTINUOUS  | 1            | The time is continuously monitored and the receiver clock is corrected if an offset of more than 50 ns is detected                  |        |              |               |

| Field | Field Type | ASCII Value                     | Binary Value | Description   | Format | Binary Bytes | Binary Offset |
|-------|------------|---------------------------------|--------------|---|--------|--------------|---------------|
| 4     | offset     | -2147483648 to +2147483647 (ns) |              | Allows the operator to shift the Secondary clock in 20 ns increments. In MANUAL mode, this command applies an immediate shift of this offset in ns to the receiver clock. In MARK and MARKWITHTIME mode, this offset shifts the receiver clock with respect to the time of arrival of the MK1I event. If this offset is zero, the Secondary aligns its 1PPS to that of the signal received in its MK1I port. For example, if this value was set to 50, then the Secondary would set its 1PPS 50 ns ahead of the input signal and if this value was set to -100 then the would set its clock to 100 ns behind the input signal. Typically, this offset is used to correct for cable delay of the 1PPS signal (default=0) | Long   | 4            | H+8           |

**Table 13: ADJUST1PPS Mode**

| ASCII Value | Binary Value | Description  |
|-------------|--------------|--|
| OFF         | 0            | Disables ADJUST1PPS  |
| MANUAL      | 1            | Immediately shifts the receivers time by the offset field in ns. The period field has no effect in this mode. This command does not affect the clock state |

| ASCII Value               | Binary Value | Description   |
|---------------------------|--------------|---|
| MARK <sup>1</sup>         | 2            | Shifts the receiver time to align its 1PPS with the signal received in the MK1I port adjusted by the offset field in ns. The effective shift range is $\pm 0.5$ s   |
| MARKWITHTIME <sup>2</sup> | 3            | Shifts the receiver time to align its 1PPS with the signal received in the MK1I port adjusted by the offset field in ns, and sets the receiver TOW and week number, to that embedded in a received <b>TIMESYNC</b> log (see page 825). Also sets the receiver Time Status to that embedded in the <b>TIMESYNC</b> log (see page 825), which must have arrived between 800 and 1000 ms prior to the MK1I event (presumably the 1PPS from the Primary), or it is rejected as an invalid message |
| TIME                      | 4            | If the receiver clock is not at least COARSEADJUSTED, this command enables the receiver to COARSE adjust its time upon receiving a valid <b>TIMESYNC</b> log (see page 825) in any of the ports. The clock state embedded in the <b>TIMESYNC</b> log (see page 825) must be at least FINE or FINESTEERING before it is considered. The receiver does not use the MK1I event in this mode  |

<sup>1</sup>Only the MK1I input can be used to synchronize the 1PPS signal. Synchronization cannot be done using the MK2I input offered on some receivers.

<sup>2</sup>It is presumed that the **TIMESYNC** log (see page 825) was issued by a Primary GNSS receiver within 1000 ms but not less than 800 ms, of the last 1PPS event, see *Figure 2: 1PPS Alignment* on page 55 and *TIMESYNC* on page 825. Also refer to the Transfer Time Between Receivers section in the [OEM7 Installation and Operation User Manual](#).

## 2.6 ALIGNAUTOMATION

### *Configures ALIGN plug-and-play feature*

**Platform: OEM719, OEM729, OEM7500, OEM7700, OEM7720, PwrPak7, HxGN PIM7500**

This command configures the ALIGN plug and play feature. Use this command to enable/disable the plug and play feature, to set the rover COM port to which master is connected, to set the baud rate for communication, to set the intended operation rate using this command and to enable/disable sending the HEADINGEXTB/HEADINGEXT2B back to the Master receiver. Refer to the NovAtel application note [APN-048](#) for details on HEADINGEXT (available on our website at [www.novatel.com/support/](http://www.novatel.com/support/)).

On issuing this command at the ALIGN Rover, the Rover will automatically sync with the Master and configure it to send corrections at the specified baud rate and specified data rate.



This command should only be issued at ALIGN Rover.

**Message ID: 1323**

#### Abbreviated ASCII Syntax:

```
ALIGNAUTOMATION option [comport] [baudrate] [datarate] [headingextboption]
[interfacemode]
```

#### Factory Default:

```
ALIGNAUTOMATION disable
```

#### Example:

```
ALIGNAUTOMATION enable com2 230400 10 ON
```

| Field | Field Type              | ASCII Value        | Binary Value | Description   | Format | Binary Bytes | Binary Offset |
|-------|-------------------------|--------------------|--------------|---|--------|--------------|---------------|
| 1     | ALIGN AUTOMATION header | -                  | -            | Command header. See <i>Messages</i> on page 25 for more information.  | -      | H            | 0             |
| 2     | option                  | ENABLE             | 1            | Enable or disable the plug-and-play feature   | Enum   | 4            | H             |
|       |                         | DISABLE            | 0            |   |        |              |               |
| 3     | comport                 | COM1, COM2 or COM3 |              | Rover COM port to which master is connected ( <i>Table 58: COM Port Identifiers</i> on page 327) (default=COM2) | Enum   | 4            | H+4           |

| Field | Field Type         | ASCII Value  | Binary Value | Description   | Format | Binary Bytes | Binary Offset |
|-------|--------------------|--|--------------|---|--------|--------------|---------------|
| 4     | baudrate           | 9600, 19200, 38400, 57600, 115200, 230400 or 460800          |              | Intended baud rate for data transmission (default=230400)                           | Ulong  | 4            | H+8           |
| 5     | datarate           | 1, 2, 4, 5, 10 or 20   |              | Rate (in Hz) at which heading output is required (default=10 Hz)                    | Ulong  | 4            | H+12          |
| 6     | headingextb option | OFF  | 0            | Enable or disable sending HEADINGEXTB/ HEADINGEXT2B back to the Master (default=ON) | Enum   | 4            | H+16          |
|       |                    | ON   | 1            |   |        |              |               |
| 7     | interfacemode      | See <i>Table 41: Serial Port Interface Modes</i> on page 192 |              | Serial port interface mode (default=None)   | Enum   | 4            | H+20          |

## 2.7 ANTENNAPOWER

### *Controls power to the antenna*

**Platform:** OEM719, OEM729, OEM7500, OEM7700, OEM7720, PwrPak7, HxGN PIM7500

This command enables or disables the supply of electrical power from the internal power source of the receiver to the Low Noise Amplifier (LNA) of an active antenna. Refer to the [OEM7 Installation and Operation User Manual](#) for further information about supplying power to the antenna.

There are several bits in the receiver status that pertain to the antenna (see *Table 155: Receiver Status* on page 739). These bits indicate whether the antenna is powered and whether it is open circuited or short circuited.

**Message ID: 98**

**Abbreviated ASCII Syntax:**

```
ANTENNAPOWER switch
```

**Factory Default:**

```
ANTENNAPOWER ON
```

**ASCII Examples:**

```
ANTENNAPOWER ON
```

```
ANTENNAPOWER OFF
```



If a short circuit or other problem causes an overload of the current supplied to the antenna, the receiver hardware shuts down the power supplied to the antenna. To restore power, power cycle the receiver. The Receiver Status word, available in the **RXSTATUS** log (see page 734), provides more information about the cause of the problem.

| Field | Field Type          | ASCII Value | Binary Value | Description  | Format | Binary Bytes | Binary Offset |
|-------|---------------------|-------------|--------------|--|--------|--------------|---------------|
| 1     | ANTENNAPOWER header | -           | -            | Command header. See <i>Messages</i> on page 25 for more information. | -      | H            | 0             |



| Field | Field Type | ASCII Value                          | Binary Value | Description  | Format | Binary Bytes | Binary Offset |
|-------|------------|--------------------------------------|--------------|--|--------|--------------|---------------|
| 2     | switch     | OFF                                  | 0            | Disables antenna power<br>On OEM7720, disables antenna power for both antennas                   | Enum   | 4            | H             |
|       |            | ON                                   | 1            | Enables antenna power (5V)<br>On OEM7720, enables antenna power for both antennas                |        |              |               |
|       |            | PRIMARY_<br>ON_<br>SECONDARY_<br>OFF | 3            | Enables primary antenna power and disables secondary antenna power<br><b>Note:</b> OEM7720 only. |        |              |               |
|       |            | PRIMARY_<br>OFF_<br>SECONDARY_<br>ON | 4            | Disables primary antenna power and enables secondary antenna power<br><b>Note:</b> OEM7720 only  |        |              |               |

## 2.8 ASSIGN

### *Assigns a channel to a PRN*

**Platform: OEM719, OEM729, OEM7500, OEM7700, OEM7720, PwrPak7, HxGN PIM7500**



1. The **ASSIGN** command should only be used by advanced users.
2. Assigning SV channel sets the forced assignment bit in the channel tracking status field which is reported in the RANGE and TRACKSTAT logs.
3. Assigning a PRN to a SV channel does not remove the PRN from the search space of the automatic searcher; only the SV channel is removed (that is, the searcher may search and lock onto the same PRN on another channel). See *Table 10: PRN Numbers for Commands and Logs* on page 46 for the PRN available for the **ASSIGN** command.
4. GLONASS SVs cannot be assigned if there is no information on GLONASS frequencies and matching slot numbers.

This command may be used to aid in the initial acquisition of a satellite by manually overriding the automatic satellite/channel assignment and reacquisition processes. The command specifies that the indicated tracking channel search for a specified satellite, at a specified Doppler frequency, within a specified Doppler window.

The instruction remains in effect for the specified SV channel and PRN, even if the assigned satellite subsequently sets. If the satellite Doppler offset of the assigned SV channel exceeds that specified by the window parameter of the **ASSIGN** command, the satellite may never be acquired or reacquired. If a PRN has been assigned to a channel and the channel is currently tracking that satellite, when the channel is set to AUTO tracking, the channel immediately idles and returns to automatic mode.

To cancel the effects of **ASSIGN**, issue one of the following:

- The **ASSIGN** command with the state set to AUTO
- The **UNASSIGN** command (see page 368)
- The **UNASSIGNALL** command (see page 370)

These immediately return SV channel control to the automatic search engine

**Message ID: 27**

#### **Abbreviated ASCII Syntax:**

```
ASSIGN channel [state] [prn [Doppler [Doppler window]]]
```

#### **ASCII Example 1:**

```
ASSIGN 0 ACTIVE 29 0 2000
```

In example 1, the first SV channel is searching for satellite PRN 29 in a range from -2000 Hz to 2000 Hz until the satellite signal is detected.

#### **ASCII Example 2:**

```
ASSIGN 11 28 -250 0
```

SV channel 11 is searching for satellite PRN 28 at an offset of -250 Hz only.

### ASCII Example 3:

```
ASSIGN 11 IDLE
```

SV channel 11 is idled and does not attempt to search for satellites.



OEM7 cards have 4 channels available for SBAS. They automatically use the healthy GEO satellites with the highest elevations. Use the **ASSIGN** command to enter a GEO PRN manually.



For dual antenna receivers, when using the ASSIGN command for SV channels on the primary antenna, the SV channel count goes from 0 to N-1, where N is the number of channels in the primary antenna channel configuration. When using the ASSIGN command for channels on the secondary antenna, the SV channel count begins at N and goes to N+(M-1), where M is the number of channels in the secondary antenna SV channel configuration.

| Field | Field Type    | ASCII Value  | Binary Value | Description  | Format | Binary Bytes | Binary Offset |
|-------|---------------|--|--------------|--|--------|--------------|---------------|
| 1     | ASSIGN header | -  | -            | Command header. See <i>Messages</i> on page 25 for more information.   | -      | H            | 0             |
| 2     | channel       | 0 to n-1, where n is the maximum number of channels in the current channel configuration |              | Desired SV channel number where channel 0 is the first SV channel. The last channel depends on your model configuration              | Ulong  | 4            | H             |
| 3     | state         | Refer to <i>Table 14: Channel State</i> on the next page                                 |              | Set the SV channel state. If a value is not given, the default of ACTIVE is used when the additional optional parameters are entered | Enum   | 4            | H+4           |
| 4     | prn           | Refer to <i>PRN Numbers</i> on page 46   |              | Optional satellite PRN number. A value must be entered unless the state parameter is IDLE or AUTO                                    | Ulong  | 4            | H+8           |

| Field | Field Type     | ASCII Value            | Binary Value | Description   | Format | Binary Bytes | Binary Offset |
|-------|----------------|------------------------|--------------|---|--------|--------------|---------------|
| 5     | Doppler        | -100 000 to 100 000 Hz |              | Current Doppler offset of the satellite (default=0)<br><b>Note:</b> Satellite motion, receiver antenna motion and receiver clock frequency error must be included in the calculation of Doppler frequency | Long   | 4            | H+12          |
| 6     | Doppler window | 0 to 10 000 Hz         |              | Error or uncertainty in the Doppler estimate above. (default=4500)<br><b>Note:</b> This is a $\pm$ value. Example: 500 for $\pm$ 500 Hz   | Ulong  | 4            | H+16          |

**Table 14: Channel State**

| Binary | ASCII               | Description   |
|--------|---------------------|---|
| 0      | IDLE                | Set the SV channel to not track any satellites                    |
| 1      | ACTIVE <sup>1</sup> | Set the SV channel active (default)                               |
| 2      | AUTO                | Tell the receiver to automatically assign PRN numbers to channels |

<sup>1</sup>A PRN number is required when using the ACTIVE channel state in this command.

## 2.9 ASSIGNALL

### *Assigns all channels to a PRN*

**Platform: OEM719, OEM729, OEM7500, OEM7700, OEM7720, PwrPak7, HxGN PIM7500**



The **ASSIGNALL** command should only be used by advanced users.

This command is used to override the automatic satellite/channel assignment and reacquisition processes for all receiver channels with manual instructions.

**Message ID: 28**

#### Abbreviated ASCII Syntax:

```
ASSIGNALL [system][state][prn [Doppler [Doppler window]]]
```

#### ASCII Example 1:

```
ASSIGNALL GLONASS IDLE
```

In example 1, all GLONASS channels are idled, essentially stopping the receiver from tracking GLONASS.

#### ASCII Example 2:

```
ASSIGNALL GLONASS AUTO
```

In example 2, all GLONASS channels are enabled in auto mode. This enables the receiver to automatically assign channels to track the available GLONASS satellites.



This command is the same as ASSIGN except that it affects all SV channels of the specified system.



These command examples are only applicable to specific receiver models. If the system field is used with this command and the receiver has no channels configured with that channel system, the command is rejected.

| Field | Field Type        | ASCII Value | Binary Value | Description  | Format | Binary Bytes | Binary Offset |
|-------|-------------------|-------------|--------------|--|--------|--------------|---------------|
| 1     | ASSIGN-ALL header | -           | -            | Command header. See <i>Messages</i> on page 25 for more information. | -      | H            | 0             |

| Field | Field Type     | ASCII Value   | Binary Value | Description  | Format | Binary Bytes | Binary Offset |
|-------|----------------|---|--------------|--|--------|--------------|---------------|
| 2     | system         | See <i>Table 15: Channel System</i> below           |              | System that SV channel is tracking. If no value is specified, the value defaults to ALL  | Enum   | 4            | H             |
| 3     | state          | Refer to <i>Table 14: Channel State</i> on page 68) |              | Set the SV channel state   | Enum   | 4            | H+4           |
| 4     | prn            | Refer to <i>PRN Numbers</i> on page 46              |              | Optional satellite PRN code. A value must be entered if the state parameter is neither IDLE or AUTO  | Ulong  | 4            | H+8           |
| 5     | Doppler        | -100 000 to 100 000 Hz                              |              | Current Doppler offset of the satellite (default=0)<br><b>Note:</b> Satellite motion, receiver antenna motion and receiver clock frequency error must be included in the calculation of Doppler frequency. | Long   | 4            | H+12          |
| 6     | Doppler window | 0 to 10 000 Hz                                      |              | Error or uncertainty in the Doppler estimate above. (default=4500)<br><b>Note:</b> This is a $\pm$ value<br>Example, 500 for $\pm$ 500 Hz  | Ulong  | 4            | H+16          |

**Table 15: Channel System**

| Binary | ASCII   | Description    |
|--------|---------|----------------|
| 3      | ALL     | All systems    |
| 99     | GPS     | GPS system     |
| 100    | SBAS    | SBAS system    |
| 101    | GLONASS | GLONASS system |
| 102    | GALILEO | GALILEO system |
| 103    | BeiDou  | BeiDou system  |

| Binary | ASCII | Description  |
|--------|-------|--------------|
| 104    | QZSS  | QZSS system  |
| 105    | NAVIC | NavIC system |



GLONASS SVs cannot be assigned if there is no information on GLONASS frequencies and matching slot numbers.

## 2.10 ASSIGNLBANDBEAM

### Configure L-Band tracking

**Platform: OEM719, OEM729, OEM7500, OEM7700, OEM7720, PwrPak7, HxGN PIM7500**

This command assigns TerraStar or Veripos beams to the L-Band channels based on the defined L-Band assignment option.



Logging the **ASSIGNLBANDBEAM** command may not display the correct values. To access the actual beam name, frequency and baud rate values, log the **LBANDTRACKSTAT** log (see page 561) or if the beam name is known, log the **LBANDBEAMTABLE** log (see page 557) and find the associated frequency and baud rate.

**Message ID: 1733**

#### Abbreviated ASCII Syntax:

```
ASSIGNLBANDBEAM [option] [name] [frequency] [baudrate] [Dopplerwindow]
```

#### Factory Default:

```
ASSIGNLBANDBEAM idle
```

#### ASCII Examples:

```
ASSIGNLBANDBEAM auto
```

```
ASSIGNLBANDBEAM 98W
```

```
ASSIGNLBANDBEAM manual 98w 1539902500 1200
```

| Field | Field Type             | Description   | Format  | Binary Bytes | Binary Offset |
|-------|------------------------|---|---------|--------------|---------------|
| 1     | ASSIGNLBANDBEAM header | Command header. See <i>Messages</i> on page 25 for more information.                                | -       | H            | 0             |
| 2     | Option                 | Assignment option (see <i>Table 16: L-Band Assignment Option</i> on the next page) (manual=default) | Enum    | 4            | H             |
| 3     | Name                   | Beam name (empty string=default)  | Char[8] | 8            | H+4           |
| 4     | Frequency              | Beam frequency in Hz (0=default)  | Ulong   | 4            | H+12          |
| 5     | Baud rate              | Data baud rate (0=default)  | Ulong   | 4            | H+16          |
| 6     | Doppler window         | Doppler window to search (6000=default)   | Ulong   | 4            | H+20          |



**Table 16: L-Band Assignment Option**

| ASCII  | Binary | Description   |
|--------|--------|---|
| IDLE   | 0      | Idle all L-Band channels  |
| AUTO   | 1      | <p>The receiver searches for multiple L-Band beams on the L-Band channels based on AUTO selection criteria.</p> <p>If the receiver position is known, the AUTO selection criteria is a ranking of granted access L-Band beams by descending elevation angle.</p> <p>If the receiver position is not known, the AUTO selection criteria is a ranking of granted access L-Band beams in the order they appear in the stored beam table (see the <b>LBANDBEAMTABLE</b> log on page 557).</p> |
| MANUAL | 2      | The receiver assigns the specified beam on the first L-BAND channel and makes the other L-BAND channels IDLE.   |

## 2.11 AUTH

### *Authorization code for different model*

**Platform: OEM719, OEM729, OEM7500, OEM7700, OEM7720, PwrPak7, HxGN PIM7500**

This command is used to add or remove authorization codes from the receiver. Authorization codes are used to authorize models of software for a receiver. Models control the functionality the receiver provides. The RECEIVER is capable of keeping track of 24 authorization codes at one time. The **MODEL** command (see page 232) can then be used to switch between authorized models. The **VALIDMODELS** command (see page 831) lists the current available models in the receiver. The **AUTHCODES** log (see page 401) lists all Authorization codes entered into the receiver. This simplifies the use of multiple software models on the same receiver.

If there is more than one valid model in the receiver, the receiver either uses the model of the last auth code entered via the **AUTH** command or the model that was selected by the **MODEL** command, whichever was done last. Adding an Authorization Code or using the **MODEL** command causes an automatic reset of the receiver. Removing an Authorization Code does not cause a reset.



Removing an authorization code will cause the receiver to permanently lose this information.

**Message ID: 49**

**Abbreviated ASCII Syntax:**

```
AUTH [state] part1 part2 part3 part4 part5 model [date]
```

**Input Example:**

```
AUTH add T48JF2,W25DBM,JH46BJ,2WGHMJ,8JW5TW,G2SR0RCCR,101114
```

```
AUTH erase_table PW5W2B,WW5TM9,WW2PCZ,WW3M4H,WW4HPG,ERASE_AUTH
```



When you are ready to upgrade from one model to another, call 1-800-NOVATEL to speak with our Customer Support/Sales Personnel, who can provide the authorization code that unlocks the additional features of your GNSS receiver. This procedure can be performed at your work site and takes only a few minutes.



Receiver models can also be downgraded. This is a two step handshaking process and is best performed in a location with e-mail access.

| Field | Field Type  | ASCII Value                                   | Binary Value    | Description  | Format           | Binary Bytes          | Binary Offset |
|-------|-------------|---|-----------------|--|------------------|-----------------------|---------------|
| 1     | AUTH header | -   | -               | Command header. See <i>Messages</i> on page 25 for more information. | -                | H                     | 0             |
| 2     | state       | See Table 17: <i>AUTH Command State</i> below |                 | Auth code function to perform  | Enum             | 4                     | H             |
| 3     | part1       | 6 character ASCII string                      |                 | Authorization code section 1   | String [max. 16] | Variable <sup>1</sup> | H+4           |
| 4     | part2       | 6 character ASCII string                      |                 | Authorization code section 2   | String [max. 16] | Variable <sup>1</sup> | H+20          |
| 5     | part3       | 6 character ASCII string                      |                 | Authorization code section 3   | String [max. 16] | Variable <sup>1</sup> | H+36          |
| 6     | part4       | 6 character ASCII string                      |                 | Authorization code section 4   | String [max. 16] | Variable <sup>1</sup> | H+52          |
| 7     | part5       | 6 character ASCII string                      |                 | Authorization code section 5   | String [max. 16] | Variable <sup>1</sup> | H+68          |
| 8     | model       | Alpha numeric                                 | Null terminated | Model name of the receiver   | String [max. 16] | Variable <sup>1</sup> | H+84          |
| 9     | date        | Numeric                                       | Null terminated | Expiry date entered as yymmdd in decimal                             | String [max 7]   | Variable <sup>1</sup> | Variable      |

**Table 17: AUTH Command State**

| ASCII  | Binary | Description   |
|--------|--------|---|
| REMOVE | 0      | Remove the authcode from the system<br><div style="border: 1px solid black; padding: 5px; margin-top: 10px;">  For this parameter, the Part1-Part5 fields can be entered as 0 0 0 0, and only the model name entered. </div> |
| ADD    | 1      | Add the authcode to the system (default)  |

<sup>1</sup>In the binary case, each string field needs to be NULL terminated and additional bytes of padding added to maintain 4-byte alignment, up to the maximum defined by the string size. The next defined field starts immediately at the next 4-byte alignment following the NULL.

| ASCII            | Binary | Description  |
|------------------|--------|--|
| ADD_<br>DOWNLOAD | 4      | Add the authcode to the system (Deprecated: Use ADD instead)   |
| ERASE_<br>TABLE  | 7      | <p>Erase all auth codes from the system. Requires a special auth code to prevent against accidental erasing.</p> <div style="border: 1px solid black; padding: 5px; background-color: #f0f0f0;">  The special auth code required for this option is:<br/>PW5W2B,WW5TM9,WW2PCZ,WW3M4H,WW4HPG,ERASE_<br/>AUTH </div>  |
| CLEAN_<br>TABLE  | 8      | <p>Remove all invalidated auth codes from the system.</p> <p>When an auth code is removed, it is simply invalidated and so it still uses one of the 24 spaces reserved for auth codes in the receiver. Use the CLEAN_TABLE option to free up the spaces from removed auth codes.</p> <div style="border: 1px solid black; padding: 5px; background-color: #f0f0f0;">  The special auth code required for this option is:<br/>4DR69H,G369W8,34MNJJ,5NHXCJ,GW7C75,CLEAN_AUTH </div> |

## 2.12 AUTOSURVEY

### *Survey for accurate position*

**Platform: OEM719, OEM729, OEM7500, OEM7700, OEM7720, PwrPak7, HxGN PIM7500**

The **AUTOSURVEY** command uses position averaging to automatically determine the position for a base station.

When the **AUTOSURVEY** command is sent, the receiver starts position averaging. The position averaging continues until a specified accuracy level is met or until the specified survey time expires. When position averaging is complete, the calculated position is saved as the fix position for the base station. This calculated position is then used when transmitting differential corrections to the rover.



If the **FIX** command is entered by a user, the **SAVECONFIG** command must then be issued to save to NVM. If the **FIX** command is issued by the AUTOSURVEY feature, the **SAVECONFIG** command does not need to be issued.

On subsequent power ups or resets, an AUTOSURVEY runs to determine if the base station has moved. As the AUTOSURVEY runs, the average position calculated is compared to the saved fix position. If the average position is within the AUTOSURVEY tolerance setting, the receiver assumes it has not moved and uses the previously saved fix position. If the average position is outside of the AUTOSURVEY tolerance setting, the receiver assumes it has moved and will continue calculating a position average until the accuracy level is met or until the specified survey time expires.

**Message ID: 1795**

#### **Abbreviated ASCII Syntax:**

```
AUTOSURVEY control [time] [accuracy] [tolerance] [save_nvm] [position_id]
```

#### **Input Example:**

In the following example, the receiver is set up to survey its position for up to 24 hours or until the averaged position accuracy is 10 cm. On subsequent power ups at the same location, the survey will terminate as soon as the receiver determines the position is within 4 m of its surveyed position. Once the receiver has fixed its position, it will transmit RTCM V3 corrections over COM2.

```
SERIALCONFIG COM2 115200 N 8 1 N ON
INTERFACEMODE COM2 NONE RTCMV3 OFF
LOG COM2 RTCM1004 ONTIME 1
LOG COM2 RTCM1006 ONTIME 10
LOG COM2 RTCM1019 ONTIME 120
AUTOSURVEY ENABLE 1440 .1 4
SAVECONFIG
```

| Field | Field Type        | ASCII Value        | Binary Value | Description   | Format     | Binary Bytes   | Binary Offset |
|-------|-------------------|--------------------|--------------|---|------------|----------------|---------------|
| 1     | AUTOSURVEY header | -                  | -            | Command header. See <i>Messages</i> on page 25 for more information.  | -          | H              | 0             |
| 2     | control           | disable            | 0            | Disables the self-survey feature and halts any self-survey related activity (default = disable)   | Enum       | 4              | H             |
|       |                   | enable             | 1            | Enables the self-survey feature   |            |                |               |
| 3     | time              | 1 - 6000 minutes   |              | Maximum amount of time to perform self-survey (default = 1440 minutes)  | Ulong      | 4              | H+4           |
| 4     | accuracy          | 0 - 100 metres     |              | Desired horizontal standard deviation (default = 0.1 metres)  | Float      | 4              | H+8           |
| 5     | tolerance         | 3 - 100 metres     |              | Maximum distance between calculated position and saved position. During the self-survey, if the distance between the calculated position and the previously surveyed position is less than this value, the previous position is used. (default = 10 metres) | Float      | 4              | H+12          |
| 6     | save_nvm          | OFF                | 0            | Do not save position in NVM   | Enum       | 4              | H+16          |
|       |                   | ON                 | 1            | Save position in NVM (default = ON)   |            |                |               |
| 7     | position_id       | 4 character string |              | ID for the saved position. If the ID is not specified or if the ID is entered as "AUTO", receiver automatically generates a unique ID for the position  | String [5] | 5 <sup>1</sup> | H+20          |

<sup>1</sup>In the binary case, each string field needs to be NULL terminated and additional bytes of padding added to maintain 4-byte alignment, up to the maximum defined by the string size. The next defined field starts immediately at the next 4-byte alignment following the NULL.

## 2.13 BASEANTENNAPCO

*Sets the PCO model of the base receiver*

**Platform: OEM719, OEM729, OEM7500, OEM7700, OEM7720, PwrPak7, HxGN PIM7500**

Use the **BASEANTENNAPCO** command to set the Phase Center Offsets (PCO) for a given frequency on the remote base receiver from which this receiver is receiving corrections. The Offsets are defined as North, East and Up from the Antenna Reference Point to the Frequency Phase Center in millimetres.

**Message ID: 1415**

### Abbreviated ASCII Syntax:

```
BASEANTENNAPCO Frequency NorthOffset EastOffset UpOffset [CorrectionType
[StationId]]
```

### ASCII Example:

```
BASEANTENNAPCO GPSL1 0.61 1.99 65.64
```

| Field | Field Type            | ASCII Value  | Binary Value | Description  | Format | Binary Bytes | Binary Offset |
|-------|-----------------------|--|--------------|--|--------|--------------|---------------|
| 1     | BASEANTENNAPCO header | -  | -            | Command header. See <i>Messages</i> on page 25 for more information. | -      | H            | 0             |
| 2     | Frequency             | See <i>Table 18: Frequency Type</i> on the next page |              | The frequency that the phase center offsets are valid for.           | Enum   | 4            | H             |
| 3     | NorthOffset           |  |              | NGS standard Phase Center North Offset in millimetres.               | Double | 8            | H+4           |
| 4     | EastOffset            |  |              | NGS standard Phase Center East Offset in millimetres.                | Double | 8            | H+12          |
| 5     | UpOffset              |  |              | NGS standard Phase Center Up Offset in millimetres.                  | Double | 8            | H+20          |
| 6     | CorrectionType        | See <i>Table 52: DGPS Type</i> on page 276           |              | Correction type (default = AUTO)                                     | Enum   | 4            | H+28          |
| 7     | StationID             | Char [8] or ANY                                      |              | ID string for the base station (default = ANY)                       | Char   | 8            | H+32          |

**Table 18: Frequency Type**

| <b>Value</b> | <b>Name</b> | <b>Description</b>       |
|--------------|-------------|--------------------------|
| 0            | GPSL1       | GPS L1 frequency         |
| 1            | GPSL2       | GPS L2 frequency         |
| 2            | GLONASSL1   | GLONASS L1 frequency     |
| 3            | GLONASSL2   | GLONASS L2 frequency     |
| 5            | GPSL5       | GPS L5 frequency         |
| 7            | GALILEOE1   | Galileo E1 frequency     |
| 8            | GALILEOE5A  | Galileo E5a frequency    |
| 9            | GALILEOE5B  | Galileo E5b frequency    |
| 10           | GALILEOALTB | Galileo AltBOC frequency |
| 11           | BEIDOU B1   | BeiDou B1 frequency      |
| 12           | BEIDOU B2   | BeiDou B2 frequency      |
| 13           | QZSSL1      | QZSS L1 frequency        |
| 14           | QZSSL2      | QZSS L2 frequency        |
| 15           | QZSSL5      | QZSS L5 frequency        |
| 16           | QZSSL6      | QZSS L6 frequency        |
| 17           | GALILEOE6   | Galileo E6 frequency     |
| 18           | BEIDOU B3   | BeiDou B3 frequency      |



## 2.14 BASEANTENNAPCV

*Sets the PCV model of the base receiver*

**Platform: OEM719, OEM729, OEM7500, OEM7700, OEM7720, PwrPak7, HxGN PIM7500**

Use the **BASEANTENNAPCV** command to set the Phase Center Variation (PCV) for a given frequency on the remote base receiver from which this receiver is receiving corrections. The Phase Center Variation entries follow the NGS standard and correspond to the phase elevation at 5 degree increments starting at 90 degrees and decreasing to 0.

**Message ID: 1416**

**Abbreviated ASCII Syntax:**

```
BASEANTENNAPCV Frequency [PCVArray [CorrectionType [StationId]]]
```

**ASCII Example:**

```
BASEANTENNAPCV GPSL1 0.00 -0.020 -0.07 -0.15 -0.24 -0.34 -0.43 -0.51 -0.56 -
0.61 -0.65 -0.69 -0.69 -0.62 -0.44 -0.13 0.28 0.70 1.02
```

| Field | Field Type            | ASCII Value  | Binary Value | Description   | Format      | Binary Bytes | Binary Offset |
|-------|-----------------------|--|--------------|---|-------------|--------------|---------------|
| 1     | BASEANTENNAPCV header | -  | -            | Command header. See <i>Messages</i> on page 25 for more information.  | -           | H            | 0             |
| 2     | Frequency             | See <i>Table 18: Frequency Type</i> on the previous page |              | The frequency for which the phase center variations are valid.  | Enum        | 4            | H             |
| 3     | PCVArray              |  |              | NGS standard 19 element array of phase center variations, in millimetres, in 5 degree elevation increments from 90 to 0. Defaults to zero for all elevation increments. | Double [19] | 152          | H+4           |
| 4     | CorrectionType        | See <i>Table 52: DGPS Type</i> on page 276               |              | Correction type (default = AUTO)  | Enum        | 4            | H+156         |
| 5     | StationID             | Char [8] or ANY  |              | ID string (default = ANY)   | Char        | 8            | H+160         |

## 2.15 BASEANTENNATYPE

*Sets the antenna type of the base receiver*

**Platform: OEM719, OEM729, OEM7500, OEM7700, OEM7720, PwrPak7, HxGN PIM7500**

Use the **BASEANTENNATYPE** command to set the antenna type of the remote base receiver from which this receiver is receiving corrections. The Antenna Type and Radome Type are the NGS names for the antenna.



When the antenna type is set using this command, the receiver will look up and use the Phase Center Variations and Phase Center Offsets from an internal table.

**Message ID: 1419**

**Abbreviated ASCII Syntax:**

```
BASEANTENNATYPE AntennaType [RadomeType] [CorrectionType] [StationId]
```

**ASCII Example:**

```
BASEANTENNATYPE NOV702
```

| Field | Field Type             | ASCII Value  | Binary Value | Description  | Format | Binary Bytes | Binary Offset |
|-------|------------------------|--|--------------|--|--------|--------------|---------------|
| 1     | BASEANTENNATYPE header | -  | -            | Command header. See <i>Messages</i> on page 25 for more information. | -      | H            | 0             |
| 2     | AntennaType            | See <i>Table 19: Antenna Type</i> on the next page |              | NGS Antenna Name   | Enum   | 4            | H             |
| 3     | RadomeType             | See <i>Table 20: Radome Type</i> on page 91        |              | NGS Radome Name (default = NONE)                                     | Enum   | 4            | H+4           |
| 4     | CorrectionType         | See <i>Table 52: DGPS Type</i> on page 276         |              | Correction type (default = AUTO)                                     | Enum   | 4            | H+8           |
| 5     | StationID              | Char [8] or ANY                                    |              | ID string (default = ANY)  | Char   | 8            | H+12          |



The latest information can be obtained from the National Geodetic Survey (NGS) site [www.ngs.noaa.gov/ANTCAL](http://www.ngs.noaa.gov/ANTCAL).

**Table 19: Antenna Type**

| Value | Name          | Description  |
|-------|---------------|--|
| 0     | NONE          | No antenna model   |
| 2     | AUTO          | Determine the antenna model from the RTK corrections<br>(Not valid for THISANTENNA TYPE) |
| 3     | AERAT2775_43  |  |
| 4     | AOAD_M_B      |  |
| 5     | AOAD_M_T      | AOAD/M_T   |
| 6     | AOAD_M_TA_NGS | AOAD/M_TA_NGS  |
| 7     | APSAPS-3      |  |
| 8     | ASH700228A    |  |
| 9     | ASH700228B    |  |
| 10    | ASH700228C    |  |
| 11    | ASH700228D    |  |
| 12    | ASH700228E    |  |
| 13    | ASH700699.L1  |  |
| 14    | ASH700700.A   |  |
| 15    | ASH700700.B   |  |
| 16    | ASH700700.C   |  |
| 17    | ASH700718A    |  |
| 18    | ASH700718B    |  |
| 19    | ASH700829.2   |  |
| 20    | ASH700829.3   |  |
| 21    | ASH700829.A   |  |
| 22    | ASH700829.A1  |  |
| 23    | ASH700936A_M  |  |
| 24    | ASH700936B_M  |  |
| 25    | ASH700936C_M  |  |
| 26    | ASH700936D_M  |  |

| Value | Name            | Description |
|-------|-----------------|-------------|
| 27    | ASH700936E      |             |
| 28    | ASH700936E_C    |             |
| 29    | ASH700936F_C    |             |
| 30    | ASH701008.01B   |             |
| 31    | ASH701073.1     |             |
| 32    | ASH701073.3     |             |
| 33    | ASH701933A_M    |             |
| 34    | ASH701933B_M    |             |
| 35    | ASH701933C_M    |             |
| 36    | ASH701941.1     |             |
| 37    | ASH701941.2     |             |
| 38    | ASH701941.A     |             |
| 39    | ASH701941.B     |             |
| 40    | ASH701945B_M    |             |
| 41    | ASH701945C_M    |             |
| 42    | ASH701945D_M    |             |
| 43    | ASH701945E_M    |             |
| 44    | ASH701945G_M    |             |
| 45    | ASH701946.2     |             |
| 46    | ASH701946.3     |             |
| 47    | ASH701975.01A   |             |
| 48    | ASH701975.01AGP |             |
| 49    | JAV_GRANT-G3T   |             |
| 50    | JAV_RINGANT_G3T |             |
| 51    | JAVRINGANT_DM   |             |
| 52    | JNSMARANT_GGD   |             |
| 53    | JPLD/M_R        |             |
| 54    | JPLD/M_RA_SOP   |             |

| <b>Value</b> | <b>Name</b>     | <b>Description</b> |
|--------------|-----------------|--------------------|
| 55           | JPSLEGANT_E     |                    |
| 56           | JPSODYSSSEY_I   |                    |
| 57           | JPSREGANT_DD_E  |                    |
| 58           | JPSREGANT_SD_E  |                    |
| 59           | LEIAR10         |                    |
| 60           | LEIAR25         |                    |
| 61           | LEIAR25.R3      |                    |
| 62           | LEIAR25.R4      |                    |
| 63           | LEIAS05         |                    |
| 64           | LEIAX1202GG     |                    |
| 65           | LEIAS10         |                    |
| 66           | LEIAX1203+GNSS  |                    |
| 67           | LEIAT202+GP     |                    |
| 68           | LEIAT202-GP     |                    |
| 69           | LEIAT302+GP     |                    |
| 70           | LEIAT302-GP     |                    |
| 71           | LEIAT303        |                    |
| 72           | LEIAT502        |                    |
| 73           | LEIAT503        |                    |
| 74           | LEIAT504        |                    |
| 75           | LEIAT504GG      |                    |
| 76           | LEIATX1230      |                    |
| 77           | LEIATX1230+GNSS |                    |
| 78           | LEIATX1230GG    |                    |
| 79           | LEIAX1202       |                    |
| 80           | LEIGG02PLUS     |                    |
| 81           | LEIGS08         |                    |
| 82           | LEIGS09         |                    |

| Value | Name            | Description |
|-------|-----------------|-------------|
| 83    | LEIGS12         |             |
| 84    | 3S-02-TSADM     |             |
| 85    | 3S-02-TSATE     |             |
| 86    | LEIGS15         |             |
| 87    | LEIMNA950GG     |             |
| 88    | LEISR299_INT    |             |
| 89    | LEISR399_INT    |             |
| 90    | LEISR399_INTA   |             |
| 91    | MAC4647942      |             |
| 92    | MPL_WAAS_2224NW |             |
| 93    | MPL_WAAS_2225NW |             |
| 94    | MPLL1_L2_SURV   |             |
| 95    | NAVAN2004T      |             |
| 96    | NAVAN2008T      |             |
| 97    | NAX3G+C         |             |
| 98    | NOV_WAAS_600    |             |
| 99    | NOV501          |             |
| 100   | NOV501+CR       |             |
| 101   | NOV502          |             |
| 102   | NOV502+CR       |             |
| 103   | NOV503+CR       |             |
| 104   | NOV531          |             |
| 105   | NOV531+CR       |             |
| 106   | NOV600          |             |
| 107   | NOV702          |             |
| 108   | NOV702GG        |             |
| 109   | NOV750.R4       |             |
| 110   | SEN67157596+CR  |             |

| Value | Name            | Description |
|-------|-----------------|-------------|
| 111   | SOK_RADIAN_IS   |             |
| 112   | SOK502          |             |
| 113   | SOK600          |             |
| 114   | SOK702          |             |
| 115   | SPP571212238+GP |             |
| 116   | STXS9SA7224V3.0 |             |
| 117   | TOP700779A      |             |
| 118   | TOP72110        |             |
| 119   | TPSCR.G3        |             |
| 120   | TPSCR3_GGD      |             |
| 121   | TPSCR4          |             |
| 122   | TPSG3_A1        |             |
| 123   | TPSHIPER_GD     |             |
| 124   | TPSHIPER_GGD    |             |
| 125   | TPSHIPER_LITE   |             |
| 126   | TPSHIPER_PLUS   |             |
| 127   | TPSLEGANT_G     |             |
| 128   | TPSLEGANT2      |             |
| 129   | TPSLEGANT3_UHF  |             |
| 130   | TPSODYSSEY_I    |             |
| 131   | TPSPG_A1        |             |
| 132   | TPSPG_A1+GP     |             |
| 133   | TRM14177.00     |             |
| 134   | TRM14532.00     |             |
| 135   | TRM14532.10     |             |
| 136   | TRM22020.00+GP  |             |
| 137   | TRM22020.00-GP  |             |
| 138   | TRM23903.00     |             |

| Value | Name           | Description |
|-------|----------------|-------------|
| 139   | TRM27947.00+GP |             |
| 140   | TRM27947.00-GP |             |
| 141   | TRM29659.00    |             |
| 142   | TRM33429.00+GP |             |
| 143   | TRM33429.00-GP |             |
| 144   | TRM33429.20+GP |             |
| 145   | TRM39105.00    |             |
| 146   | TRM41249.00    |             |
| 147   | TRM41249USCG   |             |
| 148   | TRM4800        |             |
| 149   | TRM55971.00    |             |
| 150   | TRM57970.00    |             |
| 151   | TRM57971.00    |             |
| 152   | TRM5800        |             |
| 153   | TRM59800.00    |             |
| 154   | TRM59800.80    |             |
| 155   | TRM59900.00    |             |
| 156   | TRMR8_GNSS     |             |
| 157   | TRMR8_GNSS3    |             |
| 158   | ASH701023.A    |             |
| 159   | CHCC220GR      |             |
| 160   | CHCC220GR2     |             |
| 161   | CHCX91+S       |             |
| 162   | GMXZENITH10    |             |
| 163   | GMXZENITH20    |             |
| 164   | GMXZENITH25    |             |
| 165   | GMXZENITH25PRO |             |
| 166   | GMXZENITH35    |             |



| Value | Name            | Description |
|-------|-----------------|-------------|
| 167   | JAVRINGANT_G5T  |             |
| 168   | JAVTRIUMPH_1M   |             |
| 169   | JAVTRIUMPH_1MR  |             |
| 170   | JAVTRIUMPH_2A   |             |
| 171   | JAVTRIUMPH_LSA  |             |
| 172   | JNSCR_C146-22-1 |             |
| 173   | JPSREGANT_DD_E1 |             |
| 174   | JPSREGANT_DD_E2 |             |
| 175   | JPSREGANT_SD_E1 |             |
| 176   | JPSREGANT_SD_E2 |             |
| 177   | LEIAR20         |             |
| 178   | LEIGG03         |             |
| 179   | LEIGS08PLUS     |             |
| 180   | LEIGS14         |             |
| 181   | LEIICG60        |             |
| 182   | NOV533+CR       |             |
| 183   | NOV703GGG.R2    |             |
| 184   | NOV750.R5       |             |
| 185   | RNG80971.00     |             |
| 186   | SEPCHOKE_B3E6   |             |
| 187   | SEPCHOKE_MC     |             |
| 188   | STXS10SX017A    |             |
| 189   | STXS8PX003A     |             |
| 190   | STXS9PX001A     |             |
| 191   | TIAPENG2100B    |             |
| 192   | TIAPENG2100R    |             |
| 193   | TIAPENG3100R1   |             |
| 194   | TIAPENG3100R2   |             |

| <b>Value</b> | <b>Name</b>   | <b>Description</b> |
|--------------|---------------|--------------------|
| 195          | TPSCR.G5      |                    |
| 196          | TPSG5_A1      |                    |
| 197          | TPSPN.A5      |                    |
| 198          | TRM55970.00   |                    |
| 199          | TRMR10        |                    |
| 200          | TRMR4-3       |                    |
| 201          | TRMR6-4       |                    |
| 202          | TRMR8-4       |                    |
| 203          | TRMR8S        |                    |
| 204          | TRMSPS985     |                    |
| 205          | AERAT1675_120 |                    |
| 206          | ITT3750323    |                    |
| 207          | NOV702GGL     |                    |
| 208          | NOV704WB      |                    |
| 209          | ARFAS1FS      |                    |
| 210          | CHAPS9017     |                    |
| 211          | CHCI80        |                    |
| 212          | GMXZENITH15   |                    |
| 213          | HXCCGX601A    |                    |
| 214          | IGAIG8        |                    |
| 215          | LEICGA60      |                    |
| 216          | LEIGS15.R2    |                    |
| 217          | LEIGS16       |                    |
| 218          | MVEGA152GNSSA |                    |
| 219          | SEPALTUS_NR3  |                    |
| 220          | SJTTL111      |                    |
| 221          | SOKGCX3       |                    |
| 222          | SOKSA500      |                    |

| Value | Name            | Description |
|-------|-----------------|-------------|
| 223   | STHCR3-G3       |             |
| 224   | STXS9I          |             |
| 225   | TPSCR.G5C       |             |
| 226   | TPSHIPER_HR     |             |
| 227   | TPSHIPER_HR+PS  |             |
| 228   | TRM105000.10    |             |
| 229   | TRM115000.00    |             |
| 230   | TRM115000.10    |             |
| 231   | TRMR2           |             |
| 232   | TWIVP6000       |             |
| 233   | TWIVP6050_CONE  |             |
| 234   | JAVTRIUMPH_2A+G |             |

**Table 20: Radome Type**

| Value | Name |
|-------|------|
| 0     | NONE |
| 1     | SPKE |
| 2     | SNOW |
| 3     | SCIS |
| 4     | SCIT |
| 5     | OLGA |
| 6     | PFAN |
| 7     | JVDM |
| 8     | LEIT |
| 9     | LEIC |
| 10    | LEIS |
| 11    | MMAC |

| <b>Value</b> | <b>Name</b> |
|--------------|-------------|
| 12           | NOVS        |
| 13           | TPSH        |
| 14           | CONE        |
| 15           | TPSD        |
| 16           | TCWD        |
| 17           | UNAV        |
| 18           | TZGD        |
| 19           | CHCD        |
| 20           | JAVC        |
| 21           | LEIM        |
| 22           | NOVC        |
| 23           | ARFC        |
| 24           | HXCS        |
| 25           | JVGR        |
| 26           | STHC        |
| 27           | DUTD        |

## 2.16 BDSECUTOFF

### *Sets elevation cut-off angle for BeiDou satellites*

**Platform: OEM719, OEM729, OEM7500, OEM7700, OEM7720, PwrPak7, HxGN PIM7500**

This command is used to set the elevation cut-off angle for tracked BeiDou satellites. The receiver does not start automatically searching for a BeiDou satellite until it rises above the cut-off angle (when satellite position is known). Tracked satellites that fall below the cut-off angle are no longer tracked unless they are manually assigned (see the **ASSIGN** command on page 66).

In either case, satellites below the BDSECUTOFF angle are eliminated from the internal position and clock offset solution computations.

This command permits a negative cut-off angle; it could be used in these situations:

- The antenna is at a high altitude, and thus can look below the local horizon
- Satellites are visible below the horizon due to atmospheric refraction



Care must be taken when using **BDSECUTOFF** command because the signals from lower elevation satellites are traveling through more atmosphere and are therefore degraded. Use of satellites below 5 degrees is not recommended.



Use the **ELEVATIONCUTOFF** command on page 134 to set the cut-off angle for all other systems.



For dual antenna receivers, this command applies to both the primary and secondary antennas.

**Message ID: 1582**

**Abbreviated ASCII Syntax:**

```
BDSECUTOFF angle
```

**Factory Default:**

```
BDSECUTOFF 5.0
```

**ASCII Example:**

```
BDSECUTOFF 10.0
```

| Field | Field Type        | ASCII Value   | Binary Value | Description  | Format | Binary Bytes | Binary Offset |
|-------|-------------------|---------------|--------------|--|--------|--------------|---------------|
| 1     | BDSECUTOFF header | -             | -            | Command header. See <i>Messages</i> on page 25 for more information. | -      | H            | 0             |
| 2     | angle             | ±90.0 degrees |              | Elevation cut-off angle relative to horizon                          | Float  | 4            | H             |

## 2.17 BESTVELTYPE

**Sets the velocity used in the BESTVEL and GPVTG logs**

**Platform: OEM719, OEM729, OEM7500, OEM7700, OEM7720, PwrPak7, HxGN PIM7500**

This command configures the source of the velocity that is output in the BESTVEL and GPVTG logs. Set the type to something other than BESTPOS when an unchanging velocity source with specific characteristics is needed.

The Doppler velocity is the highest-availability, lowest-latency velocity available from the receiver. Due to its low latency, it is also the noisiest velocity.

**Message ID: 1678**

**Abbreviated ASCII Syntax:**

```
BESTVELTYPE mode
```

**Factory Default:**

```
BESTVELTYPE bestpos
```

**ASCII Example:**

```
BESTVELTYPE doppler
```

| Field | Field Type         | Description  | Format | Binary Bytes | Binary Offset |
|-------|--------------------|--|--------|--------------|---------------|
| 1     | BESTVELTYPE header | Command header. See <i>Messages</i> on page 25 for more information. | -      | H            | 0             |
| 2     | mode               | Velocity type (see <i>Table 21: Velocity Types</i> below)            | Enum   | 4            | H             |

**Table 21: Velocity Types**

| ASCII   | Binary | Description  |
|---------|--------|--|
| BESTPOS | 0      | Use the velocity from the same positioning filter that is being used to fill BESTPOS and GPGGA |
| DOPPLER | 1      | Always fill BESTVEL using Doppler-derived velocities   |

## 2.18 CANCONFIG

### Configure CAN ports

**Platform:** OEM719, OEM729, OEM7500, OEM7700, OEM7720, PwrPak7, HxGN PIM7500

Use the CANCONFIG command to configure the hardware parameters of the CAN ports.

**Message ID: 884**

#### Abbreviated ASCII Syntax:

```
CANCONFIG port switch [speed]
```

#### Factory Default:

```
CANCONFIG CAN1 OFF 250K
```

```
CANCONFIG CAN2 OFF 250K
```

#### ASCII Example:

```
CANCONFIG CAN1 OFF 500K
```

| Field | Field Type       | ASCII Value                               | Binary Value | Description  | Format | Binary Bytes | Binary Offset |
|-------|------------------|---|--------------|--|--------|--------------|---------------|
| 1     | CANCONFIG header | -   | -            | Command header. See <i>Messages</i> on page 25 for more information. | -      | H            | 0             |
| 2     | port             | CAN1                                      | 1            | Physical CAN port ID   | Enum   | 4            | H             |
|       |                  | CAN2                                      | 2            |  |        |              |               |
| 3     | switch           | ON  | 1            | Sets the port to be On or Off the CAN bus                            | Enum   | 4            | H+4           |
|       |                  | OFF                                       | 0            |  |        |              |               |
| 4     | speed            | See <i>Table 22: CAN Port Speed</i> below |              | Physical CAN port speed (bits per second) (default = 250K)           | Enum   | 4            | H+8           |



The CAN port must be set to OFF (using `CANCONFIG <port> OFF`) before the port speed can be changed.

**Table 22: CAN Port Speed**

| ASCII Value | Binary Value |
|-------------|--------------|
| 10K         | 0            |



| <b>ASCII Value</b> | <b>Binary Value</b> |
|--------------------|---------------------|
| 20K                | 1                   |
| 50K                | 2                   |
| 100K               | 3                   |
| 125K               | 4                   |
| 250K               | 5                   |
| 500K               | 6                   |
| 1M                 | 7                   |

## 2.19 CCOMCONFIG

### Configure the CAN COM port

**Platform: OEM719, OEM729, OEM7500, OEM7700, OEM7720, PwrPak7, HxGN PIM7500**

Bind a CAN communication port to a J1939 node (see **J1939CONFIG** command on page 212) and specify the CAN protocol, PGN, priority and address for messages transmitted and received over the CCOM port.

**Message ID: 1902**

#### Abbreviated ASCII Syntax:

```
CCOMCONFIG port node protocol [pgn [priority [address]]]
```

#### Factory Default:

```
CCOMCONFIG ccom1 node1 J1939 61184 7 fe
CCOMCONFIG ccom2 node2 J1939 61184 7 fe
CCOMCONFIG ccom3 node1 J1939 126720 7 fe
CCOMCONFIG ccom4 none none 0 0 0
CCOMCONFIG ccom5 none none 0 0 0
CCOMCONFIG ccom6 none none 0 0 0
```

#### ASCII Example :

```
ccomconfig ccom1 j1939 1792 6 1b
```

| Field | Field Type        | ASCII Value | Binary Value | Description  | Format | Binary Bytes | Binary Offset |
|-------|-------------------|-------------|--------------|--|--------|--------------|---------------|
| 1     | CCOMCONFIG Header | -           | -            | Command header. See <i>Messages</i> on page 25 for more information. | -      | H            | 0             |
| 2     | port              | CCOM1       | 38           | Name of CCOM port  | Enum   | 4            | H             |
|       |                   | CCOM2       | 39           |  |        |              |               |
|       |                   | CCOM3       | 40           |  |        |              |               |
|       |                   | CCOM4       | 41           |  |        |              |               |
|       |                   | CCOM5       | 42           |  |        |              |               |
|       |                   | CCOM6       | 43           |  |        |              |               |

| Field | Field Type | ASCII Value  | Binary Value | Description  | Format | Binary Bytes | Binary Offset |
|-------|------------|--|--------------|--|--------|--------------|---------------|
| 3     | node       | NODE1  | 1            | The J1939 node to use. This binds a CCOM port to the CAN NAME/address associated with the node.  | Enum   | 4            | H+4           |
|       |            | NODE2  | 2            |  |        |              |               |
| 4     | protocol   | See <i>Table 23: CAN Protocol</i> on the next page |              | CAN transport protocol to use  | Enum   | 4            | H+8           |
| 5     | pgn        | 0 - 131071   |              | Any valid PGN as defined by the J1939 protocol.<br>All messages transmitted over this CCOM port will contain this PGN value.<br>Only messages with this PGN will be received on this CCOM port<br><b>Note:</b> This value is ignored if the protocol is NMEA2000.  | Ulong  | 4            | H+12          |
| 6     | priority   | 0-7  |              | Default CAN message priority for transmitted messages. (Priority 0 is the highest priority)<br><b>Note:</b> This value is ignored if the protocol is NMEA2000.   | Uchar  | 1            | H+16          |
| 7     | address    | 00 - FF  |              | <b>00 – FD:</b><br>Transmit and receive messages to/from this address only<br><b>FE:</b><br>Transmit and receive message to/from the address of the first message received<br><b>FF:</b><br>Broadcast messages and receive messages from all addresses.<br><b>Note:</b> This value is ignored if the protocol is NMEA2000. | Hex    | 1            | H+17          |

**Table 23: CAN Protocol**

| <b>Binary</b> | <b>ASCII</b> | <b>Description</b>                                  |
|---------------|--------------|---|
| 2             | J1939        | J1939 single packet                                 |
| 3             | NMEA2000     | NMEA2000 (single packet, multi-packet, fast packet) |
| 5             | ISO11783     | ISO 11783 transport protocol                        |

## 2.20 CLOCKADJUST

### *Enables clock adjustments*

**Platform: OEM719, OEM729, OEM7500, OEM7700, OEM7720, PwrPak7, HxGN PIM7500**

All oscillators have some inherent drift. By default, the receiver attempts to steer the receiver's clock to accurately match GPS reference time. Use the **CLOCKADJUST** command to disable this function. The **TIME** log can then be used to monitor clock drift.



1. The **CLOCKADJUST** command should only be used by advanced users.
2. If the **CLOCKADJUST** command is **ENABLED** and the receiver is configured to use an external reference frequency (set in the **EXTERNALCLOCK** command (see page 144) for an external clock - TCXO, OCXO, RUBIDIUM, CESIUM, or USER), then the clock steering process takes over the VARF output pins and may conflict with a previously entered **FREQUENCYOUT** command (see page 167).
3. When using the **EXTERNALCLOCK** and **CLOCKADJUST** commands together, issue the **EXTERNALCLOCK** command (see page 144) first to avoid losing satellites.
4. When disabled, the range measurement bias errors continue to accumulate with clock drift.
5. Pseudorange, carrier phase and Doppler measurements may jump if the **CLOCKADJUST** mode is altered while the receiver is tracking.
6. When disabled, the time reported on all logs may be offset from GPS reference time. The 1PPS output may also be offset. The amount of this offset may be determined from the **TIME** log (see page 822).
7. A discussion on GPS reference time may be found in *GPS Reference Time Status* on page 47.

**Message ID: 15**

**Abbreviated ASCII Syntax:**

```
CLOCKADJUST switch
```

**Factory Default:**

```
CLOCKADJUST ENABLE
```

**ASCII Example:**

```
CLOCKADJUST DISABLE
```



The **CLOCKADJUST** command can be used to calibrate an internal oscillator. Disable the **CLOCKADJUST** mode in order to find out what the actual drift is from the internal oscillator. Watch the **CLOCKMODEL** log to see the drift rate and adjust the oscillator until the drift stops.

| Field | Field Type         | ASCII Value | Binary Value | Description  | Format | Binary Bytes | Binary Offset |
|-------|--------------------|-------------|--------------|--|--------|--------------|---------------|
| 1     | CLOCKADJUST header | -           | -            | Command header. See <i>Messages</i> on page 25 for more information. | -      | H            | 0             |
| 2     | switch             | DISABLE     | 0            | Disallow adjustment of internal clock                                | Enum   | 4            | H             |
|       |                    | ENABLE      | 1            | Allow adjustment of internal clock                                   |        |              |               |

## 2.21 CLOCKCALIBRATE

### *Adjusts clock steering parameters*

**Platform: OEM719, OEM729, OEM7500, OEM7700, OEM7720, PwrPak7, HxGN PIM7500**

This command is used to adjust the control parameters of the clock steering loop. The receiver must be enabled for clock steering before these values can take effect. Refer to the **CLOCKADJUST** command on page 101 to enable or disable clock steering.

To disable the clock steering process, issue the **CLOCKADJUST DISABLE** command.

The current values used by the clock steering process are listed in the **CLOCKSTEERING** command (see page 447).



The values entered using the **CLOCKCALIBRATE** command are saved to non-volatile memory (NVM). To restore the values to their defaults, the **FRESET CLKCALIBRATION** command must be used. Issuing FRESET without the CLKCALIBRATION parameter will not clear the values (see **FRESET** command on page 170 for more details).

**Message ID: 430**

#### **Abbreviated ASCII Syntax:**

```
CLOCKCALIBRATE [mode] [period] [pulsewidth] [slope] [bandwidth]
```

#### **ASCII Example:**

```
CLOCKCALIBRATE AUTO
```



The receiver by default steers its INTERNAL VCTCXO but can be commanded to control an EXTERNAL reference oscillator. Use the **EXTERNALCLOCK** command (see page 144) to configure the receiver to use an external reference oscillator. If the receiver is configured for an external reference oscillator and configured to adjust its clock, then the clock steering loop attempts to steer the external reference oscillator through the use of the VARF signal. Note that the clock steering control process conflicts with the manual **FREQUENCYOUT** command (see page 167). It is expected that the VARF signal is used to provide a stable reference voltage by the use of a filtered charge pump type circuit (not supplied).

| Field | Field Type             | ASCII Value | Binary Value | Description  | Format | Binary Bytes | Binary Offset |
|-------|------------------------|-------------|--------------|--|--------|--------------|---------------|
| 1     | CLOCK CALIBRATE header | -           | -            | Command header. See <i>Messages</i> on page 25 for more information. | -      | H            | 0             |

| Field | Field Type | ASCII Value  | Binary Value | Description   | Format | Binary Bytes | Binary Offset |
|-------|------------|--|--------------|---|--------|--------------|---------------|
| 2     | mode       | SET  | 0            | Sets the period, pulsewidth, slope and bandwidth values into NVM for the currently selected steered oscillator (INTERNAL or EXTERNAL)   | Enum   | 4            | H             |
|       |            | AUTO   | 1            | Forces the receiver to do a clock steering calibration to measure the slope (change in clock drift rate with a 1 bit change in pulse width) and required pulsewidth to zero the clock drift rate. After the calibration, these values along with the period and bandwidth are entered into NVM and are then used from this point forward on the selected oscillator       |        |              |               |
|       |            | OFF  | 2            | Terminates a calibration process currently underway (default)   |        |              |               |
| 3     | period     | 0 to 262144  |              | Signal period in 10 ns steps.<br>Frequency Output =<br>100,000,000 / Period<br>(default=11000)  | Ulong  | 4            | H+4           |
| 4     | pulsewidth | The valid range for this parameter is 10% to 90% of the period |              | Sets the initial pulse width that should provide a near zero drift rate from the selected oscillator being steered. The valid range for this parameter is 10% to 90% of the period. If this value is not known, (in the case of a new external oscillator) then it should be set to ½ the period and the mode should be set to AUTO to force a calibration (default=6600) | Ulong  | 4            | H+8           |



| Field | Field Type | ASCII Value | Binary Value | Description   | Format | Binary Bytes | Binary Offset |
|-------|------------|-------------|--------------|---|--------|--------------|---------------|
| 5     | slope      |             |              | This value should correspond to how much the clock drift changes with a 1 bit change in the pulsewidth m/s/bit. The default values for the slope used for the INTERNAL and EXTERNAL clocks is -2.0 and -0.01 respectively. If this value is not known, then its value should be set to 1.0 and the mode should be set to AUTO to force a calibration. Once the calibration process is complete and using a slope value of 1.0, the receiver should be recalibrated using the measured slope and pulsewidth values (see the <b>CLOCKSTEERING</b> log on page 447). This process should be repeated until the measured slope value remains constant (less than a 5% change) (default=0.774) | Float  | 4            | H+12          |
| 6     | bandwidth  |             |              | This is the value used to control the smoothness of the clock steering process. Smaller values result in slower and smoother changes to the receiver clock. Larger values result in faster responses to changes in oscillator frequency and faster start up clock pull in. The default values are 0.03 and 0.001 Hz respectively for the INTERNAL and EXTERNAL clocks (default=0.03)  | Float  | 4            | H+16          |

## 2.22 CLOCKOFFSET

### *Adjusts for delay in 1PPS output*

**Platform: OEM719, OEM729, OEM7500, OEM7700, OEM7720, PwrPak7, HxGN PIM7500**

This command is used to remove a delay in the PPS output. The PPS signal is delayed from the actual measurement time due to two major factors:

- A delay in the signal path from the antenna to the receiver
- An intrinsic delay through the RF and digital sections of the receiver

The second delay is automatically accounted for by the receiver using a nominal value determined for each receiver type. However, since the delay from the antenna to the receiver cannot be determined by the receiver, an adjustment cannot automatically be made. The **CLOCKOFFSET** command can be used to adjust for this delay.

**Message ID: 596**

#### Abbreviated ASCII Syntax:

```
CLOCKOFFSET offset
```

#### Factory Default:

```
CLOCKOFFSET 0
```

#### ASCII Example:

```
CLOCKOFFSET -15
```



There may be small variances in the delays for each cable or card. The **CLOCKOFFSET** command can be used to characterize each setup. For example, for a cable with a delay of 10 ns, the offset can be set to -10 to remove the delay from the PPS output.

| Field | Field Type         | ASCII Value | Binary Value | Description  | Format | Binary Bytes | Binary Offset |
|-------|--------------------|-------------|--------------|--|--------|--------------|---------------|
| 1     | CLOCKOFFSET header | -           | -            | Command header. See <i>Messages</i> on page 25 for more information. | -      | H            | 0             |
| 2     | offset             | ±200        |              | Specifies the offset in nanoseconds                                  | Long   | 4            | H             |

## 2.23 CNOUPDATE

### *Sets the C/No update rate*

**Platform:** OEM719, OEM729, OEM7500, OEM7700, OEM7720, PwrPak7, HxGN PIM7500

This command is used to set the C/No update rate.

**Message ID:** 849

**Abbreviated ASCII Syntax:**

```
CNOUPDATE rate
```

**Factory Default:**

```
CNOUPDATE default
```

**ASCII Example (rover):**

```
CNOUPDATE 20Hz
```



Use the **CNOUPDATE** command for higher resolution update rate of the C/No measurements of the incoming GNSS signals. By default, the C/No values are calculated at approximately 4 Hz but this command allows you to increase that rate to 20 Hz.

| Field | Field Type       | ASCII Value | Binary Value | Description   | Format | Binary Bytes | Binary Offset |
|-------|------------------|-------------|--------------|---|--------|--------------|---------------|
| 1     | CNOUPDATE header | -           | -            | Command header. See <i>Messages</i> on page 25 for more information.                        | -      | H            | 0             |
| 2     | rate             | DEFAULT     | 0            | C/No update rate:<br>0 = Turn off C/No enhancement default = 4 Hz<br>1 = 20 Hz C/No updates | Enum   | 4            | H             |
|       |                  | 20HZ        | 1            |   |        |              |               |

## 2.24 COMCONTROL

### *Controls the serial port hardware control lines*

**Platform: OEM719, OEM729, OEM7500, OEM7700, OEM7720, PwrPak7, HxGN PIM7500**

This command is used to control the hardware control lines of the serial communication (COM) ports. The TOGGLEPPS mode of this command is typically used to supply a timing signal to a host PC computer by using the RTS and DTR lines. The accuracy of controlling the COM control signals is better than 900  $\mu$ s. The other modes are typically used to control custom peripheral devices.



1. If handshaking is disabled, any of these modes can be used without affecting regular serial communications through the selected COM port. However, if handshaking is enabled, it may conflict with handshaking of the selected COM port, causing unexpected results.
2. The PULSEPPSLOW control type cannot be issued for a TX signal.
3. Only PULSEPPSHIGH, FORCEHIGH and FORCELOW control types can be used for a TX signal.

#### **Message ID: 431**

#### **Abbreviated ASCII Syntax:**

```
COMCONTROL [port] [signal] [control]
```

#### **Factory Default:**

```
COMCONTROL COM1 RTS DEFAULT
COMCONTROL COM2 RTS DEFAULT
COMCONTROL COM3 RTS DEFAULT
COMCONTROL COM4 RTS DEFAULT
COMCONTROL COM5 RTS DEFAULT
```

#### **ASCII Example 1:**

```
SERIALCONFIG COM1 9600 N 8 1 N (to disable handshaking)
COMCONTROL COM1 RTS FORCELOW
```

#### **ASCII Example 2:**

```
COMCONTROL COM1 RTS TOGGLEPPS
COMCONTROL COM2 RTS TOGGLEPPS
COMCONTROL COM3 RTS TOGGLEPPS
```

#### **ASCII Example 3:**

To set a break condition on COM1:

```
COMCONTROL COM1 TX FORCELOW
```

A break condition remains in effect until it is cleared. To clear a break condition on COM1:

```
COMCONTROL COM1 TX DEFAULT
```

or

COMCONTROL COM1 TX FORCEHIGH

| Field | Field Type         | ASCII Value | Binary Value | Description   | Format | Binary Bytes | Binary Offset |
|-------|--------------------|-------------|--------------|---|--------|--------------|---------------|
| 1     | COM CONTROL header | -           | -            | Command header. See <i>Messages</i> on page 25 for more information.  | -      | H            | 0             |
| 2     | port               | COM1        | 1            | Serial port to control.   | Enum   | 4            | H             |
|       |                    | COM2        | 2            |   |        |              |               |
|       |                    | COM3        | 3            |   |        |              |               |
|       |                    | COM4        | 19           |   |        |              |               |
|       |                    | COM5        | 31           |   |        |              |               |
| 3     | signal             | RTS         | 0            | COM signal to control. The controllable COM signals are RTS, DTR and TX. (Default = RTS)<br><br>See also <i>Table 24: Tx, DTR and RTS Availability</i> on the next page | Enum   | 4            | H+4           |
|       |                    | DTR         | 1            |   |        |              |               |
|       |                    | TX          | 2            |   |        |              |               |

| Field | Field Type | ASCII Value  | Binary Value | Description   | Format | Binary Bytes | Binary Offset |
|-------|------------|--------------|--------------|---|--------|--------------|---------------|
| 4     | control    | DEFAULT      | 0            | Disables this command and returns the COM signal to its default state (Default)   | Enum   | 4            | H+8           |
|       |            | FORCEHIGH    | 1            | Immediately forces the signal high  |        |              |               |
|       |            | FORCELOW     | 2            | Immediately forces the signal low   |        |              |               |
|       |            | TOGGLE       | 3            | Immediately toggles the current state of the signal   |        |              |               |
|       |            | TOGGLEPPS    | 4            | Toggles the state of the selected signal within 900 $\mu$ s after each 1PPS event. The state change of the signal lags the 1PPS by an average value of 450 $\mu$ s. The delay of each pulse varies by a uniformly random amount less than 900 $\mu$ s |        |              |               |
|       |            | PULSEPPSLOW  | 5            | Pulses the line low at a 1PPS event and to high 1 ms after it. Not for TX   |        |              |               |
|       |            | PULSEPPSHIGH | 6            | Pulses the line high for 1 ms at the time of a 1PPS event   |        |              |               |

**Table 24: Tx, DTR and RTS Availability**

|                | Tx Available On              | DTR Available On | RTS Available On |
|----------------|------------------------------|------------------|------------------|
| <b>OEM719</b>  | COM1, COM2, COM3             | N/A              | N/A              |
| <b>OEM729</b>  | COM1, COM2, COM3             | N/A              | COM1 and COM2    |
| <b>OEM7700</b> | COM1, COM2, COM3, COM4, COM5 | N/A              | COM2             |
| <b>OEM7720</b> | COM1, COM2, COM3, COM4, COM5 | N/A              | COM2             |

## 2.25 DATADECODESIGNAL

### *Enable/Disable navigation data decoding for GNSS signal*

**Platform: OEM719, OEM729, OEM7500, OEM7700, OEM7720, PwrPak7, HxGN PIM7500**

Use this command to enable or disable decoding of the navigation message for each GNSS signal. The default setting for each GNSS signal, and which signals can be configured, is available in *Table 25: GNSS Signal Default and Configurability* below. The table also lists if the signal's navigation message is used to compute the satellite position. For the binary value and a longer description for each signal, see *Table 29: Signal Type* on page 124.

**Table 25: GNSS Signal Default and Configurability**

| Signal    | Default  | Configurable | Used for satellite positioning |
|-----------|----------|--------------|--------------------------------|
| GPSL1C    | Disabled | No           | No                             |
| GPSL1CA   | Enabled  | Yes          | Yes                            |
| GPSL2Y    | Disabled | No           | No                             |
| GPSL2C    | Disabled | Yes          | No                             |
| GPSL2P    | Disabled | No           | No                             |
| GPSL5     | Disabled | Yes          | No                             |
| GLOL1CA   | Enabled  | Yes          | Yes                            |
| GLOL2CA   | Disabled | No           | No                             |
| GLOL2P    | Disabled | No           | No                             |
| SBASL1    | Enabled  | Yes          | Yes                            |
| SBASL5    | Disabled | No           | Yes                            |
| GALE1     | Enabled  | Yes          | Yes                            |
| GALE5A    | Enabled  | Yes          | Yes                            |
| GALE5B    | Enabled  | Yes          | Yes                            |
| GALALTBOC | Disabled | No           | No                             |
| BDSB1D1   | Enabled  | Yes          | Yes                            |
| BDSB1D2   | Enabled  | Yes          | Yes                            |
| BDSB2D1   | Disabled | No           | No                             |
| BDSB2D2   | Disabled | No           | No                             |
| BDSB3D1   | Disabled | No           | No                             |

| Signal     | Default  | Configurable | Used for satellite positioning |
|------------|----------|--------------|--------------------------------|
| BDSB3D2    | Disabled | No           | No                             |
| QZSSL1C    | Disabled | No           | No                             |
| QZSSL1CA   | Enabled  | Yes          | Yes                            |
| QZSSL2C    | Disabled | Yes          | No                             |
| QZSSL5     | Disabled | Yes          | No                             |
| QZSSL6     | Disabled | No           | No                             |
| NAVICL5SPS | Enabled  | Yes          | Yes                            |

**Message ID: 1532****Abbreviated ASCII Syntax:**

```
DATADECODESIGNAL signaltype switch
```

**Abbreviated ASCII Example:**

```
DATADECODESIGNAL GPSL2C enable
```

| Field | Field Type               | ASCII Value   | Binary Value | Description  | Format | Binary Bytes | Binary Offset |
|-------|--------------------------|---|--------------|--|--------|--------------|---------------|
| 1     | DATADECODE SIGNAL header | -   | -            | Command header. See <i>Messages</i> on page 25 for more information. | -      | H            | 0             |
| 2     | signal type              | See Table 26: <i>Signal Type (DATADECODESIGNAL)</i> below |              | GNSS Signal Type   | Enum   | 4            | H             |
| 3     | switch                   | Disable   | 0            | Enable or disable the data decoding                                  | Enum   | 4            | H+4           |
|       |                          | Enable  | 1            |  |        |              |               |

**Table 26: Signal Type (DATADECODESIGNAL)**

| Value (Binary) | Signal (ASCII) | Description     |
|----------------|----------------|-----------------|
| 33             | GPSL1CA        | GPS L1 C/A-code |
| 69             | GPSL2C         | GPS L2 C/A-code |



| <b>Value (Binary)</b> | <b>Signal (ASCII)</b> | <b>Description</b>                |
|-----------------------|-----------------------|-----------------------------------|
| 70                    | GPSL2P                | GPS L2 P-code                     |
| 103                   | GPSL5                 | GPS L5                            |
| 2177                  | GLOL1CA               | GLONASS L1 C/A-code               |
| 2211                  | GLOL2CA               | GLONASS L2 C/A-code               |
| 2212                  | GLOL2P                | GLONASS L2 P-code                 |
| 4129                  | SBASL1                | SBAS L1                           |
| 4194                  | SBASL5                | SBAS L5                           |
| 16737                 | LBAND                 | LBAND                             |
| 10433                 | GALE1                 | Galileo E1                        |
| 10466                 | GALE5A                | Galileo E5A                       |
| 10499                 | GALE5B                | Galileo E5B                       |
| 12673                 | BDSB1D1               | BeiDou B1 with D1 navigation data |
| 12674                 | BDSB1D2               | BeiDou B1 with D2 navigation data |
| 12803                 | BDSB2D1               | BeiDou B2 with D1 navigation data |
| 12804                 | BDSB2D2               | BeiDou B2 with D2 navigation data |
| 12877                 | BDSB3D1               | BeiDou B3 with D1 navigation data |
| 12880                 | BDSB3D2               | BeiDou B3 with D2 navigation data |
| 14753                 | QZSSL1CA              | QZSS L1 C/A-code                  |
| 14787                 | QZSSL2C               | QZSS L2 C/A-code                  |
| 14820                 | QZSSL5                | QZSS L5                           |
| 19073                 | NAVICL5SPS            | NavIC L5 SPS                      |

## 2.26 DATUM

### *Chooses a datum name type*

**Platform: OEM719, OEM729, OEM7500, OEM7700, OEM7720, PwrPak7, HxGN PIM7500**

This command is used to select the geodetic datum for operation of the receiver. If not set, the factory default value is wgs84. See the **USERDATUM** command (see page 380) for user definable datums. The datum you select causes all position solutions to be based on that datum.

The transformation for the WGS84 to Local used in the OEM7 family is the Bursa-Wolf transformation or reverse Helmert transformation. In the Helmert transformation, the rotation of a point is counter clockwise around the axes. In the Bursa-Wolf transformation, the rotation of a point is clockwise. Therefore, the reverse Helmert transformation is the same as the Bursa-Wolf.

See *Table 28: Datum Transformation Parameters* on page 116 for a complete listing of all available predefined datums. The offsets in the table are from the local datum to WGS84.

**Message ID: 160**

#### **Abbreviated ASCII Syntax:**

```
DATUM datum
```

#### **Factory Default:**

```
DATUM wgs84
```

#### **ASCII Example:**

```
DATUM CSRS
```

Also, as an example, you can achieve spatial integrity with Government of Canada maps and surveys if the coordinates are output using the CSRS datum (Datum ID# 64).

*Table 27: Reference Ellipsoid Constants* on the next page contains the internal ellipsoid and transformation parameters used in the receiver. The values contained in these tables were derived from the following dma reports:

- 1 TR 8350.2 Department of Defense World Geodetic System 1984 and Relationships with Local Geodetic Systems - Revised March 1, 1988
- 2 TR 8350.2B Supplement to Department of Defense World Geodetic System 1984 Technical Report - Part II - Parameters, Formulas, and Graphics for the Practical Application of WGS84 - December 1, 1987
- 3 TR 8350.2 Department of Defense World Geodetic System 1984 National Imagery and Mapping Agency Technical Report, Third Addition, Amendment 1 - January 3, 2000



By default, NovAtel receivers output positions in WGS84, with the following exceptions: EGNOS, TerraStar and Veripos use ITRF2008, which is coincident with WGS84 at about the decimetre level.

| Field | Field Type   | ASCII Value   | Binary Value | Description  | Format | Binary Bytes | Binary Offset |
|-------|--------------|---|--------------|--|--------|--------------|---------------|
| 1     | DATUM header | -   | -            | Command header. See <i>Messages</i> on page 25 for more information. | -      | H            | 0             |
| 2     | Datum Type   | See <i>Table 28: Datum Transformation Parameters</i> on the next page |              | The datum to use   | Enum   | 4            | H             |

**Table 27: Reference Ellipsoid Constants**

| ELLIPSOID                        | ID CODE  | a (metres)  | 1/f           | f                |
|----------------------------------|----------|-------------|---------------|------------------|
| Airy 1830                        | AW       | 6377563.396 | 299.3249646   | 0.00334085064038 |
| Modified Airy                    | AM       | 6377340.189 | 299.3249646   | 0.00334085064038 |
| Australian National              | AN       | 6378160.0   | 298.25        | 0.00335289186924 |
| Bessel 1841                      | BR       | 6377397.155 | 299.1528128   | 0.00334277318217 |
| Clarke 1866                      | CC       | 6378206.4   | 294.9786982   | 0.00339007530409 |
| Clarke 1880                      | CD       | 6378249.145 | 293.465       | 0.00340756137870 |
| Everest (India 1830)             | EA       | 6377276.345 | 300.8017      | 0.00332444929666 |
| Everest (Brunei & E.Malaysia)    | EB       | 6377298.556 | 300.8017      | 0.00332444929666 |
| Everest (W.Malaysia & Singapore) | EE       | 6377304.063 | 300.8017      | 0.00332444929666 |
| Geodetic Reference System 1980   | RF       | 6378137.0   | 298.257222101 | 0.00335281068118 |
| Helmert 1906                     | HE       | 6378200.0   | 298.30        | 0.00335232986926 |
| Hough 1960                       | HO       | 6378270.0   | 297.00        | 0.00336700336700 |
| International 1924               | IN       | 6378388.0   | 297.00        | 0.00336700336700 |
| Parameters of the Earth          | PZ-90.02 | 6378136.0   | 298.26        | 0.00335280374302 |
| South American 1969              | SA       | 6378160.0   | 298.25        | 0.00335289186924 |
| World Geodetic System 1972       | WD       | 6378135.0   | 298.26        | 0.00335277945417 |
| World Geodetic System 1984       | WE       | 6378137.0   | 298.257223563 | 0.00335281066475 |



The default user datum is WGS84.

See also the **USERDATUM** command (see page 380) and **USEREXPDATUM** command (see page 382).

The following logs report the datum used according to the Datum ID column:

- **BESTPOS** log (see page 416)
- **BESTUTM** log (see page 429)
- **MATCHEDPOS** log (see page 576)
- **PSRPOS** log (see page 634)

**Table 28: Datum Transformation Parameters**

| Datum ID# | NAME  | DX   | DY <sup>1</sup> | DZ <sup>1</sup> | DATUM DESCRIPTION                                    | ELLIPSOID           |
|-----------|-------|------|-----------------|-----------------|--|---------------------|
| 1         | ADIND | -162 | -12             | 206             | This datum has been updated, see ID# 65 <sup>2</sup> | Clarke 1880         |
| 2         | ARC50 | -143 | -90             | -294            | ARC 1950 (SW & SE Africa)                            | Clarke 1880         |
| 3         | ARC60 | -160 | -8              | -300            | This datum has been updated, see ID# 66 <sup>2</sup> | Clarke 1880         |
| 4         | AGD66 | -133 | -48             | 148             | Australian Geodetic Datum 1966                       | Australian National |
| 5         | AGD84 | -134 | -48             | 149             | Australian Geodetic Datum 1984                       | Australian National |
| 6         | BUKIT | -384 | 664             | -48             | Bukit Rimpah (Indonesia)                             | Bessel 1841         |
| 7         | ASTRO | -104 | -129            | 239             | Camp Area Astro (Antarctica)                         | International 1924  |
| 8         | CHATM | 175  | -38             | 113             | Chatham 1971 (New Zealand)                           | International 1924  |
| 9         | CARTH | -263 | 6               | 431             | Carthage (Tunisia)                                   | Clarke 1880         |
| 10        | CAPE  | -136 | -108            | -292            | CAPE (South Africa)                                  | Clarke 1880         |
| 11        | DJAKA | -377 | 681             | -50             | Djakarta (Indonesia)                                 | Bessel 1841         |
| 12        | EGYPT | -130 | 110             | -13             | Old Egyptian   | Helmert 1906        |

<sup>1</sup>The DX, DY and DZ offsets are from your local datum to WGS84.

<sup>2</sup>The updated datum have the new x, y and z translation values updated to the latest numbers. The old datum values can still be used for backwards compatibility.

| Datum ID# | NAME   | DX   | DY <sup>1</sup> | DZ <sup>1</sup> | DATUM DESCRIPTION  | ELLIPSOID          |
|-----------|--------|------|-----------------|-----------------|--|--------------------|
| 13        | ED50   | -87  | -98             | -121            | European 1950  | International 1924 |
| 14        | ED79   | -86  | -98             | -119            | European 1979  | International 1924 |
| 15        | GUNSG  | -403 | 684             | 41              | G. Segara (Kalimantan - Indonesia)                           | Bessel 1841        |
| 16        | GEO49  | 84   | -22             | 209             | Geodetic Datum 1949 (New Zealand)                            | International 1924 |
| 17        | GRB36  | 375  | -111            | 431             | <b>Do not use.</b> Use ID# 76 instead <sup>2</sup>           | Airy 1830          |
| 18        | GUAM   | -100 | -248            | 259             | Guam 1963 (Guam Island)                                      | Clarke 1866        |
| 19        | HAWAII | 89   | -279            | -183            | <b>Do not use.</b> Use ID# 77 or ID# 81 instead <sup>3</sup> | Clarke 1866        |
| 20        | KAUAI  | 45   | -290            | -172            | <b>Do not use.</b> Use ID# 78 or ID# 82 instead <sup>3</sup> | Clarke 1866        |
| 21        | MAUI   | 65   | -290            | -190            | <b>Do not use.</b> Use ID# 79 or ID# 83 instead <sup>3</sup> | Clarke 1866        |
| 22        | OAHU   | 56   | -284            | -181            | <b>Do not use.</b> Use ID# 80 or ID# 84 instead <sup>3</sup> | Clarke 1866        |
| 23        | HERAT  | -333 | -222            | 114             | Herat North (Afghanistan)                                    | International 1924 |
| 24        | HJORS  | -73  | 46              | -86             | Hjorsey 1955 (Iceland)                                       | International 1924 |
| 25        | HONGK  | -156 | -271            | -189            | Hong Kong 1963   | International 1924 |
| 26        | HUTZU  | -634 | -549            | -201            | This datum has been updated, see ID# 68 <sup>2</sup>         | International 1924 |
| 27        | INDIA  | 289  | 734             | 257             | <b>Do not use.</b> Use ID# 69 or ID# 70 instead <sup>3</sup> | Everest (EA)       |
| 28        | IRE65  | 506  | -122            | 611             | <b>Do not use.</b> Use ID# 71 instead <sup>3</sup>           | Modified Airy      |
| 29        | KERTA  | -11  | 851             | 5               | Kertau 1948 (West Malaysia and Singapore)                    | Everest (EE)       |

<sup>1</sup>The DX, DY and DZ offsets are from your local datum to WGS84.

<sup>2</sup>Use the corrected datum only (with the higher ID#) as the old datum is incorrect.

| Datum ID# | NAME   | DX   | DY <sup>1</sup> | DZ <sup>1</sup> | DATUM DESCRIPTION                                    | ELLIPSOID          |
|-----------|--------|------|-----------------|-----------------|--|--------------------|
| 30        | KANDA  | -97  | 787             | 86              | Kandawala (Sri Lanka)                                | Everest (EA)       |
| 31        | LIBER  | -90  | 40              | 88              | Liberia 1964   | Clarke 1880        |
| 32        | LUZON  | -133 | -77             | -51             | <b>Do not use.</b> Use ID# 72 instead <sup>3</sup>   | Clarke 1866        |
| 33        | MINDA  | -133 | -70             | -72             | This datum has been updated, see ID# 73 <sup>2</sup> | Clarke 1866        |
| 34        | MERCH  | 31   | 146             | 47              | Merchich (Morocco)                                   | Clarke 1880        |
| 35        | NAHR   | -231 | -196            | 482             | This datum has been updated, see ID# 74 <sup>2</sup> | Clarke 1880        |
| 36        | NAD83  | 0    | 0               | 0               | N. American 1983 (Includes Areas 37-42)              | GRS-80             |
| 37        | CANADA | -10  | 158             | 187             | N. American Canada 1927                              | Clarke 1866        |
| 38        | ALASKA | -5   | 135             | 172             | N. American Alaska 1927                              | Clarke 1866        |
| 39        | NAD27  | -8   | 160             | 176             | N. American Conus 1927                               | Clarke 1866        |
| 40        | CARIBB | -7   | 152             | 178             | This datum has been updated, see ID# 75 <sup>2</sup> | Clarke 1866        |
| 41        | MEXICO | -12  | 130             | 190             | N. American Mexico                                   | Clarke 1866        |
| 42        | CAMER  | 0    | 125             | 194             | N. American Central America                          | Clarke 1866        |
| 43        | MINNA  | -92  | -93             | 122             | Nigeria (Minna)                                      | Clarke 1880        |
| 44        | OMAN   | -346 | -1              | 224             | Oman   | Clarke 1880        |
| 45        | PUERTO | 11   | 72              | -101            | Puerto Rica and Virgin Islands                       | Clarke 1866        |
| 46        | QORNO  | 164  | 138             | -189            | Qornoq (South Greenland)                             | International 1924 |
| 47        | ROME   | -255 | -65             | 9               | Rome 1940 Sardinia Island                            | International 1924 |
| 48        | CHUA   | -134 | 229             | -29             | South American Chua Astro (Paraguay)                 | International 1924 |
| 49        | SAM56  | -288 | 175             | -376            | South American (Provisional 1956)                    | International 1924 |

<sup>1</sup>The DX, DY and DZ offsets are from your local datum to WGS84.

| <b>Datum ID#</b> | <b>NAME</b> | <b>DX</b>                                | <b>DY<sup>1</sup></b> | <b>DZ<sup>1</sup></b> | <b>DATUM DESCRIPTION</b>                               | <b>ELLIPSOID</b>   |
|------------------|-------------|--|-----------------------|-----------------------|--|--------------------|
| 50               | SAM69       | -57                                      | 1                     | -41                   | South American 1969                                    | S. American 1969   |
| 51               | CAMPO       | -148                                     | 136                   | 90                    | S. American Campo Inchauspe (Argentina)                | International 1924 |
| 52               | SACOR       | -206                                     | 172                   | -6                    | South American Corrego Alegre (Brazil)                 | International 1924 |
| 53               | YACAR       | -155                                     | 171                   | 37                    | South American Yacare (Uruguay)                        | International 1924 |
| 54               | TANAN       | -189                                     | -242                  | -91                   | Tananarive Observatory 1925 (Madagascar)               | International 1924 |
| 55               | TIMBA       | -689                                     | 691                   | -46                   | This datum has been updated, see ID# 85 <sup>2</sup>   | Everest (EB)       |
| 56               | TOKYO       | -128                                     | 481                   | 664                   | This datum has been updated, see ID# 86 <sup>2</sup>   | Bessel 1841        |
| 57               | TRIST       | -632                                     | 438                   | -609                  | Tristan Astro 1968 (Tristan du Cunha)                  | International 1924 |
| 58               | VITI        | 51                                       | 391                   | -36                   | Viti Levu 1916 (Fiji Islands)                          | Clarke 1880        |
| 59               | WAK60       | 101                                      | 52                    | -39                   | This datum has been updated, see ID# 67 <sup>2</sup>   | Hough 1960         |
| 60               | WGS72       | 0  | 0                     | 4.5                   | World Geodetic System - 72                             | WGS72              |
| 61               | WGS84       | 0  | 0                     | 0                     | World Geodetic System - 84                             | WGS84              |
| 62               | ZANDE       | -265                                     | 120                   | -358                  | Zanderidj (Surinam)                                    | International 1924 |
| 63               | USER        | 0  | 0                     | 0                     | User Defined Datum Defaults                            | User               |
| 64               | CSRS        | Time-variable 7 parameter transformation |                       |                       |  |                    |
| 65               | ADIM        | -166                                     | -15                   | 204                   | Adindan (Ethiopia, Mali, Senegal & Sudan) <sup>2</sup> | Clarke 1880        |
| 66               | ARSM        | -160                                     | -6                    | -302                  | ARC 1960 (Kenya, Tanzania) <sup>2</sup>                | Clarke 1880        |
| 67               | ENW         | 102                                      | 52                    | -38                   | Wake-Eniwetok (Marshall Islands) <sup>2</sup>          | Hough 1960         |

<sup>1</sup>The DX, DY and DZ offsets are from your local datum to WGS84.

| <b>Datum ID#</b> | <b>NAME</b> | <b>DX</b> | <b>DY<sup>1</sup></b> | <b>DZ<sup>1</sup></b> | <b>DATUM DESCRIPTION</b>                                   | <b>ELLIPSOID</b>   |
|------------------|-------------|-----------|-----------------------|-----------------------|--|--------------------|
| 68               | HTN         | -637      | -549                  | -203                  | Hu-Tzu-Shan (Taiwan) <sup>2</sup>                          | International 1924 |
| 69               | INDB        | 282       | 726                   | 254                   | Indian (Bangladesh) <sup>3</sup>                           | Everest (EA)       |
| 70               | INDI        | 295       | 736                   | 257                   | Indian (India, Nepal) <sup>3</sup>                         | Everest (EA)       |
| 71               | IRL         | 506       | -122                  | 611                   | Ireland 1965 <sup>3</sup>                                  | Modified Airy      |
| 72               | LUZA        | -133      | -77                   | -51                   | Luzon (Philippines excluding Mindanao Is.) <sup>3, 2</sup> | Clarke 1866        |
| 73               | LUZB        | -133      | -79                   | -72                   | Mindanao Island <sup>2</sup>                               | Clarke 1866        |
| 74               | NAHC        | -243      | -192                  | 477                   | Nahrwan (Saudi Arabia) <sup>2</sup>                        | Clarke 1880        |
| 75               | NASP        | -3        | 142                   | 183                   | N. American Caribbean <sup>2</sup>                         | Clarke 1866        |
| 76               | OGBM        | 375       | -111                  | 431                   | Great Britain 1936 (Ordinance Survey) <sup>3</sup>         | Airy 1830          |
| 77               | OHAA        | 89        | -279                  | -183                  | Hawaiian Hawaii <sup>3</sup>                               | Clarke 1866        |
| 78               | OHAB        | 45        | -290                  | -172                  | Hawaiian Kauai <sup>3</sup>                                | Clarke 1866        |
| 79               | OHAC        | 65        | -290                  | -190                  | Hawaiian Maui <sup>3</sup>                                 | Clarke 1866        |
| 80               | OHAD        | 58        | -283                  | -182                  | Hawaiian Oahu <sup>3</sup>                                 | Clarke 1866        |
| 81               | OHIA        | 229       | -222                  | -348                  | Hawaiian Hawaii <sup>3</sup>                               | International 1924 |
| 82               | OHIB        | 185       | -233                  | -337                  | Hawaiian Kauai <sup>3</sup>                                | International 1924 |
| 83               | OHIC        | 205       | -233                  | -355                  | Hawaiian Maui <sup>3</sup>                                 | International 1924 |
| 84               | OHID        | 198       | -226                  | -347                  | Hawaiian Oahu <sup>3</sup>                                 | International 1924 |
| 85               | TIL         | -679      | 669                   | -48                   | Timbalai (Brunei and East Malaysia) 1948 <sup>2</sup>      | Everest (EB)       |
| 86               | TOYM        | -148      | 507                   | 685                   | Tokyo (Japan, Korea and Okinawa) <sup>2</sup>              | Bessel 1841        |

<sup>1</sup>The DX, DY and DZ offsets are from your local datum to WGS84.

<sup>2</sup>The original LUZON values are the same as for LUZA but the original has an error in the code.



## 2.27 DGPSTXID

### *Sets DGPS station ID*

**Platform:** OEM719, OEM729, OEM7500, OEM7700, OEM7720, PwrPak7, HxGN PIM7500

This command is used to set the station ID value for the receiver when it is transmitting corrections. This allows for the easy identification of which base station was the source of the data.

For example, if you want to compare RTCM and RTCMV3 corrections, you would be easily able to identify their base stations by first setting their respective DGPSTXID values.

**Message ID:** 144

#### Abbreviated ASCII Syntax:

```
DGPSTXID type ID
```

#### Factory Default:

```
DGPSTXID auto ANY
```

#### ASCII Examples:

```
DGPSTXID RTCM 2 - using an RTCM type and ID
```

```
DGPSTXID CMR 30 - using a CMR type and ID
```

```
DGPSTXID CMR ANY - using the default CMR ID
```

```
DGPSTXID RTCA d36d - using an RTCA type and ID
```

```
DGPSTXID RTCMV3 2050 - using an RTCMV3 type and ID
```

| Field | Field Type      | ASCII Value | Binary Value | Description  | Format  | Binary Bytes | Binary Offset |
|-------|-----------------|-------------|--------------|--|---------|--------------|---------------|
| 1     | DGPSTXID header | -           | -            | Command header. See <i>Messages</i> on page 25 for more information. | -       | H            | 0             |
| 2     | type            | RTCM        | 0            | See <i>Table 52: DGPS Type</i> on page 276                           | Enum    | 4            | H             |
|       |                 | RTCA        | 1            |  |         |              |               |
|       |                 | CMR         | 2            |  |         |              |               |
|       |                 | AUTO        | 10           |  |         |              |               |
|       |                 | RTCMV3      | 13           |  |         |              |               |
| 3     | ID              | Char[5]     |              | Base Station ID String<br>See <i>Table 52: DGPS Type</i> on page 276 | Char[5] | 8            | H+4           |

## 2.28 DIFFCODEBIASCONTROL

*Enables /disables satellite differential code biases*

**Platform:** OEM719, OEM729, OEM7500, OEM7700, OEM7720, PwrPak7, HxGN PIM7500

The purpose of the differential code biases is to correct pseudorange errors that affect the L1/L2 ionospheric corrections. This command enables or disables the biases. A set of biases is included in the firmware and use of the biases is enabled by default. See also the **SETDIFFCODEBIASES** command on page 337.

**Message ID:** 913

**Abbreviated ASCII Syntax:**

```
DIFFCODEBIASCONTROL switch
```

**Factory Default:**

```
DIFFCODEBIASCONTROL enable
```

**Example:**

```
DIFFCODEBIASCONTROL disable
```

| Field | Field Type                  | ASCII Value | Binary Value | Description  | Format | Binary Bytes | Binary Offset |
|-------|-----------------------------|-------------|--------------|--|--------|--------------|---------------|
| 1     | DIFFCODEBIAS CONTROL header | -           | -            | Command header. See <i>Messages</i> on page 25 for more information. | -      | H            | 0             |
| 2     | switch                      | DISABLE     | 0            | Disable the differential code bias                                   | Enum   | 4            | H             |
|       |                             | ENABLE      | 1            | Enable the differential code bias                                    |        |              |               |

## 2.29 DLLTIMECONST

### *Sets carrier smoothing*

**Platform: OEM719, OEM729, OEM7500, OEM7700, OEM7720, PwrPak7, HxGN PIM7500**

This command sets the amount of carrier smoothing performed on the code measurements. An input value of 100 corresponds to approximately 100 seconds of smoothing. Upon issuing the command, the locktime (amount of continuous tracking in seconds) for all tracking satellites is reset to zero and each code smoothing filter is restarted. You must wait for at least the length of smoothing time for the new smoothing constant to take full effect. The optimum setting for this command depends on the application.



1. This command may not be suitable for every GNSS application.
2. When using DLLTIMECONST in differential mode with the same receivers, the same setting should be used at both the base and rover station. If the base and rover stations use different types of receivers, it is recommended that you use the command default value at each receiver (DLLTIMECONST <signaltype> 100).
3. There are several considerations when using the DLLTIMECONST command:
  - The attenuation of low frequency noise (multipath) in pseudorange measurements
  - The effect of time constants on the correlation of phase and code observations
  - The rate of “pulling-in” of the code tracking loop (step response)
  - The effect of ionospheric divergence on carrier smoothed pseudorange (ramp response)
4. To get unsmoothed pseudorange measurements, choose 0 as the time constant.

The primary reason for applying carrier smoothing to the measured pseudoranges is to mitigate the high frequency noise inherent in all code measurements. Adding more carrier smoothing by increasing the DLLTIMECONST value filters out lower frequency noise, including some multipath frequencies.

There are also some adverse effects of higher DLLTIMECONST values on some performance aspects of the receiver. Specifically, the time constant of the tracking loop is directly proportional to the DLLTIMECONST value and affects the degree of dependence between the carrier phase and pseudorange information. Carrier phase smoothing of the code measurements (pseudoranges) is accomplished by introducing data from the carrier tracking loops into the code tracking system. Phase and code data, collected at a sampling rate greater than about 3 time constants of the loop, are correlated (the greater the sampling rate, the greater the correlation). This correlation is not relevant if only positions are logged from the receiver, but is an important consideration if the data is combined in some other process such as post-mission carrier smoothing. Also, a narrow bandwidth in a feedback loop impedes the ability of the loop to track step functions. Steps in the pseudorange are encountered during initial lock-on of the satellite and when working in an environment conducive to multipath. A low DLLTIMECONST value allows the receiver to effectively adapt to these situations.



Also, increased carrier smoothing may cause problems when satellite signals are strongly affected by the ionosphere. The rate of divergence between the pseudoranges and phase-derived ranges is greatest when a satellite is low in the sky since the GPS signal must travel through a much “thicker” ionosphere. The tracking error of the receiver is greatest at these times when a lot of carrier smoothing is implemented. In addition, changing periods of ionospheric activity (diurnal changes and the 11-year cycle) influences the impact of large DLLTIMECONST values. It is important to realize that the advantages of carrier smoothing do not come without some trade off in receiver performance. The factory default DLLTIMECONST value of 100 was selected as an optimal compromise of the above considerations. For the majority of applications, this default value should be appropriate. However, the flexibility exists to adjust the parameter for specific applications by users who are familiar with the consequences.

### Message ID: 1011

#### Abbreviated ASCII Syntax:

```
DLLTIMECONST signaltype timeconst
```

#### Factory Defaults:

```
DLLTIMECONST <signaltype> 100
```

#### Example:

```
DLLTIMECONST GPSL2C 100
```

| Field | Field Type          | ASCII Value                            | Binary Value | Description  | Format | Binary Bytes | Binary Offset |
|-------|---------------------|--|--------------|--|--------|--------------|---------------|
| 1     | DLLTIMECONST header | -                                      | -            | Command header. See <i>Messages</i> on page 25 for more information. | -      | H            | 0             |
| 2     | signal type         | See <i>Table 29: Signal Type</i> below |              | Signal type  | Enum   | 4            | H             |
| 3     | time const          |  |              | Time constant (sec)  | Ulong  | 4            | H+4           |

**Table 29: Signal Type**

| Value (Binary) | Signal (ASCII) | Description      |
|----------------|----------------|------------------|
| 33             | GPSL1CA        | GPS L1 C/A-code  |
| 68             | GPSL2Y         | GPS L2 P(Y)-code |
| 69             | GPSL2C         | GPS L2 C/A-code  |

| <b>Value (Binary)</b> | <b>Signal (ASCII)</b> | <b>Description</b>                |
|-----------------------|-----------------------|-----------------------------------|
| 70                    | GPSL2P                | GPS L2 P-code                     |
| 103                   | GPSL5                 | GPS L5                            |
| 2177                  | GLOL1CA               | GLONASS L1 C/A-code               |
| 2211                  | GLOL2CA               | GLONASS L2 C/A-code               |
| 2212                  | GLOL2P                | GLONASS L2 P-code                 |
| 4129                  | SBASL1                | SBAS L1                           |
| 4194                  | SBASL5                | SBAS L5                           |
| 10433                 | GALE1                 | Galileo E1                        |
| 10466                 | GALE5A                | Galileo E5A                       |
| 10499                 | GALE5B                | Galileo E5B                       |
| 10532                 | GALALTBOC             | Galileo ALT-BOC                   |
| 12673                 | BDSB1D1               | BeiDou B1 with D1 navigation data |
| 12674                 | BDSB1D2               | BeiDou B1 with D2 navigation data |
| 12803                 | BDSB2D1               | BeiDou B2 with D1 navigation data |
| 12804                 | BDSB2D2               | BeiDou B2 with D2 navigation data |
| 12877                 | BDSB3D1               | BeiDou B3 with D1 navigation data |
| 12880                 | DBSB3D2               | BeiDou B3 with D2 navigation data |
| 14753                 | QZSSL1CA              | QZSS L1 C/A-code                  |
| 14787                 | QZSSL2C               | QZSS L2 C/A-code                  |
| 14820                 | QZSSL5                | QZSS L5                           |
| 19073                 | NAVICL5SPS            | NavIC L5 SPS                      |

## 2.30 DNSCONFIG

### *Manually configures Ethernet DNS servers*

**Platform:** OEM729, OEM7700, OEM7720, PwrPak7

This command is part of the Ethernet set up. It is used to configure the Domain Name Servers (DNS) so that host names can be used instead of IP addresses.



The **DNSCONFIG** command configures a DNS server for the Ethernet interface, ETHA.

The **DNSCONFIG** command will fail if the IP address for the Ethernet interface, ETHA, is configured to use DHCP. Ensure the IP address for the Ethernet interface is configured to use a static IP address before entering the **DNSCONFIG** command.

When using DHCP, the DNS server received using DHCP is used and the DNS server configured by **DNSCONFIG** is ignored.

**Message ID:** 1244

#### Abbreviated ASCII Syntax:

```
DNSCONFIG NumDNSSservers IP
```

#### Factory Default:

```
DNSCONFIG 0
```

#### ASCII Example:

```
DNSCONFIG 1 192.168.1.5
```

| Field | Field Type       | ASCII Value         | Binary Value | Data Description   | Format      | Binary Bytes  | Binary Offset |
|-------|------------------|---------------------|--------------|--|-------------|---------------|---------------|
| 1     | DNSCONFIG Header | -                   | -            | Command header. See <i>Messages</i> on page 25 for more information. | -           | H             | 0             |
| 2     | NumDNSServers    | 0                   | 0            | Number of DNS servers  | Enum        | 4             | H             |
|       |                  | 1                   | 1            | If this field is set to 0, an IP address is not required.            |             |               |               |
| 3     | IP               | ddd.ddd.<br>ddd.ddd |              | IP address of primary DNS server                                     | String [16] | variable<br>1 | H+4           |

<sup>1</sup>In the binary case, each string field needs to be NULL terminated and additional bytes of padding added to maintain 4-byte alignment, up to the maximum defined by the string size. The next defined field starts immediately at the next 4-byte alignment following the NULL.

## 2.31 DYNAMICS

### *Tunes receiver parameters*

**Platform:** OEM719, OEM729, OEM7500, OEM7700, OEM7720, PwrPak7, HxGN PIM7500

This command is used to adjust the receiver dynamics to that of an application. It is used to optimally tune receiver parameters.

The **DYNAMICS** command adjusts the Tracking State transition time out value of the receiver, see *Table 124: Tracking State* on page 664. When the receiver loses the position solution, see *Table 73: Solution Status* on page 419, it attempts to steer the tracking loops for fast reacquisition (5 s time-out by default). The **DYNAMICS** command adjusts this time-out value, effectively increasing the steering time. The three states AIR, LAND or FOOT set the time-out to 5, 10 or 20 seconds respectively.



The **DYNAMICS** command should only be used by advanced users. The default of AUTO should **not** be changed except under very specific conditions.

**Message ID:** 258

**Abbreviated ASCII Syntax:**

```
DYNAMICS settings
```

**Factory Default:**

```
DYNAMICS auto
```

**Example:**

```
DYNAMICS FOOT
```

| Field | Field Type      | ASCII Value   | Binary Value | Description  | Format | Binary Bytes | Binary Offset |
|-------|-----------------|---|--------------|--|--------|--------------|---------------|
| 1     | DYNAMICS header | -   | -            | Command header. See <i>Messages</i> on page 25 for more information. | -      | H            | 0             |
| 2     | settings        | See <i>Table 30: User Dynamics</i> on the next page |              | Receiver dynamics based on the current environment                   | Enum   | 4            | H             |

**Table 30: User Dynamics**

| Binary | ASCII | Description  |
|--------|-------|--|
| 0      | AIR   | Receiver is in an aircraft or a land vehicle, for example a high speed train, with velocity greater than 110 km/h (30 m/s). This is also the most suitable dynamic for a jittery vehicle at any speed. |
| 1      | LAND  | Receiver is in a stable land vehicle with velocity less than 110 km/h (30 m/s).  |
| 2      | FOOT  | Receiver is being carried by a person with velocity less than 11 km/h (3 m/s).   |
| 3      | AUTO  | Receiver monitors dynamics and adapts behavior accordingly   |



Qualifying North American Solar Challenge cars annually weave their way through 1000's of miles between the US and Canada. GNSS keeps them on track through many intersections on secondary highways and gives the Calgary team constant intelligence on the competition's every move. In this case, with average speeds of 46 miles/hour and at times a jittery vehicle, AIR is the most suitable dynamic.



## 2.32 ECHO

### *Sets port echo*

**Platform:** OEM719, OEM729, OEM7500, OEM7700, OEM7720, PwrPak7, HxGN PIM7500

This command is used to set a port to echo.

**Message ID:** 1247

**Abbreviated ASCII Syntax:**

```
ECHO [port] echo
```

**Factory Default:**

```
ECHO COM1 OFF
ECHO COM2 OFF
ECHO COM3 OFF (not supported on OEM719)
ECHO COM4 OFF (OEM7700 and OEM7720 only)
ECHO COM5 OFF (OEM7700 and OEM7720 only)
ECHO USB1 OFF
ECHO USB2 OFF
ECHO USB3 OFF
ECHO ICOM1 OFF (not supported on OEM719)
ECHO ICOM2 OFF (not supported on OEM719)
ECHO ICOM3 OFF (not supported on OEM719)
ECHO ICOM4 OFF (not supported on OEM719)
ECHO ICOM5 OFF (not supported on OEM719)
ECHO ICOM6 OFF (not supported on OEM719)
ECHO ICOM7 OFF (not supported on OEM719)
ECHO SCOM1 OFF
ECHO SCOM2 OFF
ECHO SCOM3 OFF
ECHO SCOM4 OFF
```

**ASCII Example:**

```
ECHO COM1 ON
ECHO ON
```

| Field | Field Type  | ASCII Value  | Binary Value | Description  | Format | Binary Bytes | Binary Offset |
|-------|-------------|--|--------------|--|--------|--------------|---------------|
| 1     | ECHO Header | -  | -            | Command header. See <i>Messages</i> on page 25 for more information. | -      | H            | 0             |
| 2     | port        | See <i>Table 31: Communications Port Identifiers</i> below |              | Port to configure (default = THISPORT)                               | Enum   | 4            | H             |
| 3     | echo        | OFF  | 0            | Sets port echo to off  | Enum   | 4            | H+4           |
|       |             | ON   | 1            | Sets port echo to on   |        |              |               |

**Table 31: Communications Port Identifiers**

| ASCII Port Name | Binary Value |
|-----------------|--------------|
| ALL             | 8            |
| BT1             | 33           |
| CCOM1           | 38           |
| CCOM2           | 39           |
| CCOM3           | 40           |
| CCOM4           | 41           |
| CCOM5           | 42           |
| CCOM6           | 43           |
| COM1            | 1            |
| COM2            | 2            |
| COM3            | 3            |
| COM4            | 19           |
| COM5            | 31           |
| COM6            | 32           |
| COM7            | 34           |
| COM8            | 35           |
| COM9            | 36           |

| <b>ASCII Port Name</b> | <b>Binary Value</b> |
|------------------------|---------------------|
| COM10                  | 37                  |
| ETH1                   | 20                  |
| FILE                   | 7                   |
| ICOM1                  | 23                  |
| ICOM2                  | 24                  |
| ICOM3                  | 25                  |
| ICOM4                  | 29                  |
| ICOM5                  | 46                  |
| ICOM6                  | 47                  |
| ICOM7                  | 48                  |
| IMU                    | 21                  |
| NCOM1                  | 26                  |
| NCOM2                  | 27                  |
| NCOM3                  | 28                  |
| NOPORT                 | 0                   |
| SCOM1                  | 49                  |
| SCOM2                  | 50                  |
| SCOM3                  | 51                  |
| SCOM4                  | 52                  |
| THISPORT               | 6                   |
| USB1                   | 13                  |
| USB2                   | 14                  |
| USB3                   | 15                  |
| WCOM1                  | 30                  |
| XCOM1                  | 9                   |
| XCOM2                  | 10                  |
| XCOM3                  | 17                  |

## 2.33 ECUTOFF

### *Sets satellite elevation cut-off for GPS Satellites*

**Platform: OEM719, OEM729, OEM7500, OEM7700, OEM7720, PwrPak7, HxGN PIM7500**

This command is used to set the elevation cut-off angle for tracked GPS satellites. The receiver does not start automatically searching for a GPS satellite until it rises above the cut-off angle (when satellite position is known). Tracked satellites that fall below the cut-off angle are no longer tracked unless they are manually assigned (see the **ASSIGN** command on page 66).

In either case, satellites below the ECUTOFF angle are eliminated from the internal position and clock offset solution computations.

This command permits a negative cut-off angle; it could be used in these situations:

- The antenna is at a high altitude, and thus can look below the local horizon
- Satellites are visible below the horizon due to atmospheric refraction



Care must be taken when using **ECUTOFF** command because the signals from lower elevation satellites are traveling through more atmosphere and are therefore degraded. Use of satellites below 5 degrees is not recommended.



Use the **ELEVATIONCUTOFF** command (see page 134) to set the cut-off angle for any system.



For dual antenna receivers, this command applies to both the primary and secondary antennas.

**Message ID: 50**

**Abbreviated ASCII Syntax:**

```
ECUTOFF angle
```

**Factory Default:**

```
ECUTOFF 5.0
```

**ASCII Example:**

```
ECUTOFF 10.0
```

| Field | Field Type     | ASCII Value   | Binary Value | Description  | Format | Binary Bytes | Binary Offset |
|-------|----------------|---------------|--------------|--|--------|--------------|---------------|
| 1     | ECUTOFF header | -             | -            | Command header. See <i>Messages</i> on page 25 for more information. | -      | H            | 0             |
| 2     | angle          | ±90.0 degrees |              | Elevation cut-off angle relative to horizon                          | Float  | 4            | H             |



A low elevation satellite is a satellite the receiver tracks just above the horizon. Generally, a satellite is considered low elevation if it is between 0 and 15 degrees above the horizon.

There is no difference between the data transmitted from a low elevation satellite and that transmitted from a higher elevation satellite. However, differences in the signal path of a low elevation satellite make their use less desirable. Low elevation satellite signals have more error due to the increased amount of atmosphere they must travel through. In addition, signals from low elevation satellites don't fit the assumption that a signal travels in air nearly the same as in a vacuum. As such, using low elevation satellites in the solution results in greater position inaccuracies.

The elevation cut-off angle is specified with **ECUTOFF** to ensure that noisy, low elevation satellite data below the cut-off is not used in computing a position. If post-processing data, it is still best to collect all data (even that below the cut-off angle). Experimenting with different cut-off angles can then be done to provide the best results. In cases where there are not enough satellites visible, a low elevation satellite may actually help in providing a useful solution.

## 2.34 ELEVATIONCUTOFF

*Sets the elevation cut-off angle for tracked satellites*

**Platform: OEM719, OEM729, OEM7500, OEM7700, OEM7720, PwrPak7, HxGN PIM7500**

The **ELEVATIONCUTOFF** command is used to set the elevation cut-off angle for tracked satellites. The receiver does not start automatically searching for a satellite until it rises above the cut-off angle (when the satellite position is known). Tracked satellites that fall below the cut-off angle are no longer tracked unless they are manually assigned (refer to the **ASSIGN** command on page 66).

In either case, satellites below the elevation cut-off angle are eliminated from the internal position and clock offset solution computations.

This command permits a negative cut-off angle and can be used in the following situations:

- The antenna is at a high altitude and thus can look below the local horizon
- Satellites are visible below the horizon due to atmospheric refraction



Care must be taken when using **ELEVATIONCUTOFF** command because the signals from lower elevation satellites are traveling through more atmosphere and are therefore degraded. Use of satellites below 5 degrees is not recommended.



This command combines the following commands into one convenient command: **ECUTOFF, GLOECUTOFF, GALECUTOFF, QZSSECUTOFF, SBASECUTOFF, BDSECUTOFF** and **NAVICECUTOFF**.



For dual antenna receivers, this command applies to both the primary and secondary antennas.



A low elevation satellite is a satellite the receiver tracks just above the horizon. Generally, a satellite is considered low elevation if it is between 0 and 15 degrees above the horizon.

There is no difference between the data transmitted from a low elevation satellite and that transmitted from a higher elevation satellite. However, differences in the signal path of a low elevation satellite make their use less desirable. Low elevation satellite signals have more error due to the increased amount of atmosphere they must travel through. In addition, signals from low elevation satellites don't fit the assumption that a signal travels in air nearly the same as in a vacuum. As such, using low elevation satellites in the solution results in greater position inaccuracies.

The elevation cut-off angle is specified with the **ELEVATIONCUTOFF** command to ensure that noisy, low elevation satellite data below the cut-off is not used in computing a position. If post-processing data, it is still best to collect all data (even that below the cutoff angle). Experimenting with different cut-off angles can then be done to provide the best results. In cases where there are not enough satellites visible, a low elevation satellite may actually help in providing a useful solution.

#### Message ID: 1735

#### Abbreviated ASCII Syntax:

```
ELEVATIONCUTOFF Constellation Angle [Reserved]
```

#### Factory default:

```
ELEVATIONCUTOFF ALL 5.0 0
```

#### ASCII Example:

```
ELEVATIONCUTOFF GPS 5
```

```
ELEVATIONCUTOFF ALL 5
```

| Field | Field Type              | ASCII Value | Binary Value | Description  | Format | Binary Bytes | Binary Offset |
|-------|-------------------------|-------------|--------------|--|--------|--------------|---------------|
| 1     | ELEVATION CUTOFF header | -           | -            | Command header. See <i>Messages</i> on page 25 for more information. | -      | H            | 0             |

| Field | Field Type    | ASCII Value   | Binary Value | Description  | Format | Binary Bytes | Binary Offset |
|-------|---------------|---------------|--------------|--|--------|--------------|---------------|
| 2     | Constellation | GPS           | 0            | Sets the cut-off angle for GPS Constellation satellites only.              | Enum   | 4            | H             |
|       |               | GLONASS       | 1            | Sets the cut-off angle for GLONASS constellation satellites only.          |        |              |               |
|       |               | SBAS          | 2            | Sets the cut-off angle for SBAS constellation satellites only.             |        |              |               |
|       |               | GALILEO       | 5            | Sets the cut-off angle for Galileo constellation satellites only.          |        |              |               |
|       |               | BEIDOU        | 6            | Sets the cut-off angle for BeiDou constellation satellites only.           |        |              |               |
|       |               | QZSS          | 7            | Sets the cut-off angle for QZSS constellation satellites only.             |        |              |               |
|       |               | NAVIC         | 9            | Sets the cut-off angle for NavIC constellation satellites only.            |        |              |               |
|       |               | ALL           | 32           | Sets the cut-off angle for all satellites regardless of the constellation. |        |              |               |
| 3     | Angle         | ±90.0 degrees |              | Elevation cut-off angle relative to the horizon.                           | Float  | 4            | H+4           |
| 4     | Reserved      | 0             |              | Reserved Field (optional)  | Ulong  | 4            | H+8           |



## 2.35 ETHCONFIG

### *Configures Ethernet physical layer*

**Platform:** OEM729, OEM7700, OEM7720, PwrPak7

This command is used to configure the Ethernet physical layer.

**Message ID:** 1245

**Abbreviated ASCII Syntax:**

```
ETHCONFIG interface_name [speed] [duplex] [crossover] [power_mode]
```

**Factory Default:**

```
ETHCONFIG etha auto auto auto powerdown
```

**ASCII Example:**

```
ETHCONFIG etha 100 full mdix normal
```

| Field | Field Type       | ASCII Value | Binary Value | Description  | Format | Binary Bytes | Binary Offset |
|-------|------------------|-------------|--------------|--|--------|--------------|---------------|
| 1     | ETHCONFIG Header | -           | -            | Command header. See <i>Messages</i> on page 25 for more information.   | -      | H            | 0             |
| 2     | interface_name   | ETHA        | 2            | Name of the Ethernet interface   | Enum   | 4            | H             |
| 3     | speed            | AUTO        | 1            | Auto-negotiate speed (default)<br>AUTO is the recommended value for the speed parameter.<br>If setting speed to AUTO, duplex must be set to AUTO at the same time otherwise a "parameter 3 out of range" error occurs. | Enum   | 4            | H+4           |
|       |                  | 10          | 2            | Force 10BaseT  |        |              |               |
|       |                  | 100         | 3            | Force 100BaseT   |        |              |               |

| Field | Field Type | ASCII Value | Binary Value | Description   | Format | Binary Bytes | Binary Offset |
|-------|------------|-------------|--------------|---|--------|--------------|---------------|
| 4     | duplex     | AUTO        | 1            | Auto-negotiate duplex (default)<br>If setting duplex to AUTO, speed must be set to AUTO at the same time otherwise a "parameter 3 out of range" error occurs. | Enum   | 4            | H+8           |
|       |            | HALF        | 2            | Force half duplex   |        |              |               |
|       |            | FULL        | 3            | Force full duplex   |        |              |               |
| 5     | crossover  | AUTO        | 1            | Auto-detect crossover (default)   | Enum   | 4            | H+12          |
|       |            | MDI         | 2            | Force MDI (straight through)  |        |              |               |
|       |            | MDIX        | 3            | Force MDIX (crossover)  |        |              |               |
| 6     | power_mode | AUTO        | 1            | Energy detect mode  | Enum   | 4            | H+16          |
|       |            | POWERDOWN   | 2            | Soft power down mode (default)  |        |              |               |
|       |            | NORMAL      | 3            | Normal mode   |        |              |               |



The crossover parameter is ignored on OEM7 receivers, as the hardware automatically detects the cable connection and configures the interface for proper communication. For backwards compatibility, the crossover options are still accepted, but have no functional impact.

## 2.36 EVENTINCONTROL

### *Controls Event-In input triggers*

**Platform: OEM719, OEM729, OEM7500, OEM7700, OEM7720, PwrPak7, HxGN PIM7500**

This command controls up to four Event-In input triggers. Each input can be used as either an event strobe or a pulse counter.

When used as an event strobe, an accurate GPS time or position is applied to the rising or falling edge of the input event pulse (refer to the **MARKTIME, MARK2TIME, MARK3TIME and MARK4TIME** log on page 572, **MARKPOS, MARK2POS, MARK3POS and MARK4POS** log on page 569 or **MARK1PVA, MARK2PVA, MARK3PVA and MARK4PVA** log on page 961). Each input strobe is usually associated with a separate device, therefore different solution output lever arm offsets can be applied to each strobe. When used as an Event Input Trigger, it is possible to overwhelm the receiver with a very high rate of input events that impacts the performance of the receiver. For this reason, the receiver internally throttles the rate at which it responds to input events. The limit is 200 Hz. Throttling only applies when the input is used as an event strobe input; throttling does not apply when used in pulse counter mode.

When used as a pulse counter, an internal accumulator is used to increment each input pulse and output each second using the **MARK1COUNT, MARK2COUNT, MARK3COUNT and MARK4COUNT** log (see page 567) coordinated with 1 PPS. The accumulator begins counting from zero with each new second.

**Message ID: 1637**

#### Abbreviated ASCII Syntax:

```
EVENTINCONTROL mark switch [polarity] [t_bias] [t_guard]
```

#### ASCII Example:

```
EVENTINCONTROL MARK1 ENABLE
```

| Field | Field Type            | ASCII Value | Binary Value | Description  | Format | Binary Bytes | Binary Offset |
|-------|-----------------------|-------------|--------------|--|--------|--------------|---------------|
| 1     | EVENTINCONTROL header | -           | -            | Command header. See <i>Messages</i> on page 25 for more information.   | -      | H            | 0             |
| 2     | mark                  | MARK1       | 0            | Choose which Event-In Mark to change. This value must be specified.<br><br><b>Note:</b> MARK3 and MARK4 are available only on OEM7700 and OEM7720 receivers. | Enum   | 4            | H             |
|       |                       | MARK2       | 1            |  |        |              |               |
|       |                       | MARK3       | 2            |  |        |              |               |
|       |                       | MARK4       | 3            |  |        |              |               |

| Field | Field Type | ASCII Value   | Binary Value | Description  | Format | Binary Bytes | Binary Offset |
|-------|------------|---|--------------|--|--------|--------------|---------------|
| 3     | switch     | DISABLE   | 0            | Disables Event Input   | Enum   | 4            | H+4           |
|       |            | EVENT   | 1            | Enables Event Input  |        |              |               |
|       |            | COUNT   | 2            | Enables the Event Input as a counter. Increments a counter with each input pulse (for example, a wheel sensor. The period of the count is from one PPS to the next PPS.                                |        |              |               |
|       |            | ENABLE  | 3            | A synonym for the EVENT option (for compatibility with previous releases)  |        |              |               |
| 4     | polarity   | NEGATIVE  | 0            | Negative polarity (default)  | Enum   | 4            | H+8           |
|       |            | POSITIVE  | 1            | Positive polarity  |        |              |               |
| 5     | t_bias     | default: 0<br>minimum: -999,999,999<br>maximum: 999,999,999 |              | A constant time bias in nanoseconds can be applied to each event pulse. Typically this is used to account for a transmission delay.<br><br>This field is not used if the switch field is set to COUNT. | Long   | 4            | H+12          |
| 6     | t_guard    | default: 4<br>minimum: 2<br>maximum: 3,599,999              |              | The time guard specifies the minimum number of milliseconds between pulses. This is used to coarsely filter the input pulses.<br><br>If Field 3 is COUNT, this field is not used.                      | Ulong  | 4            | H+16          |

## 2.37 EVENTOUTCONTROL

### *Control Event-Out properties*

**Platform: OEM719, OEM729, OEM7500, OEM7700, OEM7720, PwrPak7, HxGN PIM7500**

This command configures up to seven Event-Out output strobes. The event strobes toggle between 3.3 V and 0 V. The pulse consists of two periods: one active period followed by a not active period. The start of the active period is synchronized with the top of the GNSS time second and the signal polarity determines whether the active level is 3.3 V or 0 V. The not active period immediately follows the active period and has the alternate voltage.



The outputs that are available vary according to the platform.



A 100 MHz clock is used internally to create these output signals. As a result, all period values are limited to 10 ns steps.



The EVENTOUT outputs cannot synchronize with GPS time until the receiver reaches FINESTEERING time status. As the receiver transitions to GPS time, there may be additional, unexpected pulses on the EVENTOUT signals.

**Message ID: 1636**

#### **Abbreviated ASCII Syntax:**

```
EVENTOUTCONTROL mark switch [polarity] [active_period] [non_active_period]
```

#### **ASCII Example:**

```
EVENTOUTCONTROL MARK3 ENABLE
```

| Field | Field Type              | ASCII Value | Binary Value | Description  | Format | Binary Bytes | Binary Offset |
|-------|-------------------------|-------------|--------------|--|--------|--------------|---------------|
| 1     | EVENTOUT CONTROL header | -           | -            | Command header. See <i>Messages</i> on page 25 for more information. | -      | H            | 0             |

| Field | Field Type                 | ASCII Value   | Binary Value | Description   | Format | Binary Bytes | Binary Offset |   |  |
|-------|----------------------------|---|--------------|---|--------|--------------|---------------|---|--|
| 2     | mark                       | MARK1   | 0            | Choose which Event-Out Mark to change. This value must be specified.  | Enum   | 4            | H             |   |  |
|       |                            | MARK2   | 1            |   |        |              |               |   |  |
|       |                            | MARK3   | 2            | <b>Note:</b> On OEM719 and OEM729 receivers, only MARK1 is available.   |        |              |               |   |  |
|       |                            | MARK4   | 3            |   |        |              |               |   |  |
|       |                            | MARK5   | 4            |   |        |              |               |   |  |
|       |                            |   |              | MARK6   |        |              |               | 5 | <b>Note:</b> On OEM7700 and OEM7720 receivers, only Mark1 through Mark4 are available. |
|       |                            |   |              | MARK7   |        |              |               | 6 |  |
| 3     | switch                     | DISABLE   | 0            | Disables the Event output   | Enum   | 4            | H+4           |   |  |
|       |                            | ENABLE  | 1            | Enables the Event output  |        |              |               |   |  |
| 4     | polarity                   | NEGATIVE  | 0            | Negative polarity (active = 0V) (default)   | Enum   | 4            | H+8           |   |  |
|       |                            | POSITIVE  | 1            | Positive polarity (active = 3.3V)   |        |              |               |   |  |
| 5     | active_period <sup>a</sup> | default:<br>500,000,000<br>minimum: 10<br>maximum:<br>999,999,990 |              | Active period of the Event Out signal in nanoseconds.<br><br>10ns steps must be used.<br><br><b>Note:</b> If the value entered is not a multiple of 10, it will be rounded down to the nearest 10 ns. | Ulong  | 4            | H+12          |   |  |

<sup>a</sup>The sum of the active period and inactive period should total 1,000,000,000 ns. If the total exceeds one full second, the active period duration will be as given and the inactive period will be the remainder of the second.

Alternately, the sum of the active and inactive periods may be less than 1,000,000,000 ns, but should divide evenly into 1,000,000,000 ns. For example, if the active period is 150,000,000 and the inactive period is 50,000,000, the sum of the periods is 200,000,000 ns which divides evenly into one full second.

If the sum is less than one full second and not an even multiple, the last active or inactive period is stretched or truncated to equal one full second.

A 100 MHz clock is used internally to create these output signals. As a result, all period values are limited to 10 ns steps.

| Field | Field Type                     | ASCII Value   | Binary Value | Description  | Format | Binary Bytes | Binary Offset |
|-------|--------------------------------|---|--------------|--|--------|--------------|---------------|
| 6     | non_active_period <sup>a</sup> | default:<br>500,000,000<br>minimum: 10<br>maximum:<br>999,999,990 |              | Non-active period of the Event Out signal in nanoseconds.<br>10 ns steps must be used.<br><b>Note:</b> If the value entered is not a multiple of 10, it will be rounded down to the nearest 10 ns. | Ulong  | 4            | H+16          |

## 2.38 EXTERNALCLOCK

### *Sets external clock parameters*

**Platform: OEM729**

The **EXTERNALCLOCK** command is used to enable the OEM7 card to operate with an optional external oscillator. You are able to optimally adjust the clock model parameters of these receivers for various types of external clocks.



1. This command affects the interpretation of the CLOCKMODEL log.
2. If the **EXTERNALCLOCK** command is enabled and set for an external clock (TCXO, OCXO, RUBIDIUM, CESIUM or USER) and the **CLOCKADJUST** command (see page 101) is ENABLED, then the clock steering process takes over the VARF output pins and may conflict with a previously entered **FREQUENCYOUT** command (see page 167). If clocksteering is not used with the external oscillator, the clocksteering process must be disabled by using the **CLOCKADJUST disable** command.
3. When using the **EXTERNALCLOCK** command and **CLOCKADJUST** command together, issue the **EXTERNALCLOCK** command first to avoid losing satellites.

There are three steps involved in using an external oscillator:

1. Follow the procedure outlined in the [OEM7 Installation and Operation User Manual](#) to connect an external oscillator to the OEM7.
2. Using the **EXTERNALCLOCK** command, select a standard oscillator and its operating frequency.
3. Using the **CLOCKADJUST** command, disable the clocksteering process if external clocksteering is not used.

An unsteered oscillator can be approximated by a three-state clock model, with two states representing the range bias and range bias rate, and a third state assumed to be a Gauss-Markov (GM) process representing the range bias error generated from satellite clock dither. The third state is included because the Kalman filter assumes an (unmodeled) white input error. The significant correlated errors produced by satellite clock dither are obviously not white and the Markov process is an attempt to handle this kind of short term variation.

The internal units of the new clock model's three states (offset, drift and GM state) are metres, metres per second and metres. When scaled to time units for the output log, these become seconds, seconds per second and seconds, respectively.

The user has control over 3 process noise elements of the linear portion of the clock model. These are the  $h_0$ ,  $h_{-1}$  and  $h_{-2}$  elements of the power law spectral density model used to describe the frequency noise characteristics of oscillators:

$$S_y(f) = \frac{h_{-2}}{f^2} + \frac{h_{-1}}{f} + h_0 + h_1 f + h_2 f^2$$

where  $f$  is the sampling frequency and  $S_y(f)$  is the clock's power spectrum. Typically only  $h_0$ ,  $h_{-1}$ , and  $h_{-2}$  affect the clock's Allan variance and the clock model's process noise elements.

Before using an optional external oscillator, several clock model parameters must be set. There are default settings for a Voltage-Controlled Temperature-Compensated Crystal Oscillator



VCTCXO), Ovenized Crystal Oscillator (OCXO), Rubidium and Cesium standard, which are given in *Table 32: Clock Type* on the next page. You may alternatively choose to supply customized settings.



The **EXTERNALCLOCK** command determines whether the receiver uses its own internal temperature-compensated crystal oscillator or that of an external oscillator as a frequency reference. It also sets which clock model is used for an external oscillator.

To force the OEM7 to use the internal oscillator, use the **EXTERNALCLOCK disable** command and physically disconnect the external oscillator input. Do not use the EXTERNALCLOCK OCXO, CESIUM, RUBIDIUM or USER parameters if there is no external oscillator connected to the OEM7.

### Message ID: 230

#### Abbreviated ASCII Syntax:

```
EXTERNALCLOCK clocktype [freq] [h0[h-1[h-2]]]
```

#### Factory Default:

```
EXTERNALCLOCK disable
```

#### ASCII Examples:

```
EXTERNALCLOCK USER 10MHZ 1.0167e-23 6.87621e-25 8.1762e-26
```

```
EXTERNALCLOCK TCXO 5MHZ
```

| Field | Field Type           | ASCII Value                                      | Binary Value | Description  | Format | Binary Bytes | Binary Offset |
|-------|----------------------|--|--------------|--|--------|--------------|---------------|
| 1     | EXTERNALCLOCK header | -  | -            | Command header. See <i>Messages</i> on page 25 for more information.   | -      | H            | 0             |
| 2     | clocktype            | See <i>Table 32: Clock Type</i> on the next page |              | Clock type   | Enum   | 4            | H             |
| 3     | freq                 | 5MHz   | 1            | Optional frequency. If a value is not specified, the default is 5 MHz  | Enum   | 4            | H+4           |
|       |                      | 10MHz  | 2            |  |        |              |               |
| 4     | h <sub>0</sub>       | 1.0 e-35 to 1.0 e-18                             |              | Optional timing standards. These fields are only valid when the USER clocktype is selected. Do not use h values with VCTCXO, OCXO, CESIUM or RUBIDIUM clock types. The h values for these options are fixed, see <i>Table 33: Pre-Defined Values for Oscillators</i> below (default=0.0) | Double | 8            | H+8           |
| 5     | h <sub>-1</sub>      | 1.0 e-35 to 1.0 e-18                             |              |  | Double | 8            | H+16          |
| 6     | h <sub>-2</sub>      | 1.0 e-35 to 1.0 e-18                             |              |  | Double | 8            | H+24          |

**Table 32: Clock Type**

| ASCII    | Binary | Description   |
|----------|--------|---|
| DISABLE  | 0      | Turns the external clock input off, reverts back to the on-board VCTCXO. When used in a binary command, use the parameter defaults (i.e. freq=1, $h_0=0$ , $h_{-1}=0$ , $h_{-2}=0$ ). |
| TCXO     | 1      | Sets the predefined values for a VCTCXO   |
| OCXO     | 2      | Sets the predefined values for an OCXO  |
| RUBIDIUM | 3      | Sets the predefined values for a rubidium oscillator  |
| CESIUM   | 4      | Sets the predefined values for a cesium oscillator  |
| USER     | 5      | Defines custom process noise elements   |

**Table 33: Pre-Defined Values for Oscillators**

| Clock Type | $h_0$     | $h_{-1}$  | $h_{-2}$  |
|------------|-----------|-----------|-----------|
| VCTCXO     | 1.0 e-21  | 1.0 e-20  | 1.0 e-20  |
| OCXO       | 2.51 e-26 | 2.51 e-23 | 2.51 e-22 |
| Rubidium   | 1.0 e-23  | 1.0 e-22  | 1.3 e-26  |
| Cesium     | 2.0 e-20  | 7.0 e-23  | 4.0 e-29  |

## 2.39 FILEAUTOTRANSFER

*Enables/Disables automatic file transfer*

### Platform: PwrPak7

Use this command to configure the automatic transfer function from internal memory to an external USB stick. If the mode is set to COPY or MOVE, all log files, except the file currently being logged to, will be automatically transferred to a USB stick when the USB stick is inserted.

This command will transfer all recorded log files to the USB stick provided the USB stick has enough free space to hold all the data. **Files too large to fit in the remaining space on the USB stick are skipped.**

The command must be issued before the USB stick is inserted. If the command is not issued first, the USB stick must be removed and reinserted to trigger the auto transfer.

The status of the transfer can be viewed by logging the **FILETRANSFERSTATUS** log (see page 461).

A transfer in progress can be canceled by issuing the **FILETRANSFER CANCEL** command.

The settings for this command can be saved using the **SAVECONFIG** command (see page 311).

### Message ID: 2135

### Abbreviated ASCII Syntax:

```
FILEAUTOTRANSFER [FileAutoTransferMode]
```

### ASCII Example:

```
FILEAUTOTRANSFER COPY
```

| Field | Field Type              | ASCII Value | Binary Value | Description   | Binary Format | Binary Bytes | Binary Offset |
|-------|-------------------------|-------------|--------------|---|---------------|--------------|---------------|
| 1     | FILEAUTOTRANSFER header | -           | -            | Command header. See <i>Messages</i> on page 25 for more information.                              | -             | H            | 0             |
| 2     | FileAutoTransferMode    | 1           | OFF          | Automatic copy/move is disabled (default)   | Ulong         | 4            | H             |
|       |                         | 2           | COPY         | Automatically copies all files  |               |              |               |
|       |                         | 3           | MOVE         | Automatically copies all files and then deletes them from internal memory after a successful copy |               |              |               |



For the fastest transfer of files to an external memory stick, it is recommended that logging to a file be stopped.

## 2.40 FILECONFIG

### *Open or close a log file*

**Platform: OEM719, OEM729, OEM7500, OEM7700, OEM7720, PwrPak7, HxGN PIM7500**

To record logs, log requests are sent to the FILE port. Before the logs sent to the FILE port can be saved in a file, the file must be opened using the **FILECONFIG** command.

When configured to be open, a log file will be opened when the active file media is ready and has sufficient space. Once a log file is opened, any logs requested for the FILE port are recorded to the file.

Use the **FILESTATUS** log (see page 455) to determine the state of the log file.



The file media is separately configured:

- On core cards, this is always USBSTICK, which is the only media available.
- On Enclosure products, the active file media is configured using a product-specific command, such as **FILEMEDIACONFIG** command on page 152.

When a file is opened, the file name is automatically generated based on the following format:

<PSN>\_<INDEX>.LOG

where:

- <PSN> is the PSN of the receiver
- <INDEX> is a number from 1 to 511.

The lowest number that produces an unused file name is selected. If there is no such number available, the **FILESTATUS** log (see page 455) will report an error.

The number is not zero-padded (i.e. the sequence is as follows: 1,2, ... ,9,10,11,12, ... ,99,100, ... , 510,511).

When a file is closed and the receiver has a valid time, the file is renamed based on the following format:

<PSN>\_<UTC Date>\_<UTC Time>.LOG

where:

- <PSN> is the PSN of the receiver
- <UTC\_Date> is the UTC date in the format YYYY-MM-DD
- <UTC\_Time> is the UTC time in the format HH-MM-SS

Example file name: NOV12001200A\_2017-01-10\_12-14-34.LOG

When a file is closed, but the receiver does not have a valid time, the file is left with its automatically generated name.

#### **Other Notes:**

- The FILE port represents the internal logging to flash memory. It has a NOVATEL Interface Mode - output only, no input is possible.

- Only logs that are published after the log file is open are recorded.
- Only one log file can be open at a time.
- Logs requested to the FILE port are still produced even if the log file is closed, however the logs are not recorded. (This is similar to requesting logs to COM4 when there's no cable on COM4.) If a new log file is opened, recording of the previously requested logs continues with the new file.
- When a file is closed, the log file is renamed to the format <PSN>\_<UTC Date>\_<UTC Time>.LOG, where the UTC time is the time when the file is closed. If the time is not available, the file is not renamed. If there is already a file with the intended name, the file is not renamed.
- After closing a file, the file system will be flushed to ensure that all data is written to the media.
- A disk is considered "full" when it has  $\leq 10$  MB of free space. This buffer is left in place to allow the system time and space to open up a new file if required.

**Message ID: 2116****Abbreviated ASCII Syntax:**

```
FILECONFIG [FileOperation]
```

**Example:**

```
FILECONFIG OPEN
```

| Field | Field Type        | ASCII Value | Binary Value | Description  | Format | Binary Bytes | Binary Offset |
|-------|-------------------|-------------|--------------|--|--------|--------------|---------------|
| 1     | FILECONFIG header | -           | -            | Command header. See <i>Messages</i> on page 25 for more information. | -      | H            | 0             |
| 2     | FileOperation     | 1           | OPEN         | Open (create) a new logging file                                     | Enum   | 4            | H             |
|       |                   | 2           | CLOSE        | Close the logging file   |        |              |               |

## 2.41 FILEDELETE

**Deletes files from the currently selected mass storage device**

**Platform: OEM719, OEM729, OEM7500, OEM7700, OEM7720, PwrPak7, HxGN PIM7500**

Use this command to delete a single file, or use the wild card symbol (\*) to delete all files, from the logging directory of the currently selected file media. This command will not delete a file if it is currently open for logging. Use the **FILESTATUS** log (see page 455) to determine the state of the log file.



The wild card symbol deletes all files in the directory. It cannot be used to delete a subset of the files in the directory. For example, the command **FILEDELETE \*.LOG** will be rejected by the receiver.

The file media is separately configured:

- On receiver cards, the file media is always USBSTICK, which is the only media available.
- On enclosure products, the active file media is configured using a product-specific command, such as **FILEMEDIACONFIG** command (see page 152).

The list of files stored on the currently selected file media can be retrieved using the **FILELIST** log on page 453.

**Message ID: 2190**

**Abbreviated ASCII Syntax:**

```
FILEDELETE FileName
```

**Example:**

```
FILEDELETE NMNE17130016A_2017-12-11_18-17-06.LOG - Delete the file
NMNE17130016A_2017-12-11_18-17-06.LOG
```

| Field | Field Type        | Description  | Format           | Binary Bytes  | Binary Offset |
|-------|-------------------|--|------------------|---------------|---------------|
| 1     | FILEDELETE header | Command header. See <i>Messages</i> on page 25 for more information. |                  | H             | 0             |
| 2     | FileName          | Name of file to delete, or the wild card symbol (*)                  | String (Max 128) | variable<br>1 | H             |

<sup>1</sup>In the binary case, each string field needs to be NULL terminated and additional bytes of padding added to maintain 4-byte alignment, up to the maximum defined by the string size. The next defined field starts immediately at the next 4-byte alignment following the NULL.

## 2.42 FILEMEDIACONFIG

### *Specify the file media*

#### **Platform: PwrPak7**

Use this command to specify which storage media is used for File operations.

To determine what storage device is currently being used for File operations, log this command. For example:

```
LOG FILEMEDIACONFIG
```

#### **Message ID: 2117**

#### **Abbreviated ASCII Syntax:**

```
FILEMEDIACONFIG <MassStorage>
```

#### **ASCII Example:**

```
FILEMEDIACONFIG INTERNAL_FLASH    - Use internal flash as the media
FILEMEDIACONFIG USBSTICK          - Use a USB stick as the media
```

| Field | Field Type             | ASCII Value | Binary Value   | Description  | Format | Binary Bytes | Binary Offset |
|-------|------------------------|-------------|----------------|--|--------|--------------|---------------|
| 1     | FILEMEDIACONFIG header | -           | -              | Command header. See <i>Messages</i> on page 25 for more information. | -      | H            | 0             |
| 2     | MassStorageDevice      | 1           | USBSTICK       | Use a USB stick as the mass storage device                           | Enum   | 4            | H             |
|       |                        | 2           | INTERNAL_FLASH | Use Internal storage as the mass storage device                      |        |              |               |



## 2.43 FILEROTATECONFIG

### *Set the maximum size and duration of a log file*

**Platform: OEM719, OEM729, OEM7500, OEM7700, OEM7720, PwrPak7, HxGN PIM7500**

Use this command to configure the maximum size and duration for a log file. This command also configures the action taken when the log file media is full.

A file rotation is when a new file is opened, the currently opened file is closed and logging the FILE port is rerouted to this new file. There is no data loss during this process and individual logs within the file are not spread between log files.

**Message ID: 2133**

#### **Abbreviated ASCII Syntax:**

```
FILEROTATECONFIG [Max File Time] [Max File Size] [Disk Full Action]
```

#### **Example:**

```
FILEROTATECONFIG 2 4096 STOP
```

The file is left open for 2 hours or until the file size reaches 4096 MB. When the log file media is full, the file is closed.

```
FILEROTATECONFIG 4 4096 OVERWRITE
```

The file is left open for 4 hours or until the file size reaches 4096 MB. When the log media file is full, the oldest file on the log media file will be deleted.

| Field | Field Type               | ASCII Value | Binary Value | Description   | Format | Binary Bytes | Binary Offset |
|-------|--------------------------|-------------|--------------|---|--------|--------------|---------------|
| 1     | FILEROTATE CONFIG header | -           | -            | Command header. See <i>Messages</i> on page 25 for more information.  | -      | H            | 0             |
| 2     | Max File Time            | 0 to 24     |              | Maximum number of hours to leave a file open before triggering a file rotation.<br>Set to 0 for no maximum time.<br>Maximum value is 24.<br>Default is 0. | Ushort | 2            | H             |

| Field | Field Type    | ASCII Value | Binary Value | Description  | Format | Binary Bytes | Binary Offset |
|-------|---------------|-------------|--------------|--|--------|--------------|---------------|
| 3     | Max File Size | 1 to 4096   |              | Maximum number of mega bytes (MB) for the file size. A file rotation is triggered when the file is within 1 MB of this size.<br>Maximum value is 4096 MB<br>Default is 4096 MB (4 GB). | Ushort | 2            | H+2           |

| Field | Field Type       | ASCII Value | Binary Value | Description  | Format | Binary Bytes | Binary Offset |
|-------|------------------|-------------|--------------|--|--------|--------------|---------------|
| 4     | Disk Full Action | 0           | STOP         | Stops logging when the file media has 1 MB of free space or less.  | Enum   | 4            | H+4           |
|       |                  | 1           | OVERWRITE    | <p>Deletes the oldest log file when the file media has 10 MB of free space or less.</p> <p>To be selected for deletion a file must satisfy these requirements:</p> <ul style="list-style-type: none"> <li>The file must use the <b>FILECONFIG</b> command (see page 149) file name format.</li> <li>The &lt;PSN&gt; value must match the current receiver.</li> </ul> <p>File age is determined using the <b>FILECONFIG</b> command (see page 149) file name format.</p> <ul style="list-style-type: none"> <li>Temporary files (i.e. those with an &lt;INDEX&gt; value) are considered oldest. Such files will be sorted by their &lt;INDEX&gt; value with lower values considered older.</li> <li>Non-temporary files will be sorted by the date reported in the file format.</li> </ul> |        |              |               |

## 2.44 FILETRANSFER

### *Copy files from internal memory*

#### Platform: PwrPak7

Use this command to copy files from internal memory to a USB stick. This command can also be used to cancel file transfer in progress.



This command returns a response immediately to show that the copy/move operation started. However, the actual transfer of files will take some time. Use the **FILETRANSFERSTATUS** log (see page 461) to monitor the status of the file transfer.

To view the names of the files in memory, log the **FILELIST** log (see page 453).

#### Message ID: 2109

#### Abbreviated ASCII Syntax:

```
FILETRANSFER [FileTransferOperation] <FileName>
```

#### ASCII Examples:

```
FILETRANSFER COPY ALL      - Copies all files on internal memory
```

```
FILETRANSFER MOVE BMHR16460033T_2017-3-16_21-18-48.log
```

```
FILETRANSFER CANCEL      - Cancels file transfer operation
```

| Field | Field Type            | ASCII Value | Binary Value | Description  | Binary Format | Binary Bytes | Binary Offset |
|-------|-----------------------|-------------|--------------|--|---------------|--------------|---------------|
| 1     | FILETRANSFER header   | -           | -            | Command header. See <i>Messages</i> on page 25 for more information. | -             | H            | 0             |
| 2     | FileTransferOperation | 1           | COPY         | Copy the file  | Enum          | 4            | H             |
|       |                       | 2           | MOVE         | Copy the file and then delete file from internal memory              |               |              |               |
|       |                       | 3           | CANCEL       | Cancels the file transfer currently in progress                      |               |              |               |

| Field | Field Type | ASCII Value | Binary Value | Description  | Binary Format | Binary Bytes | Binary Offset |
|-------|------------|-------------|--------------|--|---------------|--------------|---------------|
| 3     | FileName   |             |              | The name of the file to be moved or copied.<br>To move or copy all of the files on internal memory, use ALL. | String        | Variable     | H+4           |

## 2.45 FIX

### *Constrains to fixed height or position*

**Platform: OEM719, OEM729, OEM7500, OEM7700, OEM7720, PwrPak7, HxGN PIM7500**

This command is used to fix height or position to the input values. For various applications, fixing these values can assist in improving acquisition times and accuracy of position or corrections. For example, fixing the position is a requirement for differential base stations as it provides the reference position to base the differential corrections from.

If you enter a **FIXPOSDATUM** command (see page 162), the **FIX** command is then issued internally with the **FIXPOSDATUM** command (see page 162) values translated to WGS84. It is the **FIX** command that appears in the RXCONFIG log. If the **FIX** command or the **FIXPOSDATUM** command (see page 162) are used, their newest values overwrite the internal FIX values.



1. It is strongly recommended that the FIX POSITION entered be accurate to within a few metres. This level of accuracy can be obtained from a receiver using single point positioning once 5 or 6 satellites are being tracked.
2. FIX POSITION should only be used for base station receivers. Applying FIX POSITION to a rover switches it from RTK mode to a fixed position mode. Applying FIX POSITION to the rover does not speed up ambiguity resolution.
3. Any setting other than FIX POSITION disables output of differential corrections unless the **MOVINGBASESTATION** command (see page 234) is set to ENABLE.
4. You can fix the position of the receiver using latitude, longitude and height in Mean Sea Level (MSL) or ellipsoidal parameters depending on the UNDULATION setting. The factory default for the **UNDULATION** command (see page 371) setting is EGM96, where the height entered in the **FIX** command is set as MSL height. If you change the UNDULATION setting to USER 0, the height entered in the **FIX** command is set as ellipsoidal height (refer to *Table 34: FIX Parameters* on the next page).

Error checking is performed on the entered fixed position by the integrity monitor. Depending on the result of this check, the position can be flagged with the following statuses.

- SOL\_COMPUTED: The entered position has been confirmed by measurement.
- PENDING: Insufficient measurements are available to confirm the entered position.
- INTEGRITY\_WARNING: First level of error when an incorrect position has been entered. The fixed position is off by approximately 25-50 meters.
- INVALID\_FIX: Second level of error when an inaccurate position has been entered. The fixed position is off by a gross amount.



An incorrectly entered fixed position will be flagged either INTEGRITY\_WARNING or INVALID\_FIX. This will stop output of differential corrections or RTK measurements and can affect the clock steering and satellite signal search. Checks on the entered fixed position can be disabled using the **RAIMMODE** command (see page 284).

**Message ID: 44****Abbreviated ASCII Syntax:**

```
FIX type [param1 [param2 [param3]]]
```

**Factory Default:**

```
FIX none
```

**ASCII Example:**

```
FIX none
FIX HEIGHT 4.567
FIX position 51.116 -114.038 1065.0
```



In order to maximize the absolute accuracy of RTK rover positions, the base station coordinates must be fixed to their known position using the **FIX POSITION [lat][lon][hgt]** command.

| Field | Field Type | ASCII Value                                     | Binary Value | Description  | Format | Binary Bytes | Binary Offset |
|-------|------------|---|--------------|--|--------|--------------|---------------|
| 1     | FIX header | -   | -            | Command header. See <i>Messages</i> on page 25 for more information. | -      | H            | 0             |
| 2     | type       | See <i>Table 35: Fix Types</i> on the next page |              | Fix type   | Enum   | 4            | H             |
| 3     | param1     | See <i>Table 34: FIX Parameters</i> below       |              | Parameter 1  | Double | 8            | H + 4         |
| 4     | param2     |   |              | Parameter 2  | Double | 8            | H + 12        |
| 5     | param3     |   |              | Parameter 3  | Double | 8            | H + 20        |

**Table 34: FIX Parameters**

| ASCII Type Name | Parameter 1 | Parameter 2 | Parameter 3 |
|-----------------|-------------|-------------|-------------|
| AUTO            | Not used    | Not used    | Not used    |

| ASCII Type Name | Parameter 1  | Parameter 2   | Parameter 3  |
|-----------------|--|---|--|
| HEIGHT          | Default MSL height <sup>1</sup><br>(-1000 to 20000000 m)                                     | Not used  | Not used   |
| NONE            | Not used   | Not used  | Not used   |
| POSITION        | Lat (-90 to 90 degrees)<br>where a '-' sign denotes<br>south and a '+' sign denotes<br>north | Lon (-360 to 360 degrees)<br>where a '-' sign denotes west<br>and a '+' sign denotes east | Default MSL height <sup>1</sup><br>(-1000 to 20000000 m) |



For a discussion on height, refer to [An Introduction to GNSS](#) available on our website.

**Table 35: Fix Types**

| ASCII Name | Binary Value | Description  |
|------------|--------------|--|
| NONE       | 0            | Unfix. Clears any previous FIX commands  |
| AUTO       | 1            | Configures the receiver to fix the height at the last calculated value if the number of satellites available is insufficient for a 3-D solution. This provides a 2-D solution. Height calculation resumes when the number of satellites available allows a 3-D solution  |
| HEIGHT     | 2            | Configures the receiver in 2-D mode with its height constrained to a given value. This command is used mainly in marine applications where height in relation to mean sea level may be considered to be approximately constant. The height entered using this command is referenced to the mean sea level, see the <b>BESTPOS</b> log on page 416 (is in metres). The receiver is capable of receiving and applying differential corrections from a base station while fix height is in effect. The fix height command overrides any previous <b>FIX HEIGHT</b> or <b>FIX POSITION</b> command.<br><br><b>Note:</b> This command only affects pseudorange corrections and solutions. |

<sup>1</sup>See also Note #4 above.



| ASCII Name | Binary Value | Description   |
|------------|--------------|---|
| POSITION   | 3            | <p>Configures the receiver with its position fixed. This command is used when it is necessary to generate differential corrections.</p> <p>For both pseudorange and differential corrections, this command must be properly initialized before the receiver can operate as a GNSS base station. Once initialized, the receiver computes differential corrections for each satellite being tracked. The computed differential corrections can then be output to rover stations using the RTCMV3 differential corrections data log format. See the <a href="#">OEM7 Installation and Operation User Manual</a> for information about using the receiver for differential applications.</p> <p>The values entered into the fix position command should reflect the precise position of the base station antenna phase center. Any errors in the fix position coordinates directly bias the corrections calculated by the base receiver.</p> <p>The receiver performs all internal computations based on WGS84 and the <b>DATUM</b> command (see page 114) is defaulted as such. The datum in which you choose to operate (by changing the <b>DATUM</b> command (see page 114)) is internally converted to and from WGS84. Therefore, all differential corrections are based on WGS84, regardless of your operating datum.</p> <p>The <b>FIX POSITION</b> command overrides any previous <b>FIX HEIGHT</b> or <b>FIX POSITION</b> command settings.</p> |

## 2.46 FIXPOSDATUM

### *Sets position in a specified datum*

**Platform:** OEM719, OEM729, OEM7500, OEM7700, OEM7720, PwrPak7, HxGN PIM7500

This command is used to set the FIX position in a specific datum. The input position is transformed into the same datum as that in the receiver's current setting. The **FIX** command (see page 158) is then issued internally with the **FIXPOSDATUM** command values. It is the **FIX** command (see page 158) that appears in the **RXCONFIG** log (see page 732). If the **FIX** command (see page 158) or the **FIXPOSDATUM** command are used, their newest values overwrite the internal FIX values.

**Message ID:** 761

**Abbreviated ASCII Syntax:**

```
FIXPOSDATUM datum lat lon height
```

**Factory Default:**

```
fix none
```

**ASCII Example:**

```
FIXPOSDATUM USER 51.11633810554 -114.03839550586 1048.2343
```



Use the **FIXPOSDATUM** command in a survey to fix the position with values from another known datum, rather than manually transforming them into WGS84.

| Field | Field Type          | ASCII Value  | Binary Value | Description  | Format | Binary Bytes | Binary Offset |
|-------|---------------------|--|--------------|--|--------|--------------|---------------|
| 1     | FIXPOS DATUM header | -  | -            | Command header. See <i>Messages</i> on page 25 for more information. | -      | H            | 0             |
| 2     | datum               | See Table 28: <i>Datum Transformation Parameters</i> on page 116 |              | Datum ID   | Enum   | 4            | H             |
| 3     | lat                 | ±90  |              | Latitude (degrees)   | Double | 8            | H+4           |
| 4     | lon                 | ±360   |              | Longitude (degrees)  | Double | 8            | H+12          |
| 5     | height              | -1000 to 20000000  |              | Mean sea level (MSL) height (m)                                      | Double | 8            | H+20          |



For a discussion on height, refer to [An Introduction to GNSS](#) available on our website.

## 2.47 FORCEGLOL2CODE

**Forces receiver to track GLONASS satellite L2 P or L2 C/A code**

**Platform: OEM719, OEM729, OEM7500, OEM7700, OEM7720, PwrPak7, HxGN PIM7500**

This command is used to force the receiver to track GLONASS satellite L2 P-code or L2 C/A code. This command has no effect if the channel configuration contains both GLONASS L2 P and L2 C/A channels.

**Message ID: 1217**

**Abbreviated ASCII Syntax:**

```
FORCEGLOL2CODE L2type
```

**Factory Default:**

```
FORCEGLOL2CODE default
```

**ASCII Example:**

```
FORCEGLOL2CODE p
```

| Field | Field Type             | ASCII Value                                     | Binary Value | Description  | Format | Binary Bytes | Binary Offset |
|-------|------------------------|---|--------------|--|--------|--------------|---------------|
| 1     | FORCEGLO L2CODE header | -   | -            | Command header. See <i>Messages</i> on page 25 for more information. | -      | H            | 0             |
| 2     | L2type                 | See <i>Table 36: GLONASS L2 Code Type</i> below |              | GLONASS L2 code type   | Enum   | 4            | H             |

**Table 36: GLONASS L2 Code Type**

| Binary | ASCII   | Description                               |
|--------|---------|---|
| 1      | P       | L2 P-code or L2 Precise code              |
| 2      | C       | L2 C/A code or L2 Coarse/Acquisition code |
| 3      | DEFAULT | Set to channel default                    |

The following table lists which L2 signal is tracked based on the channel configuration and the setting used for the L2type parameter.

**Table 37: Signals Tracked – Channel Configuration and L2type Option**

| Channel Configuration for L2 Signal | L2type Setting |      |         |
|-------------------------------------|----------------|------|---------|
|                                     | P              | C    | DEFAULT |
| L2                                  | P              | C    | P       |
| L2C                                 | P              | C    | C       |
| L2PL2C                              | Both           | Both | Both    |

## 2.48 FORCEGPSL2CODE

**Forces receiver to track GPS satellite L2 P or L2C code**

**Platform: OEM719, OEM729, OEM7500, OEM7700, OEM7720, PwrPak7, HxGN PIM7500**

This command is used to force the receiver to track GPS L2 P-code or L2C code. AUTO tells the receiver to use L2C code type if available and L2 P-code if L2C code is not available. This command has no effect if the channel configuration contains both GPS L2 P and L2 C channels.

**Message ID: 796**

**Abbreviated ASCII Syntax:**

```
FORCEGPSL2CODE L2type
```

**Factory Default:**

```
FORCEGPSL2CODE default
```

**ASCII Example:**

```
FORCEGPSL2CODE p
```

| Field | Field Type             | ASCII Value                                 | Binary Value | Description  | Format | Binary Bytes | Binary Offset |
|-------|------------------------|---|--------------|--|--------|--------------|---------------|
| 1     | FORCEGPS L2CODE header | -   | -            | Command header. See <i>Messages</i> on page 25 for more information. | -      | H            | 0             |
| 2     | L2type                 | See <i>Table 38: GPS L2 Code Type</i> below |              | GPS L2 code type   | Enum   | 4            | H             |

**Table 38: GPS L2 Code Type**

| Binary | ASCII   | Description   |
|--------|---------|---|
| 0      | AUTO    | Receiver uses the L2C if available and L2 P otherwise. An exception is when the receiver is doing RTK positioning. In that case, AUTO changes the L2 code type being tracked to match the L2 code type found in the base station corrections, which ensures the greatest number of satellites are used in the solution. |
| 1      | P       | L2 P-code or L2 Precise code  |
| 2      | C       | L2C code or L2 Civilian code  |
| 3      | DEFAULT | Set to channel default  |

The following table lists which L2 signal is tracked based on the channel configuration and the setting used for the L2type parameter.

**Table 39: Signals Tracked – Channel Configuration and L2type Option**

| Channel Configuration for L2 Signal | L2type Setting                 |      |      |                                |
|-------------------------------------|--------------------------------|------|------|--------------------------------|
|                                     | Auto                           | P    | C    | DEFAULT                        |
| L2                                  | C if available, P(Y) otherwise | P(Y) | C    | P(Y)                           |
| L2C                                 | C if available, P(Y) otherwise | P(Y) | C    | C                              |
| L2P                                 | C if available, P(Y) otherwise | P(Y) | C    | P(Y)                           |
| L2AUTO                              | C if available, P(Y) otherwise | P(Y) | C    | C if available, P(Y) otherwise |
| L2PL2C                              | Both                           | Both | Both | Both                           |

## 2.49 FREQUENCYOUT

### *Sets output pulse train available on VARF*

**Platform: OEM719, OEM729, OEM7500, OEM7700, OEM7720, PwrPak7, HxGN PIM7500**

This command is used to set the output pulse train available on the Variable Frequency (VARF) or EVENT\_OUT1 pin. The output waveform is coherent with the 1PPS output, see the usage note and *Figure 4: Pulse Width and 1PPS Coherency* on the next page.



If the **CLOCKADJUST** command (see page 101) command is ENABLED and the receiver is configured to use an external reference frequency (set in the **EXTERNALCLOCK** command (see page 144) for an external clock - TCXO, OCXO, RUBIDIUM, CESIUM, or USER), then the clock steering process takes over the VARF output pins and may conflict with a previously entered **FREQUENCYOUT** command.



*Figure 4: Pulse Width and 1PPS Coherency* on the next page shows how the chosen pulse width is frequency locked but not necessarily phase locked when using ENABLE option. To synchronize the phase, use ENABLESYNC option.



The EVENTOUT outputs cannot synchronize with GPS time until the receiver reaches FINESTEERING time status. As the receiver transitions to GPS time, there may be additional, unexpected pulses on the EVENTOUT signals.

**Message ID: 232**

#### **Abbreviated ASCII Syntax:**

```
FREQUENCYOUT [switch] [pulsewidth] [period]
```

#### **Factory Default:**

```
FREQUENCYOUT disable
```

#### **ASCII Example:**

```
FREQUENCYOUT ENABLE 2 4
```

This example generates a 50% duty cycle 25 MHz square wave.

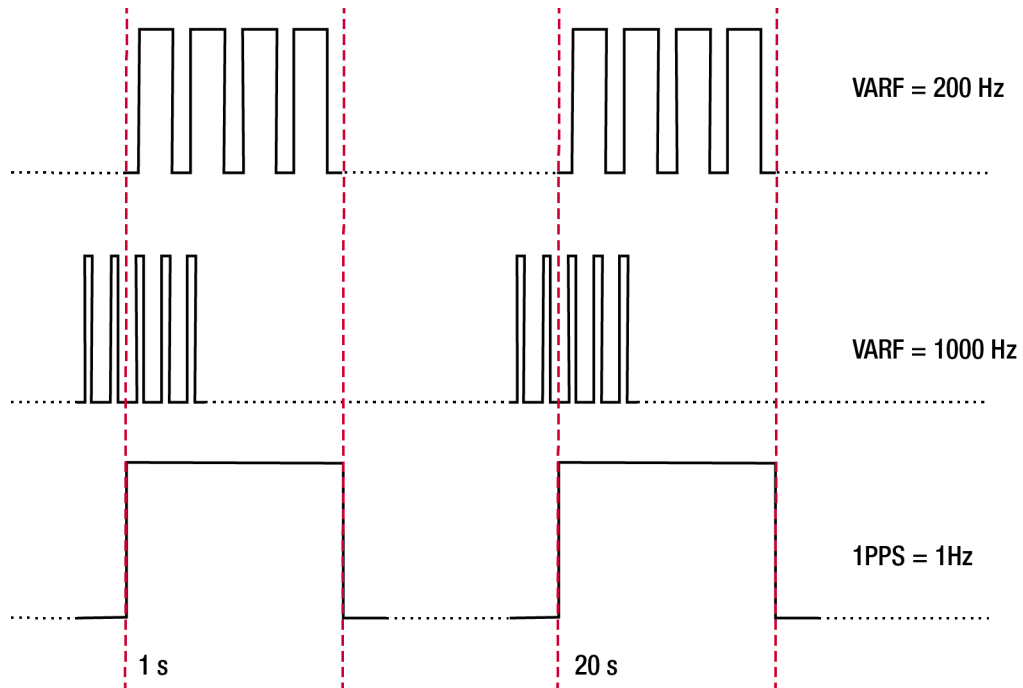
**Figure 4: Pulse Width and 1PPS Coherency**

When using ENABLE option, the VARF and 1PPS are not necessarily in phase as described in *Figure 4: Pulse Width and 1PPS Coherency* above. To align the phase of the VARF with the 1PPS, use the ENABLESYNC option and the VARF phase will be synchronized to the leading edge of the 1PPS pulse. Note that if the VARF and 1PPS frequencies are not even multiples of each other, this may cause the VARF to have a shorter cycle pulse prior to each 1PPS pulse. 1PPS is not affected.

| Field | Field Type          | ASCII Value | Binary Value | Description  | Format | Binary Bytes | Binary Offset |
|-------|---------------------|-------------|--------------|--|--------|--------------|---------------|
| 1     | FREQUENCYOUT header | -           | -            | Command header. See <i>Messages</i> on page 25 for more information.               | -      | H            | 0             |
| 2     | switch              | DISABLE     | 0            | Disable causes the output to be fixed low (if NONE specified, defaults to DISABLE) | Enum   | 4            | H             |
|       |                     | ENABLE      | 1            | Enables customized frequency output  |        |              |               |
|       |                     | ENABLE SYNC | 2            | Enable customized frequency output synchronized to PPS                             |        |              |               |



| Field | Field Type | ASCII Value       | Binary Value | Description  | Format | Binary Bytes | Binary Offset |
|-------|------------|-------------------|--------------|--|--------|--------------|---------------|
| 3     | pulsewidth | (0 to 1073741823) |              | Number of 10 ns steps for which the output is high.<br><br>Duty cycle = pulsewidth / period. If pulsewidth is greater than or equal to the period, the output is a high DC signal. If pulsewidth is 1/2 the period, then the output is a square wave (default = 0) | Ulong  | 4            | H+4           |
| 4     | period     | (0 to 1073741823) |              | Signal period in 10 ns steps.<br><br>Frequency Output = 100,000,000 / Period (default = 0)   | Ulong  | 4            | H+8           |

## 2.50 FRESET

### *Clears selected data from NVM and reset*

**Platform: OEM719, OEM729, OEM7500, OEM7700, OEM7720, PwrPak7, HxGN PIM7500**

This command is used to clear data which is stored in non-volatile memory. Such data includes the almanac, ephemeris, and any user specific configurations. The commands, ephemeris, almanac, and L-Band related data, excluding the subscription information, can be cleared by using the STANDARD target. The receiver is forced to reset.



**FRESET STANDARD** (which is also the default) causes most commands, ephemeris, GNSS and almanac data previously saved to NVM to be erased.



The **FRESET STANDARD** command will erase all user settings. You should know your configuration (by requesting the **RXCONFIG** log on page 732) and be able to reconfigure the receiver before you send the **FRESET** command.

**Message ID: 20**

**Abbreviated ASCII Syntax:**

```
FRESET [target]
```

**Input Example:**

```
FRESET COMMAND
```

| Field | Field Type    | ASCII Value   | Binary Value | Description  | Format | Binary Bytes | Binary Offset |
|-------|---------------|---|--------------|--|--------|--------------|---------------|
| 1     | FRESET header | -   | -            | Command header. See <i>Messages</i> on page 25 for more information. | -      | H            | 0             |
| 2     | target        | See <i>Table 40: FRESET Target</i> on the next page |              | What data is to be reset by the receiver (default = STANDARD)        | Enum   | 4            | H             |



If you are receiving no data or random data from your receiver, try the following before contacting NovAtel:

- Verify that the receiver is tracking satellites by logging the **TRACKSTAT** log (see page 826) and checking that the receiver is tracking at least four satellites.
- Check the integrity and connectivity of power and data cables
- Verify the baud rate settings of the receiver and terminal device (your PC, data logger or laptop)
- Switch COM ports
- Issue the **FRESET** command.

**Table 40: FRESET Target**

| Binary | ASCII          | Description  |
|--------|----------------|--|
| 0      | STANDARD       | Resets commands (except <b>CLOCKCALIBRATION</b> and <b>MODEL</b> ), ephemeris and almanac (default).<br>Also resets all L-Band related data except for the subscription information.<br>Does not reset the Ethernet settings or stored Profile configurations. |
| 1      | COMMAND        | Resets the stored commands (saved configuration)   |
| 2      | GPSALMANAC     | Resets the stored GPS almanac  |
| 3      | GPSEPHEM       | Resets the stored GPS ephemeris  |
| 4      | GLOEPHEM       | Resets the stored GLONASS ephemeris  |
| 5      | MODEL          | Resets the currently selected model  |
| 10     | USERDATA       | Resets the user data saved using the <b>NVMUSERDATA</b> command (see page 248)   |
| 11     | CLKCALIBRATION | Resets the parameters entered using the <b>CLOCKCALIBRATE</b> command (see page 103)   |
| 20     | SBASALMANAC    | Resets the stored SBAS almanac   |
| 21     | LAST_POSITION  | Resets the position using the last stored position   |
| 31     | GLOALMANAC     | Resets the stored GLONASS almanac  |
| 39     | GALFNAV_EPH    | Resets the stored GALFNAV ephemeris  |
| 40     | GALINAV_EPH    | Resets the stored GALINAV ephemeris  |
| 45     | GALFNAV_ALM    | Resets the stored GALFNAV almanac  |

---

| <b>Binary</b> | <b>ASCII</b>           | <b>Description</b>   |
|---------------|------------------------|--|
| 46            | GALINAV_ALM            | Resets the stored GALINAV almanac                                    |
| 52            | PROFILEINFO            | Resets the stored profile configurations                             |
| 54            | QZSSALMANAC            | Resets the QZSS almanac  |
| 55            | QZSSEPHEMERIS          | Resets the QZSS ephemeris  |
| 57            | BDSALMANAC             | Resets the BeiDou almanac  |
| 58            | BDSEPHEMERIS           | Resets the BeiDou ephemeris  |
| 60            | USER_ACCOUNTS          | Resets the admin password to the default (the receiver PSN)          |
| 64            | ETHERNET               | Resets the stored Ethernet settings                                  |
| 85            | SRTK_<br>SUBSCRIPTIONS | Resets the Secure RTK Subscription data stored on the rover receiver |
| 87            | NAVICEPHEMERIS         | Resets the NavIC ephemeris   |
| 88            | NAVICALMANAC           | Resets the NavIC almanac   |

## 2.51 GALECUTOFF

### *Sets elevation cut-off angle for Galileo satellites*

**Platform: OEM719, OEM729, OEM7500, OEM7700, OEM7720, PwrPak7, HxGN PIM7500**

This command is used to set the elevation cut-off angle for tracked Galileo satellites. The receiver does not start automatically searching for a satellite until it rises above the cut-off angle (when satellite position is known). Tracked satellites that fall below the cut-off angle are no longer tracked unless they were manually assigned (see the **ASSIGN** command on page 66).

In either case, satellites below the GALECUTOFF angle are eliminated from the internal position and clock offset solution computations.

This command permits a negative cut-off angle and can be used in the following situations:

- The antenna is at a high altitude and thus look below the local horizon
- Satellites are visible below the horizon due to atmospheric refraction



Care must be taken when using **GALECUTOFF** because the signals from lower elevation satellites are traveling through more atmosphere and are therefore degraded. Use of satellites below 5 degrees is not recommended.



Use the **ELEVATIONCUTOFF** command (see page 134) to set the cut-off angle for any system.



For dual antenna receivers, this command applies to both the primary and secondary antennas.

**Message ID: 1114**

**Abbreviated ASCII Syntax:**

```
GALECUTOFF angle
```

**Factory Default:**

```
GALECUTOFF 5.0
```

**ASCII Example:**

```
GALECUTOFF 10.0
```

| Field | Field Type        | ASCII Value   | Binary Value | Description  | Format | Binary Bytes | Binary Offset |
|-------|-------------------|---------------|--------------|--|--------|--------------|---------------|
| 1     | GALECUTOFF header | -             | -            | Command header. See <i>Messages</i> on page 25 for more information. | -      | H            | 0             |
| 2     | angle             | ±90.0 degrees |              | Elevation cut-off angle relative to horizon                          | Float  | 4            | H             |

## 2.52 GENERATEALIGNCORRECTIONS

### Configure ALIGN Master

**Platform: OEM719, OEM729, OEM7500, OEM7700, OEM7720, PwrPak7, HxGN PIM7500**

This command is used to configure the ALIGN Master and starts sending out ALIGN corrections through the specified port. This command is like sending the following commands to the Master, assuming the use of a serial port and default ALIGN corrections:

```
unlogall [port]
fix none
movingbasestation enable
interfacemode [port] novatel rtca
serialconfig [port] [baud] N 8 1 N ON
log [port] rtcaobs3 ontime [rate = 1/ obsregrate]
log [port] rtcarefext ontime [rate = 1/ refextregrate]
```

**Message ID: 1349**

#### Abbreviated ASCII Syntax:

```
GENERATEALIGNCORRECTIONS port [baud] [obsregrate] [refextregrate]
[interfacemode]
```

#### ASCII Example:

```
GENERATEALIGNCORRECTIONS COM2 230400 10 10
```

| Field | Field Type                       | ASCII Value  | Binary Value | Description  | Format | Binary Bytes | Binary Offset |
|-------|----------------------------------|--|--------------|--|--------|--------------|---------------|
| 1     | GENERATEALIGN CORRECTIONS header | -  | -            | Command header. See <i>Messages</i> on page 25 for more information. | -      | H            | 0             |
| 2     | port                             | See <i>Table 31: Communications Port Identifiers</i> on page 130 |              | Port identifier (default = THISPORT)                                 | Enum   | 4            | H             |
| 3     | baud                             | 9600, 19200, 38400, 57600, 115200, 230400 or 460800              |              | Communication baud rate (bps) (default = 9600)                       | Ulong  | 4            | H+4           |
| 4     | obsregrate                       | 1, 2, 4, 5, 10, 20, 50 or 100                                    |              | RTCAOBS3 data rate in Hz (default = 1)                               | Ulong  | 4            | H+8           |

| Field | Field Type    | ASCII Value                      | Binary Value | Description                                | Format | Binary Bytes | Binary Offset |
|-------|---------------|----------------------------------|--------------|--|--------|--------------|---------------|
| 5     | refextreqrate | 0, 1, 2, 4, 5, 10, 20, 50 or 100 |              | RTCAREFEXT data rate in Hz (default = 1)   | Ulong  | 4            | H+12          |
| 6     | interfacemode | RTCA                             | 3            | Correction interface mode (default = RTCA) | Enum   | 4            | H+16          |
|       |               | NOVATELX                         | 35           |  |        |              |               |



## 2.53 GENERATEDIFFCORRECTIONS

*Sends a preconfigured set of differential corrections*

**Platform:** OEM719, OEM729, OEM7500, OEM7700, OEM7720, PwrPak7, HxGN PIM7500

This command is used to configure the receiver to send a preconfigured set of differential pseudorange corrections.

**Message ID:** 1296

**Abbreviated ASCII Syntax:**

```
GENERATEDIFFCORRECTIONS mode port
```

**ASCII Example:**

```
GENERATEDIFFCORRECTIONS rtcn com2
```

Preconfigured set of differential corrections sent when RTCM:

```
RTCM1 ontime 1
RTCM31 ontime 1
RTCM3 ontime 10
```

Preconfigured set of differential corrections sent when RTCA:

```
RTCA1 ontime 1
RTCAREF ontime 10
```

| Field | Field Type                     | ASCII Value   | Binary Value | Description   | Format | Binary Bytes | Binary Offset |
|-------|--------------------------------|---|--------------|---|--------|--------------|---------------|
| 1     | GENERATEDIFFCORRECTIONS header | -   | -            | Command header. See <i>Messages</i> on page 25 for more information.                                | -      | H            | 0             |
| 2     | mode                           | RTCM  | 2            | Serial port interface mode identifier. See <i>Table 41: Serial Port Interface Modes</i> on page 192 | Enum   | 4            | H             |
|       |                                | RTCA  | 3            |   |        |              |               |
| 3     | port                           | See <i>Table 58: COM Port Identifiers</i> on page 327 |              | Port to configure   | Enum   | 4            | H+4           |

## 2.54 GENERATERTKCORRECTIONS

*Sends a preconfigured set of RTK corrections*

**Platform: OEM719, OEM729, OEM7500, OEM7700, OEM7720, PwrPak7, HxGN PIM7500**

This command is used to configure the receiver to send a preconfigured set of RTK (carrier phase) corrections.

**Message ID: 1260**

**Abbreviated ASCII Syntax:**

```
GENERATERTKCORRECTIONS mode port
```

**ASCII Example:**

```
GENERATERTKCORRECTIONS rtcmv3 com2
```

Preconfigured set of differential corrections sent when RTCM:

```
RTCM1819 ontime 1
RTCM3 ontime 10
RTCM22 ontime 10
RTCM23 ontime 60
RTCM24 ontime 60
```

Preconfigured set of differential corrections sent when RTCMV3:

```
RTCM1004 ontime 1
RTCM1012 ontime 1
RTCM1006 ontime 10
RTCM1008 ontime 10
RTCM1033 ontime 10
```

Preconfigured set of differential corrections sent when RTCA:

```
RTCAOBS2 ontime 1
RTCAREF ontime 10
```

Preconfigured set of differential corrections sent when CMR:

```
CMROBS ontime 1
CMRGLOBS ontime 1
CMRREF ontime 10
```

Preconfigured set of differential corrections sent when NOVATELX COM2:

```
NOVATELXOBS ontime 1
```

| Field | Field Type                           | ASCII Value  | Binary Value | Description   | Format | Binary Bytes | Binary Offset |
|-------|--------------------------------------|--|--------------|---|--------|--------------|---------------|
| 1     | GENERATERTK<br>CORRECTIONS<br>header | -  | -            | Command header. See <i>Messages</i> on page 25 for more information.  | -      | H            | 0             |
| 2     | mode                                 | RTCM   | 2            | Serial port interface mode identifier. For more information, see <i>Table 41: Serial Port Interface Modes</i> on page 192 | Enum   | 4            | H             |
|       |                                      | RTCA   | 3            |   |        |              |               |
|       |                                      | CMR  | 4            |   |        |              |               |
|       |                                      | RTCMV3   | 14           |   |        |              |               |
|       |                                      | NOVATELX   | 35           |   |        |              |               |
| 3     | port                                 | See <i>Table 58: COM Port Identifiers</i> on page 327) |              | Port to configure   | Enum   | 4            | H+4           |

## 2.55 GGAQUALITY

*Customizes the GPGGA GPS quality indicator*

**Platform:** OEM719, OEM729, OEM7500, OEM7700, OEM7720, PwrPak7, HxGN PIM7500

This command is used to customize the NMEA GPGGA GPS quality indicator. See also the **GPGGA** log on page 497.

**Message ID:** 691

**Abbreviated ASCII Syntax:**

```
GGAQUALITY #entries pos_type quality
```

**Input Example 1:**

```
GGAQUALITY 1 waas 2
```

Makes the WAAS solution type show 2 as the quality indicator.

**Input Example 2:**

```
GGAQUALITY 2 waas 2 NARROW_FLOAT 3
```

Makes the WAAS solution type show 2 and the NARROW\_FLOAT solution type show 3, as their quality indicators.

**Input Example 3:**

```
GGAQUALITY 0
```

Sets all the quality indicators back to the default.



Some solution types, see *Table 74: Position or Velocity Type* on page 420, share a quality indicator. For example, converged PPP and NARROW\_FLOAT all share an indicator of 5. This command can be used to customize an application to have unique indicators for each solution type. Sets all the quality indicators back to the default. Refer to *Table 97: GPS Quality Indicators* on page 499.

| Field | Field Type        | ASCII Value | Binary Value | Description  | Format | Binary Bytes | Binary Offset |
|-------|-------------------|-------------|--------------|--|--------|--------------|---------------|
| 1     | GGAQUALITY header | -           | -            | Command header. See <i>Messages</i> on page 25 for more information. | -      | H            | 0             |
| 2     | #entries          | 0-20        |              | The number of position types that are being remapped (20 max)        | Ulong  | 4            | H             |

| Field | Field Type  | ASCII Value  | Binary Value | Description   | Format   | Binary Bytes | Binary Offset |
|-------|---|--|--------------|---|----------|--------------|---------------|
| 3     | pos_type  | See <i>Table 74: Position or Velocity Type</i> on page 420 |              | The position type that is being remapped  | Enum     | 4            | H+4           |
| 4     | quality   | See <i>Table 97: GPS Quality Indicators</i> on page 499    |              | The remapped quality indicator value that will appear in the GPGGA log for this position type | Ulong    | 4            | H+8           |
| ...   | Next solution type and quality indicator set, if applicable |  |              |   | Variable |              |               |

## 2.56 GLIDEINITIALIZATIONPERIOD

*Configures the GLIDE initialization period*

**Platform:** OEM719, OEM729, OEM7500, OEM7700, OEM7720, PwrPak7, HxGN PIM7500

This command sets the initialization period for Relative PDP (GLIDE) when pseudorange measurements are used more heavily. During the initialization period, the PDP output position is not as smooth as during full GLIDE operation, but it helps to get better absolute accuracy at the start. The longer this period is, the better the absolute accuracy that can be attained. The maximum period that can be set through **GLIDEINITIALIZATIONPERIOD** is 1200 seconds.

**Message ID: 1760**

**Abbreviated ASCII Syntax:**

```
GLIDEINITIALIZATIONPERIOD initialization
```

**Factory Default:**

```
GLIDEINITIALIZATIONPERIOD 300
```

**ASCII Example:**

```
GLIDEINITIALIZATIONPERIOD 100
```

| Field | Field Type                        | ASCII Value | Binary Value | Description  | Binary Format | Binary Bytes | Binary Offset |
|-------|-----------------------------------|-------------|--------------|--|---------------|--------------|---------------|
| 1     | GLIDEINITIALIZATION PERIOD header | -           | -            | Command header. See <i>Messages</i> on page 25 for more information. | -             | H            | 0             |
| 2     | initialization                    | 0 -1200 s   |              | Initialization period for GLIDE in seconds                           | Double        | 8            | H             |

## 2.57 GLOECUTOFF

### *Sets GLONASS satellite elevation cut-off*

**Platform: OEM719, OEM729, OEM7500, OEM7700, OEM7720, PwrPak7, HxGN PIM7500**

This command is used to set the elevation cut-off angle for tracked GLONASS satellites. The receiver does not start automatically searching for a satellite until it rises above the cut-off angle (when satellite position is known). Tracked satellites that fall below the cut-off angle are no longer tracked unless they were manually assigned (see the **ASSIGN** command on page 66).

In either case, satellites below the GLOECUTOFF angle are eliminated from the internal position and clock offset solution computations.

This command permits a negative cut-off angle and can be used in the following situations:

- The antenna is at a high altitude and can look below the local horizon
- Satellites are visible below the horizon due to atmospheric refraction



Care must be taken when using **GLOECUTOFF** because the signals from lower elevation satellites are traveling through more atmosphere and are therefore degraded. Use of satellites below 5 degrees is not recommended.



Use the **ELEVATIONCUTOFF** command (see page 134) to set the cut-off angle for any system.



For dual antenna receivers, this command applies to both the primary and secondary antennas.

**Message ID: 735**

#### **Abbreviated ASCII Syntax:**

```
GLOECUTOFF angle
```

#### **Factory Default:**

```
GLOECUTOFF 5.0
```

#### **ASCII Example:**

```
GLOECUTOFF 0
```

| Field | Field Type        | ASCII Value   | Binary Value | Description  | Format | Binary Bytes | Binary Offset |
|-------|-------------------|---------------|--------------|--|--------|--------------|---------------|
| 1     | GLOECUTOFF header | -             | -            | Command header. See <i>Messages</i> on page 25 for more information. | -      | H            | 0             |
| 2     | angle             | ±90.0 degrees |              | Elevation cut-off angle relative to horizon                          | Float  | 4            | H             |



## 2.58 HDTOUTTHRESHOLD

### *Controls GPHDT log output*

**Platform:** OEM719, OEM729, OEM7500, OEM7700, OEM7720, PwrPak7, HxGN PIM7500

This command is used to control the output of the NMEA **GPHDT** log (see page 512). It sets a heading standard deviation threshold. Only heading information with a standard deviation less than this threshold can be output into a GPHDT message.

**Message ID:** 1062

**Abbreviated ASCII Syntax:**

```
HDTOUTTHRESHOLD thresh
```

**Factory Default:**

```
HDTOUTTHRESHOLD 2.0
```

**ASCII Example:**

```
HDTOUTTHRESHOLD 12.0
```

| Field | Field Type             | ASCII Value | Binary Value | Description  | Format | Binary Bytes | Binary Offset |
|-------|------------------------|-------------|--------------|--|--------|--------------|---------------|
| 1     | HDTOUTTHRESHOLD header | -           | -            | Command header. See <i>Messages</i> on page 25 for more information. | -      | H            | 0             |
| 2     | thresh                 | 0.0 - 180.0 |              | Heading standard deviation threshold (degrees)                       | Float  | 4            | H             |

## 2.59 HEADINGOFFSET

*Adds heading and pitch offset values*

**Platform:** OEM719, OEM729, OEM7500, OEM7700, OEM7720, PwrPak7, HxGN PIM7500

This command is used to add an offset in the heading and pitch values of the **HEADING2** log (see page 526) and **GPHDT** log (see page 512).

**Message ID:** 1082

**Abbreviated ASCII Syntax:**

```
HEADINGOFFSET headingoffsetindeg [pitchoffsetindeg]
```

**Factory Default:**

```
HEADINGOFFSET 0 0
```

**ASCII Example:**

```
HEADINGOFFSET 2 -1
```

| Field | Field Type           | ASCII Value    | Binary Value | Description  | Format | Binary Bytes | Binary Offset |
|-------|----------------------|----------------|--------------|--|--------|--------------|---------------|
| 1     | HEADINGOFFSET header | -              | -            | Command header. See <i>Messages</i> on page 25 for more information. | -      | H            | 0             |
| 2     | headingoffsetindeg   | -180.0 - 180.0 |              | Offset added to heading output (degrees). Default=0                  | Float  | 4            | H             |
| 3     | pitchoffsetindeg     | -90.0 - 90.0   |              | Offset added to pitch output (degrees). Default=0                    | Float  | 4            | H+4           |

## 2.60 ICOMCONFIG

### *Configures IP virtual COM port*

**Platform: OEM729, OEM7700, OEM7720, PwrPak7**

This command is used for Ethernet set up and to configure the transport/application layer of the configuration.



Access to the ICOM ports can be restricted by turning on ICOM security using the **IPSERVICE** command (see page 198).

**Message ID: 1248**

#### Abbreviated ASCII Syntax:

```
ICOMCONFIG [port] protocol [endpoint[bindinterface]]
```

#### Factory Default:

```
ICOMCONFIG ICOM1 TCP :3001
ICOMCONFIG ICOM2 TCP :3002
ICOMCONFIG ICOM3 TCP :3003
ICOMCONFIG ICOM4 TCP :3004
ICOMCONFIG ICOM5 TCP :3005
ICOMCONFIG ICOM6 TCP :3006
ICOMCONFIG ICOM7 TCP :3007
```

#### ASCII Example:

```
ICOMCONFIG ICOM1 TCP :2000 All
```



Due to security concerns, configuring and enabling ICOM ports should only be done to receivers on a closed system, that is, board-to-board. NovAtel is not liable for any security breaches that may occur if not used on a closed system.

| Field | Field Type        | ASCII Value | Binary Value | Data Description   | Format | Binary Bytes | Binary Offset |
|-------|-------------------|-------------|--------------|--|--------|--------------|---------------|
| 1     | ICOMCONFIG Header | -           | -            | Command header. See <i>Messages</i> on page 25 for more information. | -      | H            | 0             |

| Field | Field Type    | ASCII Value   | Binary Value | Data Description   | Format         | Binary Bytes          | Binary Offset |
|-------|---------------|---|--------------|--|----------------|-----------------------|---------------|
| 2     | port          | THISPORT  | 6            | Name of the port (default = THISPORT).   | Enum           | 4                     | H             |
|       |               | ICOM1   | 23           |  |                |                       |               |
|       |               | ICOM2   | 24           |  |                |                       |               |
|       |               | ICOM3   | 25           |  |                |                       |               |
|       |               | ICOM4   | 29           |  |                |                       |               |
|       |               | ICOM5   | 46           |  |                |                       |               |
|       |               | ICOM6   | 47           |  |                |                       |               |
|       |               | ICOM7   | 48           |  |                |                       |               |
| 3     | protocol      | DISABLED  | 1            | Will disable the service   | Enum           | 4                     | H+4           |
|       |               | TCP   | 2            | Use Raw TCP  |                |                       |               |
|       |               | UDP   | 3            | Use Raw UDP  |                |                       |               |
| 4     | endpoint      | Host:Port<br>For example:<br>10.0.3.1:8000<br>mybase.com:3000 |              | Endpoint to wait on, or to connect to where host is a host name or IP address and port is the TCP/UDP port number. If host is blank, act as a server | String<br>[80] | variable <sup>1</sup> | H+8           |
| 5     | bindInterface | ALL (default)   | 1            | Not supported. Set to ALL for future compatibility.  | Enum           | 4                     | H+88          |

<sup>1</sup>In the binary case, each string field needs to be NULL terminated and additional bytes of padding added to maintain 4-byte alignment, up to the maximum defined by the string size. The next defined field starts immediately at the next 4-byte alignment following the NULL.

## 2.61 INTERFACEMODE

### *Sets receive or transmit modes for ports*

**Platform: OEM719, OEM729, OEM7500, OEM7700, OEM7720, PwrPak7, HxGN PIM7500**

This command is used to specify what type of data a particular port on the receiver can transmit and receive. The receive type tells the receiver what type of data to accept on the specified port. The transmit type tells the receiver what kind of data it can generate. For example, to accept RTCMV3 differential corrections, set the receive type on the port to RTCMV3.

It is also possible to disable or enable the generation or transmission of command responses for a particular port. Disabling of responses is important for applications where data is required in a specific form and the introduction of extra bytes may cause problems, i.e., RTCA, RTCM, RTCMV3 or CMR. Disabling a port prompt is also useful when the port is connected to a modem or other device that responds with data the RECEIVER does not recognize.



For applications running in specific interface modes, see *Table 41: Serial Port Interface Modes* on page 192, please set the appropriate interface modes before sending or receiving corrections. It is important that the port interface mode matches the data being received on that port. Mismatches between the interface mode and received data can result in CPU overloads.

When INTERFACEMODE port NONE NONE OFF is set, the specified port is disabled from interpreting any input or output data. Therefore, no commands or differential corrections are decoded by the specified port. When GENERIC is set for a port, it is also disabled but data can be passed through the disabled port and be output from an alternative port using the pass-through logs PASSCOM, PASSXCOM, PASSAUX and PASSUSB. See *PASSCOM, PASSXCOM, PASSAUX, PASSUSB, PASSETH1, PASSICOM, PASSNCOM* on page 609 for details on these logs along with the Operation chapter in the [OEM7 Installation and Operation User Manual](#) for information about pass-through logging. See also the **SERIALCONFIG** command on page 325.



If you intend to use the **SERIALCONFIG** command (see page 325), ensure you do so before the **INTERFACEMODE** command on each port. The **SERIALCONFIG** command (see page 325) can remove the **INTERFACEMODE** command setting if the baud rate is changed after the interface mode is set. You should also turn break detection off using the **SERIALCONFIG** command (see page 325) to stop the port from resetting because it is interpreting incoming bits as a break command. If such a reset happens, the Interface mode will be set back to the default NOVATEL mode for both input and output.

### 2.61.1 SPAN Systems

The INTERFACEMODE of the receiver is also configured for the serial port dedicated to the IMU. This mode changes automatically upon sending a **CONNECTIMU** command (see page 845) and the change is reflected when logging this command. This is normal operation.



When the **CONNECTIMU** command (see page 845) is used to configure the IMU connected to the receiver, the correct interface mode for the IMU port is automatically set. The IMU port should not be altered using the **INTERFACEMODE** command in normal operation. Doing so may result in the loss of IMU communication.

### Message ID: 3

#### Abbreviated ASCII Syntax:

```
INTERFACEMODE [port] rxtype txtype [responses]
```

#### Factory Default:

```
INTERFACEMODE COM1 NOVATEL NOVATEL ON
INTERFACEMODE COM2 NOVATEL NOVATEL ON
INTERFACEMODE COM3 NOVATEL NOVATEL ON
INTERFACEMODE AUX NOVATEL NOVATEL ON
INTERFACEMODE USB1 NOVATEL NOVATEL ON
INTERFACEMODE USB2 NOVATEL NOVATEL ON
INTERFACEMODE USB3 NOVATEL NOVATEL ON
INTERFACEMODE XCOM1 NOVATEL NOVATEL ON
INTERFACEMODE XCOM2 NOVATEL NOVATEL ON
INTERFACEMODE XCOM3 NOVATEL NOVATEL ON
INTERFACEMODE ICOM1 NOVATEL NOVATEL ON
INTERFACEMODE ICOM2 NOVATEL NOVATEL ON
INTERFACEMODE ICOM3 NOVATEL NOVATEL ON
INTERFACEMODE ICOM4 NOVATEL NOVATEL ON
INTERFACEMODE ICOM5 NOVATEL NOVATEL ON
INTERFACEMODE ICOM6 NOVATEL NOVATEL ON
INTERFACEMODE ICOM7 NOVATEL NOVATEL ON
INTERFACEMODE NCOM1 RTCMV3 NONE OFF
INTERFACEMODE NCOM2 RTCMV3 NONE OFF
INTERFACEMODE NCOM3 RTCMV3 NONE OFF
INTERFACEMODE CCOM1 NOVATELBINARY NOVATELBINARY ON
INTERFACEMODE CCOM2 NOVATELBINARY NOVATELBINARY ON
INTERFACEMODE CCOM3 AUTO NOVATEL OFF
INTERFACEMODE CCOM4 AUTO NOVATEL OFF
INTERFACEMODE CCOM5 AUTO NOVATEL OFF
INTERFACEMODE CCOM6 AUTO NOVATEL OFF
INTERFACEMODE SCOM1 NOVATEL NOVATEL ON
```

```

INTERFACEMODE SCOM2 NOVATEL NOVATEL ON
INTERFACEMODE SCOM3 NOVATEL NOVATEL ON
INTERFACEMODE SCOM4 NOVATEL NOVATEL ON

```

**ASCII Example 1:**

```
INTERFACEMODE COM1 RTCMV3 NOVATEL ON
```

**ASCII Example 2:**

```
INTERFACEMODE COM2 MRTCA NONE
```



Are NovAtel receivers compatible with others on the market?

All GNSS receivers output two solutions: position and time. The manner in which they output them makes each receiver unique. Most geodetic and survey grade receivers output the position in electronic form (typically RS-232), which makes them compatible with most computers and data loggers. All NovAtel receivers have this ability. However, each manufacturer has a unique way of formatting the messages. A NovAtel receiver is not directly compatible with a Trimble or Ashtech receiver (which are also incompatible with each other) unless everyone uses a standard data format.

However, there are several standard data formats available. For position and navigation output there is the NMEA format. Real-time differential corrections use RTCM or RTCA format. For receiver code and phase data RINEX format is often used. NovAtel and all other major manufacturers support these formats and can work together using them. The NovAtel format measurement logs can be converted to RINEX using the utilities provided in NovAtel Connect.

| Field | Field Type           | ASCII Value   | Binary Value | Description  | Format | Binary Bytes | Binary Offset |
|-------|----------------------|---|--------------|--|--------|--------------|---------------|
| 1     | INTERFACEMODE header | -   | -            | Command header. See <i>Messages</i> on page 25 for more information. | -      | H            | 0             |
| 2     | port                 | See <i>Table 31: Communications Port Identifiers</i> on page 130  |              | Serial port identifier (default = THISPORT)                          | Enum   | 4            | H             |
| 3     | rxtype               | See <i>Table 41: Serial Port Interface Modes</i> on the next page |              | Receive interface mode   | Enum   | 4            | H+4           |

| Field | Field Type | ASCII Value  | Binary Value | Description                                 | Format | Binary Bytes | Binary Offset |
|-------|------------|--|--------------|---|--------|--------------|---------------|
| 4     | txtype     | See Table 41:<br>Serial Port<br>Interface Modes<br>below |              | Transmit interface<br>mode                  | Enum   | 4            | H+8           |
| 5     | responses  | OFF  | 0            | Turn response<br>generation off             | Enum   | 4            | H+12          |
|       |            | ON   | 1            | Turn response<br>generation on<br>(default) |        |              |               |

**Table 41: Serial Port Interface Modes**

| Binary Value | ASCII Value | Description  |
|--------------|-------------|--|
| 0            | NONE        | The port accepts/generates nothing. The port is disabled   |
| 1            | NOVATEL     | The port accepts/generates NovAtel commands and logs   |
| 2            | RTCM        | The port accepts/generates RTCM corrections  |
| 3            | RTCA        | The port accepts/generates RTCA corrections  |
| 4            | CMR         | The port accepts/generates CMR corrections   |
| 5            | Reserved    |  |
| 6            | Reserved    |  |
| 7            | IMU         | This port supports communication with a NovAtel supported IMU.   |
| 8            | RTCMNOCR    | When RTCMNOCR is used as the <i>txtype</i> , the port generates RTCM corrections without the CR/LF appended.<br>When RTCMNOCR is used as the <i>rxtype</i> , the port accepts RTCM corrections with or without the CR/LF appended. |
| 9            | Reserved    |  |



| Binary Value | ASCII Value       | Description  |
|--------------|-------------------|--|
| 10           | TCOM1             | <p>INTERFACEMODE tunnel modes. To configure a full duplex tunnel, configure the baud rate on each port. Once a tunnel is established, the baud rate does not change. Special characters, such as a BREAK condition, do not route across the tunnel transparently and the serial port is altered, see the <b>SERIALCONFIG</b> command on page 325. Only serial ports may be in a tunnel configuration: COM1, COM2, COM3 or AUX may be used.</p> <p>For example, configure a tunnel at 115200 bps between COM1 and AUX:</p> <pre>SERIALCONFIG AUX 115200 SERIALCONFIG COM1 115200 INTERFACEMODE AUX TCOM1 NONE OFF INTERFACEMODE COM1 TAUX NONE OFF</pre> <p>The tunnel is fully configured to receive/transmit at a baud rate of 115200 bps</p> |
| 11           | TCOM2             |  |
| 12           | TCOM3             |  |
| 13           | TAUX <sup>1</sup> |  |
| 14           | RTCMV3            | The port accepts/generates RTCM Version 3.0 corrections  |
| 15           | NOVATELBINARY     | The port only accepts/generates binary messages. If an ASCII command is entered when the mode is set to binary only, the command is ignored. Only properly formatted binary messages are responded to and the response is a binary message   |
| 16-17        | Reserved          |  |
| 18           | GENERIC           | The port accepts/generates nothing. The <b>SEND</b> command (see page 322) or <b>SENDHEX</b> command (see page 324) from another port generate data on this port. Any incoming data on this port can be seen with PASSCOM logs on another port, see <b>PASSCOM</b> , <b>PASSXCOM</b> , <b>PASSAUX</b> , <b>PASSUSB</b> , <b>PASSETH1</b> , <b>PASSICOM</b> , <b>PASSNCOM</b> log on page 609   |
| 19           | IMARIMU           | This port supports communication with an iMAR IMU.   |
| 20           | MRTCA             | The port accepts/generates Modified Radio Technical Commission for Aeronautics (MRTCA) corrections   |
| 21-22        | Reserved          |  |
| 23           | KVHIMU            | This port supports communication with a KVH CG5100 IMU.  |
| 24-26        | Reserved          |  |

<sup>1</sup>Only available on specific models.

| Binary Value | ASCII Value      | Description  |
|--------------|------------------|--|
| 27           | AUTO             | For auto-detecting different RTK correction formats and incoming baud rate (over serial ports).<br>The change of baud rate will not appear when <b>SERIALCONFIG</b> is logged as this shows the saved baud rate for that port. |
| 28-34        | Reserved         |  |
| 35           | NOVATELX         | The port accepts/generates NOVATELX corrections  |
| 36-40        | Reserved         |  |
| 41           | KVH1750IMU       | This port supports communication with a KVH 17xx series IMU.   |
| 42-45        | Reserved         |  |
| 46           | TCCOM1           | CCOM1 Tunnel   |
| 47           | TCCOM2           | CCOM2 Tunnel   |
| 48           | TCCOM3           | CCOM3 Tunnel   |
| 49           | NOVATELMINBINARY | NovAtel binary message with a minimal header.<br>Only available for CCOM ports.  |
| 50           | TCCOM4           | CCOM4 Tunnel   |
| 51           | TCCOM5           | CCOM5 Tunnel   |
| 52           | TCCOM6           | CCOM6 Tunnel   |
| 53-57        | Reserved         |  |
| 60           | TSCOM1           | SCOM1 Tunnel   |
| 61           | TSCOM2           | SCOM2 Tunnel   |
| 62           | TSCOM3           | SCOM3 Tunnel   |
| 63           | TSCOM4           | SCOM4 Tunnel   |
| 64           | LUA              | Lua stdin/stdout/stderr.<br>Use the LUA PROMPT command to set this Interface Mode.   |

## 2.62 IONOCONDITION

### *Sets ionospheric condition*

**Platform: OEM719, OEM729, OEM7500, OEM7700, OEM7720, PwrPak7, HxGN PIM7500**

This command is used to change the level of ionosphere activity that is assumed by the RTK positioning algorithms.



Only advanced users should use this command.

**Message ID: 1215**

**Abbreviated ASCII Syntax:**

```
IONOCONDITION mode
```

**Factory Default:**

```
IONOCONDITION AUTO
```

**ASCII Example:**

```
IONOCONDITION normal
```

| Field | Field Type           | ASCII Value | Binary Value | Description   | Format | Binary Bytes | Binary Offset |
|-------|----------------------|-------------|--------------|---|--------|--------------|---------------|
| 1     | IONOCONDITION header | -           | -            | Command header. See <i>Messages</i> on page 25 for more information.      |        | H            |               |
| 2     | mode                 | quiet       | 0            | Receiver assumes a low level of ionosphere activity                       | Enum   | 4            | H             |
|       |                      | normal      | 1            | Receiver assumes a medium level of ionosphere activity                    |        |              |               |
|       |                      | disturbed   | 2            | Receiver assumes a high level of ionosphere activity                      |        |              |               |
|       |                      | AUTO        | 10           | Receiver monitors the ionosphere activity and adapts behavior accordingly |        |              |               |

## 2.63 IPCONFIG

### *Configures network IP settings*

**Platform: OEM729, OEM7700, OEM7720, PwrPak7**

This command is used to configure static/dynamic TCP/IP properties for the Ethernet connection.



In addition to configuring an IP address and netmask for the interface, this command also includes a gateway address.

**Message ID: 1243**

#### Abbreviated ASCII Syntax:

```
IPCONFIG [interface_name] address_mode [IP_address [netmask [gateway]]]
```

#### Factory Default:

```
IPCONFIG ETHA DHCP
```

#### ASCII Examples:

```
IPCONFIG ETHA STATIC 192.168.74.10 255.255.255.0 192.168.74.1
```

| Field | Field Type      | ASCII Value                                   | Binary Value | Description  | Format      | Binary Bytes          | Binary Offset |
|-------|-----------------|---|--------------|--|-------------|-----------------------|---------------|
| 1     | IPCONFIG Header | -   | -            | Command header. See <i>Messages</i> on page 25 for more information. | -           | H                     | 0             |
| 2     | interface name  | ETHA  | 2            | Name of the Ethernet interface (default = ETHA)                      | Enum        | 4                     | H             |
| 3     | address mode    | DHCP  | 1            | Use Dynamic IP address   | Enum        | 4                     | H+4           |
|       |                 | STATIC  | 2            | Use Static IP address  |             |                       |               |
| 4     | IP address      | ddd.ddd.ddd.ddd<br>(For example:<br>10.0.0.2) |              | IP Address-decimal dot notation                                      | String [16] | variable <sup>1</sup> | H+8           |

<sup>1</sup>In the binary case, each string field needs to be NULL terminated and additional bytes of padding added to maintain 4-byte alignment, up to the maximum defined by the string size. The next defined field starts immediately at the next 4-byte alignment following the NULL.

| Field | Field Type | ASCII Value  | Binary Value | Description                  | Format         | Binary Bytes  | Binary Offset |
|-------|------------|--|--------------|------------------------------|----------------|---------------|---------------|
| 5     | netmask    | ddd.ddd.ddd.ddd<br>(For example:<br>255.255.255.0) |              | Netmask-decimal dot notation | String<br>[16] | variable<br>1 | H+24          |
| 6     | gateway    | ddd.ddd.ddd.ddd<br>(For example:<br>10.0.0.1)      |              | Gateway-decimal dot notation | String<br>[16] | variable<br>1 | H+40          |

## 2.64 IPSERVICE

### *Configure availability of networks ports/services*

**Platform: OEM729, OEM7700, OEM7720, PwrPak7**

Use the **IPSERVICE** command to configure the availability of specific network ports/services. When disabled, the service does not accept incoming connections.



By default, the FTP Server is disabled.

**Message ID: 1575**

#### **Abbreviated ASCII Syntax:**

```
IPSERVICE IPService switch
```

#### **Factory Default:**

```
IPSERVICE WEB_SERVER DISABLE (OEM719)
```

```
IPSERVICE WEB_SERVER ENABLE (OEM729, OEM7700 and OEM7720)
```

```
IPSERVICE SECURE_ICOM DISABLE
```

#### **ASCII Example:**

```
IPSERVICE FTP_SERVER ENABLE
```

| Field | Field Type       | ASCII Value | Binary Value | Description  | Format | Binary Bytes | Binary Offset |
|-------|------------------|-------------|--------------|--|--------|--------------|---------------|
| 1     | IPSERVICE header | -           | -            | Command header. See <i>Messages</i> on page 25 for more information. | -      | H            | 0             |

| Field | Field Type | ASCII Value | Binary Value | Description   | Format | Binary Bytes | Binary Offset |
|-------|------------|-------------|--------------|---|--------|--------------|---------------|
| 2     | ipservice  | NO_PORT     | 0            | No port   | Enum   | 4            | H             |
|       |            | FTP_SERVER  | 1            | FTP server port. (Default = DISABLE)  |        |              |               |
|       |            | WEB_SERVER  | 2            | Web server port (Default = DISABLE)   |        |              |               |
|       |            | SECURE_ICOM | 3            | <p>Enables or disables security on ICOM ports.</p> <p>When security is enabled, a login is required as part of the connection process (see the <b>LOGIN</b> command on page 222).</p> <p>Default = DISABLE</p> <p><b>Note:</b> Security in this sense means users must supply a name and password before being allowed to enter commands on the ICOM ports. It does not mean there is data encryption</p> |        |              |               |
| 3     | switch     | DISABLE     | 0            | Disable the IP service specified.   | Enum   | 4            | H+4           |
|       |            | ENABLE      | 1            | Enable the IP service specified.  |        |              |               |

## 2.65 ITBANDPASSCONFIG

### *Enable and configure bandpass filter on receiver*

**Platform: OEM719, OEM729, OEM7500, OEM7700, OEM7720, PwrPak7, HxGN PIM7500**

Use this command to apply a bandpass filter at a certain frequency to mitigate interference in the pass band of GNSS signals. The **ITBANDPASSBANK** log (see page 542) provides information on the allowable configuration settings for each frequency band. The bandpass filter is symmetrical in nature, which means that specifying one cutoff frequency will apply a cutoff on both the low side and high side of the spectrum center frequency. Only one filter can be applied for each signal.



On OEM7720 receivers, any filter enabled for GPS L2 or GLONASS L2 on the secondary antenna will be applied to both GPS L2 and GLONASS L2. For this reason, care must be taken to avoid attenuating the signals with a bandpass filter that is too narrow in bandwidth. The recommended maximum lower cutoff frequency is 1221 MHz. The recommended minimum upper cutoff frequency is 1254 MHz.

**Message ID: 1999**

#### **Abbreviated ASCII Syntax:**

```
ITBANDPASSCONFIG frequency switch [cutofffrequency]
```

#### **ASCII Example:**

```
ITBANDPASSCONFIG gpsl5 enable 1165.975
```

| Field | Field Type               | ASCII Value                                      | Binary Value | Description  | Format | Binary Bytes | Binary Offset |
|-------|--------------------------|--|--------------|--|--------|--------------|---------------|
| 1     | ITBANDPASS CONFIG header | -  | -            | Command header. See <i>Messages</i> on page 25 for more information. | -      | H            | 0             |
| 2     | frequency                | See <i>Table 48: Frequency Types</i> on page 210 |              | Set the frequency band on which to apply the filter                  | Enum   | 4            | H             |
| 3     | switch                   | DISABLE  | 0            | Disable filter   | Enum   | 4            | H+4           |
|       |                          | ENABLE   | 1            | Enable filter  |        |              |               |



| Field | Field Type      | ASCII Value | Binary Value | Description   | Format | Binary Bytes | Binary Offset |
|-------|-----------------|-------------|--------------|---|--------|--------------|---------------|
| 4     | cutofffrequency |             |              | Cut off frequency for band pass filter (MHz).<br>(default = 0)<br><br>Refer to <b>ITBANDPASSBANK</b> log (see page 542) for the allowable values. | Float  | 4            | H+8           |

## 2.66 ITDETECTCONFIG

### *Enable interference detection on receiver*

**Platform:** OEM719, OEM729, OEM7500, OEM7700, OEM7720, PwrPak7, HxGN PIM7500

This command is used to enable or disable interference detection on the receiver. It is applicable to both Spectral Analysis Detection and Statistical Analysis Detection at the same time. Detection can be enabled on all RF paths, only one RF path (L1, L2, or L5), or no RF paths. By default, only the RF paths connecting to the first antenna are enabled.

**Message ID:** 2143

#### Abbreviated ASCII Syntax:

```
ITDETECTCONFIG rf_path [reserved1] [reserved2] [reserved3]
```

#### Factory Default:

```
ITDETECTCONFIG all
```

#### ASCII Example:

```
ITDETECTCONFIG L1
```

```
ITDETECTCONFIG none
```

| Field | Field Type            | ASCII Value                                  | Binary Value | Description  | Format | Binary Bytes | Binary Offset |
|-------|-----------------------|--|--------------|--|--------|--------------|---------------|
| 1     | ITDETECTCONFIG header | -  | -            | Command header. See <i>Messages</i> on page 25 for more information.   | -      | H            | 0             |
| 2     | rf_path               | See Table 42: <i>RF Path Selection</i> below |              | RF path selected for detection. By default, all paths are turned on. The receiver will cycle through all active paths. | Enum   | 4            | H             |
| 3     | reserved1             | 0  |              | Reserved parameter   | Ulong  | 4            | H+4           |
| 4     | reserved2             | 0  |              | Reserved parameter   | Ulong  | 4            | H+8           |
| 5     | reserved3             | 0  |              | Reserved parameter   | Ulong  | 4            | H+12          |

**Table 42: RF Path Selection**

| ASCI Value | Binary Value | Description                     |
|------------|--------------|---------------------------------|
| NONE       | 0            | Turn off detection on all paths |

| <b>ASCII Value</b> | <b>Binary Value</b> | <b>Description</b>  |
|--------------------|---------------------|---|
| ALL                | 1                   | Turn on detection on all paths (cycle through all active paths) |
| L1                 | 2                   | Turn on detection only on L1 path                               |
| L2                 | 3                   | Turn on detection only on L2 path                               |
| L5                 | 4                   | Turn on detection only on L5 path                               |

## 2.67 ITFRONTENDMODE

### *Configure the front end mode settings*

**Platform: OEM719, OEM729, OEM7500, OEM7700, OEM7720, PwrPak7, HxGN PIM7500**

Use this command to configure the front end mode for the L1, L2 and L5 RF paths to use the default third-order CIC mode or HDR (High Dynamic Range) mode. The HDR mode is used in an interference environment to obtain best interference rejection in general. However, the power consumption will increase in this mode.

**Message ID: 2039**

#### Abbreviated ASCII Syntax:

```
ITFRONTENDMODE frequency mode
```

#### Factory Default

```
ITFRONTENDMODE L1 cic3
ITFRONTENDMODE L2 cic3
ITFRONTENDMODE LBAND cic3
ITFRONTENDMODE L5 cic3
```

#### ASCII Example:

```
ITFRONTENDMODE L1 hdr
```



On the OEM7500, the default mode for all frequency bands is HDR.

| Field | Field Type            | ASCII Value   | Binary Value | Description  | Format | Binary Bytes | Binary Offset |
|-------|-----------------------|---|--------------|--|--------|--------------|---------------|
| 1     | ITFRONTENDMODE header | -   | -            | Command header. See <i>Messages</i> on page 25 for more information. | -      | H            | 0             |
| 2     | frequency             | See <i>Table 43: Frequency Bands</i> on the next page |              | Set the frequency band for adjustment                                | Enum   | 4            | H             |
| 3     | mode                  | See <i>Table 44: Mode</i> on the next page            |              | Select the desired mode  | Enum   | 4            | H+4           |

**Table 43: Frequency Bands**

| Binary Value | ASCII Value | Description                  |
|--------------|-------------|------------------------------|
| 2            | L1          | Selects the L1 frequency     |
| 3            | L2          | Selects the L2 frequency     |
| 4            | LBAND       | Selects the L-Band frequency |
| 5            | L5          | Selects the L5 frequency     |

**Table 44: Mode**

| Binary Value | ASCII Value | Description                         |
|--------------|-------------|-------------------------------------|
| 0            | CIC3        | 3rd order CIC (CIC3) mode (default) |
| 1            | HDR         | High Dynamic Range (HDR) mode       |

## 2.68 ITPROGFILTCONFIG

### *Enable and configure filtering on the receiver*

**Platform: OEM719, OEM729, OEM7500, OEM7700, OEM7720, PwrPak7, HxGN PIM7500**

Use this command to set the programmable filter to be either a notch filter or a bandpass filter to mitigate interference in the pass band of GNSS signals. The notch filter is used to attenuate a very narrow band of frequencies (specified by the notch width) around the center frequency.

The bandpass filter is symmetrical in nature, which means that specifying one cutoff frequency will apply a cutoff on both the low side and high side of the spectrum center frequency.

The **ITPROGFILTBANK** log (see page 550) provides information on the allowable configuration settings for the programmable filter (i.e. the allowable settings for the notch filter and bandpass filter) for each frequency band. Only one filter can be applied for each signal.

**Message ID: 2000**

#### Abbreviated ASCII Syntax:

```
ITPROGFILTCONFIG frequency progid switch [filtermode] [cutofffreq]
[notchwidth]
```

#### ASCII Example:

```
ITPROGFILTCONFIG gps11 pf0 enable notchfilter 1580 1
```

| Field | Field Type               | ASCII Value  | Binary Value | Description  | Format | Binary Bytes | Binary Offset |
|-------|--------------------------|--|--------------|--|--------|--------------|---------------|
| 1     | ITPROGFILT CONFIG header | -  | -            | Command header. See <i>Messages</i> on page 25 for more information. | -      | H            | 0             |
| 2     | frequency                | See <i>Table 48: Frequency Types</i> on page 210               |              | Set the frequency band on which to apply the filter                  | Enum   | 4            | H             |
| 3     | progid                   | See <i>Table 45: Programmable Filter ID</i> on the next page   |              | Select the filter ID to use  | Enum   | 4            | H+4           |
| 4     | switch                   | DISABLE  | 0            | Disable the filter   | Enum   | 4            | H+8           |
|       |                          | ENABLE   | 1            | Enable the filter  |        |              |               |
| 5     | filtermode               | See <i>Table 46: Programmable Filter Mode</i> on the next page |              | Configure the type of filter to use (default = NONE)                 | Enum   | 4            | H+12          |

| Field | Field Type | ASCII Value | Binary Value | Description   | Format | Binary Bytes | Binary Offset |
|-------|------------|-------------|--------------|---|--------|--------------|---------------|
| 6     | cutofffreq |             |              | Center frequency for notch filter or cut off frequency for bandpass filter (MHz).<br><br>Refer to <b>ITPROGFILTBANK</b> log (see page 550) for the allowable values.<br>(default = 0) | Float  | 4            | H+16          |
| 7     | notchwidth |             |              | Notch width (MHz).<br><br>Refer to <b>ITPROGFILTBANK</b> log (see page 550) for the allowable values.<br>(default = 0)  | Float  | 4            | H+20          |

**Table 45: Programmable Filter ID**

| Binary Value | ASCII Value | Description           |
|--------------|-------------|-----------------------|
| 0            | PF0         | Programmable Filter 0 |
| 1            | PF1         | Programmable Filter 1 |

**Table 46: Programmable Filter Mode**

| Binary Value | ASCII Value | Description  |
|--------------|-------------|--|
| 0            | NOTCHFILT   | Configure the filter as a notch filter   |
| 1            | BANDPASSFIL | Configure the filter as a bandpass filter  |
| 2            | NONE        | Turn off filter<br><br>If the switch parameter is set to ENABLED while the filtermode parameter is set to NONE, the system will return a parameter out of range message. |

## 2.69 ITSPECTRALANALYSIS

### *Enable and configure spectral analysis on receiver*

**Platform:** OEM719, OEM729, OEM7500, OEM7700, OEM7720, PwrPak7, HxGN PIM7500

Use this command to view the spectrum in a range of frequencies. The **ITSPECTRALANALYSIS** command enables and configures the spectral analysis. The spectrum is viewed by plotting the PSD samples in the **ITPSDFINAL** log (see page 552). The FFT windowing used is Hanning.



Decreasing the update period or increasing the FFT size will impact receiver idle time. The idle time should be monitored to prevent adverse effects on receiver performance.

**Message ID:** 1967

#### **Abbreviated ASCII Syntax:**

```
ITSPECTRALANALYSIS mode [frequency] [updateperiod] [FFTsize] [timeavg]
[subcarrieravg]
```

#### **Factory Default:**

```
ITSPECTRALANALYSIS off
```

#### **ASCII Example:**

```
ITSPECTRALANALYSIS predecimation gps11 100 16k 0 0
```

| Field | Field Type                 | ASCII Value  | Binary Value | Description  | Format | Binary Bytes | Binary Offset |
|-------|----------------------------|--|--------------|--|--------|--------------|---------------|
| 1     | ITSPECTRAL ANALYSIS header | -  | -            | Command header. See <i>Messages</i> on page 25 for more information. | -      | H            | 0             |
| 2     | mode                       | See Table 47: <i>Data Sources for PSD Samples</i> on the next page |              | Set the view mode  | Enum   | 4            | H             |
| 3     | frequency                  | See Table 48: <i>Frequency Types</i> on page 210                   |              | Set the frequency band to view                                       | Enum   | 4            | H+4           |



| Field | Field Type    | ASCII Value                         | Binary Value | Description   | Format | Binary Bytes | Binary Offset |
|-------|---------------|-------------------------------------|--------------|---|--------|--------------|---------------|
| 4     | updateperiod  | 50 to 100000                        |              | The spectrum update rate in milliseconds<br>The update period is limited by the FFT size chosen. For 32k the minimum update period is 100 ms and for 64k the minimum update period is 200 ms.<br>(default = 1000) | Ulong  | 4            | H+8           |
| 5     | FFTsize       | See Table 49: FFT Sizes on page 211 |              | The frequency resolution of the spectrum<br>(default = 1k)  | Enum   | 4            | H+12          |
| 6     | timeavg       | 0 to 50                             |              | Time averaging window in seconds (default = 10)   | Ulong  | 4            | H+16          |
| 7     | subcarrieravg | 0 to 30                             |              | The sliding window average over a number of FFT samples<br>(default = 5)  | Ulong  | 4            | H+20          |

**Table 47: Data Sources for PSD Samples**

| Binary Value | ASCII Value    | Description   |
|--------------|----------------|---|
| 0            | OFF            | Disable spectral analysis   |
| 1            | PREDECIMATION  | Perform spectrum analysis on the pre-decimated spectrum.<br>This can be used to see a wide view of the spectrum for an RF path (L1, L2 or L5).  |
| 2            | POSTDECIMATION | Perform spectrum analysis on the post-decimated spectrum.<br>This is narrower than predecimation and is used to see the spectrum for a given signal.                                    |
| 3            | POSTFILTER     | Perform spectrum analysis on the post-filtered spectrum.<br>This can be used when either bandpass or notch filters have been enabled to see the spectrum after the filters are applied. |

**Table 48: Frequency Types**

| Binary Value   | ASCII Value   | Description               |
|----------------|---------------|---------------------------|
| 0              | GPSL1         | GPS L1 frequency          |
| 1              | GPSL2         | GPS L2 frequency          |
| 2              | GLONASSL1     | GLONASS L1 frequency      |
| 3              | GLONASSL2     | GLONASS L2 frequency      |
| 4              | Reserved      |                           |
| 5              | GPSL5         | GPS L5 frequency          |
| 6 <sup>1</sup> | LBAND         | Inmarsat L-Band frequency |
| 7              | GALILEOE1     | Galileo E1 frequency      |
| 8              | GALILEOE5A    | Galileo E5A frequency     |
| 9              | GALILEOE5B    | Galileo E5B frequency     |
| 10             | GALILEOALTBOC | Galileo AltBOC frequency  |
| 11             | BEIDOUB1      | BeiDou B1 frequency       |
| 12             | BEIDOUB2      | BeiDou B2 frequency       |
| 13             | QZSSL1        | QZSS L1 frequency         |
| 14             | QZSSL2        | QZSS L2 frequency         |
| 15             | QZSSL5        | QZSS L5 frequency         |
| 16             | QZSSL6        | QZSS L6 frequency         |
| 17             | GALILEOE6     | Galileo E6 frequency      |
| 18             | BEIDOUB3      | BeiDou B3 frequency       |
| 19             | GLONASSL3     | GLONASS L3 frequency      |
| 20             | NAVICL5       | NavIC L5 frequency        |



The post-decimation spectrum is not available for the Galileo AltBOC frequency. Only the pre-decimation spectrum is available for Galileo AltBOC.

<sup>1</sup>Must first enable L-Band using the ASSIGNLBANDBEAM command.

**Table 49: FFT Sizes**

| Binary Value | ASCII Value | Description            |
|--------------|-------------|------------------------|
| 0            | 1K          | 1K FFT, 1024 samples   |
| 1            | 2K          | 2K FFT, 2048 samples   |
| 2            | 4K          | 4K FFT, 4096 samples   |
| 3            | 8K          | 8K FFT, 8192 samples   |
| 4            | 16K         | 16K FFT, 16384 samples |
| 5            | 32K         | 32K FFT, 32768 samples |
| 6            | 64K         | 64K FFT, 65536 samples |



The 64k FFT is not available in post-decimation or post-filter modes.

## 2.70 J1939CONFIG

### Configure CAN network-level parameters

**Platform: OEM719, OEM729, OEM7500, OEM7700, OEM7720, PwrPak7, HxGN PIM7500**

Use this command to configure the CAN J1939 network-level parameters (NAME, etc).

Issuing this command may initiate a CAN 'Address Claim' procedure. The status of the node and address claim are reported in the **J1939STATUS** log (see page 555).

Once a "node" is configured using **J1939CONFIG**, and the "port" is configured to ON using CANCONFIG "port" ON, J1939CONFIG "node" cannot be entered again until the "port" is configured to "OFF" using CANCONFIG "port" OFF. (See the **CANCONFIG** command on page 96

**Message ID: 1903**

#### Abbreviated ASCII Syntax:

```
J1939CONFIG node port [pref_addr [alt_addr_range_start] [alt_addr_range_end]
[mfgcode] [industry] [devclass] [devinstance] [func] [funcinstance]
[ECUinstance]]
```

#### Factory Default:

```
J1939CONFIG NODE1 CAN1 1C 0 FD 305 2 0 0 23 0 0
J1939CONFIG NODE2 CAN2 1C 0 FD 305 2 0 0 23 0 0
```

#### ASCII Example :

```
J1939CONFIG NODE1 CAN1 AA 0 FD 305 2 0 0 23 0 0
```

| Field | Field Type         | ASCII Value | Binary Value | Description  | Format | Binary Bytes | Binary Offset |
|-------|--------------------|-------------|--------------|--|--------|--------------|---------------|
| 1     | J1939CONFIG header | -           | -            | Command header. See <i>Messages</i> on page 25 for more information.               | -      | H            | 0             |
| 2     | node               | NODE1       | 1            | Identifies the J1939 Node (i.e. CAN NAME)  | Enum   | 4            | H             |
|       |                    | NODE2       | 2            |  |        |              |               |
| 3     | port               | CAN1        | 1            | Physical CAN port to use   | Enum   | 4            | H+4           |
|       |                    | CAN2        | 2            |  |        |              |               |
| 4     | pref_addr          | 0x0 - 0xFD  |              | Preferred CAN address. The receiver attempts to claim this address (default = 0x0) | Ulong  | 4            | H+8           |

| Field | Field Type           | ASCII Value | Binary Value | Description  | Format | Binary Bytes | Binary Offset |
|-------|----------------------|-------------|--------------|--|--------|--------------|---------------|
| 5     | alt_addr_range_start | 0x0 - 0xFD  |              | When the pref_addr cannot be claimed, the receiver attempts to claim an address from this range.<br>(default: 0x0) | Ulong  | 4            | H+12          |
| 6     | alt_addr_range_end   | 0x0 - 0xFD  |              | End of alternative address range.<br>(default: 0xFD)   | Ulong  | 4            | H+16          |
| 7     | mfgcode              | 0-2047      |              | NAME: Manufacturer Code. Refer to ISO 11783-5.<br>(default: 0)   | Ulong  | 4            | H+20          |
| 8     | industry             | 0 - 7       |              | NAME: Industry Group<br>(default: 2)   | Ulong  | 4            | H+24          |
| 9     | devclass             | 0 - 127     |              | NAME: Device Class<br>(default: 0)   | Ulong  | 4            | H+28          |
| 10    | devinstance          | 0 - 15      |              | NAME: Device Class Instance<br>(default: 0)  | Ulong  | 4            | H+32          |
| 11    | func                 | 0 - 255     |              | NAME: Function<br>(default: 23)  | Ulong  | 4            | H+36          |
| 12    | funcinstance         | 0 - 31      |              | NAME: Function instance<br>(default: 0)  | Ulong  | 4            | H+40          |
| 13    | ECUinstance          | 0 - 7       |              | NAME: ECU Instance<br>(default: 0)   | Ulong  | 4            | H+44          |



Due to current limitations in the CAN stack, NODE1 can only be associated with CAN1 and NODE2 can only be associated with CAN2. A mismatch combination results in an 'invalid parameter' error.



Node statistics are reported in the **J1939STATUS** log (see page 555).

## 2.71 LOCKOUT

*Prevents the receiver from using a satellite*

**Platform: OEM719, OEM729, OEM7500, OEM7700, OEM7720, PwrPak7, HxGN PIM7500**

This command is used to prevent the receiver from using a satellite in the solution computations.



The **LOCKOUT** command does not prevent the receiver from tracking an undesirable satellite.

**LOCKOUT** command and **UNLOCKOUT** command (see page 373) can be used with GPS, GLONASS, SBAS and QZSS PRNs.

This command must be repeated for each satellite to be locked out. See also the **UNLOCKOUT** command on page 373 and **UNLOCKOUTALL** command on page 374.

**Message ID: 137**

**Abbreviated ASCII Syntax:**

```
LOCKOUT prn
```

**Input Example:**

```
LOCKOUT 8
```



The **LOCKOUT** command removes one or more satellites from the solution while leaving other satellites available.

| Field | Field Type     | ASCII Value                            | Binary Value | Description  | Format | Binary Bytes | Binary Offset |
|-------|----------------|--|--------------|--|--------|--------------|---------------|
| 1     | LOCKOUT header | -                                      | -            | Command header. See <i>Messages</i> on page 25 for more information. | -      | H            | 0             |
| 2     | prn            | Refer to <i>PRN Numbers</i> on page 46 |              | Unique identifier for the satellite being locked out                 | Ulong  | 4            | H             |

## 2.72 LOCKOUTSYSTEM

*Prevents the receiver from using a system*

**Platform:** OEM719, OEM729, OEM7500, OEM7700, OEM7720, PwrPak7, HxGN PIM7500

This command is used to prevent the receiver from using satellites in a system in the solution computations.



The **LOCKOUTSYSTEM** command does not prevent the receiver from tracking an undesirable satellite.

This command must be repeated for each system to be locked out. See also the **UNLOCKOUTSYSTEM** command on page 375 and **UNLOCKOUTALL** command on page 374.

**Message ID:** 871

**Abbreviated ASCII Syntax:**

```
LOCKOUTSYSTEM system
```

**Factory Defaults:**

```
LOCKOUTSYSTEM galileo
```

```
LOCKOUTSYSTEM sbas
```

```
LOCKOUTSYSTEM navic
```



The **LOCKOUTSYSTEM** command removes one or more systems from the solution while leaving other systems available.

| Field | Field Type           | ASCII Value  | Binary Value | Description  | Format | Binary Bytes | Binary Offset |
|-------|----------------------|--|--------------|--|--------|--------------|---------------|
| 1     | LOCKOUTSYSTEM header | -  | -            | Command header. See <i>Messages</i> on page 25 for more information. | -      | H            | 0             |
| 2     | system               | See <i>Table 102: Satellite System</i> on page 532 |              | A single satellite system to be locked out                           | Enum   | 4            | H             |

## 2.73 LOG

### *Requests logs from the receiver*

**Platform: OEM719, OEM729, OEM7500, OEM7700, OEM7720, PwrPak7, HxGN PIM7500**

Many different types of data can be logged using different methods of triggering the log events. Every log element can be directed to any combination of the receiver's ports. The ontime trigger option requires the addition of the period parameter. See *Logs* on page 391 for further information and a complete list of data log structures. The LOG command tables in this section show the binary format followed by the ASCII command format.

The optional parameter [hold] prevents a log from being removed when the **UNLOGALL** command (see page 378), with its defaults, is issued. To remove a log which was invoked using the [hold] parameter requires the specific use of the **UNLOG** command (see page 376). To remove all logs that have the [hold] parameter, use the **UNLOGALL** command (see page 378) with the held field set to 1.

The [port] parameter is optional. If [port] is not specified, [port] is defaulted to the port that the command was received on.



1. The OEM7 family of receivers can handle 80 simultaneous log requests. If an attempt is made to log more than 80 logs at a time, the receiver responds with an Insufficient Resources error. Note that **RXSTATUSEVENTA** logs are requested on most ports by default and these logs count against the 80.
2. The user is cautioned that each log requested requires additional CPU time and memory buffer space. Too many logs may result in lost data and low CPU idle time. Receiver overload can be monitored using the idle-time field and buffer overload bits of the Receiver Status in any log header.
3. Only the **MARKPOS, MARK2POS, MARK3POS and MARK4POS** log (see page 569), **MARKTIME, MARK2TIME, MARK3TIME and MARK4TIME** log (see page 572) and 'polled' log types are generated, on the fly, at the exact time of the mark. Synchronous and asynchronous logs output the most recently available data.
4. Use the ONNEW trigger with the **MARKPOS, MARK2POS, MARK3POS and MARK4POS** log (see page 569) and **MARKTIME, MARK2TIME, MARK3TIME and MARK4TIME** log (see page 572).
5. Polled log types allow fractional offsets and ONTIME rates up to the maximum logging rate as defined by the receiver model.
6. If ONTIME trigger is used with asynchronous logs, the time stamp in the log does not necessarily represent the time the data was generated but rather the time when the log is transmitted.
7. Published logs are not placed in a queue if there is no physical or virtual connection when the log is generated. Thus, a log requested ONNEW or ONCHANGED that is in SAVECONFIG may not be received if it is published before connections are made. This can happen if there's no cable connected or if the communication protocol has not been established yet (e.g. CAN, Ethernet, USB, etc).

**Message ID: 1**



**Abbreviated ASCII Syntax:**

```
LOG [port] message ONNEW
LOG [port] message ONCHANGED
LOG [port] message ONTIME period [offset [hold]]
LOG [port] message ONNEXT
LOG [port] message ONCE
LOG [port] message ONMARK
```

**Factory Default:**

```
LOG COM1 RXSTATUSEVENTA ONNEW
LOG COM2 RXSTATUSEVENTA ONNEW
LOG COM3 RXSTATUSEVENTA ONNEW
LOG AUX RXSTATUSEVENTA ONNEW
LOG USB1 RXSTATUSEVENTA ONNEW
LOG USB2 RXSTATUSEVENTA ONNEW
LOG USB3 RXSTATUSEVENTA ONNEW
LOG ICOM1 RXSTATUSEVENTA ONNEW
LOG ICOM2 RXSTATUSEVENTA ONNEW
LOG ICOM3 RXSTATUSEVENTA ONNEW
LOG ICOM4 RXSTATUSEVENTA ONNEW
LOG ICOM5 RXSTATUSEVENTA ONNEW
LOG ICOM6 RXSTATUSEVENTA ONNEW
LOG ICOM7 RXSTATUSEVENTA ONNEW
```

**Abbreviated ASCII Example 1:**

```
LOG COM1 BESTPOS ONTIME 7 0.5 HOLD
```

The above example shows **BESTPOS** logging to com port 1 at 7 second intervals and offset by 0.5 seconds (output at 0.5, 7.5, 14.5 seconds and so on). The [hold] parameter is set so that logging is not disrupted by the **UNLOGALL** command (see page 378).

To send a log once, the trigger option can be omitted.

**Abbreviated ASCII Example 2:**

```
LOG COM1 BESTPOS ONCE
```



Using the NovAtel Connect utility there are two ways to initiate data logging from the receiver's serial ports. Either enter the **LOG** command in the *Console* window or use the interface provided in the *Logging Control* window. Ensure the Power Settings on the computer are not set to go into Hibernate or Standby modes. Data is lost if one of these modes occurs during a logging session.

**2.73.1 Binary**

| Field | Field Type          | Binary Value   | Description                            | Format | Binary Bytes | Binary Offset |
|-------|---------------------|--|--|--------|--------------|---------------|
| 1     | LOG (binary) header | See <i>Table 3: Binary Message Header Structure</i> on page 30   | This field contains the message header | -      | H            | 0             |
| 2     | port                | See <i>Table 4: Detailed Port Identifier</i> on page 31  | Output port                            | Enum   | 4            | H             |
| 3     | message             | Any valid message ID   | Message ID of the log to output        | Ushort | 2            | H+4           |
| 4     | message type        | Bits 0-4 = Measurement source <sup>1</sup><br>Bits 5-6 = Format<br>00 = Binary<br>01 = ASCII<br>10 = Abbreviated ASCII, NMEA<br>11 = Reserved<br>Bit 7 = Response Bit ( <i>Binary Response</i> on page 43)<br>0 = Original Message<br>1 = Response Message | Message type of log                    | Char   | 1            | H+6           |
| 5     | Reserved            |  |  | Char   | 1            | H+7           |

<sup>1</sup>Bits 0-4 are used to indicate the measurement source. For dual antenna receivers, if bit 0 is set, the log is from the secondary antenna.

| Field | Field Type | Binary Value  | Description   | Format | Binary Bytes | Binary Offset |
|-------|------------|---------------|---|--------|--------------|---------------|
| 6     | trigger    | 0 = ONNEW     | Does not output current message but outputs when the message is updated (not necessarily changed)                         | Enum   | 4            | H+8           |
|       |            | 1 = ONCHANGED | Outputs the current message and then continues to output when the message is changed                                      |        |              |               |
|       |            | 2 = ONTIME    | Output on a time interval   |        |              |               |
|       |            | 3 = ONNEXT    | Output only the next message  |        |              |               |
|       |            | 4 = ONCE      | Output only the current message (default). If no message is currently present, the next message is output when available. |        |              |               |
|       |            | 5 = ONMARK    | Output when a pulse is detected on the mark 1 input, MK1I <sup>1 2</sup>  |        |              |               |

<sup>1</sup>Refer to the Technical Specifications appendix in the [OEM7 Installation and Operation User Manual](#) for more details on the MK1I pin. ONMARK only applies to MK1I. Events on MK2I (if available) do not trigger logs when ONMARK is used. Use the ONNEW trigger with the MARKTIME, MARK2TIME, MARKPOS or MARK2POS logs.

<sup>2</sup>Once the 1PPS signal has hit a rising edge, for both MARKPOS and MARKTIME logs, a resolution of both measurements is 10 ns. As for the ONMARK trigger for other logs that measure latency, for example RANGE and POSITION logs such as BESTPOS, it takes typically 20-30 ms (50 ms maximum) for the logs to output information from the 1PPS signal. Latency is the time between the reception of the 1PPS pulse and the first byte of the associated log. See also the **MARKPOS, MARK2POS, MARK3POS and MARK4POS** log on page 569 and the **MARKTIME, MARK2TIME, MARK3TIME and MARK4TIME** log on page 572.

| Field | Field Type | Binary Value   | Description  | Format | Binary Bytes | Binary Offset |
|-------|------------|--|--|--------|--------------|---------------|
| 7     | period     | Valid values for the high rate logging are 0.05, 0.1, 0.2, 0.25 and 0.5. For logging slower than 1 Hz any integer value is accepted  | Log period (for ONTIME trigger) in seconds<br><br>If the value entered is lower than the minimum measurement period, the command will be rejected. See Appendix A in the <a href="#">OEM7 Installation and Operation User Manual</a> for the maximum raw measurement rate to calculate the minimum period.                         | Double | 8            | H+12          |
| 8     | offset     | Offset for period (ONTIME trigger) in seconds. To log data at 1 second, after every minute, set the period to 60 and the offset to 1 | A valid value is any integer (whole number) smaller than the period.<br><br>These decimal values, on their own, are also valid: 0.1, 0.2, 0.25 or 0.5, as well as any multiple of the maximum logging rate defined by the receiver model. The offset cannot be smaller than the minimum measurement period supported by the model. | Double | 8            | H+20          |
| 9     | hold       | 0 = NOHOLD   | Allow log to be removed by the <b>UNLOGALL</b> command (see page 378)  | Enum   | 4            | H+28          |
|       |            | 1 = HOLD   | Prevent log from being removed by the default <b>UNLOGALL</b> command (see page 378)   |        |              |               |

**2.73.2 ASCII**

| Field | Field Name         | ASCII Value   | Description  | Format   |
|-------|--------------------|---|--|----------|
| 1     | LOG (ASCII) header | -   | This field contains the command name or the message header depending on whether the command is abbreviated ASCII or ASCII respectively   | -        |
| 2     | port               | <i>Table 4: Detailed Port Identifier on page 31</i>                                 | Output port (default = THISPORT)   | Enum     |
| 3     | message            | Any valid message name, with an optional A or B suffix                              | Message name of log to output  | Char [ ] |
| 4     | trigger            | ONNEW   | Output when the message is updated (not necessarily changed)   | Enum     |
|       |                    | ONCHANGED   | Output when the message is changed   |          |
|       |                    | ONTIME  | Output on a time interval  |          |
|       |                    | ONNEXT  | Output only the next message   |          |
|       |                    | ONCE  | Output only the current message (default)  |          |
|       |                    | ONMARK  | Output when a pulse is detected on the mark 1 input, MK1I <sup>1 2</sup>   |          |
| 5     | period             | Any positive double value larger than the receiver's minimum raw measurement period | Log period (for ONTIME trigger) in seconds (default = 0)<br><br>If the value entered is lower than the minimum measurement period, the command will be rejected. See Appendix A in the <a href="#">OEM7 Installation and Operation User Manual</a> for the maximum raw measurement rate to calculate the minimum period. | Double   |
| 6     | offset             | Any positive double value smaller than the period                                   | Offset for period (ONTIME trigger) in seconds. If you want to log data, at 1 second after every minute, set the period to 60 and the offset to 1 (default = 0)   | Double   |
| 7     | hold               | NOHOLD  | To be removed by the <b>UNLOGALL</b> command (see page 378) (default)  | Enum     |
|       |                    | HOLD  | Prevent log from being removed by the default <b>UNLOGALL</b> command (see page 378)   |          |

## 2.74 LOGIN

### *Start a secure ICOM/SCOM connection to the receiver*

**Platform: OEM729, OEM7700, OEM7720, PwrPak7**

When ICOM/SCOM ports have security enabled (see the **IPSERVICE** command on page 198), a session to the ICOM/SCOM port can be established but commands are refused until a valid **LOGIN** command is issued. Both the UserName and Password are required. The **LOGIN** command checks the supplied credentials against known UserNames/Passwords and determines if the login is successful or not. A successful login permits the secured ICOM/SCOM command interpreter to accept further commands and returns OK. An unsuccessful login does not release the secured ICOM/SCOM command interpreter and returns Login Failed.

Entering a **LOGIN** command on any command port other than the ICOM/SCOM port has no effect, regardless of whether the UserName/Password is correct. In this case, the appropriate response (OK or Login Failed) is returned, but there is no effect on the command interpreter.



When security is enabled, access to the port is restricted unless a valid name and password are supplied. It does not mean there is data encryption enabled. Username is case-insensitive and password is case-sensitive.

**Message ID: 1671**

#### **Abbreviated ASCII Syntax:**

```
LOGIN [commport] UserName Password
```

#### **ASCII Example:**

```
LOGIN ADMIN ADMINPASSWORD
```

| Field | Field Type   | ASCII Value | Binary Value | Description  | Format | Binary Bytes | Binary Offset |
|-------|--------------|-------------|--------------|--|--------|--------------|---------------|
| 1     | LOGIN header | -           | -            | Command header. See <i>Messages</i> on page 25 for more information. | -      | H            | 0             |

| Field | Field Type | ASCII Value | Binary Value | Description   | Format         | Binary Bytes  | Binary Offset |
|-------|------------|-------------|--------------|---|----------------|---------------|---------------|
| 2     | commport   | ICOM1       | 23           | The ICOM or SCOM port to log into.<br>This is an optional parameter.<br>If no value is entered, logs in to the ICOM port currently being used. (default=THISPORT) | Enum           | 4             | H             |
|       |            | ICOM2       | 24           |   |                |               |               |
|       |            | ICOM3       | 25           |   |                |               |               |
|       |            | ICOM4       | 29           |   |                |               |               |
|       |            | ICOM5       | 46           |   |                |               |               |
|       |            | ICOM6       | 47           |   |                |               |               |
|       |            | ICOM7       | 48           |   |                |               |               |
|       |            | SCOM1       | 49           |   |                |               |               |
|       |            | SCOM2       | 50           |   |                |               |               |
|       |            | SCOM3       | 51           |   |                |               |               |
| SCOM4 | 52         |             |              |   |                |               |               |
| 3     | username   |             |              | Provide the user name for the login command.<br>The user name is not case sensitive.  | String<br>[32] | variable<br>1 | H+4           |
| 4     | password   |             |              | Provide the password for the user name. The password is case sensitive  | String<br>[28] | variable<br>1 | variable      |

<sup>1</sup>In the binary case, each string field needs to be NULL terminated and additional bytes of padding added to maintain 4-byte alignment, up to the maximum defined by the string size. The next defined field starts immediately at the next 4-byte alignment following the NULL.

## 2.75 LOGOUT

**End a secure ICOM/SCOM session started using the LOGIN command**

**Platform: OEM729, OEM7700, OEM7720, PwrPak7**

Use the **LOGOUT** command to sign out of an ICOM/SCOM connection after a user has successfully logged in using the **LOGIN** command. After the sending the **LOGOUT** command, the ICOM/SCOM connection will not accept further commands, other than a new LOGIN command. The session itself is not ended. This only applies to ICOM/SCOM ports that have had security enabled (see the **IPSERVICE** command on page 198).

**Message ID: 1672**

**Abbreviated ASCII Syntax:**

```
LOGOUT [commport]
```

**ASCII Example:**

```
LOGOUT
```

| Field | Field Type    | ASCII Value | Binary Value | Description  | Format | Binary Bytes | Binary Offset |
|-------|---------------|-------------|--------------|--|--------|--------------|---------------|
| 1     | LOGOUT header | -           | -            | Command header. See <i>Messages</i> on page 25 for more information.   | -      | H            | 0             |
| 2     | commport      | ICOM1       | 23           | The ICOM or SCOM port from which to log out. This is an optional parameter. If no value is entered, logs out from the ICOM/SCOM port currently being used. | Enum   | 4            | H             |
|       |               | ICOM2       | 24           |  |        |              |               |
|       |               | ICOM3       | 25           |  |        |              |               |
|       |               | ICOM4       | 29           |  |        |              |               |
|       |               | ICOM5       | 46           |  |        |              |               |
|       |               | ICOM6       | 47           |  |        |              |               |
|       |               | ICOM7       | 48           |  |        |              |               |
|       |               | SCOM1       | 49           |  |        |              |               |
|       |               | SCOM2       | 50           |  |        |              |               |
|       |               | SCOM3       | 51           |  |        |              |               |
|       |               | SCOM4       | 52           |  |        |              |               |



## 2.76 MAGVAR

### *Sets a magnetic variation correction*

**Platform: OEM719, OEM729, OEM7500, OEM7700, OEM7720, PwrPak7, HxGN PIM7500**

The receiver computes directions referenced to True North (also known as geodetic north). The Magnetic Variation Correction command (MAGVAR) is used to navigate in agreement with magnetic compass bearings. The correction value entered here causes the "bearing" field of the navigate log to report bearing in degrees Magnetic. The receiver computes the magnetic variation correction when using the auto option. See *Figure 5: Illustration of Magnetic Variation and Correction* on the next page.

The receiver calculates values of magnetic variation for given values of latitude, longitude and time using the International Geomagnetic Reference Field (IGRF) 2015 spherical harmonic coefficients and IGRF time corrections to the harmonic coefficients. (IGRF-2015 is also referred to as IGRF-12.) The model is intended for use up to the year 2020. The receiver will compute for years beyond 2020 but accuracy may be reduced.

**Message ID: 180**

#### **Abbreviated ASCII Syntax:**

```
MAGVAR type [correction [std dev]]
```

#### **Factory Default:**

```
MAGVAR correction 0 0
```

#### **ASCII Example 1:**

```
MAGVAR AUTO
```

#### **ASCII Example 2:**

```
MAGVAR CORRECTION 15 0
```

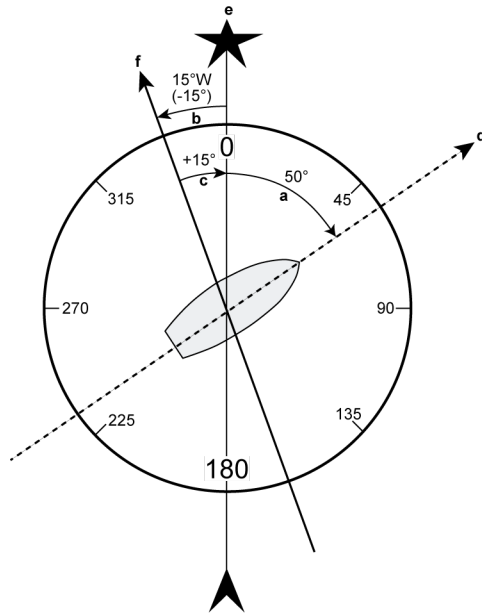
**Figure 5: Illustration of Magnetic Variation and Correction**

| Ref   | Description  |
|-------|--|
| a     | True Bearing   |
| b     | Local Magnetic Variation   |
| c     | Local Magnetic Variation Correction<br>(Inverse of magnetic variation) |
| a + c | Magnetic Bearing   |
| d     | Heading: 50° True, 60° Magnetic  |
| e     | True North   |
| f     | Local Magnetic North   |



How does GNSS determine what Magnetic North is? Do the satellites transmit a database or some kind of look up chart to determine the declination for your given latitude and longitude? How accurate is it?

Magnetic North refers to the location of the Earth's Magnetic North Pole. Its position is constantly changing in various cycles over centuries, years and days. These rates of change vary and are not well understood. However, we are able to monitor the changes.

True North refers to the earth's spin axis, that is, at 90° north latitude or the location where the lines of longitude converge. The position of the spin axis does not vary with respect to the Earth.

The locations of these two poles do not coincide. Thus, a relationship is required between these two values for users to relate GNSS bearings to their compass bearings. This value is called the magnetic variation correction or declination.

GNSS does not determine where Magnetic North is nor do the satellites provide magnetic correction or declination values. However, OEM7 receivers store this information internally in look up tables so that when you specify that you want to navigate with respect to Magnetic North, this internal information is used. These values are also available from various information sources such as the United States Geological Survey (USGS). The USGS produces maps and has software which enables the determination of these correction values. By identifying your location (latitude and longitude), you can obtain the correction value. Refer to [An Introduction to GNSS](#) available on our website.

| Field | Field Type    | ASCII Value     | Binary Value | Description  | Format | Binary Bytes | Binary Offset |
|-------|---------------|-----------------|--------------|--|--------|--------------|---------------|
| 1     | MAGVAR header | -               | -            | Command header. See <i>Messages</i> on page 25 for more information. | -      | H            | 0             |
| 2     | type          | AUTO            | 0            | Use IGRF corrections   | Enum   | 4            | H             |
|       |               | CORRECTION      | 1            | Use the correction supplied  |        |              |               |
| 3     | correction    | ± 180.0 degrees |              | Magnitude of correction (Required field if type = Correction)        | Float  | 4            | H+4           |
| 4     | std_dev       | ± 180.0 degrees |              | Standard deviation of correction (default = 0)                       | Float  | 4            | H+8           |

## 2.77 MARKCONTROL

### *Controls processing of mark inputs*

**Platform: OEM719, OEM729, OEM7500, OEM7700, OEM7720, PwrPak7, HxGN PIM7500**

This command is used to control the processing of the mark inputs. Using this command, the mark inputs can be enabled or disabled, polarity can be changed and a time offset and guard against extraneous pulses can be added.

The MARKPOS and MARKTIME logs have their outputs (and extrapolated time tags) pushed into the future (relative to the mark input (MKI) event) by the amount entered into the time bias field. In almost all cases, this value is set to 0, which is also the default setting (see *MARKPOS*, *MARK2POS*, *MARK3POS* and *MARK4POS* on page 569 and *MARKTIME*, *MARK2TIME*, *MARK3TIME* and *MARK4TIME* on page 572).

**Message ID: 614**

#### Abbreviated ASCII Syntax:

```
MARKCONTROL signal [switch [polarity [timebias [timeguard]]]]
```

#### Factory Default:

```
MARKCONTROL MARK1 ENABLE
```

```
MARKCONTROL MARK2 ENABLE
```

#### ASCII Example:

```
MARKCONTROL MARK1 ENABLE NEGATIVE 50 100
```

**Figure 6: TTL Pulse Polarity**

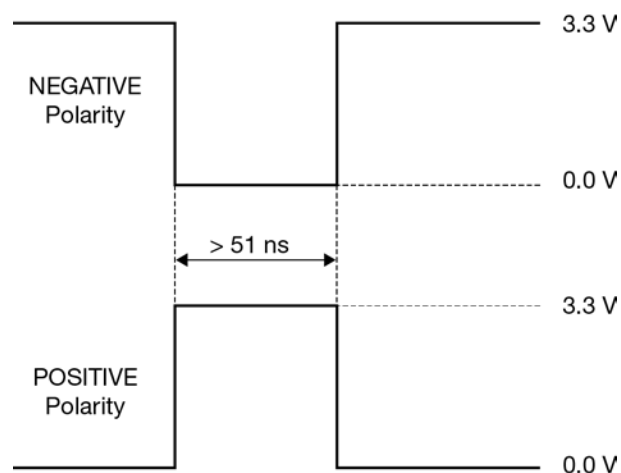



If using an external device, such as a camera, connect the device to the receiver's I/O port. Use a cable that is compatible to both the receiver and the device. A MARKIN pulse can be a trigger from the device to the receiver. See also the **MARKPOS**, **MARK2POS**, **MARK3POS** and **MARK4POS** command on page 569 and the **MARKTIME**, **MARK2TIME**, **MARK3TIME** and **MARK4TIME** command on page 572.

| Field | Field Type         | ASCII Value | Binary Value | Description  | Format | Binary Bytes | Binary Offset |
|-------|--------------------|-------------|--------------|--|--------|--------------|---------------|
| 1     | MARKCONTROL header | -           | -            | Command header. See <i>Messages</i> on page 25 for more information.   | -      | H            | 0             |
| 2     | signal             | MARK1       | 0            | Specifies which mark input the command should be applied to. Set to MARK1 for the Event1 input, MARK2 for Event2, MARK3 for Event3 and MARK4 for Event4. All of the mark inputs have 10 K pull-up resistors to 3.3 V and are leading edge triggered<br><br>MARK3 and MARK4 are available only on OEM7700 and OEM7720 | Enum   | 4            | H             |
|       |                    | MARK2       | 1            |  |        |              |               |
|       |                    | MARK3       | 2            |  |        |              |               |
|       |                    | MARK4       | 3            |  |        |              |               |
| 3     | switch             | DISABLE     | 0            | Disables or enables processing of the mark input signal for the input specified. If DISABLE is selected, the mark input signal is ignored (default = ENABLE)   | Enum   | 4            | H+4           |
|       |                    | ENABLE      | 1            |  |        |              |               |

| Field | Field Type | ASCII Value  | Binary Value | Description   | Format | Binary Bytes | Binary Offset |
|-------|------------|--|--------------|---|--------|--------------|---------------|
| 4     | polarity   | NEGATIVE   | 0            | Optional field to specify the polarity of the pulse to be received on the mark input. See <i>Figure 6: TTL Pulse Polarity</i> on page 228 for more information (default=NEGATIVE) | Enum   | 4            | H+8           |
|       |            | POSITIVE   | 1            |   |        |              |               |
| 5     | timebias   | Any valid long value   |              | Optional value to specify an offset, in nanoseconds, to be applied to the time the mark input pulse occurs (default =0)   | Long   | 4            | H+12          |
| 6     | timeguard  | default: 4<br>minimum: 2<br>Any valid Ulong value larger than the receiver's minimum raw measurement period <sup>1</sup> |              | Optional field to specify a time period, in milliseconds, during which subsequent pulses after an initial pulse are ignored   | Ulong  | 4            | H+16          |

<sup>1</sup>See *Appendix A* in the [OEM7 Installation and Operation User Manual](#) for the maximum raw measurement rate to determine the minimum period. If the value entered is lower than the minimum measurement period, the value is ignored and the minimum period is used.

## 2.78 MEDIAFORMAT

### *Format the media for PwrPak7*

#### **Platform: PwrPak7**

Formats the specified media as FAT32, using PwrPak7 specific cluster size and other parameters.



Only the internal flash memory can be formatted.



Entering this command results in complete loss of all data stored on the media.

Entering this command initiates the format operation. An error is reported if formatting could not be initiated, for example due to the media being disconnected.

Formatting progress can be observed using the **FILESYSTEMSTATUS** log on page 459, which will report *BUSY*, followed by *MOUNTED*.



The receiver may reboot in the process.

#### **Message ID: 2128**

#### **Abbreviated ASCII Syntax:**

```
MEDIAFORMAT <MassStorage>
```

#### **Example:**

```
MEDIAFORMAT INTERNAL_FLASH
```

| Field | Field Type         | ASCII Value    | Binary Value | Description  | Format | Binary Bytes | Binary Offset |
|-------|--------------------|----------------|--------------|--|--------|--------------|---------------|
| 1     | MEDIAFORMAT header | -              | -            | Command header. See <i>Messages</i> on page 25 for more information. | -      | H            | 0             |
| 2     | MassStorageDevice  | INTERNAL_FLASH | 4            | Format the internal memory in the PwrPak7.                           | Enum   | 4            | H             |

## 2.79 MODEL

### *Switches to a previously authorized model*

**Platform:** OEM719, OEM729, OEM7500, OEM7700, OEM7720, PwrPak7, HxGN PIM7500

This command is used to switch the receiver between models previously added with the **AUTH** command (see page 74). When the **MODEL** command is issued, the receiver saves the specified model as the active model. The active model is now used on every subsequent start up. The **MODEL** command causes an automatic reset.

Use the **VALIDMODELS** log (see page 831) to output a list of available models on the receiver. Use the **VERSION** log (see page 836) to output the active model. Use the **AUTHCODES** log (see page 401) to output a list of the auth codes present on the receiver.



If the **MODEL** command is used to switch to an expired model, the receiver will reset and enter into an error state. Switch to a valid model to continue.

**Message ID:** 22

#### Abbreviated ASCII Syntax:

```
MODEL model
```

#### Input Example:

```
MODEL D2LR0RCCR
```



NovAtel uses the term models to refer to and control different levels of functionality in the receiver firmware. For example, a receiver may be purchased with an L1 only capability and be easily upgraded at a later time to a more feature intensive model, like L1/L2 dual-frequency. All that is required to upgrade is an authorization code for the higher model and the **AUTH** command (see page 74). Reloading the firmware or returning the receiver for service to upgrade the model is not required. Upgrades are available from [NovAtel Customer Support](#).

| Field | Field Type   | ASCII Value | Binary Value | Description  | Format | Binary Bytes | Binary Offset |
|-------|--------------|-------------|--------------|--|--------|--------------|---------------|
| 1     | MODEL header | -           | -            | Command header. See <i>Messages</i> on page 25 for more information. | -      | H            | 0             |



---

| Field | Field Type | ASCII Value  | Binary Value | Description | Format                | Binary Bytes  | Binary Offset |
|-------|------------|--|--------------|-------------|-----------------------|---------------|---------------|
| 2     | model      | Max 16 character null-terminated string (including the null) |              | Model name  | String<br>[max<br>16] | Variable<br>1 | H             |

---

<sup>1</sup>In the binary case, each string field needs to be NULL terminated and additional bytes of padding added to maintain 4-byte alignment, up to the maximum defined by the string size. The next defined field starts immediately at the next 4-byte alignment following the NULL.

## 2.80 MOVINGBASESTATION

*Enables the use of a moving base station*

**Platform: OEM719, OEM729, OEM7500, OEM7700, OEM7720, PwrPak7, HxGN PIM7500**

This command is used to enable or disable a receiver from transmitting corrections without a fixed position.

The moving base function allows you to obtain a centimeter level xyz baseline estimate when the base station and possibly the rover are moving. It is very similar to normal RTK, with one stationary base station and a moving rover (refer to *Transmitting and Receiving Corrections* section of the *Operation* chapter in the [OEM7 Installation and Operation User Manual](#)). The BSLNXYZ log is an asynchronous 'matched' log that can be logged with the onchanged trigger to provide an accurate baseline between the base and rover.

Due to the latency of the reference station position messages, the following logs are not recommended to be used when in moving baseline mode: BESTXYZ, GPGST, MARKPOS, MARK2POS, MATCHEDPOS, MATCHEDEYZ, RTKPOS and RTKXYZ. The position error of these logs could exceed 100 m, depending on the latency of the reference station position message. If a rover position is required during moving basestation mode, then PSRPOS is recommended.

The **MOVINGBASESTATION** command must be used to allow the base to transmit messages without a fixed position.



1. Use the PSRPOS position log at the rover. It provides the best accuracy and standard deviations when the MOVINGBASESTATION mode is enabled.
2. This command supports RTCM V3 operation.
3. RTCM V3 support includes GPS + GLONASS operation.

**Message ID: 763**

**Abbreviated ASCII Syntax:**

```
MOVINGBASESTATION switch
```

**Factory Default:**

```
MOVINGBASESTATION disable
```

**ASCII Example:**

```
MOVINGBASESTATION ENABLE
```



Consider the case where there is a fixed base, an airplane flying with a moving base station near its front and a rover station at its tail end. Corrections can be sent between the receivers in a 'daisy chain' effect, where the fixed base station sends corrections to the moving base station, which in turn can send corrections to the rover.

**Figure 7: Moving Base Station 'Daisy Chain' Effect**

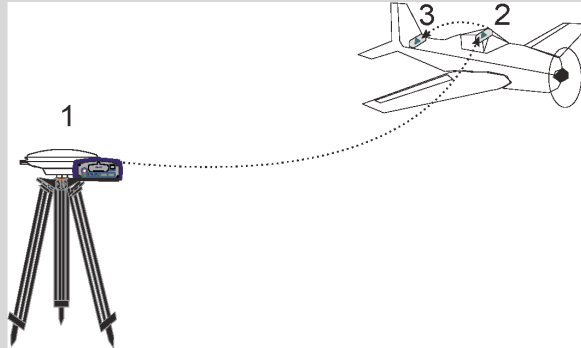

When using this method, the position type is only checked at the fixed base station. Moving base stations will continue to operate under any conditions.

This command is useful for moving base stations doing RTK positioning at sea. A rover station is used to map out local areas (for marking shipping lanes, hydrographic surveying and so on), while the base station resides on the control ship. The control ship may not move much (parked at sea), but there is a certain amount of movement due to the fact that it is floating in the ocean. By using the **MOVINGBASESTATION** command, the control ship is able to use RTK positioning and move to new survey sites.

| Field | Field Type                | ASCII Value | Binary Value | Description  | Format | Binary Bytes | Binary Offset |
|-------|---------------------------|-------------|--------------|--|--------|--------------|---------------|
| 1     | MOVING BASESTATION header | -           | -            | Command header. See <i>Messages</i> on page 25 for more information. | -      | H            | 0             |
| 2     | switch                    | DISABLE     | 0            | Do not transmit corrections without a fixed position                 | Enum   | 4            | H             |
|       |                           | ENABLE      | 1            | Transmit corrections without a fixed position                        |        |              |               |

## 2.81 NAVICECUTOFF

### *Sets elevation cut-off angle for NavIC satellites*

**Platform:** OEM719, OEM729, OEM7500, OEM7700, OEM7720, PwrPak7, HxGN PIM7500

This command is used to set the elevation cut-off angle for tracked NavIC satellites. The receiver does not start automatically searching for a NavIC satellite until it rises above the cut-off angle (when satellite position is known). Tracked satellites that fall below the cut-off angle are no longer tracked unless they are manually assigned (see the **ASSIGN** command on page 66).

In either case, satellites below the NAVICECUTOFF angle are eliminated from the internal position and clock offset solution computations.

This command permits a negative cut-off angle; it could be used in these situations:

- The antenna is at a high altitude, and thus can look below the local horizon
- Satellites are visible below the horizon due to atmospheric refraction



Care must be taken when using **NAVICECUTOFF** command because the signals from lower elevation satellites are traveling through more atmosphere and are therefore degraded. Use of satellites below 5 degrees is not recommended.



Use the **ELEVATIONCUTOFF** command on page 134 to set the cut-off angle for all other systems.



For dual antenna receivers, this command applies to both the primary and secondary antennas.

**Message ID: 2134**

**Abbreviated ASCII Syntax:**

```
NAVICECUTOFF angle
```

**Factory Default:**

```
NAVICECUTOFF 5.0
```

**ASCII Example:**

```
NAVICECUTOFF 10.0
```

| Field | Field Type          | ASCII Value   | Binary Value | Description  | Format | Binary Bytes | Binary Offset |
|-------|---------------------|---------------|--------------|--|--------|--------------|---------------|
| 1     | NAVICECUTOFF header | -             | -            | Command header. See <i>Messages</i> on page 25 for more information. | -      | H            | 0             |
| 2     | angle               | ±90.0 degrees |              | Elevation cut-off angle relative to horizon                          | Float  | 4            | H             |

## 2.82 NMEAFORMAT

### *Customize NMEA output*

**Platform: OEM719, OEM729, OEM7500, OEM7700, OEM7720, PwrPak7, HxGN PIM7500**

Use the NMEAFORMAT command to customize the NMEA GPGGA and GPGGALONG output.



Modifying the NMEA output will make it not compliant with the NMEA standard.

#### **Message ID: 1861**

#### **Abbreviated ASCII Syntax:**

```
NMEAFORMAT field format
```

#### **Factory Default:**

```
NMEAFORMAT GGA_LATITUDE 9.4
NMEAFORMAT GGA_LONGITUDE 10.4
NMEAFORMAT GGA_ALTITUDE .2
NMEAFORMAT GGALONG_LATITUDE 12.7
NMEAFORMAT GGALONG_LONGITUDE 13.7
NMEAFORMAT GGALONG_ALTITUDE .3
```

#### **Example:**

The following settings increase the precision of the GPGGA latitude and longitude fields:

```
NMEAFORMAT GGA_LATITUDE 11.6
NMEAFORMAT GGA_LONGITUDE 12.6
```

The following settings decrease the precision of the GPGGALONG latitude and longitude fields:

```
NMEAFORMAT GGALONG_LATITUDE 11.6
NMEAFORMAT GGALONG_LONGITUDE 12.6
```

The following setting stops the undulation fields of the GPGGALONG log being filled, making a log like the GPGGARTK log that was in NovAtel's OEM6 firmware:

```
NMEAFORMAT GGALONG_UNDULATION !0
```

| Field | Field Type               | ASCII Value | Binary Value | Description  | Format | Binary Bytes | Binary Offset |
|-------|--------------------------|-------------|--------------|--|--------|--------------|---------------|
| 1     | NMEA<br>FORMAT<br>Header | -           | -            | Command header. See <i>Messages</i> on page 25 for more information. | -      | H            | 0             |

| Field | Field Type | ASCII Value            | Binary Value | Description                       | Format | Binary Bytes | Binary Offset |
|-------|------------|------------------------|--------------|-----------------------------------|--------|--------------|---------------|
| 2     | Field      | GGA_<br>LATITUDE       | 0            | GPGGA latitude field              | Enum   | 4            | H             |
|       |            | GGA_<br>LONGITUDE      | 1            | GPGGA longitude field             |        |              |               |
|       |            | GGA_<br>ALTITUDE       | 2            | GPGGA altitude (height) field     |        |              |               |
|       |            | GGA_<br>UNDULATION     | 3            | GPGGA undulation field            |        |              |               |
|       |            | GGALONG_<br>LATITUDE   | 10           | GPGGALONG latitude field          |        |              |               |
|       |            | GGALONG_<br>LONGITUDE  | 11           | GPGGALONG longitude field         |        |              |               |
|       |            | GGALONG_<br>ALTITUDE   | 12           | GPGGALONG altitude (height) field |        |              |               |
|       |            | GGALONG_<br>UNDULATION | 13           | GPGGALONG undulation field        |        |              |               |

| Field | Field Type | ASCII Value | Binary Value | Description  | Format  | Binary Bytes | Binary Offset |
|-------|------------|-------------|--------------|--|---------|--------------|---------------|
| 3     | Format     | Char[8]     |              | <p>The Format field has a syntax similar to the printf function commonly found in programming languages. The format is:</p> <p style="padding-left: 40px;">!x.y</p> <p>Where:</p> <p><b>y</b> is the number of digits to display after the decimal point</p> <p><b>x</b> sets the minimum field width including the decimal point. X is optional if ! is not used. If the value requires fewer digits than x, leading zeros are added to the output.</p> <p><b>!</b> forces the field width to x. ! is optional. If a value exceeds the permitted width, the value will be saturated. If ! is used, y must be less than x.</p> <p>Examples (GGA_LATITUDE):</p> <p style="padding-left: 40px;">.5 = 5106.98120</p> <p style="padding-left: 40px;">2.3 = 5106.981</p> <p style="padding-left: 40px;">7.1 = 05107.0</p> <p style="padding-left: 40px;">!7.2 = 5106.98</p> <p style="padding-left: 40px;">!7.3 = 999.999</p> | Char[8] | 8            | H+4           |



## 2.83 NMEATALKER

### *Sets the NMEA talker ID*

**Platform: OEM719, OEM729, OEM7500, OEM7700, OEM7720, PwrPak7, HxGN PIM7500**

This command is used to alter the behavior of the NMEA talker ID. The talker is the first 2 characters after the \$ sign in the log header of the GPGLL, GPGRS, GPGSA, GPGST, GPGSV, GPRMB, GPRMC, GPVTG and GPZDA log outputs. The other NMEA logs are not affected by the NMEATALKER command.



On SPAN systems, the GPGGA position is always based on the position solution from the BESTPOS log which incorporate GNSS + INS solutions as well.

The default GPS NMEA messages (**NMEATALKER GP**) include specific information about only the GPS satellites that have a 'GP' talker solution, even when GLONASS satellites are present. As well, the default GPS NMEA message outputs GP as the talker ID regardless of the position type given in position logs such as BESTPOS. The **NMEATALKER AUTO** command changes this behavior so that the NMEA messages include all satellites in the solution and the talker ID changes according to those satellites.

If **NMEATALKER** is set to **auto** and there are both GPS and GLONASS satellites in the solution, two sentences with the GN talker ID are output. The first sentence contains information about the GPS and the second sentence on the GLONASS satellites in the solution.

If **NMEATALKER** is set to **auto** and there are only GLONASS satellites in the solution, the talker ID of this message is GL.



If the solution comes from SPAN, the talker ID is IN.

**Message ID: 861**

**Abbreviated ASCII Syntax:**

```
NMEATALKER id
```

**Factory Default:**

```
NMEATALKER gp
```

**ASCII Example:**

```
NMEATALKER auto
```

| Field | Field Type        | ASCII Value | Binary Value | Description  | Format | Binary Bytes | Binary Offset |
|-------|-------------------|-------------|--------------|--|--------|--------------|---------------|
| 1     | NMEATALKER header | -           | -            | Command header. See <i>Messages</i> on page 25 for more information. | -      | H            | 0             |
| 2     | ID                | GP          | 0            | GPS (GP) only  | Enum   | 4            | H             |
|       |                   | AUTO        | 1            | GPS, Inertial (IN) and/or GLONASS                                    |        |              |               |



The NMEATALKER command only affects NMEA logs that are capable of a GPS output. For example, GLMLA is a GLONASS-only log and the output will always use the GL talker. *Table 50: NMEA Talkers* below shows the NMEA logs and whether they use GPS (GP), GLONASS (GL), Galileo (GA) or combined (GN) talkers with NMEATALKER AUTO.

**Table 50: NMEA Talkers**

| Log   | Talker IDs           |
|-------|----------------------|
| GLMLA | GL                   |
| GPALM | GP                   |
| GPGGA | GP                   |
| GPGLL | GP or GL or GA or GN |
| GPGRS | GP or GL or GA or GN |
| GPGSA | GP or GL or GA or GN |
| GPGST | GP or GL or GA or GN |
| GPGSV | GP and GL and GA     |
| GPRMB | GP or GL or GA or GN |
| GPRMC | GP or GL or GA or GN |
| GPVTG | GP or GL or GA or GN |
| GPZDA | GP                   |

## 2.84 NMEAVERSION

### *Sets the NMEA Version for Output*

**Platform:** OEM719, OEM729, OEM7500, OEM7700, OEM7720, PwrPak7, HxGN PIM7500

Use this command to set the output version of NMEA messages.

**Message ID:** 1574

**Abbreviated ASCII Syntax:**

```
NMEAVERSION Version
```

**Factory Defaults:**

```
NMEAVERSION V31
```

**ASCII Example:**

```
NMEAVERSION V41
```

| Field | Field Type         | ASCII Value | Binary Value | Description  | Format | Binary Bytes | Binary Offset |
|-------|--------------------|-------------|--------------|--|--------|--------------|---------------|
| 1     | NMEAVERSION header | -           | -            | Command header. See <i>Messages</i> on page 25 for more information. | -      | H            | 0             |
| 2     | Version            | V31         | 0            | NMEA messages will be output in NMEA version 3.10 format.            | Enum   | 4            | H             |
|       |                    | V41         | 1            | NMEA messages will be output in NMEA version 4.10 format.            |        |              |               |

## 2.85 NTRIPCONFIG

### *Configures NTRIP*

**Platform: OEM729, OEM7700, OEM7720, PwrPak7**

This command sets up and configures NTRIP communication.

**Message ID: 1249**

#### Abbreviated ASCII Syntax:

```
NTRIPCONFIG port type [protocol [endpoint [mountpoint [username [password
[bindinterface]]]]]]]
```



Mountpoint, username and password are all set up on the caster.

#### Factory Default:

```
NTRIPCONFIG ncom1 disabled
NTRIPCONFIG ncom2 disabled
NTRIPCONFIG ncom3 disabled
NTRIPCONFIG ncomX disabled
```

#### ASCII Example:

```
NTRIPCONFIG ncom1 client v1 :2000 calg0
```

#### ASCII example (NTRIP client):

```
NTRIPCONFIG ncom1 client v2 192.168.1.100:2101 RTCM3 calgaryuser calgarypwd
```

#### ASCII example (NTRIP server):

```
NTRIPCONFIG ncom1 server v1 192.168.1.100:2101 RTCM3 "" casterpwd
```

| Field | Field Type         | ASCII Value | Binary Value | Description   | Format | Binary Bytes | Binary Offset |
|-------|--------------------|-------------|--------------|---|--------|--------------|---------------|
| 1     | NTRIPCONFIG Header | -           | -            | Command header. See <i>Messages</i> on page 25 for more information.              | -      | H            | 0             |
| 2     | port               | THISPORT    | 6            | Name of the port see <i>Table 31: Communications Port Identifiers</i> on page 130 | Enum   | 4            | H             |
|       |                    | NCOM1       | 26           |   |        |              |               |
|       |                    | NCOM2       | 27           |   |        |              |               |
|       |                    | NCOM3       | 28           |   |        |              |               |

| Field | Field Type    | ASCII Value             | Binary Value | Description  | Format      | Binary Bytes  | Binary Offset |
|-------|---------------|-------------------------|--------------|--|-------------|---------------|---------------|
| 3     | type          | DISABLED                | 1            | NTRIP type   | Enum        | 4             | H+4           |
|       |               | CLIENT                  | 2            |  |             |               |               |
|       |               | SERVER                  | 3            |  |             |               |               |
| 4     | protocol      | V1                      | 1            | Protocol (default V1)  | Enum        | 4             | H+8           |
|       |               | V2                      | 2            |  |             |               |               |
| 5     | endpoint      | Max 80 character string |              | Endpoint to wait on or to connect to where host is a hostname or IP address and port is the TCP/UDP port number (default = 80) | String [80] | variable<br>1 | H+12          |
| 6     | mountpoint    | Max 80 character string |              | Which mount point to use   | String [80] | variable<br>1 | variable      |
| 7     | user name     | Max 30 character string |              | Login user name  | String [30] | variable<br>1 | variable      |
| 8     | password      | Max 30 character string |              | Password   | String [30] | variable<br>1 | variable      |
| 9     | bindInterface | ALL (default)           | 1            | Not supported. Set to <i>ALL</i> for future compatibility.   | Enum        | 4             | variable      |

<sup>1</sup>In the binary case, each string field needs to be NULL terminated and additional bytes of padding added to maintain 4-byte alignment, up to the maximum defined by the string size. The next defined field starts immediately at the next 4-byte alignment following the NULL.

## 2.86 NTRIPSOURCETABLE

### Set NTRIPCASTER ENDPONTS

**Platform:** OEM729, OEM7700, OEM7720, PwrPak7

This command is used to set the NTRIPCASTER ENDPONTS to be used for the **SOURCETABLE** log (see page 814).

**Message ID:** 1343

#### Abbreviated ASCII Syntax:

```
NTRIPSOURCETABLE endpoint [reserved1] [reserved2]
```

#### Factory Default:

```
NTRIPSOURCETABLE none
```

#### ASCII Example:

```
NTRIPSOURCETABLE hera.novatel.com:2101
```

```
NTRIPSOURCETABLE 198.161.64.11:2101
```

| Field | Field Type               | ASCII Value             | Binary Value | Description   | Format      | Binary Bytes          | Binary Offset |
|-------|--------------------------|-------------------------|--------------|---|-------------|-----------------------|---------------|
| 1     | NTRIP SOURCETABLE header | -                       |              | Command header. See <i>Messages</i> on page 25 for more information.  | -           | H                     | 0             |
| 2     | Endpoint                 | Max 80 character string |              | Endpoint, in format of host:port, to connect to where the host is a hostname or IP address and port is the TCP/IP port number | String [80] | variable <sup>1</sup> | H             |
| 3     | Reserved1                | Reserved                |              | Reserved  | Ulong       | 4                     | variable      |
| 4     | Reserved2                | Reserved                |              | Reserved  | Ulong       | 4                     | variable      |

<sup>1</sup>In the binary case, each string field needs to be NULL terminated and additional bytes of padding added to maintain 4-byte alignment, up to the maximum defined by the string size. The next defined field starts immediately at the next 4-byte alignment following the NULL.

## 2.87 NVMRESTORE

### *Restores NVM data after an NVM failure*

**Platform: OEM719, OEM729, OEM7500, OEM7700, OEM7720, PwrPak7, HxGN PIM7500**

This command is used to restore Non-Volatile Memory (NVM) data after a NVM Fail error. This failure is indicated by bit 15 of the receiver error word being set (see also **RXSTATUS** command on page 734 and **RXSTATUSEVENT** command on page 749). If corrupt NVM data is detected, the receiver remains in the error state and continues to flash an error code on the Status LED until the **NVMRESTORE** command is issued (refer to the chapter on Built-In Status Tests in the [OEM7 Installation and Operation User Manual](#) for further explanation).

If you have more than one auth code and the saved model is lost, then the model may need to be entered using the **MODEL** command or it is automatically saved in NVM on the next start up. If the almanac was lost, a new almanac is automatically saved when the next complete almanac is received (after approximately 15 minutes of continuous tracking). If the user configuration was lost, it has to be reentered by the user. This could include communication port settings.



The factory default for the COM ports is 9600, n, 8, 1.

After entering the **NVMRESTORE** command and resetting the receiver, the communications link may have to be reestablished at a different baud rate from the previous connection.

**Message ID: 197**

**Abbreviated ASCII Syntax:**

```
NVMRESTORE
```



The possibility of NVM failure is extremely remote, however, if it should occur it is likely that only a small part of the data is corrupt. This command is used to remove the corrupt data and restore the receiver to an operational state. The data lost could be the user configuration, almanac, model or other reserved information.

## 2.88 NVMUSERDATA

### *Write User Data to NVM*

**Platform: OEM719, OEM729, OEM7500, OEM7700, OEM7720, PwrPak7, HxGN PIM7500**

This command writes the data provided in the data array to NVM. This data can be retrieved by issuing the command **LOG NVMUSERDATA**.

The user data is maintained through power cycles and a standard **FRESET** command (see page 170). To clear the user data, use the **FRESET USERDATA** command.



The user data may be deleted if the **NVMRESTORE** command (see page 247) is sent. NVMRESTORE should be used with caution and is meant for use only in the event of a NVM receiver error.

**Message ID: 1970**

**Abbreviated ASCII Syntax:**

NVMUSERDATA N DATA

| Field | Field Type         | Binary Value | Description  | Binary Format | Binary Bytes | Binary Offset |
|-------|--------------------|--------------|--|---------------|--------------|---------------|
| 1     | NVMUSERDATA header | -            | Command header. See <i>Messages</i> on page 25 for more information.   | -             | H            | 0             |
| 2     | N                  | -            | Number of bytes of data to follow  | Ulong         | 4            | H             |
| 3     | DATA               | -            | User input data up to a maximum of 2000 bytes.<br>Data is entered in hexadecimal values with no separators between the values. For example, 1a2b3c4e | Uchar         | 2000         | H+4           |



## 2.89 PDPFILTER

*Enables, disables or resets the PDP filter*

**Platform: OEM719, OEM729, OEM7500, OEM7700, OEM7720, PwrPak7, HxGN PIM7500**

This command is used to enable, disable or reset the Pseudorange/Delta-Phase (PDP) filter. The main advantages of the PDP implementation are:

- Smooths a jumpy position
- Bridges outages in satellite coverage (the solution is degraded from normal but there is at least a reasonable solution without gaps)



Enable the PDP filter to output the PDP solution in the **BESTPOS** log (see page 416), **BESTVEL** log (see page 432) and *NMEA Standard Logs* on page 600.

Refer to the *Operation* chapter of the [OEM7 Installation and Operation User Manual](#) for information on configuring your receiver for PDP or GLIDE™ operation.

### 2.89.1 GLIDE Position Filter

GLIDE is a mode of the PDP<sup>1</sup> filter that optimizes the position for consistency over time rather than absolute accuracy. This is ideal in clear sky conditions where the user needs a tight, smooth and consistent output. The GLIDE filter works best with SBAS. The PDP filter is smoother than a least squares solution but is still noisy in places. The GLIDE filter produces a very smooth solution with relative rather than absolute position accuracy. There should typically be less than 1 centimeter difference in error from epoch to epoch. GLIDE also works in single point and DGPS VBS modes. See also the **PDPMODE** command on page 251 and the **PDPPPOS** log on page 615, **PDPVEL** log on page 619 and **PDPXYZ** log on page 621.

**Message ID: 424**

**Abbreviated ASCII Syntax:**

```
PDPFILTER switch
```

**Factory Default:**

```
PDPFILTER disable
```

**ASCII Example:**

```
PDPFILTER enable
```

<sup>1</sup>Refer also to our application note [APN038 on Pseudorange/Delta-Phase \(PDP\)](#), available on our website at [www.novatel.com/support/search](http://www.novatel.com/support/search).

| Field | Field Type       | ASCII Value | Binary Value | Description  | Format | Binary Bytes | Binary Offset |
|-------|------------------|-------------|--------------|--|--------|--------------|---------------|
| 1     | PDPFILTER header | -           | -            | Command header. See <i>Messages</i> on page 25 for more information.                         | -      | H            | 0             |
| 2     | switch           | DISABLE     | 0            | Disable the PDP filter.  | Enum   | 4            | H             |
|       |                  | ENABLE      | 1            | Enable the PDP filter.   |        |              |               |
|       |                  | RESET       | 2            | Reset the PDP filter. A reset clears the filter memory so that the PDP filter can start over |        |              |               |

## 2.90 PDPMODE

### *Selects the PDP mode and dynamics*

**Platform: OEM719, OEM729, OEM7500, OEM7700, OEM7720, PwrPak7, HxGN PIM7500**

This command is used to select the mode and dynamics of the PDP filter.



The **PDPFILTER ENABLE** command (see the **PDPFILTER** command on page 249) must be entered before the **PDPMODE** command.

It is recommended that the ionotype be left at AUTO when using either normal mode PDP or GLIDE. See also the **SETIONOTYPE** command on page 339.

#### Message ID: 970

#### Abbreviated ASCII Syntax:

```
PDPMODE mode dynamics
```

#### Factory Default:

```
PDPMODE normal auto
```

#### ASCII Example:

```
PDPMODE relative dynamic
```

| Field | Field Type     | ASCII Value | Binary Value | Description  | Format | Binary Bytes | Binary Offset |
|-------|----------------|-------------|--------------|--|--------|--------------|---------------|
| 1     | PDPMODE header | -           | -            | Command header. See <i>Messages</i> on page 25 for more information.   | -      | H            | 0             |
| 2     | mode           | NORMAL      | 0            | In relative mode, GLIDE performance is optimized to obtain a consistent error in latitude and longitude over time periods of 15 minutes or less, rather than to obtain the smallest absolute position error. See also <i>GLIDE Position Filter</i> on page 249 for GLIDE mode additional information | Enum   | 4            | H             |
|       |                | RELATIVE    | 1            |  |        |              |               |
|       |                | GLIDE       | 3            |  |        |              |               |
| 3     | dynamics       | AUTO        | 0            | Auto detect dynamics mode  | Enum   | 4            | H+4           |
|       |                | STATIC      | 1            | Static mode  |        |              |               |
|       |                | DYNAMIC     | 2            | Dynamic mode   |        |              |               |

## 2.91 PGNCONFIG

### Configure NMEA2000 PGNs.

**Platform: OEM719, OEM729, OEM7500, OEM7700, OEM7720, PwrPak7, HxGN PIM7500**

Use this command to configure the PGNs of the proprietary NMEA 2000 fast-packet messages the OEM7 receivers produce.

The receiver must be reset after issuing a **SAVECONFIG** command (see page 311) for all the configuration changes to take affect.

**Message ID: 1892**

#### Abbreviated ASCII Syntax:

```
PGNCONFIG message_id pgn priority
```

#### Factory Default:

```
PGNCONFIG INSPVACMP 130816 7
```

```
PGNCONFIG INSPVASDCMP 130817 7
```

#### ASCII Example:

```
PGNCONFIG INSPVACMP 129500 3
```

This example sets the INSPVACMP message to PGN 129500 with priority 3.

| Field | Field Type       | ASCII Value     | Binary Value | Description  | Format | Binary Bytes | Binary Offset |
|-------|------------------|-----------------|--------------|--|--------|--------------|---------------|
| 1     | PGNCONFIG Header | -               | -            | Command header. See <i>Messages</i> on page 25 for more information. | -      | H            | 0             |
| 2     | message_id       | INSPVACMP       | 1889         | NovAtel message ID   | Ulong  | 4            | H             |
|       |                  | INSPVASDCMP     | 1890         |  |        |              |               |
| 3     | pgn              | 0 to 4294967295 |              | PGN to use for message_id  | Ulong  | 4            | H+4           |
| 4     | priority         | 0 - 7           |              | CAN priority to use  | Uchar  | 1            | H+8           |

## 2.92 POSAVE

### *Implements base station position averaging*

**Platform: OEM719, OEM729, OEM7500, OEM7700, OEM7720, PwrPak7, HxGN PIM7500**

This command implements position averaging for base stations. Position averaging continues for a specified number of hours or until the estimated averaged position error is within specified accuracy limits. Averaging stops when the time limit or the horizontal standard deviation limit or the vertical standard deviation limit is achieved. When averaging is complete, the **FIX POSITION** command is automatically invoked. See the **FIX** command on page 158.

If differential logging is initiated, then issue the **POSAVE** command followed by the **SAVECONFIG** command (see page 311). The receiver averages positions after every power on or reset. It then invokes the **FIX POSITION** command to enable it to send differential corrections.

**Message ID: 173**

#### Abbreviated ASCII Syntax:

```
POSAVE state [maxtime [maxhstd [maxvstd]]]
```

#### Factory Default:

```
POSAVE off
```

#### ASCII Example 1:

```
POSAVE on 24 1 2
```

#### ASCII Example 2:

```
POSAVE OFF
```

| Field | Field Type    | ASCII Value      | Binary Value | Description   | Format | Binary Bytes | Binary Offset |
|-------|---------------|------------------|--------------|---|--------|--------------|---------------|
| 1     | POSAVE header | -                | -            | Command header. See <i>Messages</i> on page 25 for more information.    | -      | H            | 0             |
| 2     | state         | ON               | 1            | Enable position averaging   | Enum   | 4            | H             |
|       |               | OFF              | 0            | Disable position averaging  |        |              |               |
| 3     | maxtime       | 0.01 - 100 hours |              | Maximum amount of time that positions are to be averaged (default=0.01) | Float  | 4            | H+4           |
| 4     | maxhstd       | 0 - 100 m        |              | Desired horizontal standard deviation (default = 0.0)                   | Float  | 4            | H+8           |

| Field | Field Type | ASCII Value | Binary Value | Description  | Format | Binary Bytes | Binary Offset |
|-------|------------|-------------|--------------|--|--------|--------------|---------------|
| 5     | maxvstd    | 0 - 100 m   |              | Desired vertical standard deviation<br>(default = 0.0) | Float  | 4            | H+12          |



The **POSAVE** command can be used to establish a new base station, in any form of survey or RTK data collection, by occupying a site and averaging the position until either a certain amount of time has passed or position accuracy has reached a user specified level. User specified requirements can be based on time or horizontal or vertical quality of precision.

## 2.93 POSTIMEOUT

### *Sets the position time out*

**Platform:** OEM719, OEM729, OEM7500, OEM7700, OEM7720, PwrPak7, HxGN PIM7500

This commands is used to set the time out value for the position calculation in seconds.

In position logs, for example **BESTPOS** log (see page 416) or **PSRPOS** log (see page 634), when the position time out expires, the Position Type field is set to NONE. Other field values in these logs remain populated with the last available position data. Also, the position is no longer used in conjunction with the almanac to determine what satellites are visible.

**Message ID: 612**

#### Abbreviated ASCII Syntax:

```
POSTIMEOUT sec
```

#### Factory Default:

```
POSTIMEOUT 600
```

#### ASCII Example:

```
POSTIMEOUT 1200
```



When performing data collection in a highly dynamic environment (for example, urban canyons or in high speed operations), you can use **POSTIMEOUT** to prevent the receiver from outputting calculated positions that are too old. Use **POSTIMEOUT** to force the receiver position type to NONE. This ensures that the position information being used in the **BESTPOS** log (see page 416) or **PSRPOS** log (see page 634) is based on a recent calculation. All position calculations are then recalculated using the most recent satellite information.

| Field | Field Type        | ASCII Value | Binary Value | Description  | Format | Binary Bytes | Binary Offset |
|-------|-------------------|-------------|--------------|--|--------|--------------|---------------|
| 1     | POSTIMEOUT header | -           | -            | Command header. See <i>Messages</i> on page 25 for more information. | -      | H            | 0             |
| 2     | sec               | 0-86400     |              | Time out in seconds  | Ulong  | 4            | H             |

## 2.94 PPPBASICCONVERGEDCRITERIA

### *Configures decision for PPP Basic convergence*

**Platform: OEM719, OEM729, OEM7500, OEM7700, OEM7720, PwrPak7, HxGN PIM7500**

The **PPPBASICCONVERGEDCRITERIA** command sets the threshold that determines if the solution has converged for lower accuracy PPP solutions. These are the PPP solutions reported with the PPP\_BASIC and PPP\_BASIC\_CONVERGING position types.



The convergence threshold for high-accuracy PPP solutions (reported with PPP and PPP\_CONVERGING position types) is set using the **PPPCONVERGEDCRITERIA** command (see page 257).



Relaxing the convergence threshold shortens the time before a PPP solution is reported as converged. However, it does not alter solution behavior. During the initial PPP solution period, the positions can have decimeter error variation. Only relax the convergence threshold if the application can tolerate higher solution variability.

**Message ID: 1949**

#### Abbreviated ASCII Syntax:

```
PPPBASICCONVERGEDCRITERIA criteria tolerance
```

#### Factory Default:

```
PPPBASICCONVERGEDCRITERIA horizontal_stddev 0.60
```

#### ASCII Example:

```
PPPBASICCONVERGEDCRITERIA total_stddev 0.45
```

| Field | Field Type                         | ASCII Value       | Binary Value | Description  | Format | Binary Bytes | Binary Offset |
|-------|------------------------------------|-------------------|--------------|--|--------|--------------|---------------|
| 1     | PPPBASIC CONVERGED CRITERIA header | -                 | -            | Command header. See <i>Messages</i> on page 25 for more information. | -      | H            | 0             |
| 2     | Criteria                           | TOTAL_STDDEV      | 1            | Use the total, 3D, standard deviation                                | Enum   | 4            | H             |
|       |                                    | HORIZONTAL_STDDEV | 2            | Use the horizontal, 2D, standard deviation                           |        |              |               |
| 3     | Tolerance                          |                   |              | Tolerance (m)  | Float  | 4            | H+4           |



## 2.95 PPPCONVERGEDCRITERIA

### *Configures decision for PPP convergence*

**Platform: OEM719, OEM729, OEM7500, OEM7700, OEM7720, PwrPak7, HxGN PIM7500**

The **PPPCONVERGEDCRITERIA** command sets the threshold that determines if the solution has converged for high-accuracy PPP solutions. These are the PPP solutions reported with the PPP and PPP\_CONVERGING position types.



The convergence threshold for lower accuracy PPP solutions (reported with PPP\_BASIC and PPP\_BASIC\_CONVERGING position types) is set using the **PPPBASICCONVERGEDCRITERIA** command (see page 256).



Relaxing the convergence threshold shortens the time before a PPP solution is reported as converged. However, it does not alter solution behavior. During the initial PPP solution period, the positions can have decimeter error variation. Only relax the convergence threshold if the application can tolerate higher solution variability.

**Message ID: 1566**

#### Abbreviated ASCII Syntax:

```
PPPCONVERGEDCRITERIA criteria tolerance
```

#### Factory Default:

```
PPPCONVERGEDCRITERIA horizontal_stddev 0.32
```

#### ASCII Example:

```
PPPCONVERGEDCRITERIA total_stddev 0.15
```

| Field | Field Type                    | ASCII Value       | Binary Value | Description  | Format | Binary Bytes | Binary Offset |
|-------|-------------------------------|-------------------|--------------|--|--------|--------------|---------------|
| 1     | PPP CONVERGED CRITERIA header | -                 | -            | Command header. See <i>Messages</i> on page 25 for more information. | -      | H            | 0             |
| 2     | Criteria                      | TOTAL_STDDEV      | 1            | Use the total, 3D, standard deviation                                | Enum   | 4            | H             |
|       |                               | HORIZONTAL_STDDEV | 2            | Use the horizontal, 2D, standard deviation                           |        |              |               |
| 3     | Tolerance                     |                   |              | Tolerance (m)  | Float  | 4            | H+4           |

## 2.96 PPPDYNAMICS

### *Sets the PPP dynamics mode*

**Platform:** OEM719, OEM729, OEM7500, OEM7700, OEM7720, PwrPak7, HxGN PIM7500

This command configures the dynamics assumed by the PPP filter. AUTO detects the antenna dynamics and adapts filter operation accordingly.



The automatic dynamics detection may be fooled by very slow, “creeping” motion, where the antenna consistently moves less than 2 cm/s. In such cases, the mode should explicitly be set to DYNAMIC.

**Message ID:** 1551

**Abbreviated ASCII Syntax:**

```
PPPDYNAMICS mode
```

**Factory Default:**

```
PPPDYNAMICS dynamic
```

**ASCII Example:**

```
PPPDYNAMICS auto
```

| Field | Field Type         | ASCII Value | Binary Value | Description  | Format | Binary Bytes | Binary Offset |
|-------|--------------------|-------------|--------------|--|--------|--------------|---------------|
| 1     | PPPDYNAMICS header | -           | -            | Command header. See <i>Messages</i> on page 25 for more information. | -      | H            | 0             |
| 2     | Mode               | AUTO        | 0            | Automatically determines dynamics mode                               | Enum   | 4            | H             |
|       |                    | STATIC      | 1            | Static mode  |        |              |               |
|       |                    | DYNAMIC     | 2            | Dynamic mode   |        |              |               |

## 2.97 PPPDYNAMICSEED

### *Seed the PPP filter in any platform motion state*

**Platform: OEM719, OEM729, OEM7500, OEM7700, OEM7720, PwrPak7, HxGN PIM7500**

This command enables seeding of the PPP engine regardless of the receiver motion state. Accurate seeds can be used to improve initial PPP convergence and re-convergence following signal outages.

The seed position given by the **PPPDYNAMICSEED** command must be in a datum consistent with the PPP corrections that are in use. For NovAtel CORRECT with PPP, the datum is ITRF2008. The dynamic seed's time must refer to receiver time and cannot be more than 15 seconds in the past. A valid PPP solution (the **PPPPOS** log (see page 625) solution status is SOL\_COMPUTED) must have been computed for the same epoch as the seed in order for the seed to be used.

See the **PPPSEED** command on page 262 for stationary-only seeding and for other control over seeding.

**Message ID: 2071**

#### Abbreviated ASCII Syntax:

```
PPPDYNAMICSEED week seconds latitude longitude height northing_std_dev
easting_std_dev height_std_dev [northing_easting_covariance] [northing_
height_covariance] [easting_height_covariance]
```

#### Example :

```
PPPDYNAMICSEED 1817 247603 51.2086442297 -113.9810263055 1071.859 0.02 0.02
0.04
```

| Field | Field Type            | ASCII Value | Binary Value | Description  | Format | Binary Bytes | Binary Offset |
|-------|-----------------------|-------------|--------------|--|--------|--------------|---------------|
| 1     | PPPDYNAMICSEED header | -           | -            | Command header. See <i>Messages</i> on page 25 for more information. |        | H            | 0             |
| 2     | week                  | 0-9999      |              | GPS Week number  | Ulong  | 4            | H             |
| 3     | seconds               | 0-604800    |              | Number of seconds into GPS week                                      | Ulong  | 4            | H+4           |
| 4     | latitude              | ±90         |              | Latitude (degrees)   | Double | 8            | H+8           |
| 5     | longitude             | ±180        |              | Longitude (degrees)  | Double | 8            | H+16          |
| 6     | height                | > -2000.0   |              | Ellipsoidal height (metres)  | Double | 8            | H+24          |

| Field | Field Type                  | ASCII Value | Binary Value | Description   | Format | Binary Bytes | Binary Offset |
|-------|-----------------------------|-------------|--------------|---|--------|--------------|---------------|
| 7     | northing_std_dev            |             |              | Northing standard deviation (metres)                        | Float  | 4            | H+32          |
| 8     | easting_std_dev             |             |              | Easting standard deviation (metres)                         | Float  | 4            | H+36          |
| 9     | height_std_dev              |             |              | Ellipsoidal height standard deviation (metres)              | Float  | 4            | H+40          |
| 10    | northing_easting_covariance |             |              | Covariance between northing and easting components (metres) | Float  | 4            | H+44          |
| 11    | northing_height_covariance  |             |              | Covariance between northing and height components (metres)  | Float  | 4            | H+48          |
| 12    | easting_height_covariance   |             |              | Covariance between easting and height components (metres)   | Float  | 4            | H+52          |

## 2.98 PPPRESET

### *Reset the PPP filter*

**Platform:** OEM719, OEM729, OEM7500, OEM7700, OEM7720, PwrPak7, HxGN PIM7500

This command resets the PPP filter. After a reset, the PPP filter is restored to its initial state and PPP convergence will start over.



If deletion of the NVM-saved PPP seed information is also required, then a **PPPSEED CLEAR** command must be applied before the PPPRESET command. See the **PPPSEED** command on the next page.

**Message ID:** 1542

**Abbreviated ASCII Syntax:**

```
PPPRESET [Option]
```

**ASCII Example :**

```
PPPRESET
```

| Field | Field Type      | ASCII Value | Binary Value | Description  | Binary Bytes | Binary Format | Binary Offset |
|-------|-----------------|-------------|--------------|--|--------------|---------------|---------------|
| 1     | PPPRESET header | -           | -            | Command header. See <i>Messages</i> on page 25 for more information.       | -            | H             | 0             |
| 2     | Option          | FILTER      | 1            | Reset the PPP filter.<br>This is an optional parameter. (default = FILTER) | 4            | Enum          | H             |

## 2.99 PPPSEED

### *Control the seeding of the PPP filter*

**Platform: OEM719, OEM729, OEM7500, OEM7700, OEM7720, PwrPak7, HxGN PIM7500**

The **PPPSEED** command controls the seeding of the PPP filter. Accurate position seeding can accelerate PPP convergence.

**PPPSEED SET** is used to explicitly specify a seed position. The seed position must be in a datum consistent with the PPP corrections that will be used. For NovAtel CORRECT with PPP, this is ITRF2008. The **PPPSEED SET** command can only be used to give seed positions for stationary platforms. If the platform is moving, use the **PPPDYNAMICSEED** command (see page 259).



Caution must be exercised when using **PPPSEED SET**. While a good seed position can accelerate convergence, a bad seed position hurts performance. In some cases, a bad seed can prevent a solution from ever converging to a correct position. In other cases, a bad seed might be rejected immediately. In still other cases, the filter might operate with it for a time period only to reject it later. In this case, the filter position is partially reset, with a corresponding discontinuity in the PPP position.

**PPPSEED STORE** and **RESTORE** are intended to simplify seeding in operations where the antenna does not move between power-down and power-up. For example, in agricultural operations a tractor might be stopped in a field at the end of a day and then re-started the next day in the same position. Before the receiver is powered-down, the current PPP position could be saved to NVM using the **PPPSEED STORE** command, and then that position applied as a seed after power-up using **PPPSEED RESTORE**.

**PPPSEED AUTO** automates the STORE and RESTORE process. When this option is used, the PPP filter automatically starts using the stopping position of the previous day. For this command to work, the **PPPDYNAMICS** command (see page 258) setting must be AUTO so that the receiver can determine when it is static, or the filter must explicitly be told it is static using **PPPDYNAMIC STATIC**. Additionally, in order for the receiver to recall the saved seed, the **PPPSEED AUTO** command should be saved to NVM using the **SAVECONFIG** command (see page 311).

**Message ID: 1544**

#### **Abbreviated ASCII Syntax:**

```
PPPSEED option [latitude] [longitude] [height] [northing_std._dev.]
[easting_std._dev.] [height_std._dev.]
```

#### **ASCII Example:**

```
PPPSEED set 51.11635322441 -114.03819311672 1064.5458 0.05 0.05 0.05
```

| Field | Field Type         | ASCII Value | Binary Value | Description  | Format | Binary Bytes | Binary Offset |
|-------|--------------------|-------------|--------------|--|--------|--------------|---------------|
| 1     | PPPSEED header     | -           | -            | Command header. See <i>Messages</i> on page 25 for more information.                               | -      | H            | 0             |
| 2     | option             | CLEAR       | 0            | Resets the stored seed, and prevents any auto seeding from occurring.                              | Enum   | 4            | H             |
|       |                    | SET         | 1            | Immediately apply the specified co-ordinates as a seed position.                                   |        |              |               |
|       |                    | STORE       | 2            | Store the current PPP position in NVM for use as a future seed.                                    |        |              |               |
|       |                    | RESTORE     | 3            | Retrieve and apply a seed position that was previously saved in NVM via the STORE or AUTO options. |        |              |               |
|       |                    | AUTO        | 4            | Automatically store and restore PPP seed positions.  |        |              |               |
| 3     | latitude           | ±90         |              | Latitude (degrees)   | Double | 8            | H+4           |
| 4     | longitude          | ±180        |              | Longitude (degrees)  | Double | 8            | H+12          |
| 5     | height             | > -2000.0   |              | Ellipsoidal height (metres)  | Double | 8            | H+20          |
| 6     | northing std. dev. |             |              | Northing standard deviation (metres)   | Float  | 4            | H+28          |
| 7     | easting std. dev.  |             |              | Easting standard deviation (metres)  | Float  | 4            | H+32          |
| 8     | height std. dev.   |             |              | Ellipsoidal height standard deviation (metres)   | Float  | 4            | H+36          |
| 9     | Reserved           |             |              |  | Float  | 4            | H+40          |

## 2.100 PPPSOURCE

*Specifies the PPP correction source*

**Platform:** OEM719, OEM729, OEM7500, OEM7700, OEM7720, PwrPak7, HxGN PIM7500

This command determines what corrections the PPP filter will use. When transitioning between explicitly specified sources, there can be some delay between this command being accepted and the source specified in the PPP solution changing.



The AUTO source behavior is subject to change.

**Message ID:** 1707

**Abbreviated ASCII Syntax:**

```
PPPSOURCE source
```

**Factory Default:**

```
PPPSOURCE auto
```

**ASCII Example:**

```
PPPSOURCE none
```

| Field | Field Type       | ASCII Value | Binary Value | Description  | Format | Binary Bytes | Binary Offset |
|-------|------------------|-------------|--------------|--|--------|--------------|---------------|
| 1     | PPPSOURCE header | -           | -            | Command header. See <i>Messages</i> on page 25 for more information. | -      | H            | 0             |



| Field | Field Type | ASCII Value | Binary Value | Description   | Format | Binary Bytes | Binary Offset |
|-------|------------|-------------|--------------|---|--------|--------------|---------------|
| 2     | source     | NONE        | 0            | Reject all PPP corrections.<br>Disable the PPP filter | Enum   | 4            | H             |
|       |            | TERRASTAR   | 1            | Only accept TerraStar PPP corrections                 |        |              |               |
|       |            | VERIPOS     | 2            | Only accept Veripos PPP corrections                   |        |              |               |
|       |            | TERRASTAR_L | 8            | Only accept TerraStar-L PPP corrections               |        |              |               |
|       |            | TERRASTAR_C | 10           | Only accept TerraStar-C PPP corrections               |        |              |               |
|       |            | AUTO        | 100          | Automatically select and use the best corrections     |        |              |               |

## 2.101 PPPTIMEOUT

*Sets the maximum age of the PPP corrections*

**Platform:** OEM719, OEM729, OEM7500, OEM7700, OEM7720, PwrPak7, HxGN PIM7500

This command sets the maximum age of the corrections used in the PPP filter. Corrections older than the specified duration are not applied to the receiver observations and uncorrected observations are not used in the filter.

**Message ID:** 1560

**Abbreviated ASCII Syntax:**

```
PPPTIMEOUT delay
```

**Factory Default:**

```
PPPTIMEOUT 360
```

**ASCII Example:**

```
PPPTIMEOUT 120
```

| Field | Field Type        | ASCII Value | Binary Value | Description  | Format | Binary Bytes | Binary Offset |
|-------|-------------------|-------------|--------------|--|--------|--------------|---------------|
| 1     | PPPTIMEOUT header | -           | -            | Command header. See <i>Messages</i> on page 25 for more information. | -      | H            | 0             |
| 2     | delay             | 5 to 900 s  |              | Maximum corrections age  | Ulong  | 4            | H             |

## 2.102 PPSCONTROL

### *Controls the PPS output*

**Platform: OEM719, OEM729, OEM7500, OEM7700, OEM7720, PwrPak7, HxGN PIM7500**

This command provides a method for controlling the polarity, period and pulse width of the PPS output on the OEM7. The PPS output can also be disabled using this command.



This command is used to setup the PPS signal coming from the receiver. For example, to take measurements such as temperature or pressure, in synch with your GNSS data, the PPS signal can be used to trigger measurements in other devices.

The leading edge of the 1 PPS pulse is always the trigger/reference. For example:

```
PPSCONTROL ENABLE NEGATIVE
```

generates a normally high, active low pulse with the falling edge as the reference, while:

```
PPSCONTROL ENABLE POSITIVE
```

generates a normally low, active high pulse with the rising edge as the reference.

The pulse width is user-adjustable. The adjustable pulse width feature supports triggers/systems that need longer, or shorter, pulse widths than the default to register the pulse enabling a type of GPIO line for manipulation of external hardware control lines.

The switch states allow more control over disabling/enabling the PPS. The ENABLE\_FINETIME switch prevents the PPS from being enabled until FINE or FINESTEERING time status has been reached. The ENABLE\_FINETIME\_MINUTEALIGN switch is similar to ENABLE\_FINETIME with caveat that the PPS will still not be enabled until the start of the next 60 seconds (a 1 minute modulus) after FINE or FINESTEERING time status has been reached.



If the value of a field shared with PPSCONTROL2 is changed in PPSCONTROL, the value of that field is also changed in PPSCONTROL2. For example, if the polarity is changed using the PPSCONTROL command, the polarity is also changed in PPSCONTROL2 command.

**Message ID: 613**

**Abbreviated ASCII Syntax:**

```
PPSCONTROL [switch [polarity [period [pulsewidth]]]]
```

**Factory Default:**

```
PPSCONTROL enable negative 1.0 1000
```

**ASCII Example:**

```
PPSCONTROL enable positive 0.5 2000
```

| Field | Field Type        | ASCII Value                                      | Binary Value | Description  | Format | Binary Bytes | Binary Offset |
|-------|-------------------|--|--------------|--|--------|--------------|---------------|
| 1     | PPSCONTROL header | -  | -            | Command header. See <i>Messages</i> on page 25 for more information.   | -      | H            | 0             |
| 2     | switch            | DISABLE  | 0            | Disable the PPS  | Enum   | 4            | H             |
|       |                   | ENABLE   | 1            | Enable the PPS (default)   |        |              |               |
|       |                   | ENABLE_FINETIME                                  | 2            | Enable the PPS only when FINE or FINESTEERING time status has been reached   |        |              |               |
|       |                   | ENABLE_FINETIME_MINUTEALIGN                      | 3            | Enable the PPS only when FINE or FINESTEERING time status has been reached AND the start of the next 60 seconds (1 minute modulus) has occurred                                    |        |              |               |
| 3     | polarity          | NEGATIVE   | 0            | Optional field to specify the polarity of the pulse to be generated on the PPS output. See <i>Figure 6: TTL Pulse Polarity</i> on page 228 for more information (default=NEGATIVE) | Enum   | 4            | H+4           |
|       |                   | POSITIVE   | 1            |  |        |              |               |
| 4     | period            | 0.05, 0.1, 0.2, 0.25, 0.5, 1.0, 2.0, 3.0,...20.0 |              | Optional field to specify the period of the pulse, in seconds (default=1.0)  | Double | 8            | H+8           |

| Field | Field Type | ASCII Value | Binary Value | Description   | Format | Binary Bytes | Binary Offset |
|-------|------------|-------------|--------------|---|--------|--------------|---------------|
| 5     | pulsewidth |             |              | Optional field to specify the pulse width of the PPS signal in microseconds. This value should always be less than or equal to half the period (default=1000) | Ulong  | 4            | H+16          |

## 2.103 PPSCONTROL2

**Controls polarity, period, pulse width and estimated error limit of the PPS output**

**Platform: OEM719, OEM729, OEM7500, OEM7700, OEM7720, PwrPak7, HxGN PIM7500**

The **PPSCONTROL2** command provides a method for controlling the polarity, period, pulse width, and estimated error limit of the PPS output on the OEM7. The PPS output can also be disabled using this command.

This command is identical to the **PPSCONTROL** command (see page 267) with the addition of a new parameter that represents the Estimated Error Limit.



If the value of a field shared with PPSCONTROL is changed in PPSCONTROL2, the value of that field is also changed in PPSCONTROL. For example, if the polarity is changed using the PPSCONTROL2 command, the polarity is also changed in PPSCONTROL command.

The estimated error limit sets an allowable  $\pm$  range for the clock offset. The PPS output is only enabled when the clock offset is within this range.

**Message ID: 1740**

**Abbreviated ASCII Syntax:**

```
PPSCONTROL2 [switch [polarity [period [pulsewidth [estimatederrorlimit]]]]]
```

**Factory default:**

```
PPSCONTROL2 enable negative 1.0 1000 0
```

**ASCII Example:**

```
PPSCONTROL2 enable_finetime positive 0.5 2000 10
```

| Field | Field Type         | ASCII Value | Binary Value | Description  | Format | Binary Bytes | Binary Offset |
|-------|--------------------|-------------|--------------|--|--------|--------------|---------------|
| 1     | PPSCONTROL2 header | -           | -            | Command header. See <i>Messages</i> on page 25 for more information. | -      | H            | 0             |

| Field | Field Type | ASCII Value                                      | Binary Value | Description   | Format | Binary Bytes | Binary Offset |
|-------|------------|--|--------------|---|--------|--------------|---------------|
| 2     | switch     | DISABLE  | 0            | Disable the PPS   | Enum   | 4            | H             |
|       |            | ENABLE   | 1            | Enable the PPS (default)  |        |              |               |
|       |            | ENABLE_FINETIME                                  | 2            | Enable the PPS only when FINE or FINESTEERING time status has been reached  |        |              |               |
|       |            | ENABLE_FINETIME_MINUTEALIGN                      | 3            | Enable the PPS only when FINE or FINESTEERING time status has been reached AND the start of the next 60 seconds (1 minute modulus) has occurred                                       |        |              |               |
| 3     | polarity   | NEGATIVE   | 0            | Optional field to specify the polarity of the pulse to be generated on the PPS output. See <i>Figure 6: TTL Pulse Polarity</i> on page 228 for more information (default = NEGATIVE). | Enum   | 4            | H+4           |
|       |            | POSITIVE   | 1            |   |        |              |               |
| 4     | period     | 0.05, 0.1, 0.2, 0.25, 0.5, 1.0, 2.0, 3.0,...20.0 |              | Optional field to specify the period of the pulse in seconds (default = 1.0).   | Double | 8            | H+8           |

| Field | Field Type            | ASCII Value | Binary Value | Description  | Format | Binary Bytes | Binary Offset |
|-------|-----------------------|-------------|--------------|--|--------|--------------|---------------|
| 5     | pulse width           |             |              | Optional field to specify the pulse width of the PPS signal in microseconds. This value should always be equal to half the period (default = 1000).  | Ulong  | 4            | H+16          |
| 6     | estimated error limit |             |              | Optional field to specify the $\pm$ estimated error limit (in nanoseconds) for the clock offset (default = 0). The PPS output is only enabled when the clock offset is within this limit.<br><br>An estimated error limit of 0 removes the estimated error limit restraint on the PPS. | Long   | 4            | H+20          |



## 2.104 PROFILE

### *Profile in Non-Volatile Memory (NVM)*

**Platform: OEM719, OEM729, OEM7500, OEM7700, OEM7720, PwrPak7, HxGN PIM7500**

This command is used to configure multiple profiles in the NVM at receiver startup. The output is in the **PROFILEINFO** log (see page 629).

**Message ID: 1411**

#### **Abbreviated ASCII Syntax:**

```
PROFILE Option Name [command]
```

#### **ASCII Examples:**

```
PROFILE create Base
PROFILE createelement Base "log com1 versiona"
PROFILE createelement Base "serialconfig com2 115200"
PROFILE createelement Base "log com2 rtca1 ontime 1"
PROFILE activate Base
```

| Field | Field Type     | ASCII Value   | Binary Value | Description  | Format           | Binary Bytes  | Binary Offset |
|-------|----------------|---|--------------|--|------------------|---------------|---------------|
| 1     | PROFILE header | -   | -            | Command header. See <i>Messages</i> on page 25 for more information. | -                | H             | 0             |
| 2     | Option         | Refer to <i>Table 51: Profile Option</i> on the next page |              | Profile options  | Enum             | 4             | H             |
| 3     | Name           |   |              | Profile name   | String [Max 20]  | variable<br>1 | H+4           |
| 4     | Command        |   |              | Profile command  | String [Max 200] | variable<br>1 | variable      |

<sup>1</sup>In the binary case, each string field needs to be NULL terminated and additional bytes of padding added to maintain 4-byte alignment, up to the maximum defined by the string size. The next defined field starts immediately at the next 4-byte alignment following the NULL.

**Restrictions:**

1. Only supports up to a maximum of 9 profiles.
2. Only supports up to a maximum of 20 commands per profile.
3. Only supports up to a maximum of 200 characters long for each command.
4. Only supports up to a maximum of 1500 characters for all commands in one profile.
5. If one of the profiles is activated, the **SAVECONFIG** functionality is disabled.
6. All profiles are deleted by a FRESET PROFILEINFO command (see the **FRESET** command on page 170).
7. The receiver resets after a profile is activated.
8. Some commands optionally accept a port parameter and will default to THISPORT if no port is provided (e.g. **LOG** command). Since the commands in a profile are not sent from a port THISPORT is undefined in this case. When adding such commands to a profile, be sure to specify the port for the command rather than letting the command use the default, which may result in incorrect behavior.
9. Commands that lead to a reset of the receiver are rejected by the **PROFILE** command (see page 273).

**Table 51: Profile Option**

| Binary | ASCII         | Description                                       |
|--------|---------------|---|
| 0      | Reserved      |   |
| 1      | CREATE        | Create a profile                                  |
| 2      | DELETE        | Delete an existing profile                        |
| 3      | CREATEELEMENT | Create an element in an existing profile          |
| 4      | DELETEELEMENT | Delete an existing element in an existing profile |
| 5      | ACTIVATE      | Activate an existing profile                      |
| 6      | DEACTIVATE    | Deactivate a running profile                      |

## 2.105 PSRDIFFSOURCE

*Sets the pseudorange differential correction source*

**Platform: OEM719, OEM729, OEM7500, OEM7700, OEM7720, PwrPak7, HxGN PIM7500**

This command is used to identify which base station to accept differential corrections from. This is useful when the receiver is receiving corrections from multiple base stations. See also the **RTKSOURCE** command on page 306.



1. When a valid **PSRDIFFSOURCE** command is received, the current correction is removed immediately rather than in the time specified in the (**PSRDIFFSOURCETIMEOUT** command (see page 278)).
2. To use L-Band differential corrections, an L-Band receiver and NovAtel Correct with PPP service or use of a DGPS service is required. Contact NovAtel for details.
3. For ALIGN users: the ALIGN rover will not use RTK corrections automatically to do PSRDIFF positioning, as ALIGN is commonly used with a moving base. If you have a static base and want a PSRDIFF position, at the ALIGN rover, set the PSRDIFFSOURCE to RTK.

**Message ID: 493**

**Abbreviated ASCII Syntax:**

```
PSRDIFFSOURCE type [id]
```

**Factory Default:**

```
PSRDIFFSOURCE auto ANY
```

**ASCII Examples:**

1. Enable only SBAS:

```
RTKSOURCE NONE
PSRDIFFSOURCE SBAS
SBASCONTROL ENABLE AUTO
```

2. Enable RTK and PSRDIFF from RTCM, with a fall-back to SBAS:

```
RTKSOURCE RTCM ANY
PSRDIFFSOURCE RTCM ANY
SBASCONTROL ENABLE AUTO
```

3. Disable all corrections:

```
RTKSOURCE NONE
PSRDIFFSOURCE none
```



Since several errors affecting signal transmission are nearly the same for two receivers near each other on the ground, a base at a known location can monitor the errors and generate corrections for the rover to use. This method is called Differential GPS and is used by surveyors to obtain submetre accuracy.

Major factors degrading GPS signals, which can be removed or reduced with differential methods, are atmospheric, satellite orbit errors and satellite clock errors. Errors not removed include receiver noise and multipath.

| Field | Field Type           | ASCII Value                          | Binary Value | Description  | Format  | Binary Bytes   | Binary Offset |
|-------|----------------------|--------------------------------------|--------------|--|---------|----------------|---------------|
| 1     | PSRDIFFSOURCE header | -                                    | -            | Command header. See <i>Messages</i> on page 25 for more information.   | -       | H              | 0             |
| 2     | type                 | See <i>Table 52: DGPS Type</i> below |              | ID Type. All types (except NONE) may revert to SBAS (if enabled) or SINGLE position types. See <i>Table 74: Position or Velocity Type</i> on page 420 <sup>1</sup> | Enum    | 4              | H             |
| 3     | Base station ID      | Char [5] or ANY                      |              | ID string  | Char[5] | 8 <sup>2</sup> | H+4           |

**Table 52: DGPS Type**

| Binary | ASCII            | Description   |
|--------|------------------|---|
| 0      | RTCM             | RTCM ID: $0 \leq \text{RTCM ID} \leq 1023$ <b>or</b> ANY  |
| 1      | RTCA             | RTCA ID: A four character string containing only alpha (a-z) or numeric characters (0-9) or ANY |
| 2      | CMR <sup>3</sup> | CMR ID: $0 \leq \text{CMR ID} \leq 31$ <b>or</b> ANY  |
| 3      | Reserved         |   |
| 4      | Reserved         |   |

<sup>1</sup>If ANY is chosen, the receiver ignores the ID string. Specify a Type when using base station IDs.

<sup>2</sup>In the binary log case, an additional 3 bytes of padding are added to maintain 4-byte alignment.

<sup>3</sup>This cannot be used in the **PSRDIFFSOURCE** command.

| Binary | ASCII                  | Description  |
|--------|------------------------|--|
| 5      | SBAS <sup>1</sup>      | In the <b>PSRDIFFSOURCE</b> command, when enabled, SBAS such as WAAS, EGNOS and MSAS, forces the use of SBAS as the pseudorange differential source. SBAS is able to simultaneously track two SBAS satellites and incorporate the SBAS corrections into the position to generate differential quality position solutions. An SBAS-capable receiver permits anyone within the area of coverage to take advantage of its benefits.<br><br>If SBAS is set in the <b>RTKSOURCE</b> command (see page 306), it can not provide carrier phase positioning and returns an error |
| 6      | RTK <sup>4</sup>       | In the <b>PSRDIFFSOURCE</b> command, RTK enables using RTK correction types for PSRDIFF positioning. The correction type used is determined by the setting of the <b>RTKSOURCE</b> command (see page 306)  |
| 10     | AUTO <sup>4</sup>      | In the <b>PSRDIFFSOURCE</b> command, AUTO means that if any correction format is received then it will be used. If multiple correction formats are available, then RTCMV3 and RTK will be preferred over SBAS messages. If RTCMV3 and RTK are all available then the type of the first received message will be used.<br><br>In the <b>RTKSOURCE</b> command (see page 306), AUTO means that both the NovAtel RTK filter is enabled. The NovAtel RTK filter selects the first received RTCMV3 message.   |
| 11     | NONE <sup>4</sup>      | Disables all differential correction types   |
| 12     | Reserved               |  |
| 13     | RTCMV3 <sup>3, 2</sup> | RTCM Version 3.0 ID: $0 \leq \text{RTCMV3 ID} \leq 4095$ <b>or</b> ANY   |
| 14     | NOVATELX               | NovAtel proprietary message format ID: A four character string containing alpha (a-z) or numeric characters (0-9) or ANY   |



All **PSRDIFFSOURCE** entries fall back to SBAS (except NONE).

<sup>1</sup>Available only with the **PSRDIFFSOURCE** command.

<sup>2</sup>Base station ID parameter is ignored.

## 2.106 PSRDIFFSOURCE TIMEOUT

*Sets pseudorange differential correction source timeout*

**Platform:** OEM719, OEM729, OEM7500, OEM7700, OEM7720, PwrPak7, HxGN PIM7500

When multiple differential correction sources are available, this command allows the user to set a time in seconds, that the receiver will wait before switching to another differential source, if corrections from the original source are lost.

**Message ID:** 1449

### Abbreviated ASCII Syntax:

```
PSRDIFFSOURCE TIMEOUT option [timeout]
```

### Factory Default:

```
PSRDIFFSOURCE TIMEOUT AUTO
```

### ASCII Example:

```
PSRDIFFSOURCE TIMEOUT auto
```

```
PSRDIFFSOURCE TIMEOUT set 180
```

| Field | Field Type                   | ASCII Value   | Binary Value | Description  | Format | Binary Bytes | Binary Offset |
|-------|------------------------------|---------------|--------------|--|--------|--------------|---------------|
| 1     | PSRDIFFSOURCE TIMEOUT header | -             | -            | Command header. See <i>Messages</i> on page 25 for more information. | -      | H            | 0             |
| 2     | option                       | AUTO          | 1            | Use AUTO or SET to set the time                                      | Enum   | 4            | H             |
|       |                              | SET           | 2            |  |        |              |               |
| 3     | timeout                      | 0 to 3600 sec |              | Specify the timeout (default=0)                                      | Ulong  | 4            | H+4           |

## 2.107 PSRDIFFTIMEOUT

*Sets maximum age of pseudorange differential data*

**Platform:** OEM719, OEM729, OEM7500, OEM7700, OEM7720, PwrPak7, HxGN PIM7500

This command is used to set the maximum age of pseudorange differential correction data to use when operating as a rover station. Received pseudorange differential correction data, older than the specified time, is ignored. This time out period also applies to differential corrections generated from RTK corrections.



The RTCA Standard for scat-i stipulates that the maximum age of differential correction messages cannot be greater than 22 seconds. Therefore, for RTCA rover users, the recommended PSRDIFF delay setting is 22.

**Message ID:** 1450

**Abbreviated ASCII Syntax:**

```
PSRDIFFTIMEOUT delay
```

**Factory Default:**

```
PSRDIFFTIMEOUT 300
```

**ASCII Example:**

```
PSRDIFFTIMEOUT 60
```

| Field | Field Type             | ASCII Value | Binary Value | Description  | Format | Binary Bytes | Binary Offset |
|-------|------------------------|-------------|--------------|--|--------|--------------|---------------|
| 1     | PSRDIFF TIMEOUT header | -           | -            | Command header. See <i>Messages</i> on page 25 for more information. | -      | H            | 0             |
| 2     | delay                  | 2 to 1000 s |              | Maximum pseudorange differential age                                 | Ulong  | 4            | H             |

## 2.108 QZSSECUTOFF

### *Sets QZSS satellite elevation cutoff*

**Platform: OEM719, OEM729, OEM7500, OEM7700, OEM7720, PwrPak7, HxGN PIM7500**

This command is used to set the elevation cut-off angle for tracked QZSS satellites. The receiver does not start automatically searching for a QZSS satellite until it rises above the cut-off angle (when satellite position is known). Tracked satellites that fall below the cut-off angle are no longer tracked unless they are manually assigned (see the **ASSIGN** command on page 66).

In either case, satellites below the QZSSECUTOFF angle are eliminated from the internal position and clock offset solution computations.

This command permits a negative cut-off angle; it could be used in these situations:

- The antenna is at a high altitude, and thus can look below the local horizon
- Satellites are visible below the horizon due to atmospheric refraction



Care must be taken when using **QZSSECUTOFF** command because the signals from lower elevation satellites are traveling through more atmosphere and are therefore degraded. Use of satellites below 5 degrees is not recommended.



Use the **ELEVATIONCUTOFF** command (see page 134) to set the cut-off angle for any system.



For dual antenna receivers, this command applies to both the primary and secondary antennas.

**Message ID: 1350**

**Abbreviated ASCII Syntax:**

```
QZSSECUTOFF angle
```

**Factory Default:**

```
QZSSECUTOFF 5.0
```

**ASCII Example**

```
QZSSECUTOFF 10.0
```



| Field | Field Type         | ASCII Value | Binary Value | Description  | Format | Binary Bytes | Binary Offset |
|-------|--------------------|-------------|--------------|--|--------|--------------|---------------|
| 1     | QZSSECUTOFF header | -           | -            | Command header. See <i>Messages</i> on page 25 for more information. | -      | H            | 0             |
| 2     | angle              | ±90 degrees |              | Elevation cutoff angle relative to the horizon                       | Float  | 4            | H             |

## 2.109 RADARCONFIG

### Configure the Emulated Radar Output

**Platform:** OEM719, OEM729, OEM7500, OEM7700, OEM7720, PwrPak7, HxGN PIM7500

Use this command to configure the Emulated Radar (ER) output.



The ER signal is output on the **VARF** or **EVENT\_OUT1** pin of the receiver.

**Message ID:** 1878

#### Abbreviated ASCII Syntax:

```
RADARCONFIG switch [frequency_step [update_rate [response_mode
[threshold]]]]
```

#### Factory Default:

```
radarconfig disable
```

#### ASCII Example:

```
radarconfig enable 26.11 5hz 2 3.5
```

| Field | Field Type         | ASCII Value  | Binary Value | Description  | Format | Binary Bytes | Binary Offset |
|-------|--------------------|--|--------------|--|--------|--------------|---------------|
| 1     | RADARCONFIG header | -  | -            | Command header. See <i>Messages</i> on page 25 for more information. | -      | H            | 0             |
| 2     | switch             | DISABLE  | 0            | Disables radar emulation (default = disable)                         | Enum   | 4            | H             |
|       |                    | ENABLE   | 1            | Enables radar emulation  |        |              |               |
| 3     | freq_step          | 10.06<br>16.32<br>26.11<br>28.12<br>34.80<br>36.11 |              | Frequency step per kilometer per hour. (default = 36.11 Hz/kph)      | Double | 8            | H+4           |

| Field | Field Type  | ASCII Value                               | Binary Value | Description   | Format  | Binary Bytes | Binary Offset |
|-------|-------------|---|--------------|---|---------|--------------|---------------|
| 4     | update_rate | 1HZ                                       | 1            | Rate at which the output frequency is adjusted<br>(default = 10HZ) <sup>1</sup>   | Enum    | 4            | H+12          |
|       |             | 2HZ                                       | 2            |   |         |              |               |
|       |             | 5HZ                                       | 5            |   |         |              |               |
|       |             | 10HZ                                      | 10           |   |         |              |               |
|       |             | 20HZ                                      | 20           |   |         |              |               |
| 5     | resp_mode   | See <i>Table 53: Response Modes</i> below |              | Specify how responsive radar emulation is to changes in velocity<br>(Default = 500) <sup>1</sup>  | Integer | 4            | H+16          |
| 6     | threshold   | 2 to 50 kph                               |              | The speed threshold at which to switch between response mode 1000 and response mode 500.<br>The threshold is only applicable when the response mode is set to 2.<br>(default = 5 kph) | Double  | 8            | H+20          |

**Table 53: Response Modes**

| Mode | Description  |
|------|--|
| 1    | Immediate. This results in the lowest latency at the cost of higher noise  |
| 2    | Automatically switch between 1000 and 500 depending on speed. When speed is below the Threshold parameter, use Response Mode 500. Otherwise, use Response Mode 1000. |
| 500  | Signal is minimally smoothed resulting in low latency but increased noise.   |
| 1000 | Output signal is smoothed over a smaller window resulting in less latency than 2000 and less noise than 500.   |
| 2000 | Output signal is smoothed to reduce noise at the cost of higher latency  |

<sup>1</sup>The number of samples used for smoothing depends on both the update\_rate and resp\_mode parameters. For instance, if the update\_rate is 5 Hz and the resp\_mode is 2000 ms, the number of samples used will be 10.

## 2.110 RAIMMODE

### *Configures RAIM mode*

**Platform: OEM719, OEM729, OEM7500, OEM7700, OEM7720, PwrPak7, HxGN PIM7500**

This command is used to configure Receiver Autonomous Integrity Monitoring (RAIM) operation. This command uses RTCA MOPS characteristics which defines the positioning accuracy requirements for airborne lateral navigation (LNAV) and vertical navigation (VNAV) at 3 stages of flight:

1. En route travel
2. Terminal (within range of air terminal)
3. Non-precision approach

In order to ensure that the required level of accuracy is available in these phases of flight, MOPS requires the computation of protection levels (HPL and VPL). MOPS has the following definitions that apply to NovAtel's RAIM feature:

**Horizontal Protection Level (HPL)** is a radius of the circle in the horizontal plane. Its center is at the true position, that describes the region, assured to contain the indicated horizontal position. It is the horizontal region where the missed alert and false alert requirements are met using autonomous fault detection.

**Vertical Protection Level (VPL)** is half the length of the segment on the vertical axis. Its center is at the true position, that describes the region, assured to contain the indicated vertical position when autonomous fault detection is used.

**Horizontal Alert Limit (HAL)** is a radius of the circle in the horizontal plane. Its center is at the true position, that describes the region, required to contain the indicated horizontal position with the required probability.

**Vertical Alert Limit (VAL)** is half the length of the segment on the vertical axis. Its center is at the true position, that describes the region, required to contain the indicated vertical position with certain probability.

**Probability of False Alert ( $P_{fa}$ )** is a false alert defined as the indication of a positioning failure, when a positioning failure has not occurred (as a result of false detection). A false alert would cause a navigation alert.

### **2.110.1 Detection strategy**

NovAtel's RAIM detection strategy uses the weighted Least-Squares Detection (LSA) method. This method computes a solution using a LSA and is based on the sum of squares of weighted residuals. It is a comparison between a root sum of squares of residuals and a decision threshold to determine a pass/fail decision.

### **2.110.2 Isolation strategy**

NovAtel RAIM uses the maximum residual method. Logically it is implemented as a second part of Fault Detection and Exclusion (FDE) algorithm for LSA detection method. Weighted LSA residuals are standardized individually and the largest residual is compared to a decision threshold. If it is more than the threshold, the observation corresponding to this residual is declared faulty.

**Message ID: 1285**

**Abbreviated ASCII Syntax:**

```
RAIMMODE mode [hal [val [pfa]]]
```

**Factory Default:**

```
RAIMMODE default
```

**Input Example:**

```
RAIMMODE user 100 100 0.01
```

```
RAIMMODE terminal
```

| Field | Field Type      | ASCII Value                                | Binary Value | Description  | Format | Binary Bytes | Binary Offset |
|-------|-----------------|--|--------------|--|--------|--------------|---------------|
| 1     | RAIMMODE Header | -  | -            | Command header. See <i>Messages</i> on page 25 for more information. | -      | H            | 0             |
| 2     | MODE            | See <i>Table 54: RAIM Mode Types</i> below |              |  | Enum   | 4            | H             |
| 3     | HAL             | $5 \leq \text{HAL} \leq 9999.99$           |              | Horizontal alert limit (m) (Default = 0.0)                           | Double | 8            | H+4           |
| 4     | VAL             | $5 \leq \text{VAL} \leq 9999.99$           |              | Vertical alert limit (m) (Default = 0.0)                             | Double | 8            | H+12          |
| 5     | PFA             | $(P_{fa}) = 1e^{-7} \leq P_{fa} \leq 0.25$ |              | Probability of false alert (Default = 0.0)                           | Double | 8            | H+20          |

**Table 54: RAIM Mode Types**

| Binary | ASCII    | Description   |
|--------|----------|---|
| 0      | DISABLE  | Do not do integrity monitoring of least squares solution  |
| 1      | USER     | User will specify alert limits and probability of false alert   |
| 2      | DEFAULT  | Use NovAtel RAIM (default)  |
| 3      | APPROACH | Default numbers for non-precision approach navigation modes are used - HAL = 556 m (0.3 nm), VAL = 50 m for LNAV/VNAV |
| 4      | TERMINAL | Default numbers for terminal navigation mode are used - HAL = 1855 m (1 nm), no VAL requirement                       |
| 5      | ENROUTE  | Default numbers for enroute navigation mode are used - HAL = 3710 m (2 nm), no VAL requirement                        |

## 2.111 REFERENCESTATIONTIMEOUT

*Sets timeout for removing previously stored base stations*

**Platform:** OEM719, OEM729, OEM7500, OEM7700, OEM7720, PwrPak7, HxGN PIM7500

This command sets how long the receiver will retain RTK base station co-ordinates. Shorter durations might be required if the receiver is operating in a VRS RTK network that recycles base station IDs quickly.

**Message ID:** 2033

### Abbreviated ASCII Syntax:

```
REFERENCESTATIONTIMEOUT option [timeout]
```

### Factory Default:

```
REFERENCESTATIONTIMEOUT AUTO
```

### ASCII Example:

```
REFERENCESTATIONTIMEOUT SET 90
```

| Field | Field Type                     | ASCII Value | Binary Value | Description   | Format | Binary Bytes | Binary Offset |
|-------|--------------------------------|-------------|--------------|---|--------|--------------|---------------|
| 1     | REFERENCESTATIONTIMEOUT header | -           | -            | Command header. See <i>Messages</i> on page 25 for more information.                                    | -      | H            | 0             |
| 2     | option                         | AUTO        | 1            | Sets the Timeout to 90 seconds <sup>1</sup><br>The Timeout field is optional for AUTO and has no effect | Enum   | 4            | H             |
|       |                                | SET         | 2            | Must set the timeout value using the Timeout field<br>0 is not accepted when using the SET option       |        |              |               |
| 3     | timeout                        | 1 to 3600 s |              | Specify the time  | Ulong  | 4            | H+4           |

<sup>1</sup>This behavior is subject to change.

## 2.112 RESET

### *Performs a hardware reset*

**Platform:** OEM719, OEM729, OEM7500, OEM7700, OEM7720, PwrPak7, HxGN PIM7500

This command performs a software reset. The receiver configuration reverts either to the factory default, if no user configuration was saved or the last **SAVECONFIG** settings. Refer to the **FRESET** command on page 170 and **SAVECONFIG** command on page 311.

The optional delay field is used to set the number of seconds the receiver is to wait before resetting.

**Message ID: 18**

#### Abbreviated ASCII Syntax:

```
RESET [delay]
```

#### Input Example

```
RESET 30
```



The **RESET** command can be used to erase any unsaved changes to the receiver configuration.

Unlike the **FRESET** command on page 170, the **RESET** command does not erase data stored in the NVM, such as Almanac and Ephemeris data.

| Field | Field Type   | ASCII Value | Binary Value | Description  | Format | Binary Bytes | Binary Offset |
|-------|--------------|-------------|--------------|--|--------|--------------|---------------|
| 1     | RESET header | -           | -            | Command header. See <i>Messages</i> on page 25 for more information. | -      | H            | 0             |
| 2     | delay (0-60) |             |              | Seconds to wait before resetting (default = 0)                       | Ulong  | 4            | H             |

## 2.113 RFINPUTGAIN

### *Configure the Calibrated Antenna Gain (CAG)*

**Platform: OEM719, OEM729, OEM7500, OEM7700, OEM7720, PwrPak7, HxGN PIM7500**

Use this command to select the mode (AUTO or MANUAL) of setting the CAG for the purpose of interference detection.

If auto mode is used, the receiver will automatically compute the CAG at start up. In this case it is assumed that the receiver is powered up with its antenna connected and no interference is present.



If the antenna is changed, either reset the receiver or reissue this command to allow receiver to re-compute the CAG.

If manual mode is used, the CAG input by the user is used by the receiver to detect interference.

The CAG is defined to be the cascaded RF gain before receiver input plus LNA noise figure (NF), counting active antenna LNA gain, in-line amplifier, RF cable or distribution loss prior to receiver input connector.

A typical GNSS active antenna (of reasonable quality) has a noise figure of ~2dB (dominated by the LNA in an active antenna).

$RFINPUTGAIN = \text{Cascaded Gain before receiver} + \text{LNA NF}$



**For advanced users.**

If using this command in manual mode, the antenna gain must be accurately measured. If an erroneous CAG is injected, the interference detection performance can be degraded.

**Message ID: 2155**

**Abbreviated ASCII Syntax:**

```
RFINPUTGAIN rf_path [mode] [CAG]
```

**Factory Default:**

```
RFINPUTGAIN L1 AUTO
```

```
RFINPUTGAIN L2 AUTO
```

```
RFINPUTGAIN L5 AUTO
```

**ASCII Example:**

```
RFINPUTGAIN L1 MANUAL 30
```

```
RFINPUTGAIN L2 30
```



| Field | Field Type         | ASCII Value | Binary Value | Description  | Format | Binary Bytes | Binary Offset |
|-------|--------------------|-------------|--------------|--|--------|--------------|---------------|
| 1     | RFINPUTGAIN header | -           | -            | Command header. See <i>Messages</i> on page 25 for more information. | -      | H            | 0             |
| 2     | rf_path            | L1          | 2            | RF path selection  | Enum   | 4            | H             |
|       |                    | L2          | 3            |  |        |              |               |
|       |                    | L5          | 5            |  |        |              |               |
| 3     | mode               | AUTO        | 0            | Calibrated Antenna Gain (CAG) mode.                                  | Enum   | 4            | H+4           |
|       |                    | MANUAL      | 1            | Default = MANUAL   |        |              |               |
| 4     | CAG                | 0.0-100.0   |              | Calibrated Antenna Gain value  | Float  | 4            | H+8           |

## 2.114 RTKANTENNA

***Specifies L1 phase center (PC) or ARP and enables/disables PC modeling***

**Platform: OEM719, OEM729, OEM7500, OEM7700, OEM7720, PwrPak7, HxGN PIM7500**

Use this command to specify whether to use L1 phase center or Antenna Reference Point (ARP) positioning.

There is also an option to apply phase center variation modeling. If there are any conditions that make a selected mode impossible, the solution status in the position log will indicate an error or warning.

L1 ARP offsets and L2 ARP offsets can be entered using the **BASEANTENNAPCO** command on page 79 and **THISANTENNAPCO** command on page 359. Phase center variation parameters can be entered using the **BASEANTENNAPCV** command on page 81 and **THISANTENNAPCV** command on page 360.

Error states occur if either the rover does not have the necessary antenna information entered or the base is not sending sufficient information to work in the requested mode. An example of these error conditions is:

- Position reference to the ARP is requested but no rover antenna model is available

**Message ID: 858**

**Abbreviated ASCII Syntax:**

```
RTKANTENNA posref pcv
```

**Factory Default:**

```
RTKANTENNA unknown disable
```

**ASCII Example:**

```
RTKANTENNA arp enable
```



This command is used for high precision RTK positioning allowing application of antenna offset and phase center variation parameters.

| Field | Field Type        | ASCII Value | Binary Value | Description  | Format | Binary Bytes | Binary Offset |
|-------|-------------------|-------------|--------------|--|--------|--------------|---------------|
| 1     | RTKANTENNA header | -           | -            | Command header. See <i>Messages</i> on page 25 for more information. | -      | H            | 0             |

| Field | Field Type | ASCII Value | Binary Value | Description                        | Format | Binary Bytes | Binary Offset |
|-------|------------|-------------|--------------|------------------------------------|--------|--------------|---------------|
| 2     | posref     | L1PC        | 0            | L1 phase center position reference | Enum   | 4            | H             |
|       |            | ARP         | 1            | ARP position reference             |        |              |               |
|       |            | UNKNOWN     | 2            | Unknown position reference         |        |              |               |
| 3     | pcv        | DISABLE     | 0            | Disable PCV modeling               | Enum   | 4            | H+4           |
|       |            | ENABLE      | 1            | Enable PCV modeling                |        |              |               |
| 4     | Reserved   |             |              |                                    | Bool   | 4            | H+8           |
| 5     | Reserved   |             |              |                                    | Bool   | 4            | H+12          |

## 2.115 RTKASSIST

### *Enable or disable RTK ASSIST*

**Platform: OEM719, OEM729, OEM7500, OEM7700, OEM7720, PwrPak7, HxGN PIM7500**

This command enables or disables RTK ASSIST.

RTK ASSIST uses L-Band-delivered corrections to enable RTK operation to continue for extended durations if RTK corrections are lost. In order to use RTK ASSIST, a receiver model with L-Band tracking capability and an RTK ASSIST subscription are needed. Using this subscription, up to 20 minutes of extended RTK operation are possible. Smaller durations can be set using the **RTKASSISTTIMEOUT** command (see page 293).

When active, RTK ASSIST is shown in the RTKPOS and BESTPOS extended solution status field (see *Table 77: Extended Solution Status* on page 423). The active status and further details on the RTK ASSIST status are available through the **RTKASSISTSTATUS** log on page 717.



For reliable RTK ASSIST performance, the RTK base station position must be within 1 metre of its true WGS84 position.

**Message ID: 1985**

**Abbreviated ASCII Syntax:**

RTKASSIST switch

**Factory Default:**

RTKASSIST enable

**ASCII Example:**

RTKASSIST disable

| Field | Field Type       | ASCII Value | Binary Value | Description  | Format | Binary Bytes | Binary Offset |
|-------|------------------|-------------|--------------|--|--------|--------------|---------------|
| 1     | RTKASSIST header | -           | -            | Command header. See <i>Messages</i> on page 25 for more information. | -      | H            | 0             |
| 2     | switch           | DISABLE     | 0            | Disable RTK ASSIST   | Enum   | 4            | H             |
|       |                  | ENABLE      | 1            | Enable RTK ASSIST  |        |              |               |

## 2.116 RTKASSISTTIMEOUT

### *Set the maximum RTK ASSIST duration*

**Platform:** OEM719, OEM729, OEM7500, OEM7700, OEM7720, PwrPak7, HxGN PIM7500

This command sets how long the receiver will report an RTK solution when RTK is being maintained by RTK ASSIST. The maximum permitted duration of RTK ASSIST operation is determined by the subscription and receiver model. Values less than the subscription limit can be set using the **RTKASSISTTIMEOUT** command.



When RTK ASSIST is active, the **RTKTIMEOUT** command is disregarded. The maximum time that RTK will continue past an RTK corrections outage is controlled by **RTKASSISTTIMEOUT**.

**Message ID:** 2003

#### **Abbreviated ASCII Syntax:**

```
RTKASSISTTIMEOUT limit_type [limit_value]
```

#### **Factory Default:**

```
RTKASSISTTIMEOUT SUBSCRIPTION_LIMIT
```

#### **ASCII Example:**

```
RTKASSISTTIMEOUT USER_LIMIT 900
```

| Field | Field Type              | ASCII Value        | Binary Value | Description   | Format | Binary Bytes | Binary Offset |
|-------|-------------------------|--------------------|--------------|---|--------|--------------|---------------|
| 1     | RTKASSISTTIMEOUT header | -                  | -            | Command header. See <i>Messages</i> on page 25 for more information.                                  | -      | H            | 0             |
| 2     | limit_type              | SUBSCRIPTION_LIMIT | 0            | Use maximum permitted duration limit.   | Enum   | 4            | H             |
|       |                         | USER_LIMIT         | 1            | The maximum RTK ASSIST duration is user set, up to the limit permitted by the subscription and model. |        |              |               |

---

| Field | Field Type  | ASCII Value | Binary Value | Description   | Format | Binary Bytes | Binary Offset |
|-------|-------------|-------------|--------------|---|--------|--------------|---------------|
| 3     | limit_value |             |              | Time out value in seconds.<br>Only valid for the USER_LIMIT Limit Type. | Ulong  | 4            | H+4           |

## 2.117 RTKDYNAMICS

### *Sets the RTK dynamics mode*

**Platform: OEM719, OEM729, OEM7500, OEM7700, OEM7720, PwrPak7, HxGN PIM7500**

This command is used to specify how the receiver looks at the data. There are three modes: STATIC, DYNAMIC and AUTO. The STATIC mode forces the RTK software to treat the rover station as though it were stationary.

DYNAMIC mode forces the software to treat the rover as though it were in motion. If the receiver is undergoing very slow, steady motion (<2.5 cm/s for more than 5 seconds), use DYNAMIC mode (as opposed to AUTO) to prevent inaccurate results and possible resets.



For reliable performance, the antenna should not move more than 1-2 cm when in STATIC mode.

**Message ID: 183**

#### Abbreviated ASCII Syntax:

```
RTKDYNAMICS mode
```

#### Factory Default:

```
RTKDYNAMICS dynamic
```

#### ASCII Example:

```
RTKDYNAMICS static
```



Use the STATIC option to decrease the time required to fix ambiguities and reduce the amount of noise in the position solution. If STATIC mode is used when the antenna is not static, the receiver will have erroneous solutions and unnecessary RTK resets.

| Field | Field Type         | ASCII Value | Binary Value | Description  | Format | Binary Bytes | Binary Offset |
|-------|--------------------|-------------|--------------|--|--------|--------------|---------------|
| 1     | RTKDYNAMICS header | -           | -            | Command header. See <i>Messages</i> on page 25 for more information. | -      | H            | 0             |
| 2     | mode               | AUTO        | 0            | Automatically determines dynamics mode                               | Enum   | 4            | H             |
|       |                    | STATIC      | 1            | Static mode  |        |              |               |
|       |                    | DYNAMIC     | 2            | Dynamic mode   |        |              |               |

## 2.118 RTKINTEGERCRITERIA

### *Report inaccurate fixed-integer RTK positions with float solution type*

**Platform: OEM719, OEM729, OEM7500, OEM7700, OEM7720, PwrPak7, HxGN PIM7500**

This command forces a fixed-integer RTK position to be reported as float if the estimated solution standard deviation exceeds a threshold.

Normally, a fixed-integer solution is very accurate. However, in some rarely-occurring situations, even a fixed-integer solution can become inaccurate; for example, if the DOP is high due to satellites not being visible. In such cases, the accuracy of the RTK solution might be worse than what is customarily expected from a fixed-integer solution. The **RTKINTEGERCRITERIA** command changes the solution type of these high standard deviation integer solutions to their float equivalent. `NARROW_INT`, for instance, becomes `NARROW_FLOAT`. Depending on the `GGAQUALITY` command setting, this will also impact the NMEA GGA quality flag.

**Message ID: 2070**

#### Abbreviated ASCII Syntax:

```
RTKINTEGERCRITERIA criteria threshold
```

#### Factory Default:

```
RTKINTEGERCRITERIA TOTAL_STDDEV 1.0
```

#### ASCII Example:

```
RTKINTEGERCRITERIA HORIZONTAL_STDDEV 0.25
```

| Field | Field Type                 | ASCII Value       | Binary Value | Description  | Format | Binary Bytes | Binary Offset |
|-------|----------------------------|-------------------|--------------|--|--------|--------------|---------------|
| 1     | RTKINTEGER CRITERIA header | -                 | -            | Command header. See <i>Messages</i> on page 25 for more information.   | -      | H            | 0             |
| 2     | criteria                   | TOTAL_STDDEV      | 1            | Test the threshold against the estimated total, 3D, standard deviation | Enum   | 4            | H             |
|       |                            | HORIZONTAL_STDDEV | 2            | Test the threshold against the estimated horizontal standard deviation |        |              |               |



---

| Field | Field Type | ASCII Value       | Binary Value | Description   | Format | Binary Bytes | Binary Offset |
|-------|------------|-------------------|--------------|---|--------|--------------|---------------|
| 3     | threshold  | 0.01 m and higher |              | Estimated solution standard deviation (m) required for solution to be reported as integer | Float  | 4            | H+4           |

## 2.119 RTKMATCHEDTIMEOUT

**Sets RTK filter reset time after corrections are lost**

**Platform:** OEM719, OEM729, OEM7500, OEM7700, OEM7720, PwrPak7, HxGN PIM7500

This command sets the length of time the receiver continues to use the last RTK correction data once the corrections stop. Once this time is reached, the RTK filter is reset.

**Message ID:** 1447

**Abbreviated ASCII Syntax:**

```
RTKMATCHEDTIMEOUT timeout
```

**ASCII Example:**

```
RTKMATCHEDTIMEOUT 180
```

**Factory Default**

```
RTKMATCHEDTIMEOUT 300
```

| Field | Field Type               | ASCII Value | Binary Value | Description  | Format | Binary Bytes | Binary Offset |
|-------|--------------------------|-------------|--------------|--|--------|--------------|---------------|
| 1     | RTKMATCHEDTIMEOUT header | -           | -            | Command header. See <i>Messages</i> on page 25 for more information. | -      | H            | 0             |
| 2     | timeout                  | 1 to 3600 s |              | Time out period  | Ulong  | 4            | H             |

## 2.120 RTKNETWORK

### *Specifies the RTK network mode*

**Platform: OEM719, OEM729, OEM7500, OEM7700, OEM7720, PwrPak7, HxGN PIM7500**

Network RTK uses permanent base station installations, allowing kinematic GNSS users to achieve centimetre accuracies, without the need of setting up a GNSS base station, at a known site. This command sets the RTK network mode for a specific network. For more details on Network RTK, refer to the application note [APN-041 Network RTK](#), available on our website at [www.novatel.com/support/search](http://www.novatel.com/support/search).

**Message ID: 951**

#### **Abbreviated ASCII Syntax:**

```
RTKNETWORK mode [network#]
```

#### **Factory Default:**

```
RTKNETWORK AUTO
```

#### **Input Example:**

```
RTKNETWORK imax
```

| Field | Field Type        | ASCII Value  | Binary Value | Description   | Format | Binary Bytes | Binary Offset |
|-------|-------------------|--|--------------|---|--------|--------------|---------------|
| 1     | RTKNETWORK header | -  | -            | Command header. See <i>Messages</i> on page 25 for more information.  | -      | H            | 0             |
| 2     | mode              | <i>Table 55: Network RTK Mode</i> on the next page |              | RTK network mode. The factory default is auto where the receiver switches to the first available network RTK source | Enum   | 4            | H             |
| 3     | network#          | 0 to 4294967295                                    |              | Specify a number for the network (default = 0)  | Ulong  | 4            | H+4           |

**Table 55: Network RTK Mode**

| Binary | ASCII    | Description   |
|--------|----------|---|
| 0      | DISABLE  | Single reference station RTK mode. All received network RTK corrections are ignored.  |
| 1-4    | Reserved |   |
| 5      | VRS      | <p>The Virtual Reference Station (VRS) or Virtual Base Station (VBS) idea introduced by Trimble, is that a base station is artificially created in the vicinity of a rover receiver. All baseline length dependent errors, such as abnormal troposphere variation, ionospheric disturbances and orbital errors, are reduced for this VRS. The rover receiving VRS information has a lower level of these errors than a distant base station. The VRS is calculated for a position, supplied by the rover during communication start up, with networking software. The VRS position can change if the rover is far away from the initial point. The format for sending the rover's position is standard NMEA format. Most rovers receive VRS data, for a calculated base station, within a couple of metres away.</p> <p>The VRS approach requires bi-directional communication for supplying the rover's position to the networking software.</p>   |
| 6      | IMAX     | <p>The iMAX idea, introduced by Leica Geosystems, is that networking software corrections, based on the rover's position, are calculated as with VRS. However, instead of calculating the base station observations for the provided position or another position closer to the base station, original observation information is corrected with the calculated corrections and broadcast. VRS works so that although the rover is unaware of the errors the VRS is taking care of, there still might be ionospheric remains in the base station observations. iMAX provides actual base station position information. The rover may assume the base station is at a distance and open its settings for estimation of the remaining ionospheric residuals. The iMAX method may trigger the rover to open its settings further than required, since the networking software removes at least part of the ionospheric disturbances. However, compared to VRS above, this approach is safer since it notifies the rover when there might be baseline length dependent errors in the observation information. iMAX requires bi-directional communication to the networking software for supplying the base station observation information.</p> |
| 7      | FKP      | <p>The FKP method delivers the information from a base station network to the rover. No precise knowledge of the rover's position is required for providing the correct information. The corrections are deployed as gradients to be used for interpolating to the rover's actual position.</p>   |

| Binary | ASCII    | Description   |
|--------|----------|---|
| 8      | MAX      | The basic principle of the master-auxiliary concept is to provide, in compact form, as much of the information from the network and the errors it is observing to the rover as possible. With more information about the state and distribution of the dispersive and non-dispersive errors across the network, the rover is able to use more intelligent algorithms in the determination of its position solution. Each supplier of reference station software will have their own proprietary algorithms for modeling or estimating these error sources. The rover system can decide to use or to neglect the network RTK information, depending on its own firmware algorithm performance. |
| 9      | Reserved |   |
| 10     | AUTO     | Default value, assume single base. If network RTK corrections are detected then the receiver will switch to the appropriate mode. iMAX and VRS can only be detected using RTCMV3, however, it is not possible to distinguish between iMAX or VRS. If iMAX or VRS is detected, then iMAX will be assumed.  |

## 2.121 RTKPORTMODE

*Assigns the port for RTK and ALIGN messages*

**Platform: OEM719, OEM729, OEM7500, OEM7700, OEM7720, PwrPak7, HxGN PIM7500**



This command only applies to receivers with both RTK and ALIGN enabled.

A rover receiver with RTK and ALIGN enabled can receive RTK and ALIGN corrections at the same time. However, the two different sources (RTK and ALIGN) must be sent to different ports. Use the RTKPORTMODE command to route correction feeds to different ports. RTK and ALIGN can be routed to any user specified ports.

Failing to specify the mode for the incoming source could cause unexpected behavior of RTK or ALIGN.



Ports configured using the RTKPORTMODE command must also be configured using the **INTERFACEMODE** command (see page 189).

**Message ID: 1936**

**Abbreviated ASCII Syntax:**

```
RTKPORTMODE [port] mode
```

**Factory Default:**

```
RTKPORTMODE COM1 RTK
RTKPORTMODE COM2 RTK
RTKPORTMODE COM3 RTK
RTKPORTMODE COM4 RTK
RTKPORTMODE COM5 RTK
RTKPORTMODE COM6 RTK
RTKPORTMODE XCOM1 RTK
RTKPORTMODE XCOM2 RTK
RTKPORTMODE XCOM3 RTK
RTKPORTMODE ICOM1 RTK
RTKPORTMODE ICOM2 RTK
RTKPORTMODE ICOM3 RTK
RTKPORTMODE ICOM4 RTK
RTKPORTMODE ICOM5 RTK
RTKPORTMODE ICOM6 RTK
RTKPORTMODE ICOM7 RTK
```

```

RTKPORTMODE NCOM1 RTK
RTKPORTMODE NCOM2 RTK
RTKPORTMODE NCOM3 RTK
RTKPORTMODE USB1 RTK
RTKPORTMODE USB2 RTK
RTKPORTMODE USB3 RTK
RTKPORTMODE WCOM1 RTK
RTKPORTMODE BT1 RTK
RTKPORTMODE AUX RTK
RTKPORTMODE CCOM1 RTK
RTKPORTMODE CCOM2 RTK
RTKPORTMODE CCOM3 RTK
RTKPORTMODE CCOM4 RTK
RTKPORTMODE CCOM5 ALIGN
RTKPORTMODE CCOM6 RTK
    
```

**ASCII Example:**

```

RTKPORTMODE COM2 RTK
RTKPORTMODE COM3 ALIGN
    
```

| Field | Field Type     | ASCII Value  | Binary Value | Description  | Format | Binary Bytes | Binary Offset |
|-------|----------------|--|--------------|--|--------|--------------|---------------|
| 1     | COMMAND header | -  | -            | Command header. See <i>Messages</i> on page 25 for more information. | -      | H            | 0             |
| 2     | Port           | See <i>Table 31: Communications Port Identifiers</i> on page 130 |              | Port identifier (default = THISPORT)                                 | Enum   | 4            | H             |
| 3     | Mode           | RTK  | 0            | Mode for this port   | Enum   | 4            | H+4           |
|       |                | ALIGN  | 1            |  |        |              |               |

## 2.122 RTKQUALITYLEVEL

### *Sets an RTK quality mode*

**Platform:** OEM719, OEM729, OEM7500, OEM7700, OEM7720, PwrPak7, HxGN PIM7500

Use this command to select an RTK quality mode.

**Message ID:** 844

**Abbreviated ASCII Syntax:**

```
RTKQUALITYLEVEL mode
```

**Factory Default:**

```
RTKQUALITYLEVEL normal
```

**ASCII Example:**

```
RTKQUALITYLEVEL extra_safe
```



The **EXTRA\_SAFE** mode is needed in areas where the signal is partially blocked and the position solution in NORMAL mode shows NARROW\_INT even though the real position solution is out by several metres. Using EXTRA\_SAFE in these environments means the solution will be slower getting to NARROW\_INT but it is less likely to be erroneous.

| Field | Field Type              | ASCII Value | Binary Value | Description  | Format | Binary Bytes | Binary Offset |
|-------|-------------------------|-------------|--------------|--|--------|--------------|---------------|
| 1     | RTKQUALITY-LEVEL header | -           | -            | Command header. See <i>Messages</i> on page 25 for more information. | -      | H            | 0             |
| 2     | mode                    | NORMAL      | 1            | Set the RTK quality level mode to Normal RTK                         | Enum   | 4            | H             |
|       |                         | EXTRA_SAFE  | 4            | Set the RTK quality level mode to Extra Safe RTK                     |        |              |               |



## 2.123 RTKRESET

### *Reset the RTK filter*

**Platform:** OEM719, OEM729, OEM7500, OEM7700, OEM7720, PwrPak7, HxGN PIM7500

This command resets the RTK filter and causes the AdVanceRTK filter to undergo a complete reset, forcing the system to restart the ambiguity resolution calculations.

**Message ID:** 2082

**Abbreviated ASCII Syntax:**

```
RTKRESET [Switch]
```

**Example :**

```
RTKRESET
```

| Field | Field Type      | ASCII Value | Binary Value | Description  | Format | Binary Byte | Binary Offset |
|-------|-----------------|-------------|--------------|--|--------|-------------|---------------|
| 1     | RTKRESET header | -           | -            | Command header. See <i>Messages</i> on page 25 for more information. | -      | H           | 0             |
| 2     | Switch          | FILTER      | 1            | Reset the RTK filter.<br>This is an optional parameter               | Enum   | 4           | H             |

## 2.124 RTKSOURCE

### *Sets the RTK correction source*

**Platform: OEM719, OEM729, OEM7500, OEM7700, OEM7720, PwrPak7, HxGN PIM7500**

This command is used to identify from which base station to accept RTK (RTCMV3) differential corrections. This is useful when the receiver is receiving corrections from multiple base stations. See also the **PSRDIFFSOURCE** command on page 275.

**Message ID: 494**

#### **Abbreviated ASCII Syntax:**

```
RTKSOURCE type [id]
```

#### **Factory Default:**

```
RTKSOURCE auto ANY
```

#### **ASCII Examples:**

1. Specify the format before specifying the base station IDs:

```
RTKSOURCE RTCM3 5
RTKSOURCE RTCMV3 6
```

2. Select only SBAS:

```
RTKSOURCE NONE
PSRDIFFSOURCE SBAS
SBASCONTROL ENABLE AUTO
```

3. Enable RTK and PSRDIFF from RTCM, with a fall-back to SBAS:

```
RTKSOURCE RTCMV3 ANY
PSRDIFFSOURCE RTCMV3 ANY
SBASCONTROL ENABLE AUTO
```



Consider an agricultural example where a farmer has their own RTCM base station set up but due to either obstructions or radio problems, occasionally experiences loss of corrections. By specifying a fall back to SBAS, the farmer could set up their receiver to use transmitted RTCM corrections when available but fall back to SBAS.

| Field | Field Type       | ASCII Value | Binary Value | Description  | Format | Binary Bytes | Binary Offset |
|-------|------------------|-------------|--------------|--|--------|--------------|---------------|
| 1     | RTKSOURCE header | -           | -            | Command header. See <i>Messages</i> on page 25 for more information. | -      | H            | 0             |

---

| Field | Field Type      | ASCII Value                                | Binary Value | Description          | Format  | Binary Bytes   | Binary Offset |
|-------|-----------------|--|--------------|----------------------|---------|----------------|---------------|
| 2     | type            | See <i>Table 52: DGPS Type</i> on page 276 |              | ID Type <sup>1</sup> | Enum    | 4              | H             |
| 3     | Base station ID | Char [4] or ANY                            |              | ID string            | Char[5] | 8 <sup>2</sup> | H+4           |

---

<sup>1</sup>If ANY chosen, the receiver ignores the ID string. Specify a type when using base station IDs.

<sup>2</sup>In the binary log case, an additional 3 bytes of padding are added to maintain 4-byte alignment.

## 2.125 RTKSOURCETIMEOUT

### *Sets RTK correction source timeout*

**Platform:** OEM719, OEM729, OEM7500, OEM7700, OEM7720, PwrPak7, HxGN PIM7500

When multiple RTK correction sources are available, this command allows the user to set a time, in seconds, that the receiver will wait before switching to another RTK correction source if corrections from the original source are lost.

**Message ID:** 1445

#### Abbreviated ASCII Syntax:

```
RTKSOURCETIMEOUT option [timeout]
```

#### Factory Default:

```
RTKSOURCETIMEOUT AUTO
```

#### ASCII Example:

```
RTKSOURCETIMEOUT auto
```

```
RTKSOURCETIMEOUT set 180
```

| Field | Field Type                     | ASCII Value              | Binary Value | Description  | Format | Binary Bytes | Binary Offset |
|-------|--------------------------------|--------------------------|--------------|--|--------|--------------|---------------|
| 1     | RTKSOURCE<br>TIMEOUT<br>header | -                        | -            | Command header. See <i>Messages</i> on page 25 for more information.   | -      | H            | 0             |
| 2     | option                         | AUTO                     | 1            | Sets the timeout according to network type or other self-detected conditions. Timeout field is optional for AUTO and has no effect | Enum   | 4            | H             |
|       |                                | SET                      | 2            | Sets the timeout to the value entered in the <i>timeout</i> field.   |        |              |               |
| 3     | timeout                        | 1 to 3600 s<br>(maximum) |              | Specify the time<br>0 is not accepted if <i>SET</i> is entered in the <i>option</i> field<br>(default=0 for the AUTO option)       | Ulong  | 4            | H+4           |

## 2.126 RTKSVENTRIES

### *Sets number of satellites in corrections*

**Platform: OEM719, OEM729, OEM7500, OEM7700, OEM7720, PwrPak7, HxGN PIM7500**

This command sets the number of satellites (at the highest elevation) that are transmitted in the RTK corrections from a base station receiver. This is useful when the amount of bandwidth available for transmitting corrections is limited.

**Message ID: 92**

#### **Abbreviated ASCII Syntax:**

```
RTKSVENTRIES number
```

#### **Factory Default:**

```
RTKSVENTRIES 24
```

#### **ASCII Example:**

```
RTKSVENTRIES 7
```



GPS devices have enabled many transit and fleet authorities to provide Automatic Vehicle Location (AVL). AVL systems track the position of individual vehicles and relay that data back to a remote dispatch location that can store or better utilize the information. Consider the implementation of an AVL system within a police department, to automatically log and keep track of the location of each cruiser. Typically a fleet uses a 9600 bps connection where AVL data is relayed back to headquarters. The limited bandwidth of the radio must be shared amongst the AVL and other systems in multiple cruisers.

When operating with a low baud rate radio transmitter (9600 or lower), especially over a long distance, the AVL system could limit the number of satellites for which corrections are sent using the **RTKSVENTRIES** command.

| Field | Field Type          | ASCII Value | Binary Value | Description  | Format | Binary Bytes | Binary Offset |
|-------|---------------------|-------------|--------------|--|--------|--------------|---------------|
| 1     | RTKSVENTRIES header | -           | -            | Command header. See <i>Messages</i> on page 25 for more information. | -      | H            | 0             |
| 2     | number              | 4-24        |              | The number of SVs to be transmitted in correction messages           | Ulong  | 4            | H             |

## 2.127 RTKTIMEOUT

### *Sets maximum age of RTK data*

**Platform: OEM719, OEM729, OEM7500, OEM7700, OEM7720, PwrPak7, HxGN PIM7500**

This command is used to set the maximum age of RTK data to use when operating as a rover station. RTK data received that is older than the specified time is ignored.



When RTK ASSIST is active, the **RTKTIMEOUT** command is disregarded. The maximum time that RTK will continue past an RTK corrections outage is controlled by the settings in the **RTKASSISTTIMEOUT** command (see page 293).

**Message ID: 910**

**Abbreviated ASCII Syntax:**

```
RTKTIMEOUT delay
```

**Factory Default:**

```
RTKTIMEOUT 60
```

**ASCII Example (rover):**

```
RTKTIMEOUT 20
```

| Field | Field Type        | ASCII Value | Binary Value | Description  | Format | Binary Bytes | Binary Offset |
|-------|-------------------|-------------|--------------|--|--------|--------------|---------------|
| 1     | RTKTIMEOUT header | -           | -            | Command header. See <i>Messages</i> on page 25 for more information. | -      | H            | 0             |
| 2     | delay             | 5 to 60 s   |              | Maximum RTK data age   | Ulong  | 4            | H             |

## 2.128 SAVECONFIG

### *Save current configuration in NVM*

**Platform:** OEM719, OEM729, OEM7500, OEM7700, OEM7720, PwrPak7, HxGN PIM7500

This command saves the present configuration in Non-Volatile Memory (NVM). The configuration includes the current log settings, FIX settings, port configurations and so on. The output is in the **RXCONFIG** log (see page 732). See also the **FRESET** command on page 170.



If using the **SAVECONFIG** command in NovAtel Connect, ensure that you have all windows other than the Console window closed. Otherwise, log requests used for the various windows are saved as well. This will result in unnecessary data being logged.

**Message ID:** 19

**Abbreviated ASCII Syntax:**

SAVECONFIG

| Field | Field Type        | ASCII Value | Binary Value | Description  | Format | Binary Bytes | Binary Offset |
|-------|-------------------|-------------|--------------|--|--------|--------------|---------------|
| 1     | SAVECONFIG header | -           | -            | Command header. See <i>Messages</i> on page 25 for more information. | -      | H            | 0             |

## 2.129 SAVEETHERNETDATA

*Save the configuration data associated with an Ethernet interface*

**Platform:** OEM729, OEM7700, OEM7720, PwrPak7

Saving the configuration data for an Ethernet interface allows the interface to start automatically at boot time and be configured with either a static IP address or to obtain an address using DHCP. The **SAVEETHERNETDATA** command saves the configuration for the interface previously entered using the **ETHCONFIG** command (see page 137), **IPCONFIG** command (see page 196) and **DNSCONFIG** command (see page 126). The configuration data that is saved will survive a **RESET** command (see page 287) and **FRESET** command (see page 170). To clear the Ethernet interface configuration data, the **FRESET ETHERNET** command is used. It is not necessary to issue the **SAVECONFIG** command (see page 311) to save the Ethernet interface configuration data. In fact, if **SAVECONFIG** is used to save the **ETHCONFIG**, **IPCONFIG** and **DNSCONFIG** commands, the configuration saved by **SAVEETHERNETDATA** will take precedence over the **SAVECONFIG** configuration.

**Message ID:** 1679

**Abbreviated ASCII Syntax:**

```
SAVEETHERNETDATA [Interface]
```

**ASCII Example:**

```
ETHCONFIG ETHA AUTO AUTO AUTO AUTO
IPCONFIG ETHA STATIC 192.168.8.11 255.255.255.0 192.168.8.1
DNSCONFIG 1 192.168.4.200
SAVEETHERNETDATA ETHA
```

| Field | Field Type               | ASCII Value | Binary Value | Description   | Format | Binary Bytes | Binary Offset |
|-------|--------------------------|-------------|--------------|---|--------|--------------|---------------|
| 1     | SAVEETHERNET DATA header | -           | -            | Command header. See <i>Messages</i> on page 25 for more information.            | -      | H            | 0             |
| 2     | Interface                | ETHA        | 2            | The Ethernet interface to save the configuration data for. The default is ETHA. | Enum   | 4            | H             |

Note that the configurations set using the **ICOMCONFIG** command (see page 187) and **NTRIPCONFIG** command (see page 244) are not saved by the **SAVEETHERDATA** command. The following factory default ICOM configurations can be used if Ethernet access to the receiver is required immediately after the receiver is **RESET** or **FRESET**.

```
ICOMCONFIG ICOM1 TCP :3001
ICOMCONFIG ICOM2 TCP :3002
ICOMCONFIG ICOM3 TCP :3003
ICOMCONFIG ICOM4 TCP :3004
ICOMCONFIG ICOM5 TCP :3005
```



```
ICOMCONFIG ICOM6 TCP :3006
```

```
ICOMCONFIG ICOM7 TCP :3007
```

See also the following commands:

- **ETHCONFIG** command on page 137
- **IPCONFIG** command on page 196
- **DNSCONFIG** command on page 126
- **FRESET** command on page 170

## 2.130 SBASCONTROL

### *Sets SBAS test mode and PRN*

**Platform: OEM719, OEM729, OEM7500, OEM7700, OEM7720, PwrPak7, HxGN PIM7500**

This command is used to dictate how the receiver tracks and uses correction data from Satellite Based Augmentation Systems (SBAS).

To enable the position solution corrections, issue the **SBASCONTROL ENABLE** command. The receiver does not, by default, attempt to track or use any SBAS signals satellites unless told to do so by the **SBASCONTROL** command. When in AUTO mode, if the receiver is outside the defined satellite system's corrections grid, it reverts to ANY mode and chooses a system based on other criteria.

The "testmode" parameter in the example provides a method to use a particular satellite even if it is currently operating in test mode. The recommended setting for tracking satellites operating in test mode is ZEROTOTWO. On a simulator, you may want to leave this parameter off or specify NONE explicitly.

When using the **SBASCONTROL** command to direct the receiver to use a specific correction type, the receiver begins to search for and track the relevant GEO PRNs for that correction type only.

The receiver can be forced to track a specific PRN using the **ASSIGN** command (see page 66). The receiver can also be forced to use the corrections from a specific SBAS PRN using the **SBASCONTROL** command.

Disable stops the corrections from being used.

**Message ID: 652**

#### **Abbreviated ASCII Syntax:**

```
SBASCONTROL switch [system] [prn] [testmode]
```

#### **Factory Default:**

```
SBASCONTROL disable
```

#### **ASCII Example:**

```
SBASCONTROL enable waas
```

| Field | Field Type         | ASCII Value | Binary Value | Description  | Format | Binary Bytes | Binary Offset |
|-------|--------------------|-------------|--------------|--|--------|--------------|---------------|
| 1     | SBASCONTROL header | -           | -            | Command header. See <i>Messages</i> on page 25 for more information. | -      | H            | 0             |

| Field | Field Type | ASCII Value                             | Binary Value | Description  | Format | Binary Bytes | Binary Offset |
|-------|------------|---|--------------|--|--------|--------------|---------------|
| 2     | switch     | DISABLE                                 | 0            | Receiver does not use the SBAS corrections it receives (default)                           | Enum   | 4            | H             |
|       |            | ENABLE                                  | 1            | Receiver uses the SBAS corrections it receives   |        |              |               |
| 3     | system     | See <i>Table 56: System Types</i> below |              | Choose the SBAS the receiver will use  | Enum   | 4            | H+4           |
| 4     | prn        | 0                                       |              | Receiver uses any PRN (default)  | Ulong  | 4            | H+8           |
|       |            | 120-158 and 183-187                     |              | Receiver uses SBAS corrections only from this PRN  |        |              |               |
| 5     | testmode   | NONE                                    | 0            | Receiver interprets Type 0 messages as they are intended (as do not use) (default)         | Enum   | 4            | H+12          |
|       |            | ZEROTOTWO                               | 1            | Receiver interprets Type 0 messages as Type 2 messages                                     |        |              |               |
|       |            | IGNOREZERO                              | 2            | Receiver ignores the usual interpretation of Type 0 messages (as do not use) and continues |        |              |               |

**Table 56: System Types**

| ASCII | Binary | Description   |
|-------|--------|---|
| NONE  | 0      | Does not use any SBAS satellites<br>(Default for SBASCONTROL DISABLE) |

| <b>ASCII</b> | <b>Binary</b> | <b>Description</b>   |
|--------------|---------------|--|
| AUTO         | 1             | Automatically determines satellite system to use and prevents the receiver from using satellites outside of the service area<br>(Default for SBASCONTROL ENABLE) |
| ANY          | 2             | Uses any and all SBAS satellites found   |
| WAAS         | 3             | Uses only WAAS satellites  |
| EGNOS        | 4             | Uses only EGNOS satellites   |
| MSAS         | 5             | Uses only MSAS satellites  |
| GAGAN        | 6             | Uses only GAGAN satellites   |
| QZSS         | 7             | Uses only QZSS SAIF signals  |

## 2.131 SBASECUTOFF

### *Sets SBAS satellite elevation cut-off*

**Platform:** OEM719, OEM729, OEM7500, OEM7700, OEM7720, PwrPak7, HxGN PIM7500

This command sets the elevation cut-off angle for tracked SBAS satellites. The receiver does not start automatically searching for an SBAS satellite until it rises above the cut-off angle (when satellite position is known). Tracked SBAS satellites that fall below the cut-off angle are no longer tracked unless they are manually assigned (see the **ASSIGN** command on page 66).

This command permits a negative cut-off angle and can be used in the following situations:

- The antenna is at a high altitude and can look below the local horizon
- Satellites are visible below the horizon due to atmospheric refraction



Use the **ELEVATIONCUTOFF** command (see page 134) to set the cut-off angle for any system.

**Message ID:** 1000

**Abbreviated ASCII Syntax:**

```
SBASECUTOFF angle
```

**Factory Default:**

```
SBASECUTOFF -5.0
```

**ASCII Example:**

```
SBASECUTOFF 10.0
```

| Field | Field Type         | ASCII Value   | Binary Value | Description  | Format | Binary Bytes | Binary Offset |
|-------|--------------------|---------------|--------------|--|--------|--------------|---------------|
| 1     | SBASECUTOFF header | -             | -            | Command header. See <i>Messages</i> on page 25 for more information. | -      | H            | 0             |
| 2     | angle              | ±90.0 degrees |              | Elevation cut-off angle relative to horizon                          | Float  | 4            | H             |

## 2.132 SBASTIMEOUT

*Sets the SBAS position time out*

**Platform:** OEM719, OEM729, OEM7500, OEM7700, OEM7720, PwrPak7, HxGN PIM7500

This command is used to set the amount of time the receiver remains in an SBAS position if it stops receiving SBAS corrections.

**Message ID:** 1001

**Abbreviated ASCII Syntax:**

```
SBASTIMEOUT mode [delay]
```

**Factory Default:**

```
SBASTIMEOUT auto
```

**ASCII Example:**

```
SBASTIMEOUT set 100
```



When the time out mode is AUTO, the time out delay is 180 s.

| Field | Field Type         | ASCII Value                                   | Binary Value | Description  | Format | Binary Bytes | Binary Offset |
|-------|--------------------|---|--------------|--|--------|--------------|---------------|
| 1     | SBASTIMEOUT header | -   | -            | Command header. See <i>Messages</i> on page 25 for more information. | -      | H            | 0             |
| 2     | mode               | See <i>Table 57: SBAS Time Out Mode</i> below |              | Time out mode  | Enum   | 4            | H             |
| 3     | delay              | 2 to 1000 s                                   |              | Maximum SBAS position age (default=180)                              | Double | 8            | H+4           |
| 4     | Reserved           |   |              |  | Double | 8            | H+12          |

**Table 57: SBAS Time Out Mode**

| Binary | ASCII    | Description                   |
|--------|----------|-------------------------------|
| 0      | Reserved |                               |
| 1      | AUTO     | Set the default value (180 s) |
| 2      | SET      | Set the delay in seconds      |

## 2.133 SELECTCHANCONFIG

### *Sets the channel configuration*

**Platform:** OEM719, OEM729, OEM7500, OEM7700, OEM7720, PwrPak7, HxGN PIM7500

Some software models come with support for more than one channel configuration, which can be verified by logging **CHANCONFIGLIST** log (see page 440). The **SELECTCHANCONFIG** command is used to pick a different channel configuration. If a different channel configuration is selected via the **SELECTCHANCONFIG** command, the receiver resets and starts up with the new configuration. The Set in Use number in the **CHANCONFIGLIST** log (see page 440) changes as a result.



After a FRESET, the channel configuration is reset to 1.

**Message ID:** 1149

**Abbreviated ASCII Syntax:**

```
SELECTCHANCONFIG chanconfigsetting
```

**Factory Default:**

```
SELECTCHANCONFIG 1
```

**ASCII Example:**

```
SELECTCHANCONFIG 2
```

| Field | Field Type              | ASCII Value   | Binary Value | Description  | Format | Binary Bytes | Binary Offset |
|-------|-------------------------|---|--------------|--|--------|--------------|---------------|
| 1     | SELECTCHANCONFIG header | -   | -            | Command header. See <i>Messages</i> on page 25 for more information. | -      | H            | 0             |
| 2     | chanconfigsetting       | 1 to n<br>where n is the number of channel configurations in the <b>CHANCONFIGLIST</b> log (see page 440) |              | Channel configuration to use   | Ulong  | 4            | H             |



Below is a use case example of the **SELECTCHANCONFIG** command. Abbreviated ASCII commands and logs are used to better illustrate the example.

1. LOG CHANCONFIGLIST to show what the channel configuration options are and which channel configuration set is being used.

```
[COM1]<CHANCONFIGLIST COM1 0 84.0 FINESTEERING 1899
418834.598 02040020 d1c0 136
62
1 4
7
16 GPSL1L2PL5
4 QZSSL1CAL2CL5
4 SBASL1
14 GLOL1L2
16 GALE1E5B
22 BEIDOU1B2
1 LBAND
7
16 GPSL1L2
4 QZSSL1CAL2C
4 SBASL1
14 GLOL1L2
16 GALE1E5B
22 BEIDOU1B2
1 LBAND
7
16 GPSL1L2PL2CL5
4 QZSSL1CAL2CL5
4 SBASL1
14 GLOL1L2PL2C
16 GALE1E5AE5BALTBOC
22 BEIDOU1B2
1 LBAND
7
16 GPSL1L2PL2CL5
4 QZSSL1CAL2CL5
4 SBASL1L5
14 GLOL1L2PL2C
16 GALE1E5AE5BALTBOC
22 BEIDOU1B2B3
1 LBAND
[COM1]
```

2. There are two options given for the model and the first channel configuration set is currently being used.
3. If the user would like to use the third channel configuration set enter, **SELECTCHANCONFIG 3** command.
4. The receiver receives the command and resets. At startup, the third channel configuration set is configured.
5. To verify that setting has changed, enter LOG CHANCONFIGLIST



```
[COM1]<CHANCONFIGLIST COM1 0 81.5 FINESTEERING 1899
419140.313 02040020 d1c0 136
62
3 4
    7
    16 GPSL1L2PL5
    4 QZSSL1CAL2CL5
    4 SBASL1
    14 GLOL1L2
    16 GALE1E5B
    22 BEIDOUB1B2
    1 LBAND
    7
    16 GPSL1L2
    4 QZSSL1CAL2C
    4 SBASL1
    14 GLOL1L2
    16 GALE1E5B
    22 BEIDOUB1B2
    1 LBAND
    7
    16 GPSL1L2PL2CL5
    4 QZSSL1CAL2CL5
    4 SBASL1
    14 GLOL1L2PL2C
    16 GALE1E5AE5BALTBOC
    22 BEIDOUB1B2
    1 LBAND
    7
    16 GPSL1L2PL2CL5
    4 QZSSL1CAL2CL5
    4 SBASL1L5
    14 GLOL1L2PL2C
    16 GALE1E5AE5BALTBOC
    22 BEIDOUB1B2B3
    1 LBAND
[COM1]
```

6. This log shows that the third set is selected. To further verify, enter **LOG TRACKSTAT** to show all the configured channels.

## 2.134 SEND

### *Sends an ASCII message to a COM port*

**Platform:** OEM719, OEM729, OEM7500, OEM7700, OEM7720, PwrPak7, HxGN PIM7500

This command is used to send ASCII printable data from any of the COM or USB ports to a specified communications port. This is a one time command, therefore the data message must be preceded by the **SEND** command and followed by <CR> each time data is sent. If the data string contains delimiters (that is, spaces, commas, tabs and so on), the entire string must be contained within double quotation marks. Carriage return and line feed characters (for example, 0x0D, 0x0A) are appended to the sent ASCII data.

**Message ID:** 177

#### **Abbreviated ASCII Syntax:**

```
SEND [port] data
```

#### **ASCII Example**

```
SEND com1 "log com1 rtcaobs ontime 5"
```



**Scenario:** Assume you are operating receivers as base and rover stations. It could also be assumed that the base station is unattended but operational and you wish to control it from the rover station. From the rover station, you could establish the data link and command the base station receiver to send differential corrections.

**Figure 8: Using the SEND Command**

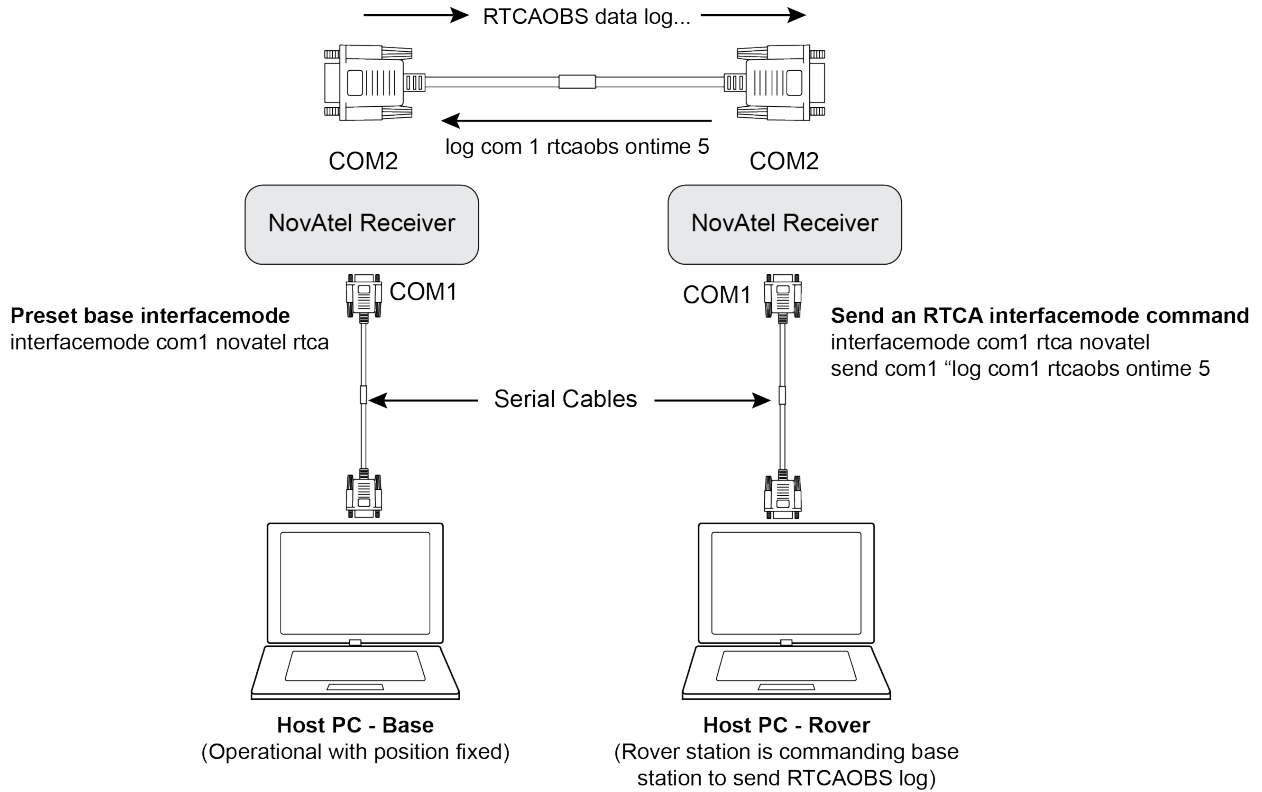

| Field | Field Type  | ASCII Value   | Binary Value | Description  | Format           | Binary Bytes          | Binary Offset |
|-------|-------------|---|--------------|--|------------------|-----------------------|---------------|
| 1     | SEND header | -   | -            | Command header. See <i>Messages</i> on page 25 for more information. | -                | H                     | 0             |
| 2     | port        | See <i>Table 4: Detailed Port Identifier</i> on page 31   |              | Output port (default=THISPORT)                                       | Enum             | 4                     | H             |
| 3     | message     | Max 100 character string (99 typed visible chars and a null char added by the firmware automatically) |              | ASCII data to send   | String [max 100] | Variable <sup>1</sup> | H+4           |

<sup>1</sup>In the binary case, each string field needs to be NULL terminated and additional bytes of padding added to maintain 4-byte alignment, up to the maximum defined by the string size. The next defined field starts immediately at the next 4-byte alignment following the NULL.

## 2.135 SENDHEX

### *Send non-printable characters in hex pairs*

**Platform: OEM719, OEM729, OEM7500, OEM7700, OEM7720, PwrPak7, HxGN PIM7500**

This command is like the **SEND** command (see page 322) except it is used to send non-printable characters expressed as hexadecimal pairs. Carriage return and line feed characters (for example, 0x0D, 0x0A) will not be appended to the sent data and so must be explicitly added to the data if needed.

**Message ID: 178**

#### Abbreviated ASCII Syntax:

```
SENDHEX [port] length data
```

#### Input Example:

```
SENDHEX COM1 6 143Ab5910D0A
```

| Field | Field Type     | ASCII Value  | Binary Value | Description  | Format           | Binary Bytes          | Binary Offset |
|-------|----------------|--|--------------|--|------------------|-----------------------|---------------|
| 1     | SENDHEX header | -  | -            | Command header. See <i>Messages</i> on page 25 for more information. | -                | H                     | 0             |
| 2     | port           | See <i>Table 4: Detailed Port Identifier</i> on page 31  |              | Output port (default=THISPORT)                                       | Enum             | 4                     | H             |
| 3     | length         | 0 - 700  |              | Number of hex pairs  | Ulong            | 4                     | H+4           |
| 4     | message        | limited to a 700 maximum string (1400 pair hex). Even number of ASCII characters from set of 0-9, A-F. No spaces are allowed between pairs of characters |              | Data   | String [max 700] | Variable <sup>a</sup> | H+8           |

<sup>a</sup>In the binary case, each string field needs to be NULL terminated and additional bytes of padding added to maintain 4-byte alignment, up to the maximum defined by the string size. The next defined field starts immediately at the next 4-byte alignment following the NULL.

## 2.136 SERIALCONFIG

### *Configures serial port settings*

**Platform: OEM719, OEM729, OEM7500, OEM7700, OEM7720, PwrPak7, HxGN PIM7500**

This command is used to configure the receiver's asynchronous serial port communications drivers.



1. Also refer to the **ECHO** command on page 129.
2. The **SERIALCONFIG** command can be used as a log to confirm settings.
3. The entire content of the current log is sent before pausing due to the receipt of the XOFF character.

The current SERIALCONFIG port configuration can be reset to its default state by sending it two hardware break signals of 250 milliseconds each, spaced by fifteen hundred milliseconds (1.5 seconds) with a pause of at least 250 milliseconds following the second break. This will:

- Stop the logging of data on the current port (see the **UNLOGALL** command on page 378)
- Clear the transmit and receive buffers on the current port
- Return the current port to its default settings (see *Factory Defaults* on page 53 for details)
- Set the interface mode to NovAtel for both input and output (see the **INTERFACEMODE** command on page 189)

This break detection can be disabled using the **SERIALCONFIG** command.



1. The **COMCONTROL** command (see page 108) may conflict with handshaking of the selected COM port. If handshaking is enabled, then unexpected results may occur.
2. Baud rates higher than 115,200 bps are not supported by standard PC hardware. Special PC hardware may be required for higher rates, including 230400 bps and 460800 bps. Avoid having COM ports of two receivers connected together using baud rates that do not match. Data transmitted through a port operating at a slower baud rate may be misinterpreted as break signals by the receiving port if it is operating at a higher baud rate because data transmitted at the lower baud rate is stretched relative to the higher baud rate. In this case, configure the receiving port to break detection disabled using the **SERIALCONFIG** command.



Use the **SERIALCONFIG** command before using the **INTERFACEMODE** command on each port. Turn break detection off using the **SERIALCONFIG** command to stop the port from resetting because it is interpreting incoming bits as a break command.

**Message ID: 1246**

#### **Abbreviated ASCII Syntax:**

```
SERIALCONFIG [port] baud [parity[databits[stopbits[handshaking[break]]]]]
```

**Factory Defaults:**

```
SERIALCONFIG COM1 9600 N 8 1 N ON
SERIALCONFIG COM2 9600 N 8 1 N ON
SERIALCONFIG COM3 9600 N 8 1 N ON
SERIALCONFIG COM4 9600 N 8 1 N ON
SERIALCONFIG COM5 9600 N 8 1 N ON
```

**ASCII Example:**

```
SERIALCONFIG com1 9600 n 8 1 n off
```

| Field | Field Type             | ASCII Value  | Binary Value | Description  | Format | Binary Bytes | Binary Offset |
|-------|------------------------|--|--------------|--|--------|--------------|---------------|
| 1     | SERIALCONFIG Header    | -  | -            | Command header. See <i>Messages</i> on page 25 for more information. | -      | H            | 0             |
| 2     | port                   | See <i>Table 58: COM Port Identifiers</i> on the next page       |              | Port to configure (default = THISPORT)                               | Enum   | 4            | H             |
| 3     | bps/baud               | 2400, 4800, 9600, 19200, 38400, 57600, 115200, 230400 and 460800 |              | Communication baud rate (bps).                                       | Ulong  | 4            | H+4           |
| 4     | parity                 | See <i>Table 59: Parity</i> on the next page                     |              | Parity   | Enum   | 4            | H+8           |
| 5     | databits               | 7 or 8   |              | Number of data bits (default = 8)                                    | Ulong  | 4            | H+12          |
| 6     | stopbits               | 1 or 2   |              | Number of stop bits (default = 1)                                    | Ulong  | 4            | H+16          |
| 7     | handshake <sup>1</sup> | See <i>Table 60: Handshaking</i> on the next page                |              | Handshaking  | Enum   | 4            | H+20          |
| 8     | break                  | OFF  | 0            | Disable break detection  | Enum   | 4            | H+24          |
|       |                        | ON   | 1            | Enable break detection (default)                                     |        |              |               |

<sup>1</sup>The OEM719 does not support hardware handshaking. Only transmit and receive lines exist for the OEM719 ports.

**Table 58: COM Port Identifiers**

| Binary | ASCII    | Description          | Applicable Receiver                 |
|--------|----------|----------------------|-------------------------------------|
| 1      | COM1     | COM port 1           | OEM719, OEM729, OEM7700, OEM7720    |
| 2      | COM2     | COM port 2           | OEM719, OEM729, OEM7700, OEM7720    |
| 3      | COM3     | COM port 3           | OEM729, OEM7700, OEM7720            |
| 6      | THISPORT | The current COM port | OEM719, OEM729, OEM7700, OEM7720    |
| 19     | COM4     | COM port 4           | OEM7700, OEM7720                    |
| 21     | IMU      | IMU COM port         | dependent on hardware configuration |
| 31     | COM5     | COM port 5           | OEM7700, OEM7720                    |
| 32     | COM6     | COM port 6           |                                     |
| 33     | BT1      | Bluetooth COM port   | dependent on hardware configuration |
| 34     | COM7     | COM port 7           |                                     |
| 35     | COM8     | COM port 8           |                                     |
| 36     | COM9     | COM port 9           |                                     |
| 37     | COM10    | COM port 10          |                                     |

**Table 59: Parity**

| Binary | ASCII | Description         |
|--------|-------|---------------------|
| 0      | N     | No parity (default) |
| 1      | E     | Even parity         |
| 2      | O     | Odd parity          |

**Table 60: Handshaking**

| Binary | ASCII | Description                   |
|--------|-------|-------------------------------|
| 0      | N     | No handshaking (default)      |
| 1      | XON   | XON/XOFF software handshaking |
| 2      | CTS   | CTS/RTS hardware handshaking  |

## 2.137 SERIALPROTOCOL

**Sets the protocol to be used by a serial port**

**Platform: OEM729**

On some OEM7 receiver cards, selected ports can support either RS-232 or RS-422 signaling protocol. The default protocol is RS-232. The **SERIALPROTOCOL** command is used to select the protocol (RS-232 or RS-422) supported on the port.



RS-422/RS-232 selection is available only on COM1 of the OEM729 or COM1 and COM2 on the PwrPak7 or PwrPak7-E1.

**Message ID: 1444**

**Abbreviated ASCII Syntax:**

```
SERIALPROTOCOL port protocol
```

**ASCII Example:**

```
SERIALPROTOCOL COM1 RS422
```

| Field | Field Type             | ASCII Value   | Binary Value | Description  | Format | Binary Bytes | Binary Offset |
|-------|------------------------|---|--------------|--|--------|--------------|---------------|
| 1     | SERIAL PROTOCOL header | -   | -            | Command header. See <i>Messages</i> on page 25 for more information.   | -      | H            | 0             |
| 2     | port                   | See <i>Table 61: Ports Supporting RS-422</i> on the next page |              | Select the COM port on which the protocol is being set.<br>The port that can be entered depends on the hardware platform being used. | Enum   | 4            | H             |
| 3     | protocol               | RS232   | 0            | Set the port to use RS-232 protocol  | Enum   | 4            | H+4           |
|       |                        | RS422   | 1            | Set the port to use RS-422 protocol  |        |              |               |



After switching a COM port from RS-232 to RS-422, send a carriage return (CR) on the newly configured port to flush the buffer prior to sending new commands on the port.



**Table 61: Ports Supporting RS-422**

| <b>OEM7 Receiver Type</b> | <b>Allowable Ports</b> | <b>Binary Value</b> |
|---------------------------|------------------------|---------------------|
| OEM719                    | None                   |                     |
| OEM729                    | COM1                   | 1                   |
| OEM7700                   | None                   |                     |
| OEM7720                   | None                   |                     |
| PwrPak7, PwrPak7-E1       | COM1                   | 1                   |
|                           | COM2                   | 2                   |

## 2.138 SETADMINPASSWORD

### *Sets the administration password*

**Platform:** OEM729, OEM7700, OEM7720, PwrPak7

This command sets the administration password used to log into various web services.

- The administration password is required for FTP access (no guest access).

The default password is the receiver's PSN. This password should be changed before connecting the receiver to a network.

**Message ID:** 1579

#### Abbreviated ASCII Syntax:

```
SETADMINPASSWORD oldpassword newpassword
```

#### Input example

```
SETADMINPASSWORD ABC123 XYZ789
```

| Field | Field Type               | ASCII Value                 | Binary Value | Description  | Format      | Binary Bytes  | Binary Offset |
|-------|--------------------------|-----------------------------|--------------|--|-------------|---------------|---------------|
| 1     | SETADMIN PASSWORD header | -                           | -            | Command header. See <i>Messages</i> on page 25 for more information. | -           | H             | 0             |
| 2     | OldPassword              | Maximum 28 character string |              | Previous password.   | String [28] | variable<br>1 | H             |
| 3     | NewPassword              | Maximum 28 character string |              | New password.  | String [28] | variable<br>1 | variable      |



This password can be restored to default (the receiver's PSN) by issuing the **FRESET USER\_ACCOUNTS** command (see *FRESET* on page 170).

<sup>1</sup>In the binary case, each string field needs to be NULL terminated and additional bytes of padding added to maintain 4-byte alignment, up to the maximum defined by the string size. The next defined field starts immediately at the next 4-byte alignment following the NULL.

## 2.139 SETAPPROXPOS

### *Sets an approximate position*

**Platform: OEM719, OEM729, OEM7500, OEM7700, OEM7720, PwrPak7, HxGN PIM7500**

This command sets an approximate latitude, longitude and height in the receiver. Estimating these parameters, when used in conjunction with an approximate time (see the **SETAPPROXTIME** command on the next page), can improve satellite acquisition times and Time To First Fix (TTFF). For more information about TTFF and Satellite Acquisition, refer to [An Introduction to GNSS](#) available on our website.

The horizontal position entered should be within 200 km of the actual receiver position. The approximate height is not critical and can normally be entered as zero. If the receiver cannot calculate a valid position within 2.5 minutes of entering an approximate position, the approximate position is ignored.

The approximate position is not visible in any position logs. It can be seen by issuing a SETAPPROXPOS log.

**Message ID: 377**

#### **Abbreviated ASCII Syntax:**

```
SETAPPROXPOS lat lon height
```

#### **Input Example:**

```
SETAPPROXPOS 51.116 -114.038 0
```



For an example on the use of this command, refer to the **SETAPPROXTIME** command on the next page.

| Field | Field Type          | ASCII Value          | Binary Value | Description  | Format | Binary Bytes | Binary Offset |
|-------|---------------------|----------------------|--------------|--|--------|--------------|---------------|
| 1     | SETAPPROXPOS header | -                    | -            | Command header. See <i>Messages</i> on page 25 for more information. | -      | H            | 0             |
| 2     | Lat                 | ± 90 degrees         |              | Approximate latitude   | Double | 8            | H             |
| 3     | Lon                 | ± 180 degrees        |              | Approximate longitude  | Double | 8            | H+8           |
| 4     | Height              | -1000 to +20000000 m |              | Approximate height   | Double | 8            | H+16          |

## 2.140 SETAPPROXTIME

### *Sets an approximate GPS reference time*

**Platform:** OEM719, OEM729, OEM7500, OEM7700, OEM7720, PwrPak7, HxGN PIM7500

This command sets an approximate time in the receiver. The receiver uses this time as system time until a coarse time can be acquired. This can be used in conjunction with an approximate position (see the **SETAPPROXPOS** command on the previous page) to improve Time To First Fix (TTFF). For more information TTFF and Satellite Acquisition, refer to [An Introduction to GNSS](#) available on our website.



The time entered should be within 10 minutes of the actual GPS reference time. If the week number entered does not match the broadcast week number, the receiver resets once it is tracking.

**Message ID: 102**

#### **Abbreviated ASCII Syntax:**

```
SETAPPROXTIME week sec
```

#### **Input Example:**

```
SETAPPROXTIME 1930 501232
```



Upon power up, the receiver does not know its position or time and therefore cannot use almanac information to aid satellite acquisition. You can set an approximate GPS reference time using the **SETAPPROXPOS** command (see page 331).

Approximate time and position may be used in conjunction with a current almanac to aid satellite acquisition. See the table below for a summary of the OEM7 family commands used to inject an approximated time or position into the receiver:

| Approximate | Command       |
|-------------|---------------|
| Time        | SETAPPROXTIME |
| Position    | SETAPPROXPOS  |

Base station aiding can help in these environments. A set of ephemerides can be injected into a rover station by broadcasting the RTCAEPHEM message from a base station. This is also useful in environments where there is frequent loss of lock. GPS ephemeris is three frames long within a sequence of five frames. Each frame requires 6 s of continuous lock to collect the ephemeris data. This gives a minimum of 18 s and a maximum of 36 s continuous lock time or when no recent ephemerides (new or stored) are available.

| Field | Field Type           | ASCII Value | Binary Value | Description  | Format | Binary Bytes | Binary Offset |
|-------|----------------------|-------------|--------------|--|--------|--------------|---------------|
| 1     | SETAPPROXTIME header | -           | -            | Command header. See <i>Messages</i> on page 25 for more information. | -      | H            | 0             |
| 2     | week                 | 0-9999      |              | GPS reference week number  | Ulong  | 4            | H             |
| 3     | sec                  | 0-604800    |              | Number of seconds into GPS reference week                            | Double | 8            | H+4           |

## 2.141 SETBASERECEIVERTYPE

### *Sets base receiver type*

**Platform:** OEM719, OEM729, OEM7500, OEM7700, OEM7720, PwrPak7, HxGN PIM7500

This command allows the user to specify the base receiver type to aid GLONASS ambiguity fixing in RTK. It can be used as a substitute for RTCM1033 messages that contains the information on the base receiver type. This command should be issued to the Rover.



An incorrect base type setting can significantly impair ambiguity resolution.

**Message ID:** 1374

#### **Abbreviated ASCII Syntax:**

```
SETBASERECEIVERTYPE base_type
```

#### **Factory Default:**

```
SETBASERECEIVERTYPE unknown
```

#### **ASCII Example:**

```
SETBASERECEIVERTYPE novatel
```

| Field | Field Type                     | ASCII Value | Binary Value | Description   | Format | Binary Bytes | Binary Offset |
|-------|--------------------------------|-------------|--------------|---|--------|--------------|---------------|
| 1     | SETBASERECEIVER<br>TYPE header | -           | -            | Command header.<br>See <i>Messages</i> on<br>page 25 for more<br>information. | -      | H            | 0             |
| 2     | base_type                      | unknown     | 0            | Unknown Base  | Enum   | 4            | H             |
|       |                                | novatel     | 1            | NovAtel Base  |        |              |               |
|       |                                | trimble     | 2            | Trimble Base  |        |              |               |
|       |                                | topcon      | 3            | Topcon Base   |        |              |               |
|       |                                | magellan    | 4            | Magellan Base   |        |              |               |
|       |                                | leica       | 5            | Leica Base  |        |              |               |

## 2.142 SETBESTPOSCRITERIA

### *Sets selection criteria for BESTPOS*

**Platform: OEM719, OEM729, OEM7500, OEM7700, OEM7720, PwrPak7, HxGN PIM7500**

Use this command to set the criteria for the **BESTPOS** log (see page 416) and choose between 2D and 3D standard deviation to obtain the best position from the **BESTPOS** log (see page 416). It also allows you to specify the number of seconds to wait before changing the position type. This delay provides a single transition that ensures position types do not skip back and forth.



The **SETBESTPOSCRITERIA** command is also used as the basis for the **UALCONTROL** command (see page 366) standard deviations.

**Message ID: 839**

#### Abbreviated ASCII Syntax:

```
SETBESTPOSCRITERIA type [delay]
```

#### Factory Default:

```
SETBESTPOSCRITERIA pos3d 0
```

#### Input Example:

```
SETBESTPOSCRITERIA pos2d 5
```

| Field | Field Type                 | ASCII Value  | Binary Value | Description  | Format | Binary Bytes | Binary Offset |
|-------|----------------------------|--|--------------|--|--------|--------------|---------------|
| 1     | SETBESTPOS CRITERIA header | -  | -            | Command header. See <i>Messages</i> on page 25 for more information.                       | -      | H            | 0             |
| 2     | type                       | See <i>Table 62: Selection Type</i> on the next page |              | Select a 2D or 3D standard deviation type to obtain the best position from the BESTPOS log | Enum   | 4            | H             |
| 3     | delay                      | 0 to 100 s   |              | Set the number of seconds to wait before changing the position type. Default=0             | Ulong  | 4            | H+4           |

**Table 62: Selection Type**

| <b>ASCII</b> | <b>Binary</b> | <b>Description</b>    |
|--------------|---------------|-----------------------|
| POS3D        | 0             | 3D standard deviation |
| POS2D        | 1             | 2D standard deviation |



## 2.143 SETDIFFCODEBIASES

### *Sets satellite differential code biases*

**Platform: OEM719, OEM729, OEM7500, OEM7700, OEM7720, PwrPak7, HxGN PIM7500**



Changing the biases may negatively affect positioning accuracy. NovAtel recommends that only advanced users modify the biases.

Use this command to set the differential code biases that correct pseudorange errors affecting the L1/L2 ionospheric corrections. Bias values are restricted to between -10 ns and +10 ns. A set of biases is included in the firmware and use of the biases is enabled by default. See also the **DIFFCODEBIASCONTROL** command on page 122.

The receiver uses the C/A code on L1 and the P code on L2 to calculate a dual-frequency ionospheric correction. However, the GNSS clock corrections are broadcast as if the P codes on both L1 and L2 are used to calculate this correction. The biases account for the differences between the P and C/A codes on L1 and improve the estimate of the ionospheric correction.

The biases are calculated by the International GNSS Service (IGS). Calculation details, analysis and results are available at <http://aiuws.unibe.ch/spec/dcb.php>. The most recent 30 day average bias values can be downloaded from [ftp://ftp.unibe.ch/aiub/CODE/CODE\\_FULL.DCB](ftp://ftp.unibe.ch/aiub/CODE/CODE_FULL.DCB).

**Message ID: 687**

#### **Abbreviated ASCII Syntax:**

```
SETDIFFCODEBIASES bias_type biases
```

#### **ASCII Example:**

```
<SETDIFFCODEBIASES COM1 2 91.0 UNKNOWN 0 0.470 02440020 365b 32768
<  GPS_C1P1 1.302 -1.326 1.360 1.649 1.357 1.586 0.776 -0.079 -0.123
0.888 -0.321 0.718 0.527 -0.720 1.193 -1.331 0.828 -1.061 -2.497 -2.106
-1.979 -2.747 -0.254 1.202 -0.716 0.077 -0.180 -1.059 1.269 -0.481
0.734 1.516 0.000 0.000 0.000 0.000 0.000 0.000 0.000 0.000
<SETDIFFCODEBIASES COM1 1 91.0 UNKNOWN 0 0.471 02440020 365b 32768
<  GLONASS_C1P1 -0.092 0.381 0.581 1.033 0.642 -0.561 0.794 0.899
0.380 -0.832 -0.358 -0.606 -2.181 0.023 1.135 0.346 0.009 0.384 -1.394
0.224 -0.022 -0.824 -0.133 -0.437 0.000 0.608 0.000 0.000 0.000 0.000
0.000 0.000 0.000 0.000 0.000 0.000 0.000 0.000 0.000 0.000
<SETDIFFCODEBIASES COM1 0 91.0 UNKNOWN 0 0.473 02440020 365b 32768
<  GPS_C2P2 1.358 0.000 -0.381 0.000 -0.344 -0.707 0.306 -1.068 0.624
1.480 0.000 -0.401 0.000 0.000 -0.169 0.0 00 0.236 0.000 0.000 0.000
0.000 0.000 0.000 0.051 -0.711 1.082 -0.128 0.000 -0.101 -0.483 -0.630
-0.015 0.000 0.0 00 0.000 0.000 0.000 0.000 0.000 0.000
```

| Field | Field Type                      | ASCII Value      | Binary Value | Description   | Format        | Binary Bytes | Binary Offset |
|-------|---------------------------------|------------------|--------------|---|---------------|--------------|---------------|
| 1     | SETDIFFCODE<br>BIASES<br>header | -                | -            | Command header.<br>See <i>Messages</i> on<br>page 25 for more<br>information. | -             | H            | 0             |
| 2     | bias_type                       | GPS_C1P1         | 0            | Code pair to which<br>biases refer  | Enum          | 4            | H             |
|       |                                 | GPS_C2P2         | 1            |   |               |              |               |
|       |                                 | GLONASS_<br>C1P1 | 2            |   |               |              |               |
| 3     | biases                          | -10 to +10 ns    |              | Array of 40 biases<br>(ns)  | Float<br>[40] | 160          | H+4           |

## 2.144 SETIONOTYPE

### *Enables ionospheric models*

**Platform:** OEM719, OEM729, OEM7500, OEM7700, OEM7720, PwrPak7, HxGN PIM7500

Use this command to set which ionospheric corrections model the receiver should use. If the selected model is not available, the receiver reverts to AUTO.



L1 only models automatically use SBAS ionospheric grid corrections, if available.

**Message ID:** 711

**Abbreviated ASCII Syntax:**

```
SETIONOTYPE model
```

**Factory Default:**

```
SETIONOTYPE auto
```

**ASCII Example:**

```
SETIONOTYPE Klobuchar
```



An ionotype of AUTO is recommended for PDP and GLIDE.

| Field | Field Type         | ASCII Value  | Binary Value | Description  | Format | Binary Bytes | Binary Offset |
|-------|--------------------|--|--------------|--|--------|--------------|---------------|
| 1     | SETIONOTYPE header | -  | -            | Command header. See <i>Messages</i> on page 25 for more information. | -      | H            | 0             |
| 2     | model              | See <i>Table 63: Ionospheric Correction Models</i> below |              | Choose an ionospheric corrections model                              | Enum   | 4            | H             |

**Table 63: Ionospheric Correction Models**

| ASCII     | Binary | Description                              |
|-----------|--------|--|
| NONE      | 0      | Don't use ionosphere modeling            |
| KLOBUCHAR | 1      | Use the Klobuchar model broadcast by GPS |

| <b>ASCII</b> | <b>Binary</b> | <b>Description</b>                                   |
|--------------|---------------|--|
| GRID         | 2             | Use the SBAS grid model                              |
| L1L2         | 3             | Use the L1/L2 model                                  |
| AUTO         | 4             | Automatically determine the ionospheric model to use |

## 2.145 SETNAV

### *Sets start and destination waypoints*

**Platform: OEM719, OEM729, OEM7500, OEM7700, OEM7720, PwrPak7, HxGN PIM7500**

This command permits entry of one set of navigation waypoints (see *Figure 9: Illustration of SETNAV Parameters* below). The origin (from) and destination (to) waypoint coordinates entered are considered on the ellipsoidal surface of the current datum (default wgs84). Once **SETNAV** has been set, monitor the navigation calculations and progress by observing messages in the **NAVIGATE** log (see page 597).

Track offset is the perpendicular distance from the great circle line drawn between the from lat-lon and to lat-lon waypoints. It establishes the desired navigation path or track, that runs parallel to the great circle line, which now becomes the offset track, and is set by entering the track offset value in metres. A negative track offset value indicates that the offset track is to the left of the great circle line track. A positive track offset value (no sign required) indicates the offset track is to the right of the great circle line track (looking from origin to destination). See *Figure 9: Illustration of SETNAV Parameters* below for clarification.

**Message ID: 162**

#### **Abbreviated ASCII Syntax:**

```
SETNAV fromlat fromlon tolat tolon trackoffset from-point to-point
```

#### **Factory Default:**

```
SETNAV 90.0 0.0 90.0 0.0 0.0 from to
```

#### **ASCII Example:**

```
SETNAV 51.1516 -114.16263 51.16263 -114.1516 -125.23 FROM TO
```

**Figure 9: Illustration of SETNAV Parameters**

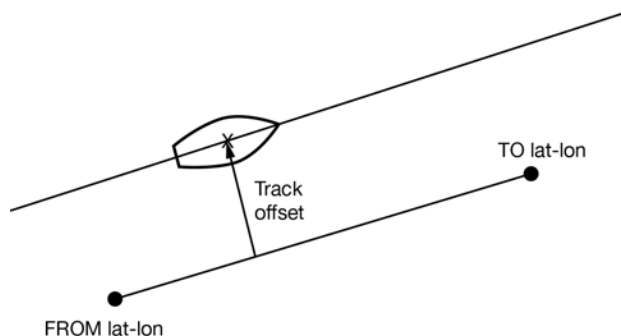

Consider the case of setting waypoints in a deformation survey along a dam. The surveyor enters the From and To point locations, on either side of the dam using the **SETNAV** command. They then use the NAVIGATE log messages to record progress and show where they are in relation to the From and To points.

| Field | Field Type    | ASCII Value          | Binary Value | Description  | Format         | Binary Bytes          | Binary Offset |
|-------|---------------|----------------------|--------------|--|----------------|-----------------------|---------------|
| 1     | SETNAV header | -                    | -            | Command header. See <i>Messages</i> on page 25 for more information.   | -              | H                     | 0             |
| 2     | fromlat       | ± 90 degrees         |              | Origin latitude in units of degrees/decimal degrees. A negative sign for South latitude. No sign for North latitude  | Double         | 8                     | H             |
| 3     | fromlon       | ± 180 degrees        |              | Origin longitude in units of degrees/decimal degrees. A negative sign for West longitude. No sign for East longitude   | Double         | 8                     | H+8           |
| 4     | tolat         | ± 90 degrees         |              | Destination latitude in units of degrees/decimal degrees   | Double         | 8                     | H+16          |
| 5     | tolon         | ± 180 degrees        |              | Destination longitude in units of degrees/decimal degrees  | Double         | 8                     | H+24          |
| 6     | trackoffset   | ± 1000 km            |              | Waypoint great circle line offset (in metres) establishes offset track. Positive indicates right of great circle line and negative indicates left of great circle line | Double         | 8                     | H+32          |
| 7     | from-point    | 5 characters maximum |              | ASCII origin station name  | String [max 5] | Variable <sup>1</sup> | H+40          |
| 8     | to-point      | 5 characters maximum |              | ASCII destination station name   | String [max 5] | Variable <sup>1</sup> | Variable      |

<sup>1</sup>In the binary case, each string field needs to be NULL terminated and additional bytes of padding added to maintain 4-byte alignment, up to the maximum defined by the string size. The next defined field starts immediately at the next 4-byte alignment following the NULL.

## 2.146 SETROVERID

### *Set ID for ALIGN rovers*

**Platform: OEM719, OEM729, OEM7500, OEM7700, OEM7720, PwrPak7, HxGN PIM7500**

This command sets the Rover ID output in the **ROVERPOS** log (see page 710), **HEADING2** log (see page 526), **ALIGNBSLNXYZ** log (see page 395) and **ALIGNBSLNENU** log (see page 393).

The default value for the ID is set using the last six characters of the receiver PSN Number. For example, if the receiver PSN number is DAB07170027, ID is set as R027, i.e., 17 is represented as R and last three characters are filled in as is. The fourth last character is ignored.



It is not guaranteed that each receiver will have a unique auto-generated ID. Use this command to set the ID in case the auto-generated ID overlaps with other rovers. It is the user's responsibility to ensure each receiver ID is unique (if they own multiple receivers). If the ID overlaps, use this command to set the ID.

#### **Message ID: 1135**

#### **Abbreviated ASCII Syntax:**

```
SETROVERID rovid
```

#### **Factory Default:**

If the receiver PSN is: DAB07170027

```
SETROVERID R027
```

#### **Input Example**

```
SETROVERID rov1
```

| Field | Field Type        | ASCII Value                   | Binary Value | Description  | Format     | Binary Bytes   | Binary Offset |
|-------|-------------------|-------------------------------|--------------|--|------------|----------------|---------------|
| 1     | SETROVERID header | -                             | -            | Command header. See <i>Messages</i> on page 25 for more information. | -          | H              | 0             |
| 2     | ID                | 4 Character String e.g., ROV1 |              | ID String (maximum 4 characters plus NULL)                           | String [5] | 5 <sup>1</sup> | H             |

<sup>1</sup>In the binary case, each string field needs to be NULL terminated and additional bytes of padding added to maintain 4-byte alignment, up to the maximum defined by the string size. The next defined field starts immediately at the next 4-byte alignment following the NULL.

## 2.147 SETTIMEBASE

*Sets primary and backup systems for time base*

**Platform:** OEM719, OEM729, OEM7500, OEM7700, OEM7720, PwrPak7, HxGN PIM7500

This command configures the primary and backup steering system(s) for timing. The primary system is the system that the receiver steers the clock to. Upon startup, the primary system must be present long enough to steer the clock to be valid once, otherwise, the backup system cannot be used. The backup system is used whenever the primary system is not present.

**Message ID:** 1237

### Abbreviated ASCII Syntax:

```
SETTIMEBASE primarysystem numbackups[system[timeout]]
```

### Factory Default:

For GLONASS only receiver:

```
SETTIMEBASE Glonass 0
```

For GPS capable receiver:

```
SETTIMEBASE GPS 1 AUTO 0
```

For BeiDou only receiver:

```
SETTIMEBASE beidou 0
```

### Input Example:

```
SETTIMEBASE gps 1 glonass 30
```

| Field | Field Type         | ASCII Value  | Binary Value | Description  | Format | Binary Bytes | Binary Offset |
|-------|--------------------|--|--------------|--|--------|--------------|---------------|
| 1     | SETTIMEBASE header | -  | -            | Command header. See <i>Messages</i> on page 25 for more information. | -      | H            | 0             |
| 2     | primarysystem      | <i>Table 64: System Used for Timing</i> on the next page |              | The primary system for steering the receiver clock                   | Enum   | 4            | H             |



| Field | Field Type           | ASCII Value   | Binary Value | Description   | Format | Binary Bytes | Binary Offset |
|-------|----------------------|---|--------------|---|--------|--------------|---------------|
| 3     | numbackups           | 0 or 4  |              | The number of records to follow.<br><b>Note:</b> When more than one backup system is specified, the backup systems are selected according to numeric order. | Ulong  | 4            | H+4           |
| 4     | system <sup>1</sup>  | <i>Table 64:<br/>System Used for<br/>Timing below</i> |              | The system to be used for backup  | Enum   | 4            | H+8           |
| 5     | timeout <sup>1</sup> | 0 to +4294967295 (seconds)                            |              | Duration that the backup system is used to steer the clock. 0 means ongoing   | Ulong  | 4            | H+12          |

**Table 64: System Used for Timing**

| Binary | ASCII             |
|--------|-------------------|
| 0      | GPS               |
| 1      | GLONASS           |
| 2      | GALILEO           |
| 3      | BEIDOU            |
| 4      | NAVIC             |
| 99     | AUTO <sup>2</sup> |

<sup>1</sup>The *system* and *timeout* fields can repeat.<sup>2</sup>AUTO is used only as a backup system (not available for primary system field).

## 2.148 SETTROPOMODEL

### *Sets Troposphere model*

**Platform:** OEM719, OEM729, OEM7500, OEM7700, OEM7720, PwrPak7, HxGN PIM7500

This command sets the troposphere model used to correct ranges used in the PSRPOS and PDPPOS solutions.

**Message ID:** 1434

**Abbreviated ASCII Syntax:**

```
SETTROPOMODEL model
```

**Factory Default:**

```
SETTROPOMODEL auto
```

**Input Example:**

```
SETTROPOMODEL none
```



Disabling the troposphere model may negatively affect positioning accuracy. NovAtel recommends that only advanced users modify this setting.

| Field | Field Type           | ASCII Value | Binary Value | Description  | Format | Binary Bytes | Binary Offset |
|-------|----------------------|-------------|--------------|--|--------|--------------|---------------|
| 1     | SETTROPOMODEL header | -           | -            | Command header. See <i>Messages</i> on page 25 for more information. | -      | H            | 0             |
| 2     | model                | NONE        | 1            | Do not apply any troposphere corrections                             | Enum   | 4            | H             |
|       |                      | AUTO        | 2            | Automatically use an appropriate model                               |        |              |               |

## 2.149 SETUTCLEAPSECONDS

### *Sets future leap seconds*

**Platform:** OEM719, OEM729, OEM7500, OEM7700, OEM7720, PwrPak7, HxGN PIM7500

This command allows the user to force the UTC offset to be updated according to the input date.

Leap seconds will occur at the end of the UTC day specified. The receiver will use the leap second set by this command until a leap second can be obtained over the air.

**Message ID: 1150**

#### **Abbreviated ASCII Syntax:**

```
SETUTCLEAPSECONDS seconds [futureweeknumber [futuredaynumber
[futureseconds]]]
```

#### **Input Example:**

```
SETUTCLEAPSECONDS 18 1929 7 18
```

| Field | Field Type                | ASCII Value | Binary Value | Description   | Format | Binary Bytes | Binary Offset |
|-------|---------------------------|-------------|--------------|---|--------|--------------|---------------|
| 1     | SETUTCLEAP SECONDS header | -           | -            | Command header. See <i>Messages</i> on page 25 for more information.                                      | -      | H            | 0             |
| 2     | Seconds <sup>1</sup>      | 0-          |              | Current UTC leap second   | Ulong  | 4            | H             |
| 3     | Futureweek number         | 0-10000     |              | GPS Week when future leap seconds will take effect  | Ulong  | 4            | H+4           |
| 4     | Futureday number          | 1-7         |              | Day of the week when future leap seconds will take effect   | Ulong  | 4            | H+8           |
| 5     | Futureseconds             | 0-          |              | Future leap second offset that will take effect at the end of the futuredaynumber of the futureweeknumber | Ulong  | 4            | H+12          |

<sup>1</sup>This value will only be applied if the UTC status in the TIME log is not Valid.

## 2.150 SOFTLOADCOMMIT

*Completes the SoftLoad process*

**Platform:** OEM719, OEM729, OEM7500, OEM7700, OEM7720, PwrPak7, HxGN PIM7500

This command completes the SoftLoad process by verifying the downloaded image and activating it. Refer to the [OEM7 Installation and Operation User Manual](#) for more information about the SoftLoad process.

This command can only be sent to the receiver when the **SOFTLOADSTATUS** log (see page 811) reports READY\_FOR\_DATA.

After issuing the **SOFTLOADCOMMIT** command the user must wait for the OK or ERROR command response before proceeding. This response is guaranteed to be output from the receiver within 300 seconds from the time the command was received by the receiver. If an error response is returned, consult the **SOFTLOADSTATUS** log on page 811 for more detail.

**Message ID:** 475

**Abbreviated ASCII Syntax:**

SOFTLOADCOMMIT

**Input Example:**

SOFTLOADCOMMIT

| Field | Field Type            | ASCII Value | Binary Value | Description  | Format | Binary Bytes | Binary Offset |
|-------|-----------------------|-------------|--------------|--|--------|--------------|---------------|
| 1     | SOFTLOADCOMMIT header | -           | -            | Command header. See <i>Messages</i> on page 25 for more information. | -      | H            | 0             |
| 2     | Reserved              | -           |              | Reserved. Set to 1 in the binary case                                | Enum   | 4            | H             |

## 2.151 SOFTLOADDATA

*Sends firmware image data to the receiver for the SoftLoad process*

**Platform:** OEM719, OEM729, OEM7500, OEM7700, OEM7720, PwrPak7, HxGN PIM7500

This command is only valid in binary mode.

This command is used to upload data to the receiver for the SoftLoad process. Refer to the [OEM7 Installation and Operation User Manual](#) for more information about the SoftLoad process.

After each **SOFTLOADDATA** command, the user must wait for the OK or ERROR command response before proceeding. This response is guaranteed to be output from the receiver within 15 seconds from the time the command was received by the receiver. If an error response is returned, consult the **SOFTLOADSTATUS** log on page 811 for more detail.

This command can only be sent to the receiver after the **SOFTLOADSREC** command (see page 353) or **SOFTLOADSETUP** command (see page 351) have sent the content of the S0 records from the start of a firmware \*.shex file. In these cases, the **SOFTLOADSTATUS** log (see page 811) reports READY\_FOR\_SETUP or READY\_FOR\_DATA.

**Message ID: 1218**

**Abbreviated ASCII Syntax:**

Not applicable

| Field | Field Type          | Binary Value | Description  | Format | Binary Bytes | Binary Offset |
|-------|---------------------|--------------|--|--------|--------------|---------------|
| 1     | SOFTLOADDATA header | -            | NovAtel binary message header  | -      | H            | 0             |
| 2     | offset              | -            | Offset of the data within the downloaded image   | Ulong  | 4            | H             |
| 3     | data length         | -            | Number of bytes of data. This must match the number of bytes contained within the "data" field | Ulong  | 4            | H+4           |
| 4     | data                | -            | Incoming data up to a maximum of 4096 bytes  | Uchar  | 4096         | H+8           |

## 2.152 SOFTLOADRESET

*Initiates a new SoftLoad process*

**Platform:** OEM719, OEM729, OEM7500, OEM7700, OEM7720, PwrPak7, HxGN PIM7500

This command restarts the SoftLoad process. Refer to the [OEM7 Installation and Operation User Manual](#) for more information about the SoftLoad process.

The command does not affect the flash and does not reset the receiver.

The **SOFTLOADRESET** command can be issued at any time. If it is issued while a SoftLoad process is currently in progress then that process is terminated and a new one is started. After the **SOFTLOADRESET** command is processed the SOFTLOADSTATUS log will report a status of READY\_FOR\_SETUP.

After issuing the **SOFTLOADRESET** command the user must wait for the OK or ERROR command response before proceeding. This response is guaranteed to be output from the receiver within 300 seconds from the time the command was received by the receiver. If an error response is returned, consult the **SOFTLOADSTATUS** log on page 811 for more detail.

**Message ID:** 476

**Abbreviated ASCII Syntax:**

```
SOFTLOADRESET
```

**Input Example:**

```
SOFTLOADRESET
```

| Field | Field Type           | ASCII Value | Binary Value | Description  | Format | Binary Bytes | Binary Offset |
|-------|----------------------|-------------|--------------|--|--------|--------------|---------------|
| 1     | SOFTLOADRESET header | -           | -            | Command header. See <i>Messages</i> on page 25 for more information. | -      | H            | 0             |
| 2     | Reserved             | -           | -            | Reserved. Set to 1 in the binary case                                | Enum   | 4            | H             |

## 2.153 SOFTLOADSETUP

***Sends configuration information to the receiver for the SoftLoad process***

**Platform: OEM719, OEM729, OEM7500, OEM7700, OEM7720, PwrPak7, HxGN PIM7500**

The **SOFTLOADSETUP** command can be used in place of the **SOFTLOADSREC** command when sending S0 Records. This command is meant to be used if the user requires that the entire SoftLoad process be performed in binary, but can also be used in ASCII or abbreviated ASCII. The examples below are given in abbreviated ASCII for simplicity.

Refer to the [OEM7 Installation and Operation User Manual](#) for more information about the SoftLoad process.

This command can only be sent to the receiver when the SOFTLOADSTATUS log reports READY\_FOR\_SETUP.

After each **SOFTLOADSETUP** command, the user must wait for the OK or ERROR command response before proceeding. This response is guaranteed to be output from the receiver within 15 seconds from the time the command was received by the receiver. If an error response is returned, consult the **SOFTLOADSTATUS** log on page 811 for more detail.

NovAtel S0 records use the following format: **S0~X~<<DATA>>**, where **X** is the Setup Type and **<<DATA>>** is a NULL terminated string. To convert from S0 record to the SOFTLOADSETUP command, convert the Setup Type to the appropriate Setup type enumeration, as described in *Table 65: Available Set Up Commands* on the next page, and copy the **<<DATA>>** string in to the Setup data string.

**Message ID: 1219**

**Abbreviated ASCII Syntax:**

```
SOFTLOADSETUP setuptype setupdata
```

**Input Example:**

```
SOFTLOADSETUP datatype "APP"
```

| Field | Field Type            | ASCII Value   | Binary Value | Description  | Format | Binary Bytes | Binary Offset |
|-------|-----------------------|---|--------------|--|--------|--------------|---------------|
| 1     | SOFTLOAD SETUP header | -   | -            | Command header. See <i>Messages</i> on page 25 for more information. | -      | H            | 0             |
| 2     | Setup type            | See <i>Table 65: Available Set Up Commands</i> on the next page |              | The type of setup command  | Enum   | 4            | H             |

| Field | Field Type | ASCII Value | Binary Value | Description  | Format          | Binary Bytes          | Binary Offset |
|-------|------------|-------------|--------------|--|-----------------|-----------------------|---------------|
| 3     | Setup data | -           | -            | ASCII setup data string. See <i>Table 65: Available Set Up Commands</i> below for details on this data. This data can be pulled from the S0 records of the hex file being loaded onto the receiver. If the ASCII form of this command is used, this string must be enclosed in double quotes (" ") | String<br>[512] | variable <sup>1</sup> | H+4           |

**Table 65: Available Set Up Commands**

| Binary | ASCII    | Description   |
|--------|----------|---|
| 1      | Platform | Comma separated list of platforms supported by the data to be uploaded. This corresponds to S0~P~. For example, the S-Record S0~P~OEM729,OEM7700,OEM719, translates to SOFTLOADSETUP PLATFORM "OEM729,OEM7700,OEM719"   |
| 2      | Version  | Version of the data to be uploaded. This corresponds to S0~V~. For example, the S-Record S0~V~OMP070400RN0000, translates to SOFTLOADSETUP VERSION "OMP070400RN0000"  |
| 3      | Datatype | Intended data block for the data to be uploaded. This corresponds to S0~T~. For example, the S-Record S0~T~APP, translates to SOFTLOADSETUP DATATYPE "APP"  |
| 4      | Authcode | PSN and AUTH code for the data to be uploaded. The format is: PSN:AuthCode.Note that since there are commas within the AuthCode, double quotes must surround the PSN:AuthCode string. For example:<br>SOFTLOADSETUP AUTHCODE "BFN10260115:T48JF2,W25DBM,JH46BJ,2WGHEMJ,8JW5TW,G2SR0RCCR,101114" |

<sup>1</sup>In the binary case, each string field needs to be NULL terminated and additional bytes of padding added to maintain 4-byte alignment, up to the maximum defined by the string size. The next defined field starts immediately at the next 4-byte alignment following the NULL.



## 2.154 SOFTLOADSREC

***Sends an S-Record to the receiver for the SoftLoad process***

**Platform: OEM719, OEM729, OEM7500, OEM7700, OEM7720, PwrPak7, HxGN PIM7500**

Use this command to send S-Records to the receiver for the SoftLoad process. Refer to the [OEM7 Installation and Operation User Manual](#) for more information about the SoftLoad process.

After each **SOFTLOADDATA** command, the user must wait for the OK or ERROR command response before proceeding. This response is guaranteed to be output from the receiver within 15 seconds from the time the command was received by the receiver. If an error response is returned, consult the **SOFTLOADSTATUS** log on page 811 for more detail.

This command can only be sent to the receiver when the SOFTLOADSTATUS log reports READY\_FOR\_SETUP or READY\_FOR\_DATA.

**Message ID: 477**

**Abbreviated ASCII Syntax:**

```
SOFTLOADSREC s-record
```

**Input Example:**

```
SOFTLOADSREC "S30900283C10FAA9F000EF"
```

| Field | Field Type          | ASCII Value | Binary Value | Description  | Format       | Binary Bytes          | Binary Offset |
|-------|---------------------|-------------|--------------|--|--------------|-----------------------|---------------|
| 1     | SOFTLOADSREC header | -           | -            | Command header. See <i>Messages</i> on page 25 for more information. | -            | H                     | 0             |
| 2     | SREC                | -           |              | ASCII S-Record string copied from firmware *.shex file               | String [515] | variable <sup>1</sup> | H             |
| 3     | Reserved            | -           | 1            | Reserved. Set to 1 in the binary case                                | Ulong        | 4                     | variable      |

<sup>1</sup>In the binary case, each string field needs to be NULL terminated and additional bytes of padding added to maintain 4-byte alignment, up to the maximum defined by the string size. The next defined field starts immediately at the next 4-byte alignment following the NULL.

## 2.155 STATUSCONFIG

### *Configures RXSTATUSEVENT mask fields*

**Platform:** OEM719, OEM729, OEM7500, OEM7700, OEM7720, PwrPak7, HxGN PIM7500

This command is used to configure the various status mask fields in the **RXSTATUSEVENT** log (see page 749). These masks can modify whether various status fields generate errors or event messages when they are set or cleared.

Receiver Errors automatically generate event messages. These event messages are output in **RXSTATUSEVENT** log (see page 749). It is also possible to have status conditions trigger event messages to be generated by the receiver. This is done by setting/clearing the appropriate bits in the event set/clear masks. The set mask tells the receiver to generate an event message when the bit becomes set. Likewise, the clear mask causes messages to be generated when a bit is cleared. To disable all these messages without changing the bits, simply UNLOG the **RXSTATUSEVENT** log (see page 749) on the appropriate ports. Refer also to the *Built in Status Tests* chapter in the [OEM7 Installation and Operation User Manual](#).

**Message ID:** 95

#### **Abbreviated ASCII Syntax:**

```
STATUSCONFIG type word mask
```

#### **Factory Default:**

```
STATUSCONFIG PRIORITY STATUS 0
STATUSCONFIG PRIORITY AUX1 0x00000008
STATUSCONFIG PRIORITY AUX2 0
STATUSCONFIG SET STATUS 0x00000000
STATUSCONFIG SET AUX1 0
STATUSCONFIG SET AUX2 0
STATUSCONFIG CLEAR STATUS 0x00000000
STATUSCONFIG CLEAR AUX1 0
STATUSCONFIG CLEAR AUX2 0
```

#### **ASCII Example:**

```
STATUSCONFIG SET STATUS 0028A51D
```



The receiver gives the user the ability to determine the importance of the status bits. In the case of the Receiver Status, setting a bit in the priority mask causes the condition to trigger an error. This causes the receiver to idle all channels, set the ERROR strobe line, flash an error code on the status LED, turn off the antenna (LNA power) and disable the RF hardware, the same as if a bit in the Receiver Error word is set. Setting a bit in an Auxiliary Status priority mask causes that condition to set the bit in the Receiver Status word corresponding to that Auxiliary Status.

| Field | Field Type          | ASCII Value         | Binary Value | Description  | Format | Binary Bytes | Binary Offset |
|-------|---------------------|---------------------|--------------|--|--------|--------------|---------------|
| 1     | STATUSCONFIG header | -                   | -            | Command header. See <i>Messages</i> on page 25 for more information. | -      | H            | 0             |
| 2     | type                | PRIORITY            | 0            | Replace the Priority mask  | Enum   | 4            | H             |
|       |                     | SET                 | 1            | Replace the Set mask   |        |              |               |
|       |                     | CLEAR               | 2            | Replace the Clear mask   |        |              |               |
| 3     | word                | STATUS              | 1            | Receiver Status word   | Enum   | 4            | H+4           |
|       |                     | AUX1                | 2            | Auxiliary 1 Status word  |        |              |               |
|       |                     | AUX2                | 3            | Auxiliary 2 Status word  |        |              |               |
|       |                     | AUX3                | 4            | Auxiliary 3 Status word  |        |              |               |
|       |                     | AUX4                | 5            | Auxiliary 4 Status word  |        |              |               |
| 4     | mask                | 8 digit hexadecimal |              | The hexadecimal bit mask   | Ulong  | 4            | H+8           |

## 2.156 STEADYLINE

### *Configures position mode matching*

**Platform: OEM719, OEM729, OEM7500, OEM7700, OEM7720, PwrPak7, HxGN PIM7500**

The STEADYLINE® functionality helps mitigate the discontinuities that often occur when a GNSS receiver changes positioning modes. The effect is especially evident when a receiver transitions from an RTK position mode solution to a lower accuracy “fall back” solution, such as DGPS, WAAS+GLIDE or even autonomous GLIDE. Smooth transitions are particularly important for agricultural steering applications where sudden jumps may be problematic.

The STEADYLINE internally monitors the position offsets between all the positioning modes present in the receiver. When the receiver experiences a position transition, the corresponding offset is applied to the output position to limit a potential real position jump. When the original accurate position type returns, the STEADYLINE algorithm will slowly transition back to the new accurate position at a default rate of 0.005 m/s. This creates a smoother pass-to-pass relative accuracy at the expense of a possible degradation of absolute accuracy.

For example, a receiver can be configured to do both RTK and GLIDE. If this receiver has a fixed RTK position and experiences a loss of correction data causing the loss of the RTK solution it will immediately apply the offset between the two position modes and uses the GLIDE position stability to maintain the previous trajectory. Over time the GLIDE (or non-RTK) position will experience some drift. Once the RTK position is achieved again the receiver will start using the RTK positions for position stability and will slowly transition back to the RTK positions at a default rate of 0.005 m/s.

If the position type is OUT\_OF\_BOUNDS (see the **UALCONTROL** command on page 366) then STEADYLINE is reset.

**Message ID: 1452**

#### **Abbreviated ASCII Syntax:**

```
STEADYLINE mode [transition_time]
```

#### **Factory Default:**

```
STEADYLINE disable
```

#### **ASCII Example:**

```
STEADYLINE prefer_accuracy 100
```

| Field | Field Type        | ASCII Value | Binary Value | Description  | Format | Binary Bytes | Binary Offset |
|-------|-------------------|-------------|--------------|--|--------|--------------|---------------|
| 1     | STEADYLINE header | -           | -            | Command header. See <i>Messages</i> on page 25 for more information. | -      | H            | 0             |

| Field | Field Type      | ASCII Value                                   | Binary Value | Description   | Format | Binary Bytes | Binary Offset |
|-------|-----------------|---|--------------|---|--------|--------------|---------------|
| 2     | mode            | See Table 66:<br><i>STEADYLINE Mode</i> below |              | STEADYLINE mode   | Enum   | 4            | H             |
| 3     | Transition time |   |              | Time over which solutions will transition in seconds. The minimum rate of change is 0.005 m/s regardless of this parameter. | Ulong  | 4            | H+4           |

**Table 66: STEADYLINE Mode**

| ASCII           | Binary | Description   |
|-----------------|--------|---|
| DISABLE         | 0      | Disable STEADYLINE (default)  |
| MAINTAIN        | 1      | Maintain the relative offset of the solution. There is no discontinuity in the position solution when the reference position type changes. Any offset in the position is maintained.  |
| TRANSITION      | 2      | Transition, at a user-configurable rate. There is no discontinuity in the position solution when the reference position type changes. The position will slowly transition to the new reference position type over the time period specified by the Transition time parameter. |
| RESET           | 3      | Reset the saved offsets   |
| PREFER_ACCURACY | 4      | TRANSITION when changing from less accurate reference positioning type to more accurate reference positioning type. MAINTAIN when changing from more accurate reference positioning type to a less accurate reference positioning type.                                       |
| UAL             | 5      | For use with the <b>UALCONTROL</b> command (see page 366):<br>TRANSITION when the position type is in WARNING MAINTAIN when the position type is in OPERATIONAL DISABLE when the position type is OUT_OF_BOUNDS   |

## 2.157 STEADYLINEDIFFERENTIALTIMEOUT

**Sets how long the receiver will report RTK/PPP after corrections are lost**

**Platform: OEM719, OEM729, OEM7500, OEM7700, OEM7720, PwrPak7, HxGN PIM7500**

Use this command to set how long STEADYLINE will report RTK or PPP solutions after a loss of corrections. If able, STEADYLINE will report an RTK or PPP solution until this timeout expires or until the RTK/PPP timeout expires, whichever is higher.

For example:

- If the **RTKTIMEOUT** is 60 seconds and the **STEADYLINEDIFFERENTIALTIMEOUT** is 300 seconds, STEADYLINE will report an RTK solution for 300 seconds.
- If the **RTKTIMEOUT** is 60 seconds and the **STEADYLINEDIFFERENTIALTIMEOUT** is 30 seconds, STEADYLINE will report an RTK solution for 60 seconds.

**Message ID: 2002**

**Abbreviated ASCII Syntax:**

```
STEADYLINEDIFFERENTIALTIMEOUT timeout
```

**Factory Default:**

```
STEADYLINEDIFFERENTIALTIMEOUT 60
```

**ASCII Example:**

```
STEADYLINEDIFFERENTIALTIMEOUT 300
```

| Field | Field Type                            | ASCII Value | Binary Value | Description  | Format | Binary Bytes | Binary Offset |
|-------|---------------------------------------|-------------|--------------|--|--------|--------------|---------------|
| 1     | STEADYLINE DIFFERENTIALTIMEOUT header | -           | -            | Command header. See <i>Messages</i> on page 25 for more information. | -      | H            | 0             |
| 2     | timeout                               | 5 to 1200   |              | Timeout period in seconds  | Float  | 4            | H             |

## 2.158 THISANTENNAPCO

*Sets the PCO model of this receiver*

**Platform:** OEM719, OEM729, OEM7500, OEM7700, OEM7720, PwrPak7, HxGN PIM7500

Use the **THISANTENNAPCO** command to set the Phase Center Offsets (PCO) for the given frequency of this receiver. The Offsets are defined as North, East and Up from the Antenna Reference Point to the Frequency Phase Center in mm.

**Message ID:** 1417

**Abbreviated ASCII Syntax:**

```
THISANTENNAPCO Frequency [NorthOffset] [EastOffset] [UpOffset]
```

**ASCII Example:**

```
THISANTENNAPCO GPSL1 0.61 1.99 65.64
```

| Field | Field Type            | ASCII Value                                    | Binary Value | Description  | Format | Binary Bytes | Binary Offset |
|-------|-----------------------|--|--------------|--|--------|--------------|---------------|
| 1     | THISANTENNAPCO header | -  | -            | Command header. See <i>Messages</i> on page 25 for more information. | -      | H            | 0             |
| 2     | Frequency             | See <i>Table 18: Frequency Type</i> on page 80 |              | The frequency for which the phase center offsets are valid.          | Enum   | 4            | H             |
| 3     | North Offset          |  |              | NGS standard Phase Center North Offset (millimetres). <sup>1</sup>   | Double | 8            | H+4           |
| 4     | East Offset           |  |              | NGS standard Phase Center East Offset (millimetres). <sup>1</sup>    | Double | 8            | H+12          |
| 5     | Up Offset             |  |              | NGS standard Phase Center Up Offset (millimetres). <sup>1</sup>      | Double | 8            | H+20          |

<sup>1</sup>Enter values as per the NGS standards and tables to define which direction is plus or minus.

## 2.159 THISANTENNAPCV

*Sets the PCV model of this receiver*

**Platform: OEM719, OEM729, OEM7500, OEM7700, OEM7720, PwrPak7, HxGN PIM7500**

Use the **THISANTENNAPCV** command to set the Phase Center Variation (PVC) for the given frequency of this receiver. The Phase Center Variation entries follow the NGS standard and correspond to the phase elevation at 5 degree increments starting at 90 degrees and decreasing to 0.

**Message ID: 1418**

**Abbreviated ASCII Syntax:**

```
THISANTENNAPCV Frequency[PCVArray]
```

**ASCII Example:**

```
THISANTENNAPCV GPSL1 0.00 -0.020 -0.07 -0.15 -0.24 -0.34 -0.43 -0.51 -0.56 -  
0.61 -0.65 -0.69 -0.69 -0.62 -0.44 -0.13 0.28 0.70 1.02
```

| Field | Field Type            | ASCII Value                                    | Binary Value | Description  | Format            | Binary Bytes | Binary Offset |
|-------|-----------------------|--|--------------|--|-------------------|--------------|---------------|
| 1     | THISANTENNAPCV header | -  | -            | Command header. See <i>Messages</i> on page 25 for more information.   | -                 | H            | 0             |
| 2     | Frequency             | See <i>Table 18: Frequency Type</i> on page 80 |              | The frequency for which the phase center variations is valid.  | Enum              | 4            | H             |
| 3     | PCV Array             |  |              | NGS standard 19 Element array of Phase Center Variations for phase variation for 5 degree elevation increments starting at 90 degrees and decreasing to 0. The variances are entered in millimetres. | Double Array [19] | 152          | H+4           |



## 2.160 THISANTENNATYPE

*Sets the antenna type of this receiver*

**Platform:** OEM719, OEM729, OEM7500, OEM7700, OEM7720, PwrPak7, HxGN PIM7500

Use the **THISANTENNATYPE** command to set the antenna type of this receiver. The antenna type and radome type are the NGS names for the antenna.



When antenna type is set using this command, the receiver will look up and use the Phase Center Variations and Phase Center Offsets from an internal table.

**Message ID:** 1420

**Abbreviated ASCII Syntax:**

```
THISANTENNATYPE AntennaType [RadomeType]
```

**ASCII Example:**

```
THISANTENNATYPE NOV702
```

| Field | Field Type             | ASCII Value                                  | Binary Value | Description  | Format | Binary Bytes | Binary Offset |
|-------|------------------------|--|--------------|--|--------|--------------|---------------|
| 1     | THISANTENNATYPE header | -  | -            | Command header. See <i>Messages</i> on page 25 for more information. | -      | H            | 0             |
| 2     | antenna type           | See <i>Table 19: Antenna Type</i> on page 83 |              | NGS Antenna Name   | Enum   | 4            | H             |
| 3     | radome type            | See <i>Table 20: Radome Type</i> on page 91  |              | NGS Radome Name  | Enum   | 4            | H+4           |

## 2.161 TRACKSV

### *Overrides automatic satellite assignment criteria*

**Platform: OEM719, OEM729, OEM7500, OEM7700, OEM7720, PwrPak7, HxGN PIM7500**

This command is used to override the automatic satellite/channel assignment for all satellites with manual instructions.

**Message ID: 1326**

#### Abbreviated ASCII Syntax:

```
TRACKSV system SVID condition
```

#### Factory Default:

GPS, GLONASS, GALILEO, QZSS, BeiDou and NavIC default = GOODHEALTH

SBAS default = ANYHEALTH

TRACKSV QZSS 198 NEVER

TRACKSV QZSS 202 NEVER



QZSS 198 and QZSS 202 are excluded because they are defined as test PRNs in the QZSS ICD.

#### Input Example:

```
TRACKSV GALILEO 0 ANYHEALTH
```



For dual antenna receivers, this command applies to both the primary and secondary antennas.

| Field | Field Type     | ASCII Value  | Binary Value | Description  | Format | Binary Bytes | Binary Offset |
|-------|----------------|--|--------------|--|--------|--------------|---------------|
| 1     | TRACKSV header | -  | -            | Command header. See <i>Messages</i> on page 25 for more information.                           | -      | H            | 0             |
| 2     | System         | See <i>Table 102: Satellite System</i> on page 532 |              | System that the SVID belongs to  | Enum   | 4            | H             |
| 3     | SVID           | Refer to <i>PRN Numbers</i> on page 46             |              | Satellite SVID number<br>"0" is allowed and applies to all SVIDs for the specified system type | Ulong  | 4            | H+4           |

| Field | Field Type | ASCII Value  | Binary Value | Description        | Format | Binary Bytes | Binary Offset |
|-------|------------|--|--------------|--------------------|--------|--------------|---------------|
| 4     | Condition  | See <i>Table 67: TRACKSV Command Condition</i> below |              | Tracking condition | Enum   | 4            | H+8           |

**Table 67: TRACKSV Command Condition**

| Binary | ASCII      | Description  |
|--------|------------|--|
| 1      | NEVER      | Never track this satellite   |
| 2      | GOODHEALTH | Track this satellite if the health is indicated as healthy in both the almanac and ephemeris |
| 3      | ANYHEALTH  | Track this satellite regardless of health status   |
| 4      | ALWAYS     | Always track this satellite  |

## 2.162 TUNNELESCAPE

### *Breaks out of an established tunnel*

**Platform: OEM719, OEM729, OEM7500, OEM7700, OEM7720, PwrPak7, HxGN PIM7500**

The tunnel escape sequence feature allows you to break out of a tunnel between two ports by sending a predefined sequence of bytes through the tunnel in-line with the data stream.

Use the **TUNNELESCAPE** command to specify the tunnel escape sequence. The escape sequence is applied independently to all active tunnels. Use the **SAVECONFIG** command (see page 311) to save the escape sequence in case of a power cycle.

This command is used to define an escape sequence that, when detected in a byte stream between any two COM (or AUX) ports, resets the interface mode to **NOVATEL NOVATEL** on those ports. The baud rate and other port parameters remain unaffected.

The **TUNNELESCAPE** command accepts three parameters. The first is the *switch* parameter with **ENABLE** or **DISABLE** options. The second is the *length* parameter. It is a number from 1 to 8 and must be present if the switch parameter is set to **ENABLE**. The third parameter, *esc seq*, consists of a series of pairs of digits representing hexadecimal numbers, where the number of pairs are equal to the value entered for the second parameter. The series of hexadecimal pairs of digits represent the escape sequence. The receiver detects a sequence in a tunnel exactly as it was entered.

For example, the command **TUNNELESCAPE ENABLE 4 61626364** searches for the bytes representing "abcd" in a tunnel stream. **TUNNELESCAPE ENABLE 3 AA4412** searches for the NovAtel binary log sync bytes.

You must first set up a tunnel. For example, create a tunnel between COM1 and COM2 by entering **INTERFACEMODE COM1 TCOM2 NONE OFF**. The commands can be entered in any order.



1. All bytes, leading up to and including the escape sequence, pass through the tunnel before it is reset. Therefore, the escape sequence is the last sequence of bytes that passes through the tunnel. Configure the receiver to detect and interpret the escape sequence. For example, use this information to reset equipment or perform a shut-down process.
2. The receiver detects the escape sequence in all active tunnels in any direction.
3. Create tunnels using the **INTERFACEMODE** command (see page 189).

**Message ID: 962**

**Abbreviated ASCII Syntax:**

```
TUNNELESCAPE switch length escseq
```

**Factory Default:**

```
TUNNELESCAPE disable 0
```

**ASCII Example:**

```
TUNNELESCAPE enable 1 aa
```

| Field | Field Type          | ASCII Value | Binary Value | Description   | Format    | Binary Bytes | Binary Offset |
|-------|---------------------|-------------|--------------|---|-----------|--------------|---------------|
| 1     | TUNNELESCAPE header | -           | -            | Command header. See <i>Messages</i> on page 25 for more information.            | H         | 0            | -             |
| 2     | switch              | DISABLE     | 0            | Enable or disable the tunnel escape mode  | Enum      | 4            | H             |
|       |                     | ENABLE      | 1            |   |           |              |               |
| 3     | length              | 1 to 8      |              | Specifies the number of hex bytes to follow                                     | Ulong     | 4            | H+4           |
| 4     | escseq              |             |              | Escape sequence where Hex pairs are entered without spaces, for example, AA4412 | Uchar [8] | 8            | H+8           |



If using the **SAVECONFIG** command (see page 311) in NovAtel Connect, ensure all windows other than the *Console* window are closed. If open, NovAtel Connect also saves log commands used for its various windows. This results in unnecessary data being logged.

## 2.163 UALCONTROL

### *Setup User Accuracy levels*

**Platform: OEM719, OEM729, OEM7500, OEM7700, OEM7720, PwrPak7, HxGN PIM7500**

The **UALCONTROL** command is used to define User Accuracy Levels. User accuracy levels are user defined standard deviations thresholds, used to determine solution acceptability. Issuing the **UALCONTROL** command causes the BESTPOS and GPGGA solution types to be controlled via the specified thresholds, rather than by the solution source or mode. The new solution types are described in the table below.

**Table 68: User Accuracy Level Supplemental Position Types and NMEA Equivalents**

| Value | BESTPOS Position Type | NMEA Equivalent |
|-------|-----------------------|-----------------|
| 70    | OPERATIONAL           | 4               |
| 71    | WARNING               | 5               |
| 72    | OUT_OF_BOUNDS         | 1               |

The **SETBESTPOSCRITERIA** command (see page 335) determines which standard deviations are compared against the provided thresholds. When using the **STEADYLINE** command (see page 356) together with the **UALCONTROL** command, the UAL setting is recommended. Refer to *Table 66: STEADYLINE Mode* on page 357 for mode details.



UAL is useful for applications that rely upon specific solutions types being present in the BESTPOS or GPGGA logs. For example, if an agricultural steering system commonly requires an RTK fixed GPGGA solution type (4) to operate, and interruptions in RTK conventionally cause the GPGGA to switch to another solution type. This causes the steering system to disengage. However, while using **STEADYLINE**, solutions with fixed RTK accuracy can be maintained by GLIDE even if RTK is interrupted. **UALCONTROL** can be used to ensure that the required solution type is maintained through such interruptions, permitting the steering system to function continuously.

**Message ID: 1627**

**Abbreviated ASCII Syntax:**

```
UALCONTROL Action [Operational_limit] [Warning_limit]
```

**Factory Default:**

```
UALCONTROL disable
```

**ASCII Example:**

<sup>1</sup>As reported in the **BESTPOS** log (see page 416).

<sup>2</sup>Refers to the GPGGA quality indicator (see *GPGGA* on page 497 for details).

UALCONTROL enable 0.10 0.20

| Field | Field Type        | ASCII Value | Binary Value | Description  | Format | Binary Bytes | Binary Offset |
|-------|-------------------|-------------|--------------|--|--------|--------------|---------------|
| 1     | UALCONTROL header | -           | -            | Command header. See <i>Messages</i> on page 25 for more information.   | -      | H            | 0             |
| 2     | Action            | DISABLE     | 0            | Disables this feature  | Enum   | 4            | H             |
|       |                   | ENABLE      | 1            | Replace BESTPOS and GPGGA position types with OPERATIONAL, WARNING or OUT_OF_BOUNDS based on the entered standard deviations (refer to <i>Table 68: User Accuracy Level Supplemental Position Types and NMEA Equivalents</i> on the previous page) |        |              |               |
|       |                   | CLEAR       | 2            | Disable this feature and reset the entered standard deviations.  |        |              |               |
| 3     | Operational Limit |             |              | Standard deviation in metres to report OPERATIONAL   | Double | 8            | H+4           |
| 4     | Warning Limit     |             |              | Standard deviation in metres to report WARNING<br><b>Note:</b> OUT_OF_BOUND reports when the standard deviation exceeds this value   | Double | 8            | H+12          |

## 2.164 UNASSIGN

*Unassigns a previously assigned channel*

**Platform:** OEM719, OEM729, OEM7500, OEM7700, OEM7720, PwrPak7, HxGN PIM7500

This command cancels a previously issued **ASSIGN** command (see page 66) and the SV channel reverts to automatic control (the same as **ASSIGN AUTO**).

**Message ID:** 29

**Abbreviated ASCII Syntax:**

```
UNASSIGN channel [state]
```

**Input Example:**

```
UNASSIGN 11
```



Issuing the **UNASSIGN** command to a channel that was not previously assigned by the **ASSIGN** command (see page 66) has no effect.



For dual antenna receivers, when using the UNASSIGN command for SV channels on the primary antenna, the SV channel count goes from 0 to N-1, where N is the number of channels in the primary antenna channel configuration. When using the UNASSIGN command for channels on the secondary antenna, the SV channel count begins at N and goes to N+(M-1), where M is the number of channels in the secondary antenna SV channel configuration.

| Field | Field Type      | ASCII Value  | Binary Value | Description  | Format | Binary Bytes | Binary Offset |
|-------|-----------------|--|--------------|--|--------|--------------|---------------|
| 1     | UNASSIGN header | -  | -            | Command header. See <i>Messages</i> on page 25 for more information. | -      | H            | 0             |
| 2     | channel         | 0 to n, where n is the number of the last channel in the current channel configuration |              | Channel number reset to automatic search and acquisition mode        | Ulong  | 4            | H             |



---

| Field | Field Type | ASCII Value  | Binary Value | Description                                  | Format | Binary Bytes | Binary Offset |
|-------|------------|--|--------------|--|--------|--------------|---------------|
| 3     | state      | These return SV channel control to the automatic search engine immediately (see <i>Table 14: Channel State</i> on page 68) |              | Set the SV channel state (currently ignored) | Enum   | 4            | H+4           |

## 2.165 UNASSIGNALL

*Unassigns all previously assigned channels*

**Platform:** OEM719, OEM729, OEM7500, OEM7700, OEM7720, PwrPak7, HxGN PIM7500

This command cancels all previously issued **ASSIGN** commands for all SV channels (same as **ASSIGNALL AUTO**). Tracking and control for each SV channel reverts to automatic mode.

**Message ID:** 30

**Abbreviated ASCII Syntax:**

```
UNASSIGNALL [system]
```

**Input Example:**

```
UNASSIGNALL GPS
```



Issuing the **UNASSIGNALL** command has no effect on channels that were not previously assigned using the **ASSIGN** command.

| Field | Field Type         | ASCII Value                                    | Binary Value | Description  | Format | Binary Bytes | Binary Offset |
|-------|--------------------|--|--------------|--|--------|--------------|---------------|
| 1     | UNASSIGNALL header | -  | -            | Command header. See <i>Messages</i> on page 25 for more information.           | -      | H            | 0             |
| 2     | system             | See <i>Table 15: Channel System</i> on page 70 |              | System that will be affected by the <b>UNASSIGNALL</b> command (default = ALL) | Enum   | 4            | H             |

## 2.166 UNDULATION

### *Chooses undulation*

**Platform: OEM719, OEM729, OEM7500, OEM7700, OEM7720, PwrPak7, HxGN PIM7500**

This command permits you to enter a specific geoidal undulation value. In the option field, the EGM96 table provides ellipsoid heights at a 0.5° by 0.5° spacing while the OSU89B is implemented at a 2° by 3° spacing. In areas of rapidly changing elevation, you could be operating somewhere within the 2° by 3° grid with an erroneous height. EGM96 provides a more accurate model of the ellipsoid which results in a denser grid of heights. It is also more accurate because the accuracy of the grid points themselves has also improved from OSU89B to EGM96. For example, the default grid (EGM96) is useful where there are underwater canyons, steep drop-offs or mountains.

The undulation values reported in the position logs are in reference to the ellipsoid of the chosen datum.

Refer to the application note [APN-006 Geoid Issue](#), available on our website [www.novatel.com/support/search/](http://www.novatel.com/support/search/) for a description of the relationships in *Figure 10: Illustration of Undulation* below.

**Figure 10: Illustration of Undulation**

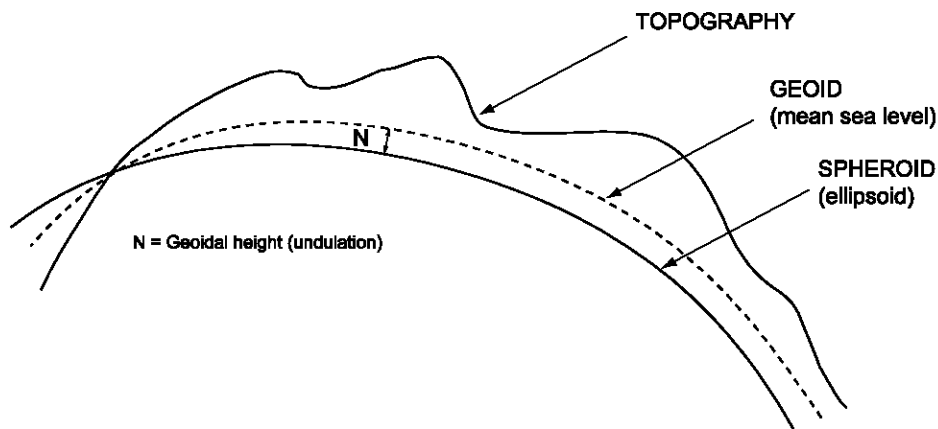

**Message ID: 214**

#### **Abbreviated ASCII Syntax:**

```
UNDULATION option [separation]
```

#### **Factory Default:**

```
UNDULATION egm96 0.0000
```

#### **ASCII Example 1:**

```
UNDULATION osu89b
```

#### **ASCII Example 2:**

UNDULATION USER -5.599999905

| Field | Field Type        | ASCII Value | Binary Value | Description   | Format | Binary Bytes | Binary Offset |
|-------|-------------------|-------------|--------------|---|--------|--------------|---------------|
| 1     | UNDULATION header | -           | -            | Command header. See <i>Messages</i> on page 25 for more information.  | -      | H            | 0             |
| 2     | option            | USER        | 1            | Use the user specified undulation value                               | Enum   | 4            | H             |
|       |                   | OSU89B      | 2            | Use the OSU89B undulation table                                       |        |              |               |
|       |                   | EGM96       | 3            | Use global geoidal height model EGM96 table                           |        |              |               |
| 3     | separation        | ±1000.0 m   |              | The undulation value (required for the USER option) (default = 0.000) | Float  | 4            | H+4           |

## 2.167 UNLOCKOUT

*Reinstates a satellite in the solution*

**Platform:** OEM719, OEM729, OEM7500, OEM7700, OEM7720, PwrPak7, HxGN PIM7500

This command allows a satellite which has been previously locked out (**LOCKOUT** command on page 214) to be reinstated in the solution computation. If more than one satellite is to be reinstated, this command must be reissued for each satellite reinstatement.

**Message ID:** 138

**Abbreviated ASCII Syntax:**

```
UNLOCKOUT prn
```

**Input Example:**

```
UNLOCKOUT 8
```



The **UNLOCKOUT** command is used to reinstate a satellite while leaving other locked out satellites unchanged.

This command can be used for GPS, GLONASS, SBAS and QZSS.

| Field | Field Type       | ASCII Value                            | Binary Value | Description  | Format | Binary Bytes | Binary Offset |
|-------|------------------|--|--------------|--|--------|--------------|---------------|
| 1     | UNLOCKOUT header | -                                      | -            | Command header. See <i>Messages</i> on page 25 for more information. | -      | H            | 0             |
| 2     | prn              | Refer to <i>PRN Numbers</i> on page 46 |              | A single satellite PRN number to be reinstated                       | Ulong  | 4            | H             |

## 2.168 UNLOCKOUTALL

*Reinstates all previously locked out satellites*

**Platform:** OEM719, OEM729, OEM7500, OEM7700, OEM7720, PwrPak7, HxGN PIM7500

This command allows all satellites which have been previously locked out (**LOCKOUT** command on page 214 or **LOCKOUTSYSTEM** command on page 215) to be reinstated in the solution computation.

**Message ID:** 139

**Abbreviated ASCII Syntax:**

UNLOCKOUTALL

**Input Example:**

UNLOCKOUTALL

| Field | Field Type          | ASCII Value | Binary Value | Description  | Format | Binary Bytes | Binary Offset |
|-------|---------------------|-------------|--------------|--|--------|--------------|---------------|
| 1     | UNLOCKOUTALL header | -           | -            | Command header. See <i>Messages</i> on page 25 for more information. | -      | H            | 0             |

## 2.169 UNLOCKOUTSYSTEM

*Reinstates previously locked out system*

**Platform:** OEM719, OEM729, OEM7500, OEM7700, OEM7720, PwrPak7, HxGN PIM7500

This command allows a system which has been previously locked out (refer to the **LOCKOUTSYSTEM** command on page 215) to be reinstated in the solution computation.



If more than one system is to be reinstated, this command must be reissued for each system reinstatement.

**Message ID: 908**

**Abbreviated ASCII Syntax:**

```
UNLOCKOUTSYSTEM system
```

**Input Example:**

```
UNLOCKOUTSYSTEM glonass
```



The **UNLOCKOUTSYSTEM** command is used to reinstate a system while leaving other locked out systems unchanged.

| Field | Field Type              | ASCII Value  | Binary Value | Description  | Format | Binary Bytes | Binary Offset |
|-------|-------------------------|--|--------------|--|--------|--------------|---------------|
| 1     | UNLOCKOUT SYSTEM header | -  | -            | Command header. See <i>Messages</i> on page 25 for more information. | -      | H            | 0             |
| 2     | system                  | See <i>Table 102: Satellite System</i> on page 532 |              | A single satellite system to be reinstated                           | Enum   | 4            | H             |

## 2.170 UNLOG

*Removes a log from logging control*

**Platform:** OEM719, OEM729, OEM7500, OEM7700, OEM7720, PwrPak7, HxGN PIM7500

This command is used to remove a specific log request from the system.

**Message ID:** 36

**Abbreviated ASCII Syntax:**

```
UNLOG [port] message
```

**Input Example:**

```
UNLOG com1 bestposa
```

```
UNLOG bestposa
```



The **UNLOG** command is used to remove one or more logs while leaving other logs unchanged.

### 2.170.1 Binary

| Field | Field Name            | Binary Value   | Description                            | Format | Binary Bytes | Binary Offset |
|-------|-----------------------|--|--|--------|--------------|---------------|
| 1     | UNLOG (binary) header | (See Table 3: Binary Message Header Structure on page 30)  | This field contains the message header | -      | H            | 0             |
| 2     | port                  | See Table 4: Detailed Port Identifier on page 31 (decimal port values greater than 16 may be used) | Port to which log is being sent        | Enum   | 4            | H             |
| 3     | message               | Any valid message ID   | Message ID of log to output            | Ushort | 2            | H+4           |



| Field | Field Name   | Binary Value  | Description         | Format | Binary Bytes | Binary Offset |
|-------|--------------|---|---------------------|--------|--------------|---------------|
| 4     | message type | Bits 0-4 = Reserved<br>Bits 5-6 = Format<br>00 = Binary<br>01 = ASCII<br>10 = Abbreviated ASCII, NMEA<br>11 = Reserved<br>Bit 7 = Response Bit ( <i>Message Responses</i> on page 42)<br>0 = Original Message<br>1 = Response Message | Message type of log | Char   | 1            | H+6           |
| 5     | Reserved     |   |                     | Char   | 1            | H+7           |

### 2.170.2 ASCII

| Field | Field Type           | ASCII Value   | Binary Value | Description   | Format | Binary Bytes | Binary Offset |
|-------|----------------------|---|--------------|---|--------|--------------|---------------|
| 1     | UNLOG (ASCII) header | -   | -            | This field contains the command name or the message header depending on whether the command is abbreviated ASCII or ASCII, respectively | -      | H            | 0             |
| 2     | port                 | See <i>Table 4: Detailed Port Identifier</i> on page 31 (decimal port values greater than 16 may be used) |              | Port to which log is being sent (default = THISPORT)  | Enum   | 4            | H             |
| 3     | message              | Message Name  | N/A          | Message Name of log to be disabled  | Ulong  | 4            | H+4           |

## 2.171 UNLOGALL

*Removes all logs from logging control*

**Platform:** OEM719, OEM729, OEM7500, OEM7700, OEM7720, PwrPak7, HxGN PIM7500

If [*port*] is specified, this command disables all logs on the specified port only. All other ports are unaffected. If [*port*] is not specified this command defaults to the ALL\_PORTS setting.

**Message ID:** 38

**Abbreviated ASCII Syntax:**

```
UNLOGALL [port] [held]
```

**Input Example:**

```
UNLOGALL com2_15
```

```
UNLOGALL true
```



The **UNLOGALL** command is used to remove all log requests currently in use.

| Field | Field Type      | ASCII Value  | Binary Value | Description  | Format | Binary Bytes | Binary Offset |
|-------|-----------------|--|--------------|--|--------|--------------|---------------|
| 1     | UNLOGALL header | -  | -            | Command header. See <i>Messages</i> on page 25 for more information. | -      | H            | 0             |
| 2     | port            | See <i>Table 4: Detailed Port Identifier</i> on page 31 (decimal values greater than 16 may be used) |              | Port to clear (default = ALL_PORTS)                                  | Enum   | 4            | H             |
| 3     | held            | FALSE  | 0            | Does not remove logs with the HOLD parameter (default)               | Bool   | 4            | H+4           |
|       |                 | TRUE   | 1            | Removes previously held logs, even those with the HOLD parameter     |        |              |               |

## 2.172 USBSTICKEJECT

### *Prepare a USB stick for removal*

**Platform:** OEM719, OEM729, OEM7500, OEM7700, OEM7720, PwrPak7, HxGN PIM7500

Use this command to unmount the USB stick and prepare it for safe physical removal.

This command may fail with a *Busy* error if there is an ongoing USB stick mounting or unmounting operation.

The **FILETRANSFERSTATUS** log (see page 461) indicates the *USBSTICK UNMOUNTED* status when it is safe to physically remove the stick. This may take up to 10 seconds.

**Message ID:** 2115

**Abbreviated ASCII Syntax:**

```
USBSTICKEJECT
```

**Example:**

```
USBSTICKEJECT
```

| Field | Field Type           | ASCII Value | Binary Value | Description  | Format | Binary Bytes | Binary Offset |
|-------|----------------------|-------------|--------------|--|--------|--------------|---------------|
| 1     | USBSTICKEJECT header | -           | -            | Command header. See <i>Messages</i> on page 25 for more information. | -      | H            | 0             |

## 2.173 USERDATUM

### *Sets user customized datum*

**Platform: OEM719, OEM729, OEM7500, OEM7700, OEM7720, PwrPak7, HxGN PIM7500**

This command permits entry of customized ellipsoidal datum parameters. This command is used in conjunction with the **DATUM** command (see page 114). If used, the command default setting for **USERDATUM** is WGS84.

When the **USERDATUM** command is entered, the **USEREXPDATUM** command on page 382 is then issued internally with the **USERDATUM** command values. It is the **USEREXPDATUM** command that appears in the **RXCONFIG** log (see page 732). If the **USEREXPDATUM** command or **USERDATUM** command are used, their newest values overwrite the internal **USEREXPDATUM** values.

The transformation for the WGS84 to Local used in the OEM7 family is the Bursa-Wolf transformation or reverse Helmert transformation. In the Helmert transformation, the rotation of a point is counter clockwise around the axes. In the Bursa-Wolf transformation, the rotation of a point is clockwise. Therefore, the reverse Helmert transformation is the same as the Bursa-Wolf.

**Message ID: 78**

#### **Abbreviated ASCII Syntax:**

```
USERDATUM semimajor flattening dx dy dz rx ry rz scale
```

#### **Factory Default:**

```
USERDATUM 6378137.0 298.2572235628 0.0 0.0 0.0 0.0 0.0 0.0 0.0
```

#### **ASCII Example:**

```
USERDATUM 6378206.400 294.97869820000 -12.0000 147.0000 192.0000 0.0000
0.0000 0.0000 0.0000000000
```



Use the **USERDATUM** command in a survey to fix the position with values from another known datum so that the GNSS calculated positions are reported in the known datum rather than WGS84.

| Field | Field Type       | ASCII Value              | Binary Value | Description  | Format | Binary Bytes | Binary Offset |
|-------|------------------|--------------------------|--------------|--|--------|--------------|---------------|
| 1     | USERDATUM header | -                        | -            | Command header. See <i>Messages</i> on page 25 for more information. | -      | H            | 0             |
| 2     | semimajor        | 6300000.0 -<br>6400000.0 |              | Datum Semi-major Axis (a) (metres)                                   | Double | 8            | H             |

| Field | Field Type | ASCII Value        | Binary Value | Description  | Format | Binary Bytes | Binary Offset |
|-------|------------|--------------------|--------------|--|--------|--------------|---------------|
| 3     | flattening | 290.0 - 305.0      |              | Reciprocal Flattening,<br>$1/f = a/(a-b)$  | Double | 8            | H+8           |
| 4     | dx         | $\pm 2000.0$       |              | Datum offsets from local to WGS84. These are the translation values between the user datum and WGS84 (internal reference) (metres)   | Double | 8            | H+16          |
| 5     | dy         | $\pm 2000.0$       |              |  | Double | 8            | H+24          |
| 6     | dz         | $\pm 2000.0$       |              |  | Double | 8            | H+32          |
| 7     | rx         | $\pm 10.0$ radians |              | Datum rotation angle about X, Y and Z. These values are the rotation from your local datum to WGS84. A positive sign is for counter clockwise rotation and a negative sign is for clockwise rotation | Double | 8            | H+40          |
| 8     | ry         | $\pm 10.0$ radians |              |  | Double | 8            | H+48          |
| 9     | rz         | $\pm 10.0$ radians |              |  | Double | 8            | H+56          |
| 10    | scale      | $\pm 10.0$ ppm     |              | Scale value is the difference in ppm between the user datum and WGS84  | Double | 8            | H+64          |

## 2.174 USEREXPDATUM

### *Set custom expanded datum*

**Platform:** OEM719, OEM729, OEM7500, OEM7700, OEM7720, PwrPak7, HxGN PIM7500

Like the **USERDATUM** command, this command allows you to enter customized ellipsoidal datum parameters. However, **USEREXPDATUM** literally means user expanded datum which allows additional datum information such as velocity offsets and time constraints. The 7 expanded parameters are rates of change of the initial 7 parameters. These rates of change affect the initial 7 parameters over time relative to the Reference Date provided by the user.

This command is used in conjunction with the **DATUM** command (see page 114). If this command is used without specifying any parameters, the command defaults to WGS84. If a **USERDATUM** command is entered, the **USEREXPDATUM** command is then issued internally with the **USERDATUM** command values (**USERDATUM** command on page 380). It is the **USEREXPDATUM** command that appears in the RXCONFIG log. If the **USEREXPDATUM** or the **USERDATUM** command are used, their newest values overwrite the internal **USEREXPDATUM** values.

**Message ID:** 783

#### Abbreviated ASCII Syntax:

```
USEREXPDATUM semimajor flattening dx dy dz rx ry rz scale xvel yvel zvel
xrvel yrvel zrvel scalev refdate
```

#### Factory Default:

```
USEREXPDATUM 6378137.0 298.25722356280 0.0 0.0 0.0 0.0 0.0 0.0 0.0 0.0 0.0 0.0
0.0 0.0 0.0 0.0 0.0 0.0
```

#### ASCII Example:

```
USEREXPDATUM 6378137.000 298.25722356280 0.000000000 0.000000000 0.000000000
0.000000000 0.000000000 0.000000000 0.000000000 0.000000000 0.000000000
0.000000000 0.0000 0.000000000 0.000000000 0.000000000 0.000000000
```



Use the **USEREXPDATUM** command in a survey to fix the position with values from another known datum so that the GPS calculated positions are reported in the known datum rather than WGS84. For example, it is useful for places like Australia, where the continent is moving several centimetres a year relative to WGS84. With **USEREXPDATUM** you can also input the velocity of the movement to account for drift over the years.

| Field | Field Type          | ASCII Value             | Binary Value | Description  | Format | Binary Bytes | Binary Offset |
|-------|---------------------|-------------------------|--------------|--|--------|--------------|---------------|
| 1     | USEREXPDATUM header | -                       | -            | Command header. See <i>Messages</i> on page 25 for more information.   | -      | H            | 0             |
| 2     | semimajor           | 6300000.0 - 6400000.0 m |              | Datum semi-major axis (a) in metres  | Double | 8            | H             |
| 3     | flattening          | 290.0 - 305.0           |              | Reciprocal Flattening, $1/f = a/(a-b)$   | Double | 8            | H+8           |
| 4     | dx                  | $\pm 2000.0$ m          |              | Datum offsets from local to WGS84. These are the translation values between the user datum and WGS84 (internal reference)  | Double | 8            | H+16          |
| 5     | dy                  | $\pm 2000.0$ m          |              |  | Double | 8            | H+24          |
| 6     | dz                  | $\pm 2000.0$ m          |              |  | Double | 8            | H+32          |
| 7     | rx                  | $\pm 10.0$ radians      |              | Datum rotation angle about X, Y and Z. These values are the rotation from your local datum to WGS84. A positive sign is for counter clockwise rotation and a negative sign is for clockwise rotation | Double | 8            | H+40          |
| 8     | ry                  | $\pm 10.0$ radians      |              |  | Double | 8            | H+48          |
| 9     | rz                  | $\pm 10.0$ radians      |              |  | Double | 8            | H+56          |
| 10    | scale               | $\pm 10.0$ ppm          |              | Scale value is the difference in ppm between the user datum and WGS84  | Double | 8            | H+64          |
| 11    | xvel                | $\pm 2000.0$ m/yr       |              | Velocity vector along X-axis   | Double | 8            | H+72          |
| 12    | yvel                | $\pm 2000.0$ m/yr       |              | Velocity vector along Y-axis   | Double | 8            | H+80          |
| 13    | zvel                | $\pm 2000.0$ m/yr       |              | Velocity vector along Z-axis   | Double | 8            | H+88          |
| 14    | xrvel               | $\pm 10.0$ radians/yr   |              | Change in the rotation about X over time   | Double | 8            | H+96          |
| 15    | yrvel               | $\pm 10.0$ radians/yr   |              | Change in the rotation about Y over time   | Double | 8            | H+104         |
| 16    | zrvel               | $\pm 10.0$ radians/yr   |              | Change in the rotation about Z over time   | Double | 8            | H+112         |

| Field | Field Type | ASCII Value   | Binary Value | Description   | Format | Binary Bytes | Binary Offset |
|-------|------------|---------------|--------------|---|--------|--------------|---------------|
| 17    | scalev     | ± 10.0 ppm/yr |              | Change in scale from WGS84 over time  | Double | 8            | H+120         |
| 18    | refdate    | 0.0 year      |              | Reference date of parameters<br>Example:<br>2011.00 = Jan 1, 2011<br>2011.19 = Mar 11, 2011 | Double | 8            | H+128         |



## 2.175 UTMZONE

### *Sets UTM parameters*

**Platform: OEM719, OEM729, OEM7500, OEM7700, OEM7720, PwrPak7, HxGN PIM7500**

This command sets the UTM persistence, zone number or meridian. Refer to [earth-info.nga.mil/GandG/coordsys/grids/referencesys.html](http://earth-info.nga.mil/GandG/coordsys/grids/referencesys.html) for more information and a world map of UTM zone numbers.



1. The latitude limits of the UTM System are 80°S to 84°N, so if your position is outside this range, the **BESTUTM** log (see page 429) outputs a northing, easting and height of 0.0, along with a zone letter of "\*" and a zone number of 0, so that it is obvious that the data in the log is dummy data.
2. If the latitude band is X, then the Zone number should not be set to 32, 34 or 36. These zones were incorporated into other zone numbers and do not exist.

**Message ID: 749**

#### **Abbreviated ASCII Syntax:**

```
UTMZONE command [parameter]
```

#### **Factory Default:**

```
UTMZONE auto 0
```

#### **ASCII Example 1:**

```
UTMZONE SET 10
```

#### **ASCII Example 2:**

```
UTMZONE CURRENT
```



The UTM grid system is displayed on all National Topographic Series (NTS) of Canada maps and United States Geological Survey (USGS) maps. On USGS 7.5-minute quadrangle maps (1:24,000 scale), 15-minute quadrangle maps (1:50,000, 1:62,500, and standard-edition 1:63,360 scales) and Canadian 1:50,000 maps the UTM grid lines are drawn at intervals of 1,000 metres and are shown either with blue ticks at the edge of the map or by full blue grid lines. On USGS maps at 1:100,000 and 1:250,000 scale and Canadian 1:250,000 scale maps a full UTM grid is shown at intervals of 10,000 metres.

| Field | Field Type     | ASCII Value                                  | Binary Value | Description  | Format | Binary Bytes | Binary Offset |
|-------|----------------|--|--------------|--|--------|--------------|---------------|
| 1     | UTMZONE header | -  | -            | Command header. See <i>Messages</i> on page 25 for more information. | -      | H            | 0             |
| 2     | command        | See <i>Table 69: UTM Zone Commands</i> below |              |  | Enum   | 4            | H             |
| 3     | parameter      | See <i>Table 69: UTM Zone Commands</i> below |              |  | Long   | 4            | H+4           |

**Table 69: UTM Zone Commands**

| Binary | ASCII    | Description  |
|--------|----------|--|
| 0      | AUTO     | UTM zone default that automatically sets the central meridian and does not switch zones until it overlaps by the set persistence. This a spherical approximation to the earth unless you are at the equator (default = 0) (m)              |
| 1      | CURRENT  | Same as UTMZONE AUTO with infinite persistence of the current zone. The parameter field is not used  |
| 2      | SET      | Sets the central meridian based on the specified UTM zone. A zone includes its western boundary, but not its eastern boundary, Meridian. For example, zone 12 includes (108°W, 114°W) where 108° < longitude < 114°                        |
| 3      | MERIDIAN | Sets the central meridian as specified in the parameter field. In the <b>BESTUTM</b> log (see page 429), the zone number is output as 61 to indicate the manual setting (zones are set by pre-defined central meridians not user-set ones) |

## 2.176 WIFIAPCHANNEL

### *Set the channel for the Wi-Fi access point*

**Platform: PwrPak7**

Use this command to set the operating channel for the Wi-Fi module when operating as an access point. The new channel will be used the next time the **WIFIMODE AP** command is received.

**Message ID: 2091**

**Abbreviated ASCII Syntax:**

```
WIFIAPCHANNEL channel
```

**Factory Default:**

```
WIFIAPCHANNEL 11
```

**Example:**

```
WIFIAPCHANNEL 6
```

| Field | Field Type           | ASCII Value | Binary Value | Description  | Format | Binary Value | Binary Offset |
|-------|----------------------|-------------|--------------|--|--------|--------------|---------------|
| 1     | WIFIAPCHANNEL header | -           | -            | Command header. See <i>Messages</i> on page 25 for more information. | -      | H            | 0             |
| 2     | channel              | 1-14        |              | 802.11 channel   | Long   | 4            | H             |



For best performance, choose one of the non-overlapping channels: 1, 6, or 11.

## 2.177 WIFIAPIPCONFIG

***Set the IP address and netmask for the Wi-Fi access point***

**Platform: PwrPak7**

Use this command to set the Wi-Fi IP address and netmask for Wi-Fi module when operating as an access point. The new network configuration takes effect the next time the **WIFIMODE AP** command is received.

**Message ID: 2096**

**Abbreviated ASCII Syntax:**

```
WIFIAPIPCONFIG ip_address ip_netmask
```

**Factory Default:**

```
WIFIAPIPCONFIG 192.168.19.1 255.255.255.0
```

**Example:**

```
WIFIAPIPCONFIG 192.162.55.20 255.255.0.0
```

| Field | Field Type            | ASCII Value                  | Binary Value | Description  | Format      | Binary Bytes | Binary Offset |
|-------|-----------------------|------------------------------|--------------|--|-------------|--------------|---------------|
| 1     | WIFIAPIPCONFIG header | -                            | -            | Command header. See <i>Messages</i> on page 25 for more information. | -           | H            | 0             |
| 2     | ip_address            | Null-terminated ASCII string |              | IP address, dot decimal format                                       | String [16] | Variable     | H             |
| 3     | ip_netmask            | Null-terminated ASCII string |              | IP netmask, dot decimal format (optional)<br>Default =255.255.255.0  | String [16] | Variable     | Variable      |

## 2.178 WIFIAPPASSKEY

### *Set Wi-Fi passkey*

#### **Platform: PwrPak7**

Use this command to set the WPA2 PSK ASCII passkey for the Wi-Fi module when the receiver is operating as an access point.

The default passkey is printed on the receiver label.

The new passkey takes effect the next time the **WIFIMODE AP** command is received.

#### **Message ID: 2090**

#### **Abbreviated ASCII Syntax:**

```
WIFIAPPASSKEY passkey
```

#### **Factory Default:**

The default passkey is printed on the receiver label.

#### **Example:**

```
WIFIAPPASSKEY "bysP3zE6SZmFQeyd"
```

| Field | Field Type           | ASCII Value                                      | Binary Value | Description  | Format      | Binary Bytes | Binary Offset |
|-------|----------------------|--|--------------|--|-------------|--------------|---------------|
| 1     | WIFIAPPASSKEY header | -  | -            | Command header. See <i>Messages</i> on page 25 for more information. | -           | H            | 0             |
| 2     | passkey              | Null-terminated ASCII string, 8 to 64 characters |              | WPA2 PSK ASCII passkey   | String [65] | Variable     | H             |

## 2.179 WIFIMODE

### *Configure the receiver Wi-Fi mode*

**Platform:** PwrPak7

Use this command to enable or disable Wi-Fi on the receiver.

**Message ID:** 2144

**Abbreviated ASCII Syntax:**

```
WIFIMODE mode
```

**Factory Default:**

```
WIFIMODE AP
```

**Example:**

```
WIFIMODE OFF
```

| Field | Field Type      | ASCII Value | Binary Value | Description  | Format | Binary Bytes | Binary Offset |
|-------|-----------------|-------------|--------------|--|--------|--------------|---------------|
| 1     | WIFIMODE header | -           | -            | Command header. See <i>Messages</i> on page 25 for more information. | -      | H            | 0             |
| 2     | mode            | OFF         | 0            | Power off the Wi-Fi module   | Enum   | 4            | H             |
|       |                 | AP          | 1            | Configure the Wi-Fi module as an Access Point (AP)                   |        |              |               |
|       |                 | ON          | 3            | Supply power to the Wi-Fi module, but do not configure it.           |        |              |               |

# Chapter 3 Logs

## 3.1 Log Types

See the **LOG** command on page 216, for details about requesting logs.

The receiver is capable of generating three type of logs: synchronous, asynchronous and polled. The data for synchronous logs is generated on a regular schedule. In order to output the most current data as soon as it is available, asynchronous data is generated at irregular intervals. The data in polled logs is generated on demand. The following table outlines the log types and the valid triggers to use:

**Table 70: Log Type Triggers**

| Type   | Recommended Trigger         | Illegal Trigger  |
|--------|-----------------------------|------------------|
| Synch  | ONTIME                      | ONNEW, ONCHANGED |
| Asynch | ONCHANGED or ONCE           | -                |
| Polled | ONCE or ONTIME <sup>a</sup> | ONNEW, ONCHANGED |

See *Message Time Stamps* on page 48 for information about how the message time stamp is set for each type of log.



1. The OEM7 family of receivers can handle 80 logs at a time. If an attempt is made to log more than 80 logs at a time, the receiver responds with an Insufficient Resources error.
2. Asynchronous logs, such as MATCHEDPOS, should only be logged ONCHANGED. Otherwise, the most current data is not output when it is available. This is especially true of the ONTIME trigger, which may result in inaccurate time tags.
3. Use the ONNEW trigger with the MARKTIME or MARKPOS logs.
4. Before the output of fields for ASCII and binary logs, there is an ASCII or binary header respectively. See *Table 2: ASCII Message Header Structure* on page 28 and *Table 3: Binary Message Header Structure* on page 30. There is no header information before Abbreviated ASCII output, see *Abbreviated ASCII* on page 29.

### 3.1.1 Log Type Examples

For polled logs, the receiver only supports an offset that is:

- smaller than the logging period
- decimal values that are a multiple of the maximum logging rate defined by the receiver model. For more information see the **LOG** command on page 216.

The following are valid examples for a polled log:

```
log portstats ontime 4 2
```

<sup>a</sup>Polled log types do not allow fractional offsets and cannot do ontime rates faster than 1 Hz.

```
log version once
```

For polled logs, the following examples are invalid:

```
log serialconfig ontime 1 2      [offset is larger than the logging period]
```

```
log serialconfig ontime 4 1.5    [offset is not an integer]
```

For synchronous and asynchronous logs, the receiver supports any offset that is:

- smaller than the logging period
- a multiple of the minimum logging period

For example, if the receiver supports 20 Hz logging, the minimum logging period is 1/20 Hz or 0.05 s. The following are valid examples for a synchronous or asynchronous log, on a receiver that can log at rates up to 20 Hz:

```
log bestpos ontime 1             [1 Hz]
```

```
log bestpos ontime 1 0.1
```

```
log bestpos ontime 1 0.90
```

```
log avepos ontime 1 0.95
```

```
log avepos ontime 2             [0.5 Hz]
```

```
log avepos ontime 2 1.35
```

```
log avepos ontime 2 1.75
```

For synchronous and asynchronous logs, the following examples are invalid:

```
log bestpos ontime 1 0.08      [offset is not a multiple of the minimum logging period]
```

```
log bestpos ontime 1 1.05      [offset is larger than the logging period]
```

## 3.2 Log Reference

Logs are the mechanism used to extract information from the receiver.



### 3.3 ALIGNBSLNENU

#### *ENU baselines using ALIGN*

**Platform: OEM719, OEM729, OEM7500, OEM7700, OEM7720, PwrPak7, HxGN PIM7500**

This log outputs the RTK quality ENU baselines from ALIGN. The XYZ baselines (output in ALIGNBSLNXYZ log) are rotated relative to master position (output in MASTERPOS) to compute ENU baselines.



On dual antenna receivers, the ALIGNBSLNENU log is not available for the secondary antenna input.

**Message ID: 1315**

**Log Type: Asynch**

**Recommended Input:**

```
log alignbslnenua onnew
```

**ASCII Example:**

```
#ALIGNBSLNENUA,COM1,0,29.0,FINESTEERING,1629,259250.000,02040000,100b,
39448;SOL_COMPUTED,NARROW_INT,4.1586,-1.9197,-
0.0037,0.0047,0.0050,0.0062,"0092","AAAA",22,16,16,16,0,01,0,33*11e1d4
c0
```

| Field | Field type    | Description   | Format | Binary Bytes | Binary Offset |
|-------|---------------|---|--------|--------------|---------------|
| 1     | ALIGNBSLNENU  | Log header. See <i>Messages</i> on page 25 for more information.          |        | H            | 0             |
| 2     | sol stat      | Solution status, see <i>Table 73: Solution Status</i> on page 419         | Enum   | 4            | H             |
| 3     | pos type      | Position type, see <i>Table 74: Position or Velocity Type</i> on page 420 | Enum   | 4            | H+4           |
| 4     | East          | East Baseline (relative to master position) in metres                     | Double | 8            | H+8           |
| 5     | North         | North Baseline (relative to master position) in metres                    | Double | 8            | H+16          |
| 6     | Up            | Up Baseline (relative to master position) in metres                       | Double | 8            | H+24          |
| 7     | East $\sigma$ | East Baseline standard deviation in metres                                | Float  | 4            | H+32          |

| Field | Field type                  | Description   | Format  | Binary Bytes | Binary Offset |
|-------|-----------------------------|---|---------|--------------|---------------|
| 8     | North $\sigma$              | North Baseline standard deviation in metres   | Float   | 4            | H+36          |
| 9     | Up $\sigma$                 | Up Baseline standard deviation in metres  | Float   | 4            | H+40          |
| 10    | Rover id                    | Rover Receiver ID<br>Set using the <b>SETROVERID</b> command (see page 343) on the Rover<br>e.g., setroverid RRRR | Char[4] | 4            | H+44          |
| 11    | Master id                   | Master Receiver ID<br>Set using the <b>DGPSTXID</b> command (see page 121) on the Master<br>Default: AAAA         | Char[4] | 4            | H+48          |
| 12    | #SVs                        | Number of satellites tracked  | Uchar   | 1            | H+52          |
| 13    | #solnSVs                    | Number of satellites in solution  | Uchar   | 1            | H+53          |
| 14    | #obs                        | Number of satellites above elevation mask angle   | Uchar   | 1            | H+54          |
| 15    | #multi                      | Number of satellites above elevation mask angle with L2, B2   | Uchar   | 1            | H+55          |
| 16    | Reserved                    |   | Hex     | 1            | H+56          |
| 17    | ext sol stat                | Extended solution status, see <i>Table 77: Extended Solution Status</i> on page 423                               | Hex     | 1            | H+57          |
| 18    | Galileo and BeiDou sig mask | Galileo and BeiDou signals used mask (see <i>Table 76: Galileo and BeiDou Signal-Used Mask</i> on page 423)       | Hex     | 1            | H+58          |
| 19    | GPS and GLONASS sig mask    | GPS and GLONASS signals used mask (see <i>Table 75: GPS and GLONASS Signal-Used Mask</i> on page 422)             | Hex     | 1            | H+59          |
| 20    | xxxx                        | 32-bit CRC (ASCII and Binary only)  | Hex     | 4            | H+60          |
| 21    | [CR][LF]                    | Sentence Terminator (ASCII only)  | -       | -            | -             |

## 3.4 ALIGNBSLNXYZ

### *XYZ baselines using ALIGN*

**Platform: OEM719, OEM729, OEM7500, OEM7700, OEM7720, PwrPak7, HxGN PIM7500**

This log outputs the RTK quality XYZ baselines from ALIGN.



On dual antenna receivers, the ALIGNBSLNXYZ log is not available for the secondary antenna input.

**Message ID: 1314**

**Log Type: Asynch**

**Recommended Input:**

```
log alignbslnxyza onnew
```

**ASCII Example:**

```
#ALIGNBSLNXYZA, COM1, 0, 29.0, FINESTEERING, 1629, 259250.000, 02040000, 9d28,
39448; SOL_COMPUTED, NARROW_INT, 3.1901, -
3.0566, 1.2079, 0.0050, 0.0054, 0.0056, "0092", "AAAA", 22, 16, 16, 16, 0, 01, 0, 33
*ac372198
```

| Field | Field type   | Description   | Format | Binary Bytes | Binary Offset |
|-------|--------------|---|--------|--------------|---------------|
| 1     | ALIGNBSLNXYZ | Log header. See <i>Messages</i> on page 25 for more information.          |        | H            | 0             |
| 2     | sol stat     | Solution status, see <i>Table 73: Solution Status</i> on page 419         | Enum   | 4            | H             |
| 3     | pos type     | Position type, see <i>Table 74: Position or Velocity Type</i> on page 420 | Enum   | 4            | H+4           |
| 4     | dX           | X Baseline in metres  | Double | 8            | H+8           |
| 5     | dY           | Y Baseline in metres  | Double | 8            | H+16          |
| 6     | dZ           | Z Baseline in metres  | Double | 8            | H+24          |
| 7     | dX $\sigma$  | X Baseline standard deviation in metres                                   | Float  | 4            | H+32          |
| 8     | dY $\sigma$  | Y Baseline standard deviation in metres                                   | Float  | 4            | H+36          |
| 9     | dZ $\sigma$  | Z Baseline standard deviation in metres                                   | Float  | 4            | H+40          |

| Field | Field type                  | Description  | Format       | Binary Bytes | Binary Offset |
|-------|-----------------------------|--|--------------|--------------|---------------|
| 10    | Rover id                    | Rover Receiver ID<br>Set using <b>SETROVERID</b> command (see page 343) on the Rover<br>e.g. SETROVERID RRRR | Uchar<br>[4] | 4            | H+44          |
| 11    | Master id                   | Master Receiver Id<br>Set using the <b>DGPSTXID</b> command (see page 121) on the Master<br>Default: AAAA    | Uchar<br>[4] | 4            | H+48          |
| 12    | #SVs                        | Number of satellites tracked   | Uchar        | 1            | H+52          |
| 13    | #solnSVs                    | Number of satellites in solution   | Uchar        | 1            | H+53          |
| 14    | #obs                        | Number of satellites above elevation mask angle  | Uchar        | 1            | H+54          |
| 15    | #multi                      | Number of satellites above elevation mask angle with L2, B2  | Uchar        | 1            | H+55          |
| 16    | Reserved                    |  | Hex          | 1            | H+56          |
| 17    | ext sol stat                | Extended solution status, see <i>Table 77: Extended Solution Status</i> on page 423                          | Hex          | 1            | H+57          |
| 18    | Galileo and BeiDou sig mask | Galileo and BeiDou signals used mask (see <i>Table 76: Galileo and BeiDou Signal-Used Mask</i> on page 423)  | Hex          | 1            | H+58          |
| 19    | GPS and GLONASS sig mask    | GPS and GLONASS signals used mask (see <i>Table 75: GPS and GLONASS Signal-Used Mask</i> on page 422)        | Hex          | 1            | H+59          |
| 20    | xxxx                        | 32-bit CRC (ASCII and Binary only)   | Hex          | 4            | H+60          |
| 21    | [CR][LF]                    | Sentence Terminator (ASCII only)   | -            | -            | -             |

## 3.5 ALIGNDOP

### *Calculated DOP values*

**Platform: OEM719, OEM729, OEM7500, OEM7700, OEM7720, PwrPak7, HxGN PIM7500**

This log outputs the DOP computed using the satellites used in the heading solution. This log comes out at a default 1 Hz rate. Additional logs may be output not on the even second if the DOP changes and ALIGN is operating at greater than 1 Hz.

**Message ID: 1332**

**Log Type: Asynch**

**Recommended Input:**

```
log aligndopa onnew
```

**ASCII Example:**

```
#ALIGNDOPA,COM1,0,22.5,FINESTEERING,1629,259250.000,02040000,de2d,3944
8;1.6160,1.2400,0.6900,0.9920,0.7130,10.0,16,4,32,23,10,7,20,13,30,16,
47,43,46,53,54,44,45*90a72971
```

| Field | Field type                         | Description  | Format | Binary Bytes | Binary Offset        |
|-------|------------------------------------|--|--------|--------------|----------------------|
| 1     | ALIGNDOP                           | Log header. See <i>Messages</i> on page 25 for more information. |        | H            | 0                    |
| 2     | GDOP                               | Geometric DOP  | Float  | 4            | H                    |
| 3     | PDOP                               | Position DOP   | Float  | 4            | H+4                  |
| 4     | HDOP                               | Horizontal DOP   | Float  | 4            | H+8                  |
| 5     | HTDOP                              | Horizontal and time DOP  | Float  | 4            | H+12                 |
| 6     | TDOP                               | Time DOP   | Float  | 4            | H+16                 |
| 7     | Elev mask                          | Elevation mask angle   | Float  | 4            | H+20                 |
| 8     | #sats                              | Number of satellites to follow                                   | Ulong  | 4            | H+24                 |
| 9     | sats                               | Satellites in use at time of calculation                         | Ulong  | 4            | H+28                 |
| 10    | Next sat offset = H+28+(#sats * 4) |  |        |              |                      |
| 11    | xxxx                               | 32-bit CRC (ASCII and Binary only)                               | Hex    | 4            | H+28+<br>(#sats * 4) |
| 12    | [CR][LF]                           | Sentence terminator (ASCII only)                                 | -      | -            | -                    |

## 3.6 ALMANAC

### *Decoded GPS Almanac*

**Platform: OEM719, OEM729, OEM7500, OEM7700, OEM7720, PwrPak7, HxGN PIM7500**

This log contains the decoded GPS almanac parameters from subframes four and five, as received from the satellite, with the parity information removed and appropriate scaling applied. For more information about almanac data, refer to the GPS SPS Signal Specification.

The OEM7 family of receivers automatically save almanacs in their Non-Volatile Memory (NVM), so creating an almanac boot file is not necessary.

**Message ID: 73**

**Log Type: Asynch**

**Recommended Input:**

```
log almanaca onchanged
```

**ASCII Example:**

```
#ALMANACA, COM1, 0, 54.0, SATTIME, 1364, 409278.000, 02000000, 06de, 2310;
29,
1, 1364, 589824.0, 6.289482e-03, -7.55460039e-09, -2.2193421e+00, -
1.70647776e+00, -7.94268362e-01, 4.00543213e-05, 3.63797881e-
12, 1.45856541e-04, 2.6560037e+07, 4.45154034e-02, 1, 0, 0, FALSE,
2, 1364, 589824.0, 9.173393e-03, -8.16033991e-
09, 1.9308788e+00, 1.9904300e+00, 6.60915023e-01, -1.62124634e-
05, 0.00000000, 1.45860023e-04, 2.6559614e+07, 8.38895743e-03, 1, 0, 0, FALSE,
3, 1364, 589824.0, 7.894993e-03, -8.04604944e-09, 7.95206128e-
01, 6.63875501e-01, -2.00526792e-01, 7.91549683e-05, 3.63797881e-
12, 1.45858655e-04, 2.6559780e+07, -1.59210428e-02, 1, 0, 0, TRUE,
...
28, 1364, 589824.0, 1.113367e-02, -7.87461372e-09, -1.44364969e-01, -
2.2781989e+00, 1.6546425e+00, 3.24249268e-05, 0.00000000, 1.45859775e-
04, 2.6559644e+07, 1.80122900e-02, 1, 0, 0, FALSE,
29, 1364, 589824.0, 9.435177e-03, -7.57745849e-09, -2.2673888e+00, -
9.56729511e-01, 1.1791713e+00, 5.51223755e-04, 1.09139364e-11, 1.45855297e-
04, 2.6560188e+07, 4.36225787e-02, 1, 0, 0, FALSE,
30, 1364, 589824.0, 8.776665e-03, -8.09176563e-09, -1.97082451e-
01, 1.2960786e+00, 2.0072936e+00, 2.76565552e-05, 0.00000000, 1.45849410e-
04, 2.6560903e+07, 2.14517626e-03, 1, 0, 0, FALSE*de7a4e45
```



The speed at which the receiver locates and locks onto new satellites is improved if the receiver has approximate time and position, as well as an almanac. This allows the receiver to compute the elevation of each satellite so it can tell which satellites are visible and their Doppler offsets, improving Time to First Fix (TTFF).

| Field | Field type     | Description   | Format | Binary Bytes | Binary Offset |
|-------|----------------|---|--------|--------------|---------------|
| 1     | ALMANAC        | Log header. See <i>Messages</i> on page 25 for more information.                                    |        | H            | 0             |
| 2     | #messages      | The number of satellite PRN almanac messages to follow. Set to zero until almanac data is available | Long   | 4            | H             |
| 3     | PRN            | Satellite PRN number for current message (dimensionless)  | Ulong  | 4            | H+4           |
| 4     | week           | Almanac reference week (GPS reference week number)  | Ulong  | 4            | H+8           |
| 5     | seconds        | Almanac reference time (seconds into the week)  | Double | 8            | H+12          |
| 6     | ecc            | Eccentricity (dimensionless)  | Double | 8            | H+20          |
| 7     | $\dot{\omega}$ | Rate of right ascension (radians/second)  | Double | 8            | H+28          |
| 8     | $\omega_0$     | Right ascension (radians)   | Double | 8            | H+36          |
| 9     | $\omega$       | Argument of perigee (radians)   | Double | 8            | H+44          |
| 10    | $M_0$          | Mean anomaly of reference time (radians)  | Double | 8            | H+52          |
| 11    | $a_{f0}$       | Clock aging parameter (seconds)   | Double | 8            | H+60          |
| 12    | $a_{f1}$       | Clock aging parameter (seconds/second)  | Double | 8            | H+68          |
| 13    | $N_0$          | Computed mean motion (radians/second)   | Double | 8            | H+76          |
| 14    | A              | Semi-major axis (metres)  | Double | 8            | H+84          |
| 15    | incl-angle     | Angle of inclination relative to $0.3 \pi$ (radians)  | Double | 8            | H+92          |
| 16    | SV config      | Satellite configuration   | Ulong  | 4            | H+100         |
| 17    | health-prn     | SV health from Page 25 of subframe 4 or 5 (6 bits)  | Ulong  | 4            | H+104         |
| 18    | health-alm     | SV health from almanac (8 bits)   | Ulong  | 4            | H+108         |

| Field | Field type                                  | Description                                | Format | Binary Bytes | Binary Offset                   |
|-------|---|--|--------|--------------|---------------------------------|
| 19    | antispoof                                   | Anti-spoofing on?<br>0 = FALSE<br>1 = TRUE | Bool   | 4            | H+112                           |
| 20... | Next PRN offset = H + 4 + (#messages x 112) |  |        |              |                                 |
| 21    | xxxx  | 32-bit CRC (ASCII and Binary only)         | Hex    | 4            | H + 4 +<br>(112 x<br>#messages) |
| 22    | [CR][LF]                                    | Sentence terminator (ASCII only)           | -      | -            | -                               |



## 3.7 AUTHCODES

### *List of authorization codes*

**Platform: OEM719, OEM729, OEM7500, OEM7700, OEM7720, PwrPak7, HxGN PIM7500**

This log contains all authorization codes (auth codes) entered into the system since the last complete firmware reload. Signature authorization codes will be maintained through a SoftLoad. The log also indicates the status of the firmware signature. For more information about firmware signatures see the "Upgrading Using the AUTH Command" section of the [OEM7 Installation and Operation User Manual](#).



The following situations will cause an authorization code to be marked invalid:

- Authorization Code is for a different receiver
- Authorization Code has expired
- Authorization Code was entered incorrectly

If you require new authorization codes, contact NovAtel Customer Service.

**Message ID: 1348**

**Log Type: Polled**

**Recommended Input:**

```
log authcodesa once
```

**ASCII Example:**

```
#AUTHCODESA,COM1,0,80.5,UNKNOWN,0,10.775,024c0000,2ad2,12143;VALID,2,SIGNATURE,TRUE,"63F3K8,MX43GD,T4BJ2X,924RRB,BZRWB,T,D2SB0G550",STANDARD,TRUE,"CJ43M9,2RNDBH,F3PDK8,N88F44,8JMKK9,D2SB0G550"*6f778e32
```

| Field | Field type                 | Description  | Format | Binary Bytes | Binary Offset |
|-------|----------------------------|--|--------|--------------|---------------|
| 1     | AUTHCODES header           | Log header. See <i>Messages</i> on page 25 for more information.   |        | H            | 0             |
| 2     | AUTHCODES Signature Status | Status of the Firmware Signature<br>1 = NONE<br>2 = INVALID<br>3 = VALID<br>4 = RESERVED<br>5 = HIGH_SPEED | Enum   | 4            | H             |

| Field | Field type                                 | Description                             | Format          | Binary Bytes          | Binary Offset              |
|-------|--|---|-----------------|-----------------------|----------------------------|
| 3     | Number of Auth Codes                       | # of Auth Codes to follow (max is 24)   | Ulong           | 4                     | H+4                        |
| 4     | Auth code type                             | 1=STANDARD<br>2=SIGNATURE<br>3=EMBEDDED | Enum            | 4                     | H+8                        |
| 5     | Valid                                      | TRUE if the Auth Code has been verified | Bool            | 4                     | H+12                       |
| 6     | Auth Code String                           | ASCII String of the Auth Code           | String [max 80] | variable <sup>1</sup> | H+16                       |
| 7...  | Next AuthCode = H+8+ (#AuthCodes*variable) |   |                 |                       |                            |
| 8     | xxxx                                       | 32-bit CRC (ASCII and Binary only)      | Hex             | 4                     | H+8+ (#AuthCodes*variable) |
| 9     | [CR][LF]                                   | Sentence terminator (ASCII only)        | -               | -                     | -                          |

<sup>1</sup>In the binary case, each string field needs to be NULL terminated and additional bytes of padding added to maintain 4-byte alignment, up to the maximum defined by the string size. The next defined field starts immediately at the next 4-byte alignment following the NULL.

## 3.8 AVEPOS

### *Position averaging*

**Platform: OEM719, OEM729, OEM7500, OEM7700, OEM7720, PwrPak7, HxGN PIM7500**

When position averaging is underway, the various fields in the AVEPOS log contain the parameters being used in the position averaging process. *Table 71: Position Averaging Status* on page 405 shows the possible position averaging status values seen in field #8 of the AVEPOS log table.

See the description of the **POSAVE** command on page 253. For general positioning information, refer to [An Introduction to GNSS](#) available on our website.



Asynchronous logs should only be logged ONCHANGED. Otherwise, the most current data is not output when it is available. This is especially true of the ONTIME trigger, which may cause inaccurate time tags to result.

**Message ID: 172**

**Log Type: Asynch**

**Recommended Input:**

```
log aveposa onchanged
```

**ASCII Example:**

```
#AVEPOSA, COM1, 0, 48.5, FINESTEERING, 1364, 492100.000, 82000000, e3b4, 2310; 5
1.11635589900, -
114.03833558937, 1062.216134356, 1.7561, 0.7856, 1.7236, INPROGRESS, 2400, 2*
72a550c1
```



When a GNSS position is computed, there are four unknowns being solved: latitude, longitude, height and receiver clock offset (often just called time). The solutions for each of the four unknowns are correlated to satellite positions in a complex way. Since satellites are above the antenna (none are below) there is a geometric bias. Therefore, geometric biases are present in the solutions and affect the computation of height. These biases are called DOPs (Dilution Of Precision). Smaller biases are indicated by low DOP values. VDOP (Vertical DOP) pertains to height. Most of the time, VDOP is higher than HDOP (Horizontal DOP) and TDOP (Time DOP). Therefore, of the four unknowns, height is the most difficult to solve. Many GNSS receivers output the Standard Deviations (SD) of the latitude, longitude and height. Height often has a larger value than the other two.

Accuracy is based on statistics and reliability is measured in percent. When a receiver states it can measure height to one metre, this is an accuracy. Usually this is a one sigma value (one SD). A one sigma value for height has a reliability of 68%. In other words, the error is less than one metre 68% of the time. For a more realistic accuracy, double the one sigma value (one metre) and the result is 95% reliability (error is less than two metres 95% of the time). Generally, GNSS heights are 1.5 times poorer than horizontal positions. See also **GPGST** log on page 508 for CEP and RMS definitions.

| Field | Field type    | Description   | Format | Binary Bytes | Binary Offset |
|-------|---------------|---|--------|--------------|---------------|
| 1     | AVEPOS header | Log header. See <i>Messages</i> on page 25 for more information.                            |        | H            | 0             |
| 2     | lat           | Average WGS84 latitude (degrees)  | Double | 8            | H             |
| 3     | lon           | Average WGS84 longitude (degrees)   | Double | 8            | H+8           |
| 4     | hgt           | Average height above sea level (m)  | Double | 8            | H+16          |
| 5     | lat $\sigma$  | Estimated average standard deviation of latitude solution element (m)                       | Float  | 4            | H+24          |
| 6     | lon $\sigma$  | Estimated average standard deviation of longitude solution element (m)                      | Float  | 4            | H+28          |
| 7     | hgt $\sigma$  | Estimated average standard deviation of height solution element (m)                         | Float  | 4            | H+32          |
| 8     | posave        | Position averaging status (see <i>Table 71: Position Averaging Status</i> on the next page) | Enum   | 4            | H+36          |
| 9     | ave time      | Elapsed time of averaging (s)   | Ulong  | 4            | H+40          |
| 10    | #samples      | Number of samples in the average  | Ulong  | 4            | H+44          |
| 11    | xxxx          | 32-bit CRC (ASCII and Binary only)  | Hex    | 4            | H+48          |
| 12    | [CR][LF]      | Sentence terminator (ASCII only)  | -      | -            | -             |

**Table 71: Position Averaging Status**

| <b>Binary</b> | <b>ASCII</b> | <b>Description</b>        |
|---------------|--------------|---------------------------|
| 0             | OFF          | Receiver is not averaging |
| 1             | INPROGRESS   | Averaging is in progress  |
| 2             | COMPLETE     | Averaging is complete     |

## 3.9 BDSALMANAC

### *Decoded BDS Almanac*

**Platform: OEM719, OEM729, OEM7500, OEM7700, OEM7720, PwrPak7, HxGN PIM7500**

This log contains the decoded BeiDou almanac parameters, with the parity information removed and appropriate scaling applied. Multiple messages are transmitted, one for each SV almanac collected. For more information about almanac data, refer to the BDS Signal Specification.

The OEM7 family of receivers automatically save almanacs in their Non-Volatile Memory (NVM), so creating an almanac boot file is not necessary.

**Message ID: 1584**

**Log Type: Asynch**

**Recommended Input:**

```
log bdsalmanaca onchanged
```

**ASCII Example:**

```
#BDSALMANACA,COM1,13,88.5,SATTIME,1727,518438.000,02000000,24ad,44226;1
1,371,245760,6493.394531,2.9134750366e-04,-2.289514637,-0.021819903,-
2.456844003,1.30291141e-09,2.7785425443e-02,-1.096725e-04,2.18279e-
11,0*77017e1b
```

...

```
#BDSALMANACA,COM1,0,88.5,SATTIME,1727,518108.000,02000000,24ad,44226;1
4,371,217088,5282.558105,1.4486312866e-03,-
2.970093901,2.846651891,1.512957087,-6.91457373e-09,1.7820542434e-
02,7.438660e-05,0.00000,d8*ce944672
```



The speed at which the receiver locates and locks onto new satellites is improved if the receiver has approximate time and position, as well as an almanac. This allows the receiver to compute the elevation of each satellite so it can tell which satellites are visible and their Doppler offsets, improving Time to First Fix (TTFF).

| Field | Field Type        | Description  | Format | Binary Bytes | Binary Offset |
|-------|-------------------|--|--------|--------------|---------------|
| 1     | BDSALMANAC header | Log header. See <i>Messages</i> on page 25 for more information. |        | H            | 0             |
| 2     | satellite ID      | Satellite ID/ranging code  | Ulong  | 4            | H             |
| 3     | week              | Week number  | Ulong  | 4            | H+4           |
| 4     | toa               | Time of almanac (seconds)  | Ulong  | 4            | H+8           |

| Field | Field Type     | Description  | Format | Binary Bytes | Binary Offset |
|-------|----------------|--|--------|--------------|---------------|
| 5     | RootA          | Square root of semi-major axis (sqrt (metres))   | Double | 8            | H+12          |
| 6     | ecc            | Eccentricity (dimensionless)   | Double | 8            | H+20          |
| 7     | $\omega$       | Argument of perigee (radians)  | Double | 8            | H+28          |
| 8     | $M_0$          | Mean anomaly at reference time (radians)   | Double | 8            | H+36          |
| 9     | $\Omega$       | Longitude of ascending node of orbital of plane computed according to reference time (radians) | Double | 8            | H+44          |
| 10    | $\dot{\Omega}$ | Rate of right ascension (radians/second)   | Double | 8            | H+52          |
| 11    | $\delta_i$     | Correction of orbit reference inclination at reference time (radians)                          | Double | 8            | H+60          |
| 12    | $a_0$          | Constant term of clock correction polynomial (seconds)   | Double | 8            | H+68          |
| 13    | $a_1$          | Linear term of clock correction polynomial (seconds/seconds)                                   | Double | 8            | H+76          |
| 14    | health         | Satellite health information   | Ulong  | 4            | H+84          |
| 15    | xxxx           | 32-bit CRC (ASCII and Binary only)   | Hex    | 4            | H+88          |
| 16    | [CR][LF]       | Sentence terminator (ASCII only)   | -      | -            | -             |

## 3.10 BDSCLOCK

### *BeiDou time parameters*

**Platform: OEM719, OEM729, OEM7500, OEM7700, OEM7720, PwrPak7, HxGN PIM7500**

This log contains time parameters transmitted by the BeiDou satellites. These parameters can be used to calculate the offset between BeiDou time (BDT) and other time frames.

**Message ID: 1607**

**Log Type: Asynch**

**Recommended Input:**

```
log bdscllocka onchanged
```

**ASCII Example:**

```
#BDSCLOCKA,COM1,0,80.0,SATTIME,1730,193994.000,02000000,3b16,44290;
-9.313225746154785e-010,-8.881784197001252e-016,2,6,0,2,
0.0000000000000000e+000,0.0000000000000000e+000,0.0000000000000000e+000,
0.0000000000000000e+000,0.0000000000000000e+000,0.0000000000000000e+000
*84820676
```

| Field | Field Type        | Description  | Format | Binary Bytes | Binary Offset |
|-------|-------------------|--|--------|--------------|---------------|
| 1     | BDSCLOCK header   | Log header. See <i>Messages</i> on page 25 for more information.                 |        | H            | 0             |
| 2     | A <sub>0UTC</sub> | BDT clock bias relative to UTC (seconds)   | Double | 8            | H             |
| 3     | A <sub>1UTC</sub> | BDT clock rate relative to UTC (seconds/second)                                  | Double | 8            | H+8           |
| 4     | ΔT <sub>LS</sub>  | Delta time due to leap seconds before the new leap second is effective (seconds) | Short  | 2            | H+16          |
| 5     | WN <sub>LSF</sub> | Week number of the new leap second   | Ushort | 2            | H+18          |
| 6     | DN                | Day number of week of the new leap second  | Ushort | 2            | H+20          |
| 7     | ΔT <sub>LSF</sub> | Delta time due to leap seconds after the new leap second effective               | Short  | 2            | H+22          |
| 8     | A <sub>0GPS</sub> | BDT clock bias relative to GPS time (seconds)                                    | Double | 8            | H+24          |
| 9     | A <sub>1GPS</sub> | BDT clock rate relative to GPS time (seconds/second)                             | Double | 8            | H+32          |
| 10    | A <sub>0Gal</sub> | BDT clock bias relative to Galileo time (seconds)                                | Double | 8            | H+40          |



| Field | Field Type        | Description  | Format | Binary Bytes | Binary Offset |
|-------|-------------------|--|--------|--------------|---------------|
| 11    | A <sub>1Gal</sub> | BDT clock rate relative to Galileo time (seconds/second) | Double | 8            | H+48          |
| 12    | A <sub>0GLO</sub> | BDT clock bias relative to GLONASS time (seconds)        | Double | 8            | H+56          |
| 13    | A <sub>1GLO</sub> | BDT clock rate relative to GLONASS time (seconds/second) | Double | 8            | H+64          |
| 14    | xxxx              | 32-bit CRC (ASCII and Binary only)                       | Ulong  | 4            | H+72          |
| 15    | [CR][LF]          | Sentence terminator (ASCII only)                         | -      | -            | -             |

## 3.11 BDSEPHEMERIS

### *Decoded BDS ephemeris*

**Platform: OEM719, OEM729, OEM7500, OEM7700, OEM7720, PwrPak7, HxGN PIM7500**

This log contains a single set of BDS ephemeris parameters with appropriate scaling applied. Multiple messages are transmitted, one for each SV ephemeris collected.

**Message ID: 1696**

**Log Type: Asynch**

**Recommended Input:**

```
log bdsephemerisa onchanged
```

**ASCII Example:**

```
#BDSEPHEMERISA,COM1,0,82.5,SATTIME,1774,162464.000,02000000,2626,45436
;13,418,2.00,1,8.20e-09,3.10e-09,11,162000,2.33372441e-04,5.73052716e-
12,8.53809211e-19,12,162000,5282.609060,2.3558507673e-
03,3.122599126,4.1744595973e-09,-0.654635278,1.950232658e+00,-
6.98564812e-09,9.5674299203e-01,3.164417525e-10,4.325527698e-
06,8.850824088e-06,179.3593750,87.5312500,7.171183825e-08,1.024454832e-
08*d8b97536
```

| Field | Field Type          | Description   | Format | Binary Bytes | Binary Offset |
|-------|---------------------|---|--------|--------------|---------------|
| 1     | BDSEPHEMERIS header | Log header. See <i>Messages</i> on page 25 for more information.                          |        | H            | 0             |
| 2     | satellite ID        | ID/ranging code   | Ulong  | 4            | H             |
| 3     | Week                | Week number   | Ulong  | 4            | H+4           |
| 4     | URA                 | User range accuracy (metres). This is the evaluated URAI/URA lookup-table value.          | Double | 8            | H+8           |
| 5     | health 1            | Autonomous satellite health flag. 0 means broadcasting satellite is good and 1 means not. | Ulong  | 4            | H+16          |
| 6     | tgd1                | Equipment group delay differential for the B1 signal (seconds)                            | Double | 8            | H+20          |
| 7     | tgd2                | Equipment group delay differential for the B2 signal (seconds)                            | Double | 8            | H+28          |
| 8     | AODC                | Age of data, clock  | Ulong  | 4            | H+36          |

| Field | Field Type      | Description  | Format | Binary Bytes | Binary Offset |
|-------|-----------------|--|--------|--------------|---------------|
| 9     | toc             | Reference time of clock parameters (seconds)   | Ulong  | 4            | H+40          |
| 10    | a <sub>0</sub>  | Constant term of clock correction polynomial (seconds)   | Double | 8            | H+44          |
| 11    | a <sub>1</sub>  | Linear term of clock correction polynomial (seconds/seconds)                                   | Double | 8            | H+52          |
| 12    | a <sub>2</sub>  | Quadratic term of clock correction polynomial (seconds/seconds <sup>2</sup> )                  | Double | 8            | H+60          |
| 13    | AODE            | Age of data, ephemeris   | Ulong  | 4            | H+68          |
| 14    | toe             | Reference time of ephemeris parameters (seconds)   | Ulong  | 4            | H+72          |
| 15    | RootA           | Square root of semi-major axis (sqrt (metres))   | Double | 8            | H+76          |
| 16    | ecc             | Eccentricity (dimensionless)   | Double | 8            | H+84          |
| 17    | ω               | Argument of perigee (radians)  | Double | 8            | H+92          |
| 18    | ΔN              | Mean motion difference from computed value (radians/second)                                    | Double | 8            | H+100         |
| 19    | M <sub>0</sub>  | Mean anomaly at reference time (radians)   | Double | 8            | H+108         |
| 20    | Ω <sub>0</sub>  | Longitude of ascending node of orbital of plane computed according to reference time (radians) | Double | 8            | H+116         |
| 21    | Ω̇              | Rate of right ascension (radians/second)   | Double | 8            | H+124         |
| 22    | i <sub>0</sub>  | Inclination angle at reference time (radians)  | Double | 8            | H+132         |
| 23    | IDOT            | Rate of inclination angle (radians/second)   | Double | 8            | H+140         |
| 24    | c <sub>uc</sub> | Amplitude of cosine harmonic correction term to the argument of latitude (radians)             | Double | 8            | H+148         |
| 25    | c <sub>us</sub> | Amplitude of sine harmonic correction term to the argument of latitude (radians)               | Double | 8            | H+156         |
| 26    | c <sub>rc</sub> | Amplitude of cosine harmonic correction term to the orbit radius (metres)                      | Double | 8            | H+164         |
| 27    | c <sub>rs</sub> | Amplitude of sine harmonic correction term to the orbit radius (metres)                        | Double | 8            | H+172         |

---

| <b>Field</b> | <b>Field Type</b> | <b>Description</b>   | <b>Format</b> | <b>Binary Bytes</b> | <b>Binary Offset</b> |
|--------------|-------------------|--|---------------|---------------------|----------------------|
| 28           | C <sub>ic</sub>   | Amplitude of cosine harmonic correction term to the angle of inclination (radians) | Double        | 8                   | H+180                |
| 29           | C <sub>is</sub>   | Amplitude of sine harmonic correction term to the angle of inclination (radians)   | Double        | 8                   | H+188                |
| 30           | xxxx              | 32-bit CRC (ASCII and Binary only)   | Ulong         | 4                   | H+196                |
| 31           | [CR][LF]          | Sentence terminator (ASCII only)   | -             | -                   | -                    |

## 3.12 BDSIONO

### *BeiDou Klobuchar ionosphere delay model*

**Platform: OEM719, OEM729, OEM7500, OEM7700, OEM7720, PwrPak7, HxGN PIM7500**

This log contains the Klobuchar ionosphere model parameters transmitted by the BeiDou satellites.

**Message ID: 1590**

**Log Type: Asynch**

**Recommended Input:**

```
log bdsionoa onchanged
```

**ASCII Example:**

```
#BDSIONOA, COM1, 0, 80.0, SATTIME, 1734, 58094.000, 02080000, 1956, 44836; 6,
2.607703208923340e-008, 4.097819328308105e-007, -3.695487976074218e-006,
7.212162017822263e-006, 69632.0, 360448.0, -524288.0, -327680.0*69c2a6c6
```

| Field | Field Type     | Description  | Format | Binary Bytes | Binary Offset |
|-------|----------------|--|--------|--------------|---------------|
| 1     | BDSIONO Header | Log header. See <i>Messages</i> on page 25 for more information.       |        | H            | 0             |
| 2     | ID             | Transmitting satellite ID  | Ulong  | 4            | H             |
| 3     | $\alpha_0$     | Klobuchar cosine curve amplitude constant term (seconds)               | Double | 8            | H+4           |
| 4     | $\alpha_1$     | Klobuchar cosine curve amplitude first-order term (seconds/ $\pi$ )    | Double | 8            | H+12          |
| 5     | $\alpha_2$     | Klobuchar cosine curve amplitude second-order term (seconds/ $\pi^2$ ) | Double | 8            | H+20          |
| 6     | $\alpha_3$     | Klobuchar cosine curve amplitude third-order term (seconds/ $\pi^3$ )  | Double | 8            | H+28          |
| 7     | $\beta_0$      | Klobuchar cosine curve period constant term (seconds)                  | Double | 8            | H+36          |
| 8     | $\beta_1$      | Klobuchar cosine curve period first-order term (seconds/ $\pi$ )       | Double | 8            | H+44          |
| 9     | $\beta_2$      | Klobuchar cosine curve period second-order term (seconds/ $\pi^2$ )    | Double | 8            | H+52          |

---

| Field | Field Type | Description  | Format | Binary Bytes | Binary Offset |
|-------|------------|--|--------|--------------|---------------|
| 10    | $\beta_3$  | Klobuchar cosine curve period third-order term (seconds/ $\pi^3$ ) | Double | 8            | H+60          |
| 11    | xxxx       | 32-bit CRC (ASCII and Binary only)                                 | Ulong  | 4            | H+68          |
| 12    | [CR][LF]   | Sentence terminator (ASCII only)                                   | -      | -            | -             |

### 3.13 BDSRAWNAVSUBFRAME

#### *Raw BeiDou subframe data*

**Platform: OEM719, OEM729, OEM7500, OEM7700, OEM7720, PwrPak7, HxGN PIM7500**

This log contains the raw BeiDou subframe data with parity bits removed. Only subframes that have passed the parity check are output.

**Message ID: 1695**

**Log Type: Asynch**

**Recommended Input:**

```
log bdsrawnavsubframea onchanged
```

**ASCII Example:**

```
#BDSRAWNAVSUBFRAMEA, COM1, 0, 85.5, SATTIME, 1774, 162554.000, 02000000, 88f3,
45436;84, 13, B1D1, 1, e24049ebb2b00d113c685207c4d0ee9fd1bf364e41f8f4b5700
3268c*6b1f478b
```

| Field | Field Type               | Description  | Format  | Binary Bytes | Binary Offset |
|-------|--------------------------|--|---------|--------------|---------------|
| 1     | BDSRAWNAVSUBFRAME header | Log header. See <i>Messages</i> on page 25 for more information. |         | H            | 0             |
| 2     | signal channel           | Signal channel number  | Ulong   | 4            | H             |
| 3     | satellite ID             | Satellite ID   | Ulong   | 4            | H+4           |
| 4     | data source              | Source of data (refer to <i>Table 72: Data Source</i> below)     | Enum    | 4            | H+8           |
| 5     | subframe ID              | Subframe identifier  | Ulong   | 4            | H+12          |
| 6     | raw subframe data        | Framed raw navigation bits                                       | Hex[28] | 28           | H+16          |
| 7     | xxxx                     | 32-bit CRC (ASCII and Binary only)                               | Hex     | 4            | H+44          |
| 8     | [CR][LF]                 | Sentence terminator (ASCII only)                                 | -       | -            | -             |

**Table 72: Data Source**

| ASCII | Binary | Description                 |
|-------|--------|-----------------------------|
| B1D1  | 0      | Data is from a B1/D1 signal |
| B1D2  | 1      | Data is from a B1/D2 signal |
| B2D1  | 65536  | Data is from a B2/D1 signal |
| B2D2  | 65537  | Data is from a B2/D2 signal |

## 3.14 BESTPOS

### *Best position*

**Platform: OEM719, OEM729, OEM7500, OEM7700, OEM7720, PwrPak7, HxGN PIM7500**

When positioning with GNSS, there are four parameters being solved for: latitude, longitude, height and receiver clock offset from GPS time. The quality of the solution for all four parameters depends on the geometry of where the satellites are with respect to the antenna (and receiver). The strength of the positioning geometry is indicated by Dilution of Precision (DOP) values, with lower DOP numbers indicating better geometry. Because all the GNSS satellites are above terrestrial receivers, the VDOP (vertical DOP) is the largest DOP value. This is why the reported standard deviation for height is usually larger than for latitude or longitude.

Accuracy is based on statistics and reliability is measured in percentages. When a receiver states it can measure height to one metre, this is an accuracy measure. Usually this is a one sigma value (one SD). A one sigma value for height has a reliability of 68%. In other words, the error is less than one metre 68% of the time. For a more realistic accuracy, double the one sigma value (one metre) and the result is 95% reliability (error is less than two metres 95% of the time). Generally, GNSS heights are 1.5 times poorer than horizontal positions. See also the note in the **GPGST** log on page 508 for CEP and RMS definitions.

This log contains the best position computed by the receiver. In addition, it reports several status indicators, including differential age, which is useful in predicting anomalous behavior brought about by outages in differential corrections. A differential age of 0 indicates that no differential correction was used.



#### **SPAN Systems**

On systems with SPAN enabled, this log contains the best available combined GNSS and Inertial Navigation System (INS - if available) position (in metres) computed by the receiver.

With the system operating in an RTK mode, BESTPOS reflects the latest low-latency solution for up to 60 seconds after reception of the last base station observation. After this 60 second period, the position reverts to the best solution available and the degradation in accuracy is reflected in the standard deviation fields. If the system is not operating in RTK mode, pseudorange differential solutions continue for the time specified in the **PSRDIFFTIMEOUT** command (see page 279). If the receiver is SPAN enabled, the GNSS/INS combined solution is also a candidate for BESTPOS output.





The RTK system in the receiver provides two kinds of position solutions. The Matched RTK position is computed with buffered observations, so there is no error due to the extrapolation of base station measurements. This provides the highest accuracy solution possible at the expense of some latency which is affected primarily by the speed of the differential data link. The **MATCHEDPOS** log (see page 576) contains the matched RTK solution and can be generated for each processed set of base station observations.

The Low-Latency RTK position is computed from the latest local observations and extrapolated base station observations. This supplies a valid RTK position with the lowest latency possible at the expense of some accuracy. The degradation in accuracy is reflected in the standard deviation and is summarized in [An Introduction to GNSS](#) available on our website. The amount of time that the base station observations are extrapolated is in the "differential age" field of the position log. The Low-Latency RTK system extrapolates for 60 seconds. The **RTKPOS** log (see page 722) contains the Low-Latency RTK position when valid, and an "invalid" status when a Low-Latency RTK solution could not be computed. The **BESTPOS** log contains either the low-latency RTK, PPP or pseudorange-based position, whichever has the smallest standard deviation.



Multi-frequency GNSS receivers offer two major advantages over single-frequency equipment:

- Ionospheric errors, inherent in all GNSS observations, can be modeled and significantly reduced by combining satellite observations made on two different frequencies.
- Observations on two frequencies allow for faster ambiguity resolution times.

In general, multi-frequency GNSS receivers provide a faster, more accurate and more reliable solution than single-frequency equipment. They do, however, cost significantly more and so it is important for potential GNSS buyers to carefully consider their current and future needs.



Different positioning modes have different maximum logging rates, which are also controlled by model option. The maximum rates are: 100 Hz for RTK, 100 Hz for pseudorange based positioning, 20 Hz for GLIDE (PDP) and 20 Hz for PPP.



**BESTPOS** always outputs positions at the antenna phase center.

**Message ID: 42**

**Log Type: Synch**

**Recommended Input:**

```
log bestposa ontime 1
```

**ASCII Example 1:**

```
#BESTPOSA,COM1,0,90.5,FINESTEERING,1949,403742.000,02000000,b1f6,32768
;SOL_COMPUTED,SINGLE,51.11636937989,-114.03825348307,1064.533,-
16.9000,WGS84,1.3610,1.0236,2.4745,"",0.000,0.000,19,19,19,19,00,06,00
,33*6e08fa22
```

**ASCII Example 2:**

```
#BESTPOSA,COM1,0,78.5,FINESTEERING,1419,336208.000,02000040,6145,2724;
SOL_COMPUTED,NARROW_INT,51.11635910984,-114.03833105168,1063.8416,-
16.2712,WGS84,0.0135,0.0084,0.0172,"AAAA",1.000,0.000,8,8,8,8,0,01,0,0
3*3d9fbd48
```

| Field | Field type     | Description   | Format  | Binary Bytes | Binary Offset |
|-------|----------------|---|---------|--------------|---------------|
| 1     | BESTPOS header | Log header. See <i>Messages</i> on page 25 for more information.  |         | H            | 0             |
| 2     | sol stat       | Solution status, see <i>Table 73: Solution Status</i> on the next page  | Enum    | 4            | H             |
| 3     | pos type       | Position type, see <i>Table 74: Position or Velocity Type</i> on page 420   | Enum    | 4            | H+4           |
| 4     | lat            | Latitude (degrees)  | Double  | 8            | H+8           |
| 5     | lon            | Longitude (degrees)   | Double  | 8            | H+16          |
| 6     | hgt            | Height above mean sea level (metres)  | Double  | 8            | H+24          |
| 7     | undulation     | Undulation - the relationship between the geoid and the ellipsoid (m) of the chosen datum<br><br><div style="border: 1px solid black; padding: 5px; width: fit-content;">  <p>When using a datum other than WGS84, the undulation value also includes the vertical shift due to differences between the datum in use and WGS84.</p> </div> | Float   | 4            | H+32          |
| 8     | datum id#      | Datum ID number (see <i>Table 28: Datum Transformation Parameters</i> on page 116)  | Enum    | 4            | H+36          |
| 9     | lat $\sigma$   | Latitude standard deviation (m)   | Float   | 4            | H+40          |
| 10    | lon $\sigma$   | Longitude standard deviation (m)  | Float   | 4            | H+44          |
| 11    | hgt $\sigma$   | Height standard deviation (m)   | Float   | 4            | H+48          |
| 12    | stn id         | Base station ID   | Char[4] | 4            | H+52          |
| 13    | diff_age       | Differential age in seconds   | Float   | 4            | H+56          |

| Field | Field type                  | Description   | Format | Binary Bytes | Binary Offset |
|-------|-----------------------------|---|--------|--------------|---------------|
| 14    | sol_age                     | Solution age in seconds   | Float  | 4            | H+60          |
| 15    | #SVs                        | Number of satellites tracked  | Uchar  | 1            | H+64          |
| 16    | #solnSVs                    | Number of satellites used in solution   | Uchar  | 1            | H+65          |
| 17    | #solnL1SVs                  | Number of satellites with L1/E1/B1 signals used in solution   | Uchar  | 1            | H+66          |
| 18    | #solnMultiSVs               | Number of satellites with multi-frequency signals used in solution  | Uchar  | 1            | H+67          |
| 19    | Reserved                    |   | Hex    | 1            | H+68          |
| 20    | ext sol stat                | Extended solution status (see <i>Table 77: Extended Solution Status</i> on page 423)                        | Hex    | 1            | H+69          |
| 21    | Galileo and BeiDou sig mask | Galileo and BeiDou signals used mask (see <i>Table 76: Galileo and BeiDou Signal-Used Mask</i> on page 423) | Hex    | 1            | H+70          |
| 22    | GPS and GLONASS sig mask    | GPS and GLONASS signals used mask (see <i>Table 75: GPS and GLONASS Signal-Used Mask</i> on page 422)       | Hex    | 1            | H+71          |
| 23    | xxxx                        | 32-bit CRC (ASCII and Binary only)  | Hex    | 4            | H+72          |
| 24    | [CR][LF]                    | Sentence terminator (ASCII only)  | -      | -            | -             |

**Table 73: Solution Status**

| Binary | ASCII            | Description  |
|--------|------------------|--|
| 0      | SOL_COMPUTED     | Solution computed  |
| 1      | INSUFFICIENT_OBS | Insufficient observations  |
| 2      | NO_CONVERGENCE   | No convergence   |
| 3      | SINGULARITY      | Singularity at parameters matrix                                     |
| 4      | COV_TRACE        | Covariance trace exceeds maximum (trace > 1000 m)                    |
| 5      | TEST_DIST        | Test distance exceeded (maximum of 3 rejections if distance > 10 km) |
| 6      | COLD_START       | Not yet converged from cold start                                    |

| Binary | ASCII             | Description  |
|--------|-------------------|--|
| 7      | V_H_LIMIT         | Height or velocity limits exceeded (in accordance with export licensing restrictions)  |
| 8      | VARIANCE          | Variance exceeds limits  |
| 9      | RESIDUALS         | Residuals are too large  |
| 10-12  | Reserved          |  |
| 13     | INTEGRITY_WARNING | Large residuals make position unreliable   |
| 14-17  | Reserved          |  |
| 18     | PENDING           | <p>When a <b>FIX position</b> command is entered, the receiver computes its own position and determines if the fixed position is valid</p> <div style="border: 1px solid black; padding: 10px; margin: 10px 0;"> <p> PENDING implies there are not enough satellites currently tracked to verify if the FIX POSITION entered into the receiver is valid. Under normal conditions, you should only see PENDING for a few seconds on power up before the GNSS receiver has locked onto its first few satellites. If your antenna is obstructed (or not plugged in) and you have entered a FIX POSITION command, then you may see PENDING indefinitely.</p> </div> |
| 19     | INVALID_FIX       | The fixed position, entered using the <b>FIX position</b> command, is not valid  |
| 20     | UNAUTHORIZED      | Position type is unauthorized  |
| 21     | Reserved          |  |
| 22     | INVALID_RATE      | The selected logging rate is not supported for this solution type.   |

**Table 74: Position or Velocity Type**

| Binary | ASCII       | Description  |
|--------|-------------|--|
| 0      | NONE        | No solution  |
| 1      | FIXEDPOS    | Position has been fixed by the <b>FIX position</b> command or by position averaging.                 |
| 2      | FIXEDHEIGHT | Position has been fixed by the <b>FIX height</b> or <b>FIX auto</b> command or by position averaging |
| 3      | Reserved    |  |
| 4      | FLOATCONV   | Solution from floating point carrier phase ambiguities   |

| Binary | ASCII            | Description   |
|--------|------------------|---|
| 5      | WIDELANE         | Solution from wide-lane ambiguities   |
| 6      | NARROWLANE       | Solution from narrow-lane ambiguities                                       |
| 7      | Reserved         |   |
| 8      | DOPPLER_VELOCITY | Velocity computed using instantaneous Doppler                               |
| 9-15   | Reserved         |   |
| 16     | SINGLE           | Single point position   |
| 17     | PSRDIFF          | Pseudorange differential solution   |
| 18     | WAAS             | Solution calculated using corrections from an SBAS                          |
| 19     | PROPAGATED       | Propagated by a Kalman filter without new observations                      |
| 20-31  | Reserved         |   |
| 32     | L1_FLOAT         | Floating L1 ambiguity solution  |
| 33     | IONOFREE_FLOAT   | Floating ionospheric-free ambiguity solution                                |
| 34     | NARROW_FLOAT     | Floating narrow-lane ambiguity solution                                     |
| 35-47  | Reserved         |   |
| 48     | L1_INT           | Integer L1 ambiguity solution   |
| 49     | WIDE_INT         | Integer wide-lane ambiguity solution  |
| 50     | NARROW_INT       | Integer narrow-lane ambiguity solution                                      |
| 51     | RTK_DIRECT_INS   | RTK status where the RTK filter is directly initialized from the INS filter |
| 52     | INS_SBAS         | INS calculated position corrected for the antenna                           |
| 53     | INS_PSRSP        | INS pseudorange single point solution – no DGPS corrections                 |
| 54     | INS_PSRDIFF      | INS pseudorange differential solution                                       |
| 55     | INS_RTKFLOAT     | INS RTK floating point ambiguities solution                                 |
| 56     | INS_RTKFIXED     | INS RTK fixed ambiguities solution  |
| 57-67  | Reserved         |   |
| 68     | PPP_CONVERGING   | Converging TerraStar-C solution   |
| 69     | PPP              | Converged TerraStar-C solution  |

| Binary | ASCII                    | Description   |
|--------|--------------------------|---|
| 70     | OPERATIONAL              | Solution accuracy is within UAL operational limit                           |
| 71     | WARNING                  | Solution accuracy is outside UAL operational limit but within warning limit |
| 72     | OUT_OF_BOUNDS            | Solution accuracy is outside UAL limits                                     |
| 73     | INS_PPP_CONVERGING       | INS NovAtel CORRECT Precise Point Positioning (PPP) solution converging     |
| 74     | INS_PPP                  | INS NovAtel CORRECT PPP solution  |
| 77     | PPP_BASIC_CONVERGING     | Converging TerraStar-L solution   |
| 78     | PPP_BASIC                | Converged TerraStar-L solution  |
| 79     | INS_PPP_BASIC            | INS NovAtel CORRECT PPP basic solution                                      |
| 80     | INS_PPP_BASIC_CONVERGING | INS NovAtel CORRECT PPP basic solution converging                           |



NovAtel CORRECT™ with PPP requires access to a suitable correction stream, delivered either through L-Band or the Internet. For L-Band delivered TerraStar or Veripos service, an L-Band capable receiver and software model is required, along with a subscription to the desired service. Contact NovAtel for TerraStar and Veripos subscription details.

**Table 75: GPS and GLONASS Signal-Used Mask**

| Bit | Mask | Description                 |
|-----|------|-----------------------------|
| 0   | 0x01 | GPS L1 used in Solution     |
| 1   | 0x02 | GPS L2 used in Solution     |
| 2   | 0x04 | GPS L5 used in Solution     |
| 3   | 0x08 | Reserved                    |
| 4   | 0x10 | GLONASS L1 used in Solution |
| 5   | 0x20 | GLONASS L2 used in Solution |
| 6   | 0x40 | GLONASS L3 used in Solution |
| 7   | 0x80 | Reserved                    |

**Table 76: Galileo and BeiDou Signal-Used Mask**

| Bit | Mask | Description                     |
|-----|------|---------------------------------|
| 0   | 0x01 | Galileo E1 used in Solution     |
| 1   | 0x02 | Galileo E5A used in Solution    |
| 2   | 0x04 | Galileo E5B used in Solution    |
| 3   | 0x08 | Galileo ALTBOC used in Solution |
| 4   | 0x10 | BeiDou B1 used in Solution      |
| 5   | 0x20 | BeiDou B2 used in Solution      |
| 6   | 0x40 | BeiDou B3 used in Solution      |
| 7   | 0x80 | Reserved                        |

**Table 77: Extended Solution Status**

| Bit | Mask | Description  |
|-----|------|--|
| 0   | 0x01 | If an RTK solution: NovAtel CORRECT solution has been verified<br>If a PDP solution: solution is GLIDE<br>Otherwise: Reserved  |
| 1-3 | 0x0E | Pseudorange Iono Correction<br>0 = Unknown or default Klobuchar model<br>1 = Klobuchar Broadcast<br>2 = SBAS Broadcast<br>3 = Multi-frequency Computed<br>4 = PSRDiff Correction<br>5 = NovAtel Blended Iono Value |
| 4   | 0x10 | RTK ASSIST active  |
| 5   | 0x20 | 0 - No antenna warning<br>1 - Antenna information is missing<br>See the <b>RTKANTENNA</b> command on page 290  |
| 6-7 | 0xC0 | Reserved   |

**Table 78: Supplemental Position Types and NMEA Equivalents**

| <b>Value</b> | <b>Documented Enum Name</b> | <b>NMEA Equivalent</b> |
|--------------|-----------------------------|------------------------|
| 68           | PPP_CONVERGING              | 2                      |
| 69           | PPP                         | 5                      |
| 70           | OPERATIONAL                 | 4                      |
| 71           | WARNING                     | 5                      |
| 72           | OUT_OF_BOUNDS               | 1                      |
| 77           | PPP_BASIC_CONVERGING        | 1                      |
| 78           | PPP_BASIC                   | 2                      |



## 3.15 BESTSATS

### *Satellites used in BESTPOS*

**Platform: OEM719, OEM729, OEM7500, OEM7700, OEM7720, PwrPak7, HxGN PIM7500**

This log lists the used and unused satellites for the corresponding BESTPOS solution. It also describes the signals of the used satellites or reasons for exclusions.

**Message ID: 1194**

**Log Type: Synch**

**Recommended Input:**

```
log bestsats ontime 1
```

**Abbreviated ASCII Example:**

```
<BESTSATS COM1 0 57.5 FINESTEERING 1729 12132.000 02000000 95e7 11487
<   26
<       GPS 3 GOOD 00000003
<       GPS 5 GOOD 00000003
...
<       GPS 26 GOOD 00000003
<       GPS 28 GOOD 00000003
<       GLONASS 3+5 GOOD 00000003
<       GLONASS 4+6 GOOD 00000003
...
<       GLONASS 23+3 GOOD 00000003
<       GLONASS 24+2 GOOD 00000003
<       BEIDOU 6 GOOD 00000003
<       BEIDOU 9 GOOD 00000003
...
<       BEIDOU 12 GOOD 00000003
<       BEIDOU 13 GOOD 00000003
```

| Field | Field type      | Description  | Format | Binary Bytes | Binary Offset |
|-------|-----------------|--|--------|--------------|---------------|
| 1     | BESTSATS header | Log header. See <i>Messages</i> on page 25 for more information. |        | H            | 0             |
| 2     | #entries        | Number of records to follow                                      | Ulong  | 4            | H             |
| 3     | System          | See <i>Table 102: Satellite System</i> on page 532               | Enum   | 4            | H+4           |

| Field | Field type                                      | Description   | Format | Binary Bytes | Binary Offset          |
|-------|---|---|--------|--------------|------------------------|
| 4     | Satellite ID                                    | In binary logs, the satellite ID field is 4 bytes. The 2 lowest-order bytes, interpreted as a USHORT, are the system identifier: for instance, the PRN for GPS, or the slot for GLONASS. The 2 highest-order bytes are the frequency channel for GLONASS, interpreted as a SHORT and zero for all other systems.<br><br>In ASCII and abbreviated ASCII logs, the satellite ID field is the system identifier. If the system is GLONASS and the frequency channel is not zero, then the signed channel is appended to the system identifier. For example, slot 13, frequency channel -2 is output as 13-2. | Ulong  | 4            | H+8                    |
| 5     | Status  | Satellite status. See <i>Table 79: Observation Statuses</i> below   | Enum   | 4            | H+12                   |
| 6     | Signal mask                                     | See <i>Table 80: BESTSATS GPS Signal Mask</i> on the next page, <i>Table 81: BESTSATS GLONASS Signal Mask</i> on page 428, <i>Table 82: BESTSATS Galileo Signal Mask</i> on page 428 and <i>Table 83: BESTSATS BeiDou Signal Mask</i> on page 428   | Hex    | 4            | H+16                   |
| 7     | Next satellite offset = H + 4 + (#entries x 16) |   |        |              |                        |
| 8     | xxxx  | 32-bit CRC (ASCII and Binary only)  | Hex    | 4            | H+4<br>(#entries x 16) |
| 9     | [CR][LF]  | Sentence terminator (ASCII only)  | -      | -            | -                      |

**Table 79: Observation Statuses**

| Value | Name           | Description  |
|-------|----------------|--|
| 0     | GOOD           | Observation is good  |
| 1     | BADHEALTH      | Satellite is flagged as bad health in ephemeris or almanac |
| 2     | OLDEPHEMERIS   | Ephemeris >3 hours old                                     |
| 6     | ELEVATIONERROR | Satellite was below the elevation cutoff                   |
| 7     | MISCLOSURE     | Observation was too far from predicted value               |

| Value | Name          | Description  |
|-------|---------------|--|
| 8     | NODIFFCORR    | No differential correction available                             |
| 9     | NOEPHEMERIS   | No ephemeris available   |
| 10    | INVALIDIODE   | IODE used is invalid   |
| 11    | LOCKEDOUT     | Satellite has been locked out                                    |
| 12    | LOWPOWER      | Satellite has low signal power                                   |
| 13    | OBSL2         | An L2 observation not directly used in the solution              |
| 15    | UNKNOWN       | Observation was not used because it was of an unknown type       |
| 16    | NOIONOCORR    | No ionosphere delay correction was available                     |
| 17    | NOTUSED       | Observation was not used in the solution                         |
| 18    | OBSL1         | An L1 observation not directly used in the solution              |
| 19    | OBSE1         | An E1 observation not directly used in the solution              |
| 20    | OBSL5         | An L5 observation not directly used in the solution              |
| 21    | OBSE5         | An E5 observation not directly used in the solution              |
| 22    | OBSB2         | A B2 observation not directly used in the solution               |
| 23    | OBSB1         | A B1 observation not directly used in the solution               |
| 24    | OBSB3         | A B3 observation not directly used in the solution               |
| 25    | NOSIGNALMATCH | Signal type does not match                                       |
| 26    | SUPPLEMENTARY | Observation contributes supplemental information to the solution |
| 99    | NA            | No observation available   |
| 100   | BAD_INTEGRITY | Observation was an outlier and was eliminated from the solution  |
| 101   | LOSSOFLOCK    | Lock was broken on this signal                                   |
| 102   | NOAMBIGUITY   | No RTK ambiguity type resolved                                   |

**Table 80: BESTSATS GPS Signal Mask**

| Bit | Mask | Description             |
|-----|------|-------------------------|
| 0   | 0x01 | GPS L1 used in Solution |
| 1   | 0x02 | GPS L2 used in Solution |
| 2   | 0x04 | GPS L5 used in Solution |

**Table 81: BESTSATS GLONASS Signal Mask**

| Bit | Mask | Description                 |
|-----|------|-----------------------------|
| 0   | 0x01 | GLONASS L1 used in Solution |
| 1   | 0x02 | GLONASS L2 used in Solution |
| 2   | 0x04 | GLONASS L3 used in Solution |

**Table 82: BESTSATS Galileo Signal Mask**

| Bit | Mask | Description                     |
|-----|------|---------------------------------|
| 0   | 0x01 | Galileo E1 used in Solution     |
| 1   | 0x02 | Galileo E5A used in Solution    |
| 2   | 0x04 | Galileo E5B used in Solution    |
| 3   | 0x08 | Galileo ALTBOC used in Solution |

**Table 83: BESTSATS BeiDou Signal Mask**

| Bit | Mask | Description                |
|-----|------|----------------------------|
| 0   | 0x01 | BeiDou B1 used in Solution |
| 1   | 0x02 | BeiDou B2 used in Solution |
| 2   | 0X04 | BeiDou B3 used in Solution |

## 3.16 BESTUTM

### *Best available UTM data*

**Platform: OEM719, OEM729, OEM7500, OEM7700, OEM7720, PwrPak7, HxGN PIM7500**

This log contains the best available position computed by the receiver in UTM coordinates.

See also the **UTMZONE** command on page 385 and the **BESTPOS** log on page 416.



The latitude limits of the UTM System are 80°S to 84°N. If your position is outside this range, the BESTUTM log outputs a northing, easting and height of 0.0, along with a zone letter of '\*' and a zone number of 0, to indicate that the data in the log is unusable.



Refer to <http://earth-info.nga.mil/GandG/coordsys/grids/referencesys.html> for more information and a world map of UTM zone numbers.

**Message ID: 726**

**Log Type: Synch**

**Recommended Input:**

```
log bestutma ontime 1
```

**ASCII Example:**

```
#BESTUTMA,COM1,0,73.0,FINESTEERING,1419,336209.000,02000040,eb16,2724;
SOL_COMPUTED,NARROW_INT,11,U,5666936.4417,707279.3875,1063.8401,-
16.2712,WGS84,0.0135,0.0084,0.0173,"AAAA",1.000,0.000,8,8,8,8,0,01,0,0
3*a6d06321
```

| Field | Field type     | Description   | Format | Binary Bytes | Binary Offset |
|-------|----------------|---|--------|--------------|---------------|
| 1     | BESTUTM header | Log header. See <i>Messages</i> on page 25 for more information.          |        | H            | 0             |
| 2     | sol status     | Solution status, see <i>Table 73: Solution Status</i> on page 419         | Enum   | 4            | H             |
| 3     | pos type       | Position type, see <i>Table 74: Position or Velocity Type</i> on page 420 | Enum   | 4            | H+4           |
| 4     | z#             | Longitudinal zone number  | Ulong  | 4            | H+8           |
| 5     | zletter        | Latitudinal zone letter   | Ulong  | 4            | H+12          |

| Field | Field type   | Description   | Format  | Binary Bytes | Binary Offset |
|-------|--------------|---|---------|--------------|---------------|
| 6     | northing     | Northing (m) where the origin is defined as the equator in the northern hemisphere and as a point 10000000 metres south of the equator in the southern hemisphere (that is, a 'false northing' of 10000000 m)   | Double  | 8            | H+16          |
| 7     | easting      | Easting (m) where the origin is 500000 m west of the central meridian of each longitudinal zone (that is, a 'false easting' of 500000 m)  | Double  | 8            | H+24          |
| 8     | hgt          | Height above mean sea level (m)   | Double  | 8            | H+32          |
| 9     | undulation   | Undulation - the relationship between the geoid and the ellipsoid (m) of the chosen datum<br><br><div style="border: 1px solid black; padding: 5px; width: fit-content; margin: 10px auto;">  When using a datum other than WGS84, the undulation value also includes the vertical shift due to differences between the datum in use and WGS84. </div> | Float   | 4            | H+40          |
| 10    | datum id#    | Datum ID number (see <i>Table 28: Datum Transformation Parameters</i> on page 116)  | Enum    | 4            | H+44          |
| 11    | N $\sigma$   | Northing standard deviation (m)   | Float   | 4            | H+48          |
| 12    | E $\sigma$   | Easting standard deviation (m)  | Float   | 4            | H+52          |
| 13    | hgt $\sigma$ | Height standard deviation (m)   | Float   | 4            | H+56          |
| 14    | stn id       | Base station ID   | Char[4] | 4            | H+60          |
| 15    | diff_age     | Differential age in seconds   | Float   | 4            | H+64          |
| 16    | sol_age      | Solution age in seconds   | Float   | 4            | H+68          |
| 17    | #SVs         | Number of satellites tracked  | Uchar   | 1            | H+72          |
| 18    | #solnSVs     | Number of satellite vehicles used in solution   | Uchar   | 1            | H+73          |
| 19    | #ggL1        | Number of GPS plus GLONASS plus BDS L1/B1 used in solution  | Uchar   | 1            | H+74          |
| 20    | #solnMultiSV | Number of satellites with L1/E1/B1 signals used in solution   | Uchar   | 1            | H+75          |
| 21    | Reserved     |   | Uchar   | 1            | H+76          |

| Field | Field type                  | Description   | Format | Binary Bytes | Binary Offset |
|-------|-----------------------------|---|--------|--------------|---------------|
| 22    | ext sol stat                | Extended solution status (see <i>Table 77: Extended Solution Status</i> on page 423)                        | Hex    | 1            | H+77          |
| 23    | Galileo and BeiDou sig mask | Galileo and BeiDou signals used mask (see <i>Table 76: Galileo and BeiDou Signal-Used Mask</i> on page 423) | Hex    | 1            | H+78          |
| 24    | GPS and GLONASS sig mask    | GPS and GLONASS signals used mask (see <i>Table 75: GPS and GLONASS Signal-Used Mask</i> on page 422)       | Hex    | 1            | H+79          |
| 25    | xxxx                        | 32-bit CRC (ASCII and Binary only)  | Hex    | 4            | H+80          |
| 26    | [CR][LF]                    | Sentence terminator (ASCII only)  | -      | -            | -             |

## 3.17 BESTVEL

### *Best available velocity data*

**Platform: OEM719, OEM729, OEM7500, OEM7700, OEM7720, PwrPak7, HxGN PIM7500**

This log contains the best available velocity information computed by the receiver. In addition, it reports a velocity status indicator, which is needed to determine whether or not the corresponding data is valid. The velocities calculated by the receiver can have a latency associated with them. When present, the velocity time of validity is the time tag in the log minus the latency value.



The velocity is typically from the same source used in the BESTPOS solution. For example, if the BESTPOS is from the pseudorange filter, then the BESTVEL velocity type is the same as for PSRVEL. However, a specific velocity source can be chosen. See the **BESTVELTYPE** command on page 95.



In a BESTVEL log, the actual speed and direction of the receiver antenna over ground is provided. The receiver does not determine the direction a vessel, craft or vehicle is pointed (heading) but rather the direction of motion of the GNSS antenna relative to ground.

The RTK, PDP and PPP velocities are computed from the average change in position over the time interval between consecutive solutions. As such, they are an average velocity based on the time difference between successive position computations and not an instantaneous velocity at the BESTVEL time tag. The velocity latency to be subtracted from the time tag is normally half the time between filter updates. Under default operation, the positioning filters are updated at a rate of 2 Hz. *This average velocity translates into a velocity latency of 0.25 seconds.* To reduce the latency, increase the update rate of the positioning filter being used by requesting the BESTVEL or BESTPOS messages at a rate higher than 2 Hz. For example, a logging rate of 10 Hz would reduce the velocity latency to 0.05 seconds.

If the velocity in the BESTVEL log comes from the pseudorange filter, it has been computed from instantaneous Doppler measurements. You know that you have an instantaneous Doppler derived velocity solution when the velocity type is PSRDIFF, WAAS or DOPPLER\_VELOCITY. The instantaneous Doppler derived velocity has low latency and is not position change dependent. If you change your velocity quickly, you can see this in the DOPPLER\_VELOCITY solution. Under typically seen dynamics with minimal jerk, the velocity latency is zero. Under extreme, high-jerk dynamics, the latency cannot be well represented: it will still be reported as being zero, but may be as high as 0.15 seconds. Such dynamics are typically only seen in simulated trajectories.

**Message ID: 99**

**Log Type: Synch**

**Recommended Input:**

```
log bestvela ontime 1
```

**ASCII Example:**



```
#BESTVELA,COM1,0,61.0,FINESTEERING,1337,334167.000,02000000,827b,1984;
SOL_COMPUTED,PSRDIFF,0.250,4.000,0.0206,227.712486,0.0493,0.0*0e68bf05
```

| Field | Field type     | Description   | Format | Binary Bytes | Binary Offset |
|-------|----------------|---|--------|--------------|---------------|
| 1     | BESTVEL header | Log header. See <i>Messages</i> on page 25 for more information.  |        | H            | 0             |
| 2     | sol status     | Solution status, see <i>Table 73: Solution Status</i> on page 419   | Enum   | 4            | H             |
| 3     | vel type       | Velocity type, see <i>Table 74: Position or Velocity Type</i> on page 420   | Enum   | 4            | H+4           |
| 4     | latency        | A measure of the latency in the velocity time tag in seconds. It should be subtracted from the time to give improved results (s)                      | Float  | 4            | H+8           |
| 5     | age            | Differential age in seconds   | Float  | 4            | H+12          |
| 6     | hor spd        | Horizontal speed over ground, in metres per second  | Double | 8            | H+16          |
| 7     | trk gnd        | Actual direction of motion over ground (track over ground) with respect to True North, in degrees   | Double | 8            | H+24          |
| 8     | vert spd       | Vertical speed, in metres per second, where positive values indicate increasing altitude (up) and negative values indicate decreasing altitude (down) | Double | 8            | H+32          |
| 9     | Reserved       |   | Float  | 4            | H+40          |
| 10    | xxxx           | 32-bit CRC (ASCII and Binary only)  | Hex    | 4            | H+44          |
| 11    | [CR][LF]       | Sentence terminator (ASCII only)  | -      | -            | -             |



Velocity (speed and direction) calculations are computed from either Doppler or carrier phase measurements rather than from pseudorange measurements. Typical speed accuracies are around 0.03m/s (0.07 mph, 0.06 knots).

Direction accuracy is derived as a function of the vehicle speed. A simple approach would be to assume a worst case 0.03 m/s cross-track velocity that would yield a direction error function something like:

$$d(\text{speed}) = \tan^{-1}(0.03/\text{speed})$$

For example, if you are flying in an airplane at a speed of 120 knots or 62 m/s, the approximate directional error will be:

$$\tan^{-1}(0.03/62) = 0.03 \text{ degrees}$$

Consider another example applicable to hiking at an average walking speed of 3 knots or 1.5 m/s. Using the same error function yields a direction error of about 1.15 degrees.

You can see from both examples that a faster vehicle speed allows for a more accurate heading indication. As the vehicle slows down, the velocity information becomes less and less accurate. If the vehicle is stopped, a GNSS receiver still outputs some kind of movement at speeds between 0 and 0.5 m/s in random and changing directions. This represents the noise and error of the static position.

In a navigation capacity, the velocity information provided by your GNSS receiver is as, or more, accurate than that indicated by conventional instruments as long as the vehicle is moving at a reasonable rate of speed. It is important to set the GNSS measurement rate fast enough to keep up with all major changes of the vehicle's speed and direction. It is important to keep in mind that although the velocity vector is quite accurate in terms of heading and speed, the actual track of the vehicle might be skewed or offset from the true track by plus or minus 0 to 1.8 metres as per the standard positional errors.

## 3.18 BESTXYZ

### *Best available cartesian position and velocity*

**Platform: OEM719, OEM729, OEM7500, OEM7700, OEM7720, PwrPak7, HxGN PIM7500**

This log contains the receiver's best available position and velocity in ECEF coordinates. The position and velocity status fields indicate whether or not the corresponding data is valid. See *Figure 11: The WGS84 ECEF Coordinate System* on page 437, for a definition of the ECEF coordinates.

See also the **BESTPOS** log on page 416 and **BESTVEL** log on page 432.



These quantities are always referenced to the WGS84 ellipsoid, regardless of the use of the **DATUM** command (see page 114) or **USERDATUM** command (see page 380).

**Message ID: 241**

**Log Type: Synch**

**Recommended Input:**

```
log bestxyza ontime 1
```

**ASCII Example:**

```
#BESTXYZA,COM1,0,55.0,FINESTEERING,1419,340033.000,02000040,d821,2724;
SOL_COMPUTED,NARROW_INT,-1634531.5683,-
3664618.0326,4942496.3270,0.0099,0.0219,0.0115,SOL_COMPUTED,NARROW_
INT,0.0011,-0.0049,-
0.0001,0.0199,0.0439,0.0230,"AAAA",0.250,1.000,0.000,12,11,11,11,0,01,
0,33*e9eafeca
```

| Field | Field type     | Description   | Format | Binary Bytes | Binary Offset |
|-------|----------------|---|--------|--------------|---------------|
| 1     | BESTXYZ header | Log header. See <i>Messages</i> on page 25 for more information.          |        | H            | 0             |
| 2     | P-sol status   | Solution status, see <i>Table 73: Solution Status</i> on page 419         | Enum   | 4            | H             |
| 3     | pos type       | Position type, see <i>Table 74: Position or Velocity Type</i> on page 420 | Enum   | 4            | H+4           |
| 4     | P-X            | Position X-coordinate (m)   | Double | 8            | H+8           |
| 5     | P-Y            | Position Y-coordinate (m)   | Double | 8            | H+16          |
| 6     | P-Z            | Position Z-coordinate (m)   | Double | 8            | H+24          |

| Field | Field type                  | Description  | Format  | Binary Bytes | Binary Offset |
|-------|-----------------------------|--|---------|--------------|---------------|
| 7     | P-X $\sigma$                | Standard deviation of P-X (m)  | Float   | 4            | H+32          |
| 8     | P-Y $\sigma$                | Standard deviation of P-Y (m)  | Float   | 4            | H+36          |
| 9     | P-Z $\sigma$                | Standard deviation of P-Z (m)  | Float   | 4            | H+40          |
| 10    | V-sol status                | Solution status, see <i>Table 73: Solution Status</i> on page 419  | Enum    | 4            | H+44          |
| 11    | vel type                    | Velocity type, see <i>Table 74: Position or Velocity Type</i> on page 420  | Enum    | 4            | H+48          |
| 12    | V-X                         | Velocity vector along X-axis (m/s)   | Double  | 8            | H+52          |
| 13    | V-Y                         | Velocity vector along Y-axis (m/s)   | Double  | 8            | H+60          |
| 14    | V-Z                         | Velocity vector along Z-axis (m/s)   | Double  | 8            | H+68          |
| 15    | V-X $\sigma$                | Standard deviation of V-X (m/s)  | Float   | 4            | H+76          |
| 16    | V-Y $\sigma$                | Standard deviation of V-Y (m/s)  | Float   | 4            | H+80          |
| 17    | V-Z $\sigma$                | Standard deviation of V-Z (m/s)  | Float   | 4            | H+84          |
| 18    | stn ID                      | Base station identification  | Char[4] | 4            | H+88          |
| 19    | V-latency                   | A measure of the latency in the velocity time tag in seconds. It should be subtracted from the time to give improved results | Float   | 4            | H+92          |
| 20    | diff_age                    | Differential age in seconds  | Float   | 4            | H+96          |
| 21    | sol_age                     | Solution age in seconds  | Float   | 4            | H+100         |
| 22    | #SVs                        | Number of satellites tracked   | Uchar   | 1            | H+104         |
| 23    | #solnSVs                    | Number of satellite vehicles used in solution  | Uchar   | 1            | H+105         |
| 24    | #ggL1                       | Number of GPS plus GLONASS plus BDS L1/B1 used in solution   | Uchar   | 1            | H+106         |
| 25    | #solnMultiSVs               | Number of satellites with L1/E1/B1 signals used in solution  | Uchar   | 1            | H+107         |
| 26    | Reserved                    |  | Char    | 1            | H+108         |
| 27    | ext sol stat                | Extended solution status (see <i>Table 77: Extended Solution Status</i> on page 423)   | Hex     | 1            | H+109         |
| 28    | Galileo and BeiDou sig mask | Galileo and BeiDou signals used mask (see <i>Table 76: Galileo and BeiDou Signal-Used Mask</i> on page 423)                  | Hex     | 1            | H+110         |

| Field | Field type               | Description   | Format | Binary Bytes | Binary Offset |
|-------|--------------------------|---|--------|--------------|---------------|
| 29    | GPS and GLONASS sig mask | GPS and GLONASS signals used mask (see <i>Table 75: GPS and GLONASS Signal-Used Mask</i> on page 422) | Hex    | 1            | H+111         |
| 30    | xxxx                     | 32-bit CRC (ASCII and Binary only)  | Hex    | 4            | H+112         |
| 31    | [CR][LF]                 | Sentence terminator (ASCII only)  | -      | -            | -             |

**Figure 11: The WGS84 ECEF Coordinate System**

BIH - Defined CPT (1984.0)

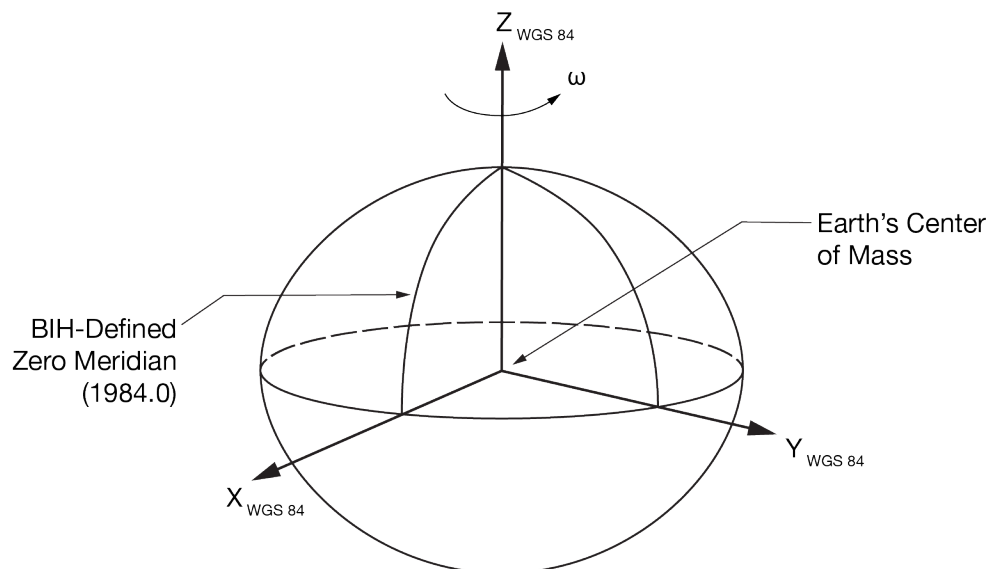
**Table 84: Definitions<sup>1</sup>**

Origin = Earth's center of mass

Z-Axis = Parallel to the direction of the Conventional Terrestrial Pole (CTP) for polar motion, as defined by the Bureau International de l'Heure (BIH) on the basis of the coordinates adopted for the BIH stations.

X-Axis = Intersection of the WGS 84 Reference Meridian Plane and the plane of the CTP's Equator, the Reference Meridian being parallel to the Zero Meridian defined by the BIH on the basis of the coordinates adopted for the BIH stations.

Y-Axis = Completes a right-handed, earth-centered, earth-fixed (ECEF) orthogonal coordinate system, measured in the plane of the CTP Equator, 90° East of the X-Axis.

<sup>1</sup>Analogous to the BIH Defined Conventional Terrestrial System (CTS), or BTS, 1984.0.

## 3.19 BSLNXYZ

### *RTK XYZ baseline*

**Platform: OEM719, OEM729, OEM7500, OEM7700, OEM7720, PwrPak7, HxGN PIM7500**

This log contains the receiver's RTK baseline in ECEF coordinates. The position status field indicates whether or not the corresponding data is valid. See *Figure 11: The WGS84 ECEF Coordinate System* on the previous page for a definition of the ECEF coordinates.

The BSLNXYZ log comes from time-matched base and rover observations such as in the **MATCHEDXYZ** log on page 581.



Asynchronous logs, such as BSLNXYZ, should only be logged ONCHANGED. Otherwise, the most current data is not output when it is available. This is especially true of the ONTIME trigger, which may cause inaccurate time tags to result.

**Message ID: 686**

**Log Type: Asynch**

**Recommended Input:**

```
log bslnxyza onchanged
```

**ASCII Example:**

```
#BSLNXYZA,COM1,0,59.5,FINESTEERING,1419,340033.000,02000040,5b48,2724;  
SOL_COMPUTED,NARROW_INT,0.0012,0.0002,-  
0.0004,0.0080,0.0160,0.0153,"AAAA",12,12,12,12,0,01,0,33*1a8a1b65
```

| Field | Field type     | Data Description  | Format | Binary Bytes | Binary Offset |
|-------|----------------|---|--------|--------------|---------------|
| 1     | BSLNXYZ header | Log header. See <i>Messages</i> on page 25 for more information.          |        | H            | 0             |
| 2     | sol status     | Solution status, see <i>Table 73: Solution Status</i> on page 419         | Enum   | 4            | H             |
| 3     | bsln type      | Baseline type, see <i>Table 74: Position or Velocity Type</i> on page 420 | Enum   | 4            | H+4           |
| 4     | B-X            | X-axis offset (m)   | Double | 8            | H+8           |
| 5     | B-Y            | Y-axis offset (m)   | Double | 8            | H+16          |
| 6     | B-Z            | Z-axis offset (m)   | Double | 8            | H+24          |
| 7     | B-X $\sigma$   | Standard deviation of B-X (m)   | Float  | 4            | H+32          |

| Field | Field type                  | Data Description  | Format  | Binary Bytes | Binary Offset |
|-------|-----------------------------|---|---------|--------------|---------------|
| 8     | B-Y $\sigma$                | Standard deviation of B-Y (m)   | Float   | 4            | H+36          |
| 9     | B-Z $\sigma$                | Standard deviation of B-Z (m)   | Float   | 4            | H+40          |
| 10    | stn ID                      | Base station identification   | Char[4] | 4            | H+44          |
| 11    | #SVs                        | Number of satellites tracked  | Uchar   | 1            | H+48          |
| 12    | #solnSVs                    | Number of satellite vehicles used in solution   | Uchar   | 1            | H+49          |
| 13    | #ggL1                       | Number of GPS plus GLONASS plus BDS L1/B1 used in solution  | Uchar   | 1            | H+50          |
| 14    | #solnMultiSVs               | Number of satellites with L1/E1/B1 signals used in solution   | Uchar   | 1            | H+51          |
| 15    | Reserved                    |   | Uchar   | 1            | H+52          |
| 16    | ext sol stat                | Extended solution status (see <i>Table 77: Extended Solution Status</i> on page 423)                        | Hex     | 1            | H+53          |
| 17    | Galileo and BeiDou sig mask | Galileo and BeiDou signals used mask (see <i>Table 76: Galileo and BeiDou Signal-Used Mask</i> on page 423) | Hex     | 1            | H+54          |
| 18    | GPS and GLONASS sig mask    | GPS and GLONASS signals used mask (see <i>Table 75: GPS and GLONASS Signal-Used Mask</i> on page 422)       | Hex     | 1            | H+55          |
| 19    | xxxx                        | 32-bit CRC (ASCII and Binary only)  | Hex     | 4            | H+56          |
| 20    | [CR][LF]                    | Sentence terminator (ASCII only)  | -       | -            | -             |

## 3.20 CHANCONFIGLIST

### *Channel configuration list*

**Platform: OEM719, OEM729, OEM7500, OEM7700, OEM7720, PwrPak7, HxGN PIM7500**

This log provides the channel configuration list including the number of channels and signal types. If more than one channel configuration is available, then it can be switched using the **SELECTCHANCONFIG** command (see page 319).

**Message ID: 1148**

**Log Type: Polled**

**Recommended Input:**

```
log chanconfiglista once
```

**Abbreviated ASCII Example:**

```
CHANCONFIGLIST COM1 2 73.5 FINESTEERING 1783 585128.718 02000040 d1c0
12793
4 4
6
12 GPSL1L2PL5
2 QZSSL1CAL2CL5
2 SBASL1
10 GLOL1L2
9 GALE1E5AE5BALTBOC
10 BEIDOUB1B2
6
10 GPSL1L2PL2CL5
2 QZSSL1CAL2CL5
2 SBASL1
8 GLOL1L2PL2C
8 GALE1E5AE5BALTBOC
8 BEIDOUB1B2
6
12 GPSL1L2PL5
2 QZSSL1CAL2CL5
2 SBASL1L5
10 GLOL1L2
9 GALE1E5AE5BALTBOC
9 BEIDOUB1B2
6
9 GPSL1L2PL2CL5
2 QZSSL1CAL2CL5
2 SBASL1L5
8 GLOL1L2PL2C
8 GALE1E5AE5BALTBOC
9 BEIDOUB1B2
```



| Field | Field type   | Description   | Format | Binary Bytes | Binary Offset |
|-------|--|---|--------|--------------|---------------|
| 1     | CHANCONFIGLIST header  | Log header. See <i>Messages</i> on page 25 for more information.  |        | H            | 0             |
| 2     | SetInUse   | Current channel configuration being used. For example, if SetInUse is 2 then the second channel configuration listed in this log is the current channel configuration | Ulong  | 4            | H             |
| 3     | #chanconfigs   | Number of channel configurations to follow  | Ulong  | 4            | H+4           |
| 4     | #signaltypes   | Total number of signal types in this channel configuration  | Ulong  | 4            | H+8           |
| 5     | NumChans   | Number of channels for individual signal type   | Ulong  | 4            | H+12          |
| 6     | SignalType   | See <i>Table 85: CHANCONFIGLIST Signal Type</i> below   | Ulong  | 4            | H+16          |
| 7     | Next chanconfig offset = H + 8 + (#chanconfigs * (4 + (#signaltypes * 8))) |   |        |              |               |
| 8     | xxxx   | 32-bit CRC (ASCII and Binary only)  | Hex    | 4            | variable      |
| 9     | [CR][LF]   | Sentence terminator (ASCII only)  | -      | -            | -             |

**Table 85: CHANCONFIGLIST Signal Type**

| Value | Name        | Description                          |
|-------|-------------|--------------------------------------|
| 0     | GPSL1       | GPS L1 C/A signal                    |
| 1     | GPSL1L2     | GPS L1 C/A and L2P(Y) signal         |
| 4     | SBASL1      | SBAS L1 C/A signal                   |
| 5     | GPSL5       | GPS L5 signal                        |
| 6     | GPSL1L2C    | GPS L1 C/A and L2C signal            |
| 7     | GPSL1L2AUTO | GPS L1 C/A and L2 P(Y) or L2C signal |
| 8     | GLOL1L2     | GLONASS L1 C/A and L2P signal        |
| 9     | LBAND       | L-Band signal                        |
| 10    | GLOL1       | GLONASS L1 C/A signal                |

| <b>Value</b> | <b>Name</b>         | <b>Description</b>                         |
|--------------|---------------------|--|
| 11           | GALE1               | Galileo E1 signal                          |
| 12           | GALE5A              | Galileo E5a signal                         |
| 13           | GALE5B              | Galileo E5b signal                         |
| 14           | GALALTBOC           | Galileo E5 AltBOC signal                   |
| 15           | BEIDOUB1            | BeiDou B1 signal                           |
| 16           | GPSL1L2PL2C         | GPS L1 C/A, L2 P(Y), and L2C signal        |
| 17           | GPSL1L5             | GPS L1 C/A and L5 signal                   |
| 18           | SBASL1L5            | SBAS L1 C/A and L5 signal                  |
| 19           | GPSL1L2PL2CL5       | GPS L1 C/A, L2 P(Y), L2C, and L5 signal    |
| 20           | GPSL1L2PL5          | GPS L1 C/A, L2 P(Y), and L5 signal         |
| 21           | GALE1E5AE5B         | Galileo E1, E5a, and E5b signal            |
| 22           | GALE1E5AE5BALTBOC   | Galileo E1, E5a, E5b, and E5 AltBOC signal |
| 23           | GALE1E5A            | Galileo E1 and E5a signal                  |
| 24           | GLOL1L2C            | GLONASS L1 C/A and L2C signal              |
| 25           | GLOL1L2PL2C         | GLONASS L1 C/A, L2 P, and L2C signal       |
| 26           | QZSSL1CA            | QZSS L1 C/A signal                         |
| 27           | QZSSL1CAL2C         | QZSS L1 C/A and L2C signal                 |
| 28           | QZSSL1CAL2CL5       | QZSS L1 C/A, L2C, and L5 signal            |
| 29           | QZSSL1CAL5          | QZSS L1 C/A and L5 signal                  |
| 30           | BEIDOUB1B2          | BeiDou B1 and B2 signal                    |
| 31           | GALE1E5B            | Galileo E1 and E5b signal                  |
| 32           | BEIDOUB1B3          | BeiDou B1, B3                              |
| 33           | BEIDOUB3            | BeiDou B3                                  |
| 34           | BEIDOUB1B2B3        | BeiDou B1, B2 and B3 signal                |
| 35           | GALE1E5AE5BALTBOCE6 | Galileo E1, E5A, E5B, AltBOC, E6           |
| 36           | GPSL1L2PL2CL5L1C    | GPS L1CA, L2P, L2C, L5, L1C                |
| 37           | QZSSL1CAL2CL5L1C    | QZSS L1CA, L2C, L5, L1C                    |
| 38           | QZSSL1CAL2CL5L1CL6  | QZSS L1CA, L2C, L5, L1C, L6                |

| <b>Value</b> | <b>Name</b>    | <b>Description</b>          |
|--------------|----------------|-----------------------------|
| 39           | GLOL1L3        | GLONASS L1CA, L3            |
| 40           | GLOL3          | GLONASS L3                  |
| 41           | GLOL1L2PL2CL3  | GLONASS L1CA, L2P, L2CA, L3 |
| 42           | GPSL1L2PL2CL1C | GPS L1CA, L2P, L2C, L1C     |
| 43           | QZSSL1CAL2CL1C | QZSS L1CA, L2C, L1C         |
| 44           | NAVICL5        | NavIC L5                    |

## 3.21 CLOCKMODEL

### *Current clock model status*

**Platform: OEM719, OEM729, OEM7500, OEM7700, OEM7720, PwrPak7, HxGN PIM7500**

The CLOCKMODEL log contains the current clock model status of the receiver.

Monitoring the CLOCKMODEL log allows you to determine the error in your receiver reference oscillator as compared to the GNSS satellite reference.

All logs report GPS reference time not corrected for local receiver clock error. To derive the closest GPS reference time, subtract the clock offset from the GPS reference time reported. The clock offset can be calculated by dividing the value of the range bias given in field 6 of the CLOCKMODEL log by the speed of light (c).

The following symbols are used throughout this section:

B = range bias (m)

BR = range bias rate (m/s)

SAB = Gauss-Markov process representing range bias error due to satellite clock dither (m)

The standard clock model now used is as follows:

*clock parameters array* = [ B BR SAB]

$$\text{covariance matrix} = \begin{bmatrix} s^2_B & s_B s_{BR} & s_B s_{SAB} \\ s_{BR} s_B & s^2_{BR} & s_{BR} s_{SAB} \\ s_{SAB} s_B & s_{SAB} s_{BR} & s^2_{SAB} \end{bmatrix}$$

**Message ID: 16**

**Log Type: Synch**

**Recommended Input:**

```
log clockmodela ontime 1
```

**ASCII Example:**

```
#CLOCKMODELA,COM1,0,52.0,FINESTEERING,1364,489457.000,82000000,98f9,23
10;VALID,0,489457.000,489457.000,7.11142843e+00,6.110131956e-03,-
4.93391151e+00,3.02626565e+01,2.801659017e-02,-
2.99281529e+01,2.801659017e-02,2.895779736e-02,-1.040643538e-02,-
2.99281529e+01,-1.040643538e-02,3.07428979e+01,2.113,2.710235665e-
02,FALSE*3d530b9a
```



The CLOCKMODEL log can be used to monitor the clock drift of an internal oscillator once the CLOCKADJUST mode has been disabled. Watch the CLOCKMODEL log to see the drift rate and adjust the oscillator until the drift stops.

| Field | Field type        | Description  | Format | Binary Bytes | Binary Offset |
|-------|-------------------|--|--------|--------------|---------------|
| 1     | CLOCKMODEL header | Log header. See <i>Messages</i> on page 25 for more information.   |        | H            | 0             |
| 2     | clock status      | Clock model status as computed from current measurement data, see <i>Table 86: Clock Model Status</i> on the next page | Enum   | 4            | H             |
| 3     | reject            | Number of rejected range bias measurements   | Ulong  | 4            | H+4           |
| 4     | noise time        | GPS reference time of last noise addition  | GPSec  | 4            | H+8           |
| 5     | update time       | GPS reference time of last update  | GPSec  | 4            | H+12          |
| 6     | parameters        | Clock correction parameters (a 1x3 array of length 3), listed left-to-right  | Double | 8            | H+16          |
| 7     |                   |  |        | 8            | H+24          |
| 8     |                   |  |        | 8            | H+32          |
| 9     | cov data          | Covariance of the straight line fit (a 3x3 array of length 9), listed left-to-right by rows                            | Double | 8            | H+40          |
| 10    |                   |  |        | 8            | H+48          |
| 11    |                   |  |        | 8            | H+56          |
| 12    |                   |  |        | 8            | H+64          |
| 13    |                   |  |        | 8            | H+72          |
| 14    |                   |  |        | 8            | H+80          |
| 15    |                   |  |        | 8            | H+88          |
| 16    |                   |  |        | 8            | H+96          |
| 17    | 8                 | H+104  |        |              |               |
| 18    | range bias        | Last instantaneous measurement of the range bias (metres)  | Double | 8            | H+112         |
| 19    | range bias rate   | Last instantaneous measurement of the range bias rate (m/s)  | Double | 8            | H+120         |
| 20    | Reserved          |  | Bool   | 4            | H+128         |
| 21    | xxxx              | 32-bit CRC (ASCII and Binary only)   | Hex    | 4            | H+132         |
| 22    | [CR][LF]          | Sentence terminator (ASCII only)   | -      | -            | -             |

**Table 86: Clock Model Status**

| <b>Clock Status (Binary)</b> | <b>Clock Status (ASCII)</b> | <b>Description</b>                            |
|------------------------------|-----------------------------|---|
| 0                            | VALID                       | The clock model is valid                      |
| 1                            | CONVERGING                  | The clock model is near validity              |
| 2                            | ITERATING                   | The clock model is iterating towards validity |
| 3                            | INVALID                     | The clock model is not valid                  |

## 3.22 CLOCKSTEERING

### *Clock steering status*

**Platform: OEM719, OEM729, OEM7500, OEM7700, OEM7720, PwrPak7, HxGN PIM7500**

The CLOCKSTEERING log is used to monitor the current state of the clock steering process. All oscillators have some inherent drift. By default the receiver attempts to steer the receiver clock to accurately match GPS reference time. If for some reason this is not desired, this behavior can be disabled using the **CLOCKADJUST** command (see page 101).



If the **CLOCKADJUST** command (see page 101) is ENABLED and the receiver is configured to use an external reference frequency (set in the **EXTERNALCLOCK** command (see page 144)), then the clock steering process takes over the VARF output pins and may conflict with a previously entered **FREQUENCYOUT** command (see page 167).

**Message ID: 26**

**Log Type: Asynch**

**Recommended Input:**

```
log clocksteeringa onchanged
```

**ASCII Example:**

```
#CLOCKSTEERINGA,COM1,0,56.5,FINESTEERING,1337,394857.051,02000000,0f61,1984;INTERNAL,SECOND_ORDER,4400,1707.554687500,0.029999999,-2.000000000,-0.224,0.060*0e218bbc
```



To configure the receiver to use an external reference oscillator, see the **EXTERNALCLOCK** command on page 144.

| Field | Field type           | Description  | Format | Binary Bytes | Binary Offset |
|-------|----------------------|--|--------|--------------|---------------|
| 1     | CLOCKSTEERING header | Log header. See <i>Messages</i> on page 25 for more information. |        | H            | 0             |
| 2     | source               | Clock source, see <i>Table 87: Clock Source</i> on the next page | Enum   | 4            | H             |
| 3     | steeringstate        | Steering state, see <i>Table 88: Steering State</i> on page 449  | Enum   | 4            | H+4           |

| Field | Field type | Description   | Format | Binary Bytes | Binary Offset |
|-------|------------|---|--------|--------------|---------------|
| 4     | period     | Period of the FREQUENCYOUT signal used to control the oscillator, refer to the <b>FREQUENCYOUT</b> command on page 167. This value is set using the <b>CLOCKCALIBRATE</b> command (see page 103)  | Ulong  | 4            | H+8           |
| 5     | pulsewidth | Current pulse width of the FREQUENCYOUT signal. The starting point for this value is set using the <b>CLOCKCALIBRATE</b> command (see page 103). The clock steering loop continuously adjusts this value in an attempt to drive the receiver clock offset and drift terms to zero | Double | 8            | H+12          |
| 6     | bandwidth  | The current band width of the clock steering tracking loop in Hz. This value is set using the <b>CLOCKCALIBRATE</b> command (see page 103)  | Double | 8            | H+20          |
| 7     | slope      | The current clock drift change in m/s/bit for a 1 LSB pulse width. This value is set using the <b>CLOCKCALIBRATE</b> command (see page 103)   | Float  | 4            | H+28          |
| 8     | offset     | The last valid receiver clock offset computed (m). It is the same as Field # 18 of the <b>CLOCKMODEL</b> log on page 444  | Double | 8            | H+32          |
| 9     | driftrate  | The last valid receiver clock drift rate received (m/s). It is the same as Field # 19 of the <b>CLOCKMODEL</b> log (see page 444)   | Double | 8            | H+40          |
| 10    | xxxx       | 32-bit CRC (ASCII and Binary only)  | Hex    | 4            | H+48          |
| 11    | [CR][LF]   | Sentence terminator (ASCII only)  | -      | -            | -             |

Table 87: Clock Source

| Binary | ASCII    | Description  |
|--------|----------|--|
| 0      | INTERNAL | The receiver is currently steering its internal VCTCXO using an internal VARF signal     |
| 1      | EXTERNAL | The receiver is currently steering an external oscillator using the external VARF signal |



**Table 88: Steering State**

| Binary | ASCII            | Description   |
|--------|------------------|---|
| 0      | FIRST_ORDER      | Upon start-up, the clock steering task adjusts the VARF pulse width to reduce the receiver clock drift rate to below 1 ms using a 1st order control loop. This is the normal start-up state of the clock steering loop.   |
| 1      | SECOND_ORDER     | Once the receiver has reduced the clock drift to below 1 m/s, it enters a second order control loop and attempts to reduce the receiver clock offset to zero. This is the normal runtime state of the clock steering process.   |
| 2      | CALIBRATE_HIGH   | This state corresponds to when the calibration process is measuring at the "High" pulse width setting.<br><br>The CALIBRATE_HIGH state is only seen if you force the receiver to do a clock steering calibration using the <b>CLOCKCALIBRATE</b> command (see page 103). With the <b>CLOCKCALIBRATE</b> command (see page 103), you can force the receiver to calibrate the slope and center pulse width of the currently selected oscillator, to steer. The receiver measures the drift rate at several "High" and "Low" pulse width settings. |
| 3      | CALIBRATE_LOW    | This state corresponds to when the calibration process is measuring at the "Low" pulse width setting.<br><br>The CALIBRATE_LOW state is only seen if you force the receiver to do a clock steering calibration using the <b>CLOCKCALIBRATE</b> command (see page 103). With the <b>CLOCKCALIBRATE</b> command (see page 103), you can force the receiver to calibrate the slope and center pulse width of the currently selected oscillator, to steer. The receiver measures the drift rate at several "High" and "Low" pulse width settings.   |
| 4      | CALIBRATE_CENTER | This state corresponds to the "Center" calibration process. Once the center has been found, the modulus pulse width, center pulse width, loop bandwidth and measured slope values are saved in NVM and are used from now on for the currently selected oscillator (INTERNAL or EXTERNAL).<br><br>After the receiver has measured the "High" and "Low" pulse width setting, the calibration process enters a "Center calibration" process where it attempts to find the pulse width required to zero the clock drift rate.                       |

## 3.23 DUALANTENNAHEADING

### *Synchronous heading information for dual antenna product*

**Platform: OEM7720**

The heading is the angle from True North of the primary antenna to secondary antenna vector in a clockwise direction.



You must have an ALIGN capable, dual antenna receiver to use this log.

**Message ID: 2042**

**Log Type: Synch**

**Recommended Input:**

```
log dualantennaheadinga ontime 1
```

**ASCII Example:**

```
#DUALANTENNAHEADINGA, UNKNOWN, 0, 66.5, FINESTEERING, 1949, 575614.000, 02000  
000, d426, 32768; SOL_COMPUTED, NARROW_INT, -  
1.000000000, 255.538528442, 0.006041416, 0.0, 0.043859947, 0.052394450, "J56  
X", 24, 18, 18, 17, 04, 01, 00, 33*1f082ec5
```

| Field | Field type                 | Description   | Binary Format | Binary Bytes | Binary Offset |
|-------|----------------------------|---|---------------|--------------|---------------|
| 1     | DUALANTENNA HEADING header | Log header. See <i>Messages</i> on page 25 for more information.                                    | -             | H            | 0             |
| 2     | sol stat                   | Solution status, see <i>Table 73: Solution Status</i> on page 419                                   | Enum          | 4            | H             |
| 3     | pos type                   | Position type, see <i>Table 74: Position or Velocity Type</i> on page 420                           | Enum          | 4            | H+4           |
| 4     | length                     | Baseline length in metres<br>For Z ALIGN Rovers, this field outputs decimal portion of the baseline | Float         | 4            | H+8           |
| 5     | heading                    | Heading in degrees (0° to 359.999°)   | Float         | 4            | H+12          |
| 6     | pitch                      | Pitch (±90 degrees)   | Float         | 4            | H+16          |
| 7     | Reserved                   |   | Float         | 4            | H+20          |
| 8     | hdg std dev                | Heading standard deviation in degrees   | Float         | 4            | H+24          |
| 9     | ptch std dev               | Pitch standard deviation in degrees   | Float         | 4            | H+28          |

| Field | Field type                  | Description   | Binary Format | Binary Bytes | Binary Offset |
|-------|-----------------------------|---|---------------|--------------|---------------|
| 10    | stn ID                      | Station ID string   | Char[4]       | 4            | H+32          |
| 11    | #SVs                        | Number of satellites tracked  | Uchar         | 1            | H+36          |
| 12    | #solnSVs                    | Number of satellites in solution  | Uchar         | 1            | H+37          |
| 13    | #obs                        | Number of satellites above the elevation mask angle   | Uchar         | 1            | H+38          |
| 14    | #multi                      | Number of satellites above the mask angle with L2   | Uchar         | 1            | H+39          |
| 15    | sol source                  | Solution source (see <i>Table 101: Solution Source</i> on page 528)   | Hex           | 1            | H+40          |
| 16    | ext sol stat                | Extended solution status (see <i>Table 77: Extended Solution Status</i> on page 423)                        | Hex           | 1            | H+41          |
| 17    | Galileo and BeiDou sig mask | Galileo and BeiDou signals used mask (see <i>Table 76: Galileo and BeiDou Signal-Used Mask</i> on page 423) | Hex           | 1            | H+42          |
| 18    | GPS and GLONASS sig mask    | GPS and GLONASS signals used mask (see <i>Table 75: GPS and GLONASS Signal-Used Mask</i> on page 422)       | Hex           | 1            | H+43          |
| 19    | xxxx                        | 32-bit CRC (ASCII and Binary only)  | Hex           | 4            | H+44          |
| 20    | [CR][LF]                    | Sentence terminator (ASCII only)  | -             | -            | -             |

## 3.24 ETHSTATUS

### *Current Ethernet status*

**Platform:** OEM729, OEM7700, OEM7720, PwrPak7

This log provides the current status of the Ethernet ports.

**Message ID:** 1288

**Log Type:** Polled

**Recommended Input:**

```
log ethstatusa once
```

**ASCII Example:**

```
#ETHSTATUSA,COM1,0,89.5,FINESTEERING,1609,500138.174,02000000,e89d,6259;1,ETHA,"00-21-66-00-05-A2",100_FULL*98d86b04
```

| Field | Field Type                                  | Description   | Format      | Binary Bytes          | Binary Offset              |
|-------|---|---|-------------|-----------------------|----------------------------|
| 1     | ETHSTATUS header                            | Log header. See <i>Messages</i> on page 25 for more information.          | -           | H                     | 0                          |
| 2     | #of interfaces                              | Number of records to follow   | Ulong       | 4                     | H                          |
| 3     | interface                                   | Name of the Ethernet interface (e.g., ETHA)                               | Enum        | 4                     | H+4                        |
| 4     | MAC address                                 | An identifier assigned to the network adapters or network interface card  | String [18] | variable <sup>a</sup> | H+8                        |
| 5     | interface configuration                     | Current connectivity, speed and duplex settings of the Ethernet interface | Enum        | 4                     | H+26                       |
| 6...  | Next interface = H+4+(# of interfaces * 26) |   |             |                       |                            |
| 7     | xxxx  | 32-bit CRC (ASCII and Binary only)  | Hex         | 4                     | H+4+(# of interfaces * 26) |
| 8     | [CR][LF]                                    | Sentence terminator (ASCII only)  | -           | -                     | -                          |



Refer to the **ETHCONFIG** command (see page 137) for enum values.

<sup>a</sup>In the binary case, each string field needs to be NULL terminated and additional bytes of padding added to maintain 4-byte alignment, up to the maximum defined by the string size. The next defined field starts immediately at the next 4-byte alignment following the NULL.

## 3.25 FILELIST

### *Display the storage media contents*

**Platform: OEM719, OEM729, OEM7500, OEM7700, OEM7720, PwrPak7, HxGN PIM7500**

Use this log to display the root directory of the active media. A log is produced for each file and directory in the root directory.

The active media is set with the **FILEMEDIACONFIG** command on page 152.

**Message ID: 2100**

**Log Type: Asynch**

**Recommended Input:**

```
log filelista
```

**ASCII Example:**

```
#FILELISTA,COM1,0,95.0,UNKNOWN,0,77428.011,024c4009,e8c9,32768;USBSTIC
K,0,20161117,104430,"blah.txt"*a212a600
```

```
#FILELISTA,COM1,1,94.5,UNKNOWN,0,77428.011,024c4009,e8c9,32768;USBSTIC
K,0,19700101,0,"BMHR15470145U_1930_501232.LOG"*d12f9c46
```

| Field | Field Type        | Description   | Format | Binary Bytes | Binary Offset |
|-------|-------------------|---|--------|--------------|---------------|
| 1     | FILELIST header   | Log header. See <i>Messages</i> on page 25 for more information.                | -      | H            | 0             |
| 2     | MassStorageDevice | Mass Storage Device<br>See <i>Table 90: Mass Storage Device</i> on page 456     | Enum   | 4            | H             |
| 3     | FileType          | The type of entry for this log. See <i>Table 89: File Type</i> on the next page | Enum   | 4            | H+4           |
| 4     | FileSize          | File Size (in Bytes)  | Ulong  | 4            | H+8           |
| 5     | ChangeDate        | Date of the last change   | Ulong  | 4            | H+12          |
| 6     | ChangeTime        | Time of last change   | Ulong  | 4            | H+16          |
| 7     | FileName          | Name of the file or directory File Name STRING Variable H + 20                  | String | Variable     | H+20          |
| 8     | xxxx              | 32-bit CRC (ASCII and Binary only)  | Hex    | 4            | Variable      |
| 9     | [CR][LF]          | Sentence terminator (ASCII only)  | -      | -            | -             |

**Table 89: File Type**

| Binary | ASCII | Description  |
|--------|-------|--|
| 0      | NONE  | Indicates there are no entries in the selected media |
| 1      | FILE  | File   |
| 2      | DIR   | Directory  |



When there no files or directories on the specified media, a single **FILELIST** log is output with **FileType** set to *NONE* and file information set to *0* and empty strings.

## 3.26 FILESTATUS

*Displays the state of the data log file*

**Platform: OEM719, OEM729, OEM7500, OEM7700, OEM7720, PwrPak7, HxGN PIM7500**

Use this log to display the current state of the data log file. Typically the **FILESTATUS** log is used to determine if the log file is open for writing or closed. However, it also shows any error that has occurred.

**Message ID: 2127**

**Log Type: Asynch**

**Recommended Input:**

```
log filestatusa
```

**ASCII Example**

```
#FILESTATUSA,USB3,0,75.0,FINESTEERING,1983,171080.615,02104020,4dbd,14434;INTERNAL_FLASH,CLOSED,"",0,14039057,15754462,""*7de99c77
```

| Field | Field Type             | Description  | Format            | Binary Bytes              | Binary Offset |
|-------|------------------------|--|-------------------|---------------------------|---------------|
| 1     | FILESTATUS Header      | Log header. See <i>Messages</i> on page 25 for more information.                           | -                 | H                         | 0             |
| 2     | MassStorageDevice      | The type of recording device<br>See <i>Table 90: Mass Storage Device</i> on the next page. | Enum              | 4                         | H             |
| 3     | FileStatus             | File status<br>See <i>Table 91: File Status</i> on the next page.                          | Enum              | 4                         | H+4           |
| 4     | FileName               | Filename of the log file   | Fixed UCHAR Array | MAX_FILENAME_LENGTH (MFL) | H+8           |
| 5     | FileSize               | File Size (bytes)  | Ulong             | 4                         | H+MFL+8       |
| 6     | MediaRemainingCapacity | Remaining capacity on the storage media (kb)   | Ulong             | 4                         | H+MFL+12      |

| Field | Field Type         | Description                              | Format | Binary Bytes | Binary Offset |
|-------|--------------------|--|--------|--------------|---------------|
| 7     | MediaTotalCapacity | Total capacity of the storage media (kb) | Ulong  | 4            | H+MFL+16      |
| 8     | ErrorMsg           | Error Message                            | String | Variable     | H+MFL+20      |
| 9     | xxxx               | 32-bit CRC (ASCII and Binary only)       | Hex    | 4            | Variable      |
| 10    | [CR][LF]           | Sentence terminator (ASCII only)         | -      | -            | -             |

**Table 90: Mass Storage Device**

| Binary | ASCII          | Description             |
|--------|----------------|-------------------------|
| 1      | USBSTICK       | USB mass storage device |
| 2      | RAMDRIVE       | -                       |
| 3      | NO_STORAGE     | No mass storage         |
| 4      | INTERNAL_FLASH | Internal eMMC flash     |

**Table 91: File Status**

| Binary | ASCII   | Description                           |
|--------|---------|---------------------------------------|
| 0      | OPEN    | Log file is open                      |
| 1      | CLOSED  | Log file is closed                    |
| 2      | BUSY    |                                       |
| 3      | ERROR   | An error has occurred                 |
| 4      | COPY    |                                       |
| 5      | PENDING | Operation during initialization state |



## 3.27 FILESYSTEMCAPACITY

*Displays storage capacity available*

**Platform: OEM719, OEM729, OEM7500, OEM7700, OEM7720, PwrPak7, HxGN PIM7500**

Use this log to check the amount of storage capacity available in both the internal and external storage.

**Message ID: 2137**

**Log Type: Polled**

**Recommended Input:**

```
log filesystemcapacity
```

**Abbreviated ASCII Example:**

```
<FILESYSTEMCAPACITY COM1 0 92.0 UNKNOWN 0 2736.008 0244c009 fded 32768
<      2
<      USBSTICK 31546671104 688128
<      INTERNAL_FLASH 14735147008 12288
```

**ASCII Example:**

```
#FILESYSTEMCAPACITYA,COM1,0,92.0,UNKNOWN,0,2767.008,0244c009,fded,32768;2,USBSTICK,31546671104,688128,INTERNAL_FLASH,14735147008,12288*8a8d384b
```



The INTERNAL\_FLASH is only present on the PwrPak7.

| Field | Field Type                | Description  | Format | Binary Bytes | Binary Offset |
|-------|---------------------------|--|--------|--------------|---------------|
| 1     | FILESYSTEMCAPACITY header | Log header. See <i>Messages</i> on page 25 for more information.                                     | -      | H            | 0             |
| 2     | #Dev                      | Number of device with data to follow   | Ulong  | 4            | H             |
| 3     | MassStorageDevice         | File system type (recording device)<br>See <i>Table 90: Mass Storage Device</i> on the previous page | Enum   | 4            | H+4           |
| 4     | TotalStorage              | Total storage on device in bytes   | Ulong  | 8            | H+8           |
| 5     | UsedStorage               | Amount of storage used on the device in bytes  | Ulong  | 8            | H+16          |

| Field | Field Type | Description                                  | Format | Binary Bytes | Binary Offset           |
|-------|------------|--|--------|--------------|-------------------------|
| 6     |            | Next device offset = $H+4+(\#Dev \times 20)$ |        |              |                         |
| 7     | xxxx       | 32-bit CRC (ASCII and Binary only)           | Hex    | 4            | $H+4+(\#Dev \times 20)$ |
| 8     | [CR][LF]   | Sentence terminator (ASCII only)             | -      | -            | -                       |

## 3.28 FILESYSTEMSTATUS

### *Display state of recording media*

**Platform: OEM719, OEM729, OEM7500, OEM7700, OEM7720, PwrPak7, HxGN PIM7500**

This log displays the current state of the recording media. It can be used to determine the state of the file system, such as any mounting errors.



When logging the FILESYSTEMSTATUS log, use the **ONNEW** or **ONCHANGED** log trigger.

**Message ID: 2104**

**Log Type: Asynch**

**Recommended Input:**

```
log filesystemstatusa onchanged
```

**Abbreviated ASCII Example:**

```
<FILESYSTEMSTATUS COM1 1 91.5 UNKNOWN 0 5.387 02000020 143c 32768
<   USBSTICK MOUNTED 3862430 ""
<FILESYSTEMSTATUS COM1 0 91.5 COARSESTEERING 1953 153609.680 02000020
143c 32768
<   INTERNAL_FLASH MOUNTED 14756709 ""
```

| Field | Field Type              | Description   | Format | Binary Bytes | Binary Offset |
|-------|-------------------------|---|--------|--------------|---------------|
| 1     | FILESYSTEMSTATUS header | Log header. See <i>Messages</i> on page 25 for more information.          | -      | H            | 0             |
| 2     | MassStorageDevice       | Recording Device<br>See <i>Table 90: Mass Storage Device</i> on page 456  | Enum   | 4            | H             |
| 3     | MassStorageStatus       | Media Status<br>See <i>Table 92: Mass Storage Status</i> on the next page | Enum   | 4            | H+4           |
| 4     | TotalCapacity           | Media total capacity (in kB)  | Ulong  | 4            | H+8           |
| 5     | ErrorMsg                | Error Message   | String | Variable     | H+12          |
| 6     | xxxx                    | 32-bit CRC (ASCII and Binary only)  | Hex    | 4            | Variable      |
| 7     | [CR][LF]                | Sentence Terminator (ASCII only)  | -      | -            | -             |

**Table 92: Mass Storage Status**

| <b>Binary</b> | <b>ASCII</b> | <b>Description</b>                 |
|---------------|--------------|------------------------------------|
| 0             | UNMOUNTED    | Mass storage unmounted             |
| 1             | MOUNTED      | Mass storage mounted               |
| 2             | BUSY         | Mass storage busy. i.e. formatting |
| 3             | ERROR        | Mounting error                     |
| 4             | MOUNTING     | Mass storage is being mounted      |
| 5             | UNMOUNTING   | Mass storage is being unmounted    |

## 3.29 FILETRANSFERSTATUS

*Display the current state of a file transfer*

**Platform: PwrPak7**

This log contains the current state of a file transfer from the internal memory to a USB stick. This logs also indicates any file transfer errors that may have occurred.

**Message ID: 2101**

**Log Tye: Asynch**

**Recommended Input:**

```
log filetransferstatusa onchanged
```

**ASCII Example:**

```
<FILETRANSFERSTATUS COM1 0 38.0 FINESTEERING 1953 248960.848 02440020
ce81 32768 TRANSFERRING 0 4096035 "NPP714520001W_2017-06-10_01-16-
20.LOG" ""

<FILETRANSFERSTATUS COM1 0 88.5 FINESTEERING 1953 248961.853 02000020
ce81 32768 TRANSFERRING 1138 4096035 "NPP714520001W_2017-06-10_01-16-
20.LOG" ""

<FILETRANSFERSTATUS COM1 0 17.5 FINESTEERING 1953 248962.853 02000020
ce81 32768 TRANSFERRING 2277 4096035 "NPP714520001W_2017-06-10_01-16-
20.LOG" ""

...
```

| Field | Field Type                | Description  | Format | Binary Bytes | Binary Offset |
|-------|---------------------------|--|--------|--------------|---------------|
| 1     | FILETRANSFERSTATUS header | Log header. See <i>Messages</i> on page 25 for more information.                             | -      | H            | 0             |
| 2     | File Transfer Status      | The status of the file transfer. See <i>Table 93: File Transfer Status</i> on the next page. | Enum   | 4            | H             |
| 3     | Total Transferred         | Total amount of data transferred. (kbytes)   | Ulong  | 4            | H+4           |
| 4     | Total Transfer Size       | Total size of the data to transfer. (kbytes)   | Ulong  | 4            | H+8           |
| 5     | Filename                  | Name of the file that is currently transferring.   | String | Variable     | H+16          |
| 6     | Error Msg                 | Error message (if an error occurred)   | String | Variable     | Variable      |

| Field | Field Type | Description                        | Format | Binary Bytes | Binary Offset |
|-------|------------|------------------------------------|--------|--------------|---------------|
| 7     | xxxx       | 32-bit CRC (ASCII and Binary only) | Hex    | 4            | Variable      |
| 8     | [CR][LF]   | Sentence terminator (ASCII only)   | -      | -            | -             |

**Table 93: File Transfer Status**

| Binary Value | ASCII Value  | Description                                  |
|--------------|--------------|--|
| 1            | NONE         | There is no file transfer in progress        |
| 2            | TRANSFERRING | There is an active file transfer             |
| 3            | FINISHED     | The transfer has been successfully completed |
| 4            | ERROR        | An error occurred during the transfer        |
| 5            | CANCELLED    | A user cancelled the active file transfer    |

## 3.30 GALALMANAC

### *Decoded Galileo Almanac*

**Platform: OEM719, OEM729, OEM7500, OEM7700, OEM7720, PwrPak7, HxGN PIM7500**

This log contains the decoded Galileo almanac parameters from Galileo navigation messages. Multiple messages are transmitted, one for each satellite ID with data.

The OEM7 family of receivers automatically save almanacs in their Non-Volatile Memory (NVM), so creating an almanac boot file is not necessary.

**Message ID: 1120**

**Log Type: Asynch**

**Recommended Input:**

```
log galalmanaca onchanged
```

**ASCII Example:**

```
#GALALMANACA,COM1,3,83.5,SATTIME,1769,333371.000,02000020,131f,45362;
19,FALSE,TRUE,0,0,0,0,10,745,332400.000,1.221e-04,-5.486e-09,
2.757e+00,2.038e+00,-1.226e+00,-1.1444e-05,0.000,2.539e-02,-1.457e-02
*5c77f44b
```

```
#GALALMANACA,COM1,2,83.5,SATTIME,1769,333399.000,02000020,131f,45362;
20,FALSE,TRUE,0,0,0,0,10,745,332400.000,1.831e-04,-5.486e-09,
2.757e+00,1.542e+00,-3.1734e-02,4.8084e-03,9.495e-10,2.539e-02,
-1.457e-02*3530e391
```

```
#GALALMANACA,COM1,1,83.5,SATTIME,1769,333939.000,02000020,131f,45362;
11,FALSE,TRUE,0,0,0,0,11,745,333000.000,6.104e-05,-5.120e-09,
6.6412e-01,2.396e+00,-1.032e+00,5.1498e-05,1.091e-11,3.125e-02,
-1.764e-02*afa0f631
```

```
#GALALMANACA,COM1,0,83.5,SATTIME,1769,333941.000,02000020,131f,45362;
12,FALSE,TRUE,0,0,0,0,11,745,333000.000,1.526e-04,-5.120e-09,
6.6412e-01,-2.392e+00,-1.818e+00,6.4850e-05,1.091e-11,3.516e-02,
-1.764e-02*ef41e1b2
```



The speed at which the receiver locates and locks onto new satellites is improved if the receiver has approximate time and position, as well as an almanac. This allows the receiver to compute the elevation of each satellite so it can tell which satellites are visible and their Doppler offsets, improving Time to First Fix (TTFF).

| Field | Field Type        | Description  | Format | Binary Bytes | Binary Offset |
|-------|-------------------|--|--------|--------------|---------------|
| 1     | GALALMANAC header | Log header. See <i>Messages</i> on page 25 for more information.                         |        | H            | 0             |
| 2     | SatId             | Satellite ID   | Ulong  | 4            | H             |
| 3     | FNAVReceived      | Indicates FNAV almanac data received   | Bool   | 4            | H+4           |
| 4     | INAVReceived      | Indicates INAV almanac data received   | Bool   | 4            | H+8           |
| 5     | E1BHealth         | E1B health status bits (only valid if INAVReceived is TRUE)                              | Uchar  | 1            | H+12          |
| 6     | E5aHealth         | E5a health status bits (only valid if FNAVReceived is TRUE)                              | Uchar  | 1            | H+13          |
| 7     | E5bHealth         | E5b health status bits (only valid if INAVReceived is TRUE)                              | Uchar  | 1            | H+14          |
| 8     | Reserved          |  | Uchar  | 1            | H+15          |
| 9     | IODa              | Almanac issue of data  | Ulong  | 4            | H+16          |
| 10    | Weeks             | Almanac reference week   | Ulong  | 4            | H+20          |
| 11    | Seconds           | Almanac reference time of week (seconds for ASCII, milliseconds for binary)              | GPSec  | 4            | H+24          |
| 12    | Ecc               | Eccentricity (dimensionless)   | Double | 8            | H+28          |
| 13    | OmegaDot          | Rate of right ascension (radians/second)   | Double | 8            | H+36          |
| 14    | Omega0            | Right ascension (radians)  | Double | 8            | H+44          |
| 15    | Omega             | Argument of perigee (radians)  | Double | 8            | H+52          |
| 16    | M0                | Mean anomaly at ref time (radians)   | Double | 8            | H+60          |
| 17    | Af0               | Satellite clock correction bias (seconds)  | Double | 8            | H+68          |
| 18    | Af1               | Satellite clock correction linear (seconds/second)                                       | Double | 8            | H+76          |
| 19    | DeltaRootA        | Difference with respect to the square root of the nominal semi-major axis (sqrt(metres)) | Double | 8            | H+84          |
| 20    | DeltaI            | Inclination at reference time relative to I0 = 56 deg                                    | Double | 8            | H+92          |
| 21    | xxxx              | 32-bit CRC (ASCII and Binary only)   | Hex    | 4            | H+100         |
| 22    | [CR][LF]          | Sentence terminator (ASCII only)   | -      | -            | -             |



## 3.31 GALCLOCK

### *Galileo clock information*

**Platform: OEM719, OEM729, OEM7500, OEM7700, OEM7720, PwrPak7, HxGN PIM7500**

This log contains the Galileo time information.



This log is populated from both the INAV and FNAV messages. Depending on the data source, it is possible that the time in the header of the log is earlier than the time in a previous log. This is expected behavior.

**Message ID: 1121**

**Log Type: Asynch**

**Recommended Input:**

```
log galclocka onchanged
```

**ASCII Example:**

```
#GALCLOCKA,COM1,0,84.5,SATTIME,1769,336845.000,02000020,c6cf,45362;  
8.381903172e-09,-3.5527137e-15,16,259200,233,28,7,16,-3.5216e-09,  
-1.776e-14,345600,41*186e9085
```

| Field | Field Type      | Description  | Format | Binary Bytes | Binary Offset |
|-------|-----------------|--|--------|--------------|---------------|
| 1     | GALCLOCK header | Log header. See <i>Messages</i> on page 25 for more information.                       |        | H            | 0             |
| 2     | A0              | Constant term of polynomial  | Double | 8            | H             |
| 3     | A1              | 1st order term of polynomial   | Double | 8            | H+8           |
| 4     | DeltaTIs        | Leap second count before leap second adjustment  | Long   | 4            | H+16          |
| 5     | Tot             | UTC data reference time of week (seconds)  | Ulong  | 4            | H+20          |
| 6     | WNt             | UTC data reference week number   | Ulong  | 4            | H+24          |
| 7     | WNIsf           | Week number of leap second adjustment  | Ulong  | 4            | H+28          |
| 8     | DN              | Day number at the end of which a leap second adjustment becomes effective              | Ulong  | 4            | H+32          |
| 9     | DeltaTIsf       | Leap second count after leap second adjustment   | Long   | 4            | H+36          |
| 10    | A0g             | Constant term of the polynomial describing the difference between Galileo and GPS time | Double | 8            | H+40          |

---

| <b>Field</b> | <b>Field Type</b> | <b>Description</b>   | <b>Format</b> | <b>Binary Bytes</b> | <b>Binary Offset</b> |
|--------------|-------------------|--|---------------|---------------------|----------------------|
| 11           | A1g               | Rate of change of offset the offset between Galileo and GPS time | Double        | 8                   | H+48                 |
| 12           | T0g               | Reference time for GGTO data                                     | Ulong         | 4                   | H+56                 |
| 13           | WN0g              | Week number of GGTO reference                                    | Ulong         | 4                   | H+60                 |
| 14           | xxxx              | 32-bit CRC (ASCII and Binary only)                               | Hex           | 4                   | H+64                 |
| 15           | [CR][LF]          | Sentence terminator (ASCII only)                                 | -             | -                   | -                    |

## 3.32 GALFNAVEPHEMERIS

### *Decoded Galileo FNAV Ephemeris*

**Platform: OEM719, OEM729, OEM7500, OEM7700, OEM7720, PwrPak7, HxGN PIM7500**

The GALFNAVEPHEMERIS log contains the Galileo FNAV ephemeris information. Multiple messages are transmitted, one for each satellite ID with date.

**Message ID: 1310**

**Log Type: Asynch**

**Recommended Input:**

```
log galfnavephemerisa onchanged
```

**ASCII Example:**

```
#GALFNAVEPHEMERISA,COM2,0,82.5,SATTIME,1874,148850.000,02400000,02cd,
32768;22,0,0,0,0,118,122,0,147600,147600,-6.101167919e-01,3.1687e-09,
4.478077171e-04,5.44059147e+03,9.639218456e-01,6.4610e-10,
2.329679501e-01,2.55827293e+00,-5.5577315e-09,1.0207e-06,8.2552e-06,
1.611e+02,2.313e+01,4.0978e-08,-1.8626e-09,1.335504232e-03,
1.768257e-10,0.0,2.561e-09*d02e28ca
```

| Field | Field Type               | Description   | Format | Binary Bytes | Binary Offset |
|-------|--------------------------|---|--------|--------------|---------------|
| 1     | GALFNAV EPHEMERIS header | Log header. See <i>Messages</i> on page 25 for more information.        |        | H            | 0             |
| 2     | SatId                    | Satellite identifier  | Ulong  | 4            | H             |
| 3     | E5aHealth                | E5a health status bits  | Uchar  | 1            | H+4           |
| 4     | E5aDVS                   | E5a data validity statuS  | Uchar  | 1            | H+5           |
| 5     | Reserved                 |   | Uchar  | 1            | H+6           |
| 6     | Reserved                 |   | Uchar  | 1            | H+7           |
| 7     | IODnav                   | Issue of data ephemeris   | Ushort | 2            | H+8           |
| 8     | SISA Index               | Signal in space accuracy (unitless)                                     | Uchar  | 1            | H+10          |
| 9     | Reserved                 |   | Uchar  | 1            | H+11          |
| 10    | T0e                      | Ephemeris reference time (s)  | Ulong  | 4            | H+12          |
| 11    | T0c                      | Clock correction data reference time of week from the F/NAV message (s) | Ulong  | 4            | H+16          |

| Field | Field Type | Description  | Format | Binary Bytes | Binary Offset |
|-------|------------|--|--------|--------------|---------------|
| 12    | M0         | Mean anomaly at ref time (radians)   | Double | 8            | H+20          |
| 13    | DeltaN     | Mean motion difference (radians/s)   | Double | 8            | H+28          |
| 14    | Ecc        | Eccentricity (unitless)  | Double | 8            | H+36          |
| 15    | RootA      | Square root of semi-major axis   | Double | 8            | H+44          |
| 16    | I0         | Inclination angle at ref time (radians)  | Double | 8            | H+52          |
| 17    | IDot       | Rate of inclination angle (radians/s)  | Double | 8            | H+60          |
| 18    | Omega0     | Longitude of ascending node of orbital plane at weekly epoch (radians)                 | Double | 8            | H+68          |
| 19    | Omega      | Argument of perigee (radians)  | Double | 8            | H+76          |
| 20    | OmegaDot   | Rate of right ascension (radians/s)  | Double | 8            | H+84          |
| 21    | Cuc        | Amplitude of the cosine harmonic correction term to the argument of latitude (radians) | Double | 8            | H+92          |
| 22    | Cus        | Amplitude of the sine harmonic correction term to the argument of latitude (radians)   | Double | 8            | H+100         |
| 23    | Crc        | Amplitude of the cosine harmonic correction term to the orbit radius (m)               | Double | 8            | H+108         |
| 24    | Crs        | Amplitude of the sine harmonic correction term to the orbit radius (m)                 | Double | 8            | H+116         |
| 25    | Cic        | Amplitude of the cosine harmonic correction term to the angle of inclination (radians) | Double | 8            | H+124         |
| 26    | Cis        | Amplitude of the sine harmonic correction term to the angle of inclination (radians)   | Double | 8            | H+132         |
| 27    | Af0        | SV clock bias correction coefficient from the F/NAV message (s)                        | Double | 8            | H+140         |
| 28    | Af1        | SV clock drift correction coefficient from the F/NAV message (s/s)                     | Double | 8            | H+148         |
| 29    | Af2        | SV clock drift rate correction coefficient from the F/NAV message (s/s <sup>2</sup> )  | Double | 8            | H+156         |
| 30    | E1E5aBGD   | E1, E5a broadcast group delay  | Double | 8            | H+164         |
| 31    | xxxx       | 32-bit CRC (ASCII and Binary only)   | Hex    | 4            | H+172         |
| 32    | [CR][LF]   | Sentence terminator (ASCII only)   | -      | -            | -             |

## 3.33 GALFNAVRAWPAGE

### *Raw Galileo FNAV page data*

**Platform: OEM719, OEM729, OEM7500, OEM7700, OEM7720, PwrPak7, HxGN PIM7500**

This log contains the raw Galileo FNAV page data.

**Message ID: 1413**

**Log Type: Asynch**

**Recommended Input:**

```
log galfnavrpagea onchanged
```

**ASCII Example:**

```
#GALFNAVRAWPAGEA,USB3,0,85.0,SATTIME,1680,434410.000,02000008,d4fb,
43274;56,11,0b818df50ad5ffc151001baffdaa04d5dae655e17affc8a41a83aa
*5955b14d
```

| Field | Field Type            | Description  | Format  | Binary Bytes | Binary Offset |
|-------|-----------------------|--|---------|--------------|---------------|
| 1     | GALFNAVRAWPAGE header | Log header. See <i>Messages</i> on page 25 for more information. |         | H            | 0             |
| 2     | SigChanNum            | Signal channel providing the data                                | Ulong   | 4            | H             |
| 3     | SatId                 | SVID of transmitting satellite                                   | Ulong   | 4            | H+4           |
| 4     | RawFrameData          | Raw F/NAV page (214 bits). Does not include CRC or Tail bits     | Hex[27] | 27           | H+8           |
| 5     | xxxx                  | 32-bit CRC (ASCII and Binary only)                               | Hex     | 4            | H+35          |
| 6     | [CR][LF]              | Sentence terminator (ASCII only)                                 | -       | -            | -             |

## 3.34 GALINAVEPHEMERIS

### *Decoded Galileo INAV Ephemeris*

**Platform: OEM719, OEM729, OEM7500, OEM7700, OEM7720, PwrPak7, HxGN PIM7500**

The GALINAVEPHEMERIS log contains the Galileo INAV ephemeris information. Multiple messages are transmitted, one for each SVID with date.

**Message ID: 1309**

**Log Type: Asynch**

**Recommended Input:**

```
log galinavephemerisa onchanged
```

**ASCII Example:**

```
#GALINAVEPHEMERISA,COM1,10,82.0,SATTIME,1930,494134.000,02000020,dbE9,
32768;1,0,0,0,0,0,0,0,0,54,107,1,493200,493200,2.98962614e+00,
2.7990e-09,1.763084438e-04,5.44061901e+03,9.996620695e-01,-2.8608e-10,
-2.52251354e+00,-1.37786826e+00,-5.7041662e-09,-3.7253e-09,3.8184e-06,
2.773e+02,4.6875e-01,-7.0781e-08,4.6566e-08,3.960891627e-05,
-9.904966e-12,0.0,-6.752e-09,-7.683e-09*b575a8b9
```

```
#GALINAVEPHEMERISA,COM1,9,82.0,SATTIME,1930,511405.000,02000020,dbE9,
32768;2,0,0,0,0,0,0,0,0,81,107,3,509400,509400,1.23345967e+00,
2.9637e-09,2.852674806e-04,5.44061650e+03,9.996659901e-01,-2.3537e-10,
-2.52264339e+00,-7.551901559e-01,-5.8113135e-09,5.2713e-07,2.4810e-06,
3.021e+02,1.034e+01,-1.3039e-08,1.8626e-09,-2.745073289e-07,
1.705303e-13,0.0,-8.149e-09,-9.546e-09*6df98c07
```

```
#GALINAVEPHEMERISA,COM1,8,82.0,SATTIME,1930,511384.000,02000020,dbE9,
32768;8,0,0,0,0,0,0,0,0,83,107,3,510600,510600,1.19121266e+00,
3.0755e-09,1.157049555e-04,5.44062434e+03,9.581430032e-01,-2.9858e-10,
1.66547803e+00,7.075104782e-01,-5.5223729e-09,-1.5851e-06,1.2502e-05,
6.706e+01,-3.447e+01,5.5879e-09,-5.7742e-08,4.641003208e-03,
3.982876e-10,0.0,-1.048e-08,-1.211e-08*99c692a8
```

...

```
#GALINAVEPHEMERISA,COM1,1,82.0,SATTIME,1930,511405.000,02000020,dbE9,
32768;26,0,0,0,0,0,0,0,0,83,107,1,510600,510600,-1.25500637e+00,2.9951
e-09,2.602027962e-04,5.44060480e+03,9.688215634e-01,3.7894e-10,-4.2237
68063e-01,-2.61686286e+00,-5.6309488e-09,-4.0233e-07,8.1658e-06,1.711e
+02,-8.500e+00,-1.3039e-08,-3.1665e-08,5.767530005e-03,4.148148e-10,
0.0,-6.985e-10,-9.313e-10*0e6670f3
```

```
#GALINAVEPHEMERISA,COM1,0,82.0,SATTIME,1930,511405.000,02000020,dbE9,
32768;30,0,0,0,0,0,0,0,0,83,107,1,510600,510600,-2.836817871e-01,
2.9558e-09,2.358634956e-04,5.44061465e+03,9.972253278e-01,-1.9894e-10,
-2.51793093e+00,1.101770916e-01,-5.7991701e-09,7.0594e-07,2.4680e-06,
3.045e+02,1.675e+01,-1.8626e-08,5.0291e-08,4.957979254e-03,
3.988703e-10,0.0,-4.889e-09,-5.821e-09*4513b897
```

| Field | Field Type               | Description   | Format | Binary Bytes | Binary Offset |
|-------|--------------------------|---|--------|--------------|---------------|
| 1     | GALINAV EPHEMERIS header | Log Header  |        | H            | 0             |
| 2     | SatId                    | Satellite identifier  | Ulong  | 4            | H             |
| 3     | E5bHealth                | E5b health status bits  | Uchar  | 1            | H+4           |
| 4     | E5bDVS                   | E5b data validity status  | Uchar  | 1            | H+5           |
| 5     | Reserved                 |   | Uchar  | 1            | H+6           |
| 6     | Reserved                 |   | Uchar  | 1            | H+7           |
| 7     | E1bHealth                | E1b health status bits  | Uchar  | 1            | H+8           |
| 8     | E1bDVS                   | E1b data validity status  | Uchar  | 1            | H+9           |
| 9     | Reserved                 |   | Uchar  | 1            | H+10          |
| 10    | Reserved                 |   | Uchar  | 1            | H+11          |
| 11    | IODnav                   | Issue of data ephemeris   | Ushort | 2            | H+12          |
| 12    | SISA Index               | Signal in space accuracy (unitless)   | Uchar  | 1            | H+14          |
| 13    | INAV Source              | Identifies the source signal:<br>0 = Unknown<br>1 = E1b<br>2 = E5b<br>3 = E1b and E5b | Uchar  | 1            | H+15          |
| 14    | T0e                      | Ephemeris reference time (s)  | Ulong  | 4            | H+16          |
| 15    | T0c                      | Clock correction data reference time of week from the I/NAV message (s)               | Ulong  | 4            | H+20          |
| 16    | M0                       | Mean anomaly at ref time (radians)  | Double | 8            | H+24          |
| 17    | DeltaN                   | Mean motion difference (radians/s)  | Double | 8            | H+32          |
| 18    | Ecc                      | Eccentricity (unitless)   | Double | 8            | H+40          |
| 19    | RootA                    | Square root of semi-major axis  | Double | 8            | H+48          |
| 20    | I0                       | Inclination angle at ref time (radians)   | Double | 8            | H+56          |
| 21    | IDot                     | Rate of inclination angle (radians/s)   | Double | 8            | H+64          |
| 22    | Omega0                   | Longitude of ascending node of orbital plane at weekly epoch (radians)                | Double | 8            | H+72          |

| Field | Field Type | Description  | Format | Binary Bytes | Binary Offset |
|-------|------------|--|--------|--------------|---------------|
| 23    | Omega      | Argument of perigee (radians)  | Double | 8            | H+80          |
| 24    | OmegaDot   | Rate of right ascension (radians/s)  | Double | 8            | H+88          |
| 25    | Cuc        | Amplitude of the cosine harmonic correction term to the argument of latitude (radians) | Double | 8            | H+96          |
| 26    | Cus        | Amplitude of the sine harmonic correction term to the argument of latitude (radians)   | Double | 8            | H+104         |
| 27    | Crc        | Amplitude of the cosine harmonic correction term to the orbit radius (m)               | Double | 8            | H+112         |
| 28    | Crs        | Amplitude of the sine harmonic correction term to the orbit radius (m)                 | Double | 8            | H+120         |
| 29    | Cic        | Amplitude of the cosine harmonic correction term to the angle of inclination (radians) | Double | 8            | H+128         |
| 30    | Cis        | Amplitude of the sine harmonic correction term to the angle of inclination (radians)   | Double | 8            | H+136         |
| 31    | Af0        | SV clock bias correction coefficient from the I/NAV message (s)                        | Double | 8            | H+144         |
| 32    | Af1        | SV clock drift correction coefficient from the I/NAV message (s/s)                     | Double | 8            | H+152         |
| 33    | Af2        | SV clock drift rate correction coefficient from the I/NAV message (s/s <sup>2</sup> )  | Double | 8            | H+160         |
| 34    | E1E5aBGD   | E1, E5a broadcast group delay  | Double | 8            | H+168         |
| 35    | E1E5bBGD   | E1, E5b broadcast group delay  | Double | 8            | H+176         |
| 36    | xxxx       | 32-bit CRC (ASCII and Binary only)   | Hex    | 4            | H+184         |
| 37    | [CR][LF]   | Sentence terminator (ASCII only)   | -      | -            | -             |



## 3.35 GALINAVRAWWORD

### *Raw Galileo INAV word data*

**Platform: OEM719, OEM729, OEM7500, OEM7700, OEM7720, PwrPak7, HxGN PIM7500**

This log contains the raw Galileo INAV word data.

**Message ID: 1414**

**Log Type: Asynch**

**Recommended Input:**

```
log galinavrawworda onchanged
```

**ASCII Example:**

```
#GALINAVRAWWORDA,USB3,0,84.5,SATTIME,1680,434401.000,02000008,884b,43274;55,11,GALE1,0b81e655e17a26eb5237d7d20088ffc9*dcb4bedb
```

| Field | Field Type            | Description  | Format  | Binary Bytes | Binary Offset |
|-------|-----------------------|--|---------|--------------|---------------|
| 1     | GALINAVRAWWORD header | Log header. See <i>Messages</i> on page 25 for more information.   |         | H            | 0             |
| 2     | SigChanNum            | Signal channel providing data                                      | Ulong   | 4            | H             |
| 3     | SatId                 | Satellite ID of transmitting satellite                             | Ulong   | 4            | H+4           |
| 4     | SignalType            | Signal Type as defined in <i>Table 29: Signal Type</i> on page 124 | Enum    | 4            | H+8           |
| 5     | RawFrameData          | Raw I/NAV word (128 bits)  | Hex[16] | 16           | H+12          |
| 6     | xxxx                  | 32-bit CRC (ASCII and Binary only)                                 | Hex     | 4            | H+28          |
| 7     | [CR][LF]              | Sentence terminator (ASCII only)                                   | -       | -            | -             |

## 3.36 GALIONO

### *Decoded Galileo ionospheric corrections*

**Platform: OEM719, OEM729, OEM7500, OEM7700, OEM7720, PwrPak7, HxGN PIM7500**

This log contains the decoded Galileo ionospheric corrections.

**Message ID: 1127**

**Log Type: Asynch**

**Recommended Input:**

```
log galionoa onchanged
```

**ASCII Example:**

```
#GALIONOA,COM1,0,81.5,SATTIME,1930,512134.000,02000020,d22e,32768;  
6.03e+01,-2.344e-02,-3.9368e-03,0,0,0,0,0*f50fae69
```

| Field | Field Type     | Description   | Format | Binary Bytes | Binary Offset |
|-------|----------------|---|--------|--------------|---------------|
| 1     | GALIONO header | Log header. See <i>Messages</i> on page 25 for more information.          |        | H            | 0             |
| 2     | Ai0            | Effective ionization level 1st order parameter (sfu)                      | Double | 8            | H             |
| 3     | Ai1            | Effective ionization level 2st order parameter (sfu/degree)               | Double | 8            | H+8           |
| 4     | Ai2            | Effective ionization level 3st order parameter (sfu/degree <sup>2</sup> ) | Double | 8            | H+16          |
| 5     | SF1            | Ionospheric disturbance flag for region 1                                 | Uchar  | 1            | H+24          |
| 6     | SF2            | Ionospheric disturbance flag for region 2                                 | Uchar  | 1            | H+25          |
| 7     | SF3            | Ionospheric disturbance flag for region 3                                 | Uchar  | 1            | H+26          |
| 8     | SF4            | Ionospheric disturbance for flag region 4                                 | Uchar  | 1            | H+27          |
| 9     | SF5            | Ionospheric disturbance for flag region 5                                 | Uchar  | 1            | H+28          |
| 10    | xxxx           | 32-bit CRC (ASCII and Binary only)  | Hex    | 4            | H+29          |
| 11    | [CR][LF]       | Sentence terminator (ASCII only)  | -      | -            | -             |

## 3.37 GLMLA

### *NMEA GLONASS Almanac data*

**Platform: OEM719, OEM729, OEM7500, OEM7700, OEM7720, PwrPak7, HxGN PIM7500**

This log outputs almanac data for GLONASS satellites. Multiple sentences are transmitted, one for each satellite.



The following relationships enable translation between the NMEA GLONASS satellite IDs, the NovAtel GLONASS PRN IDs, and the GLONASS slot numbers:

|                           |   |                                |
|---------------------------|---|--------------------------------|
| NMEA GLONASS satellite ID | = | GLONASS slot number + 64       |
| NovAtel GLONASS PRN ID    | = | GLONASS slot number + 37       |
|                           | = | NMEA GLONASS satellite ID - 27 |

**Message ID: 859**

**Log Type: Asynch**

**Recommended Input:**

```
log glmlaa onchanged
```

**ASCII Example:**

```
$GLMLA,16,01,65,1176,07,0496,4c,5ff2,8000,34c05e,0e93e8,04b029,001fa2,
099,213*68
$GLMLA,16,02,66,1176,01,12e3,4c,42cc,8000,34c08e,10fae9,02f48c,00224e,
099,003*64
$GLMLA,16,03,67,1176,8c,08f6,4a,ef4d,8000,34c051,13897b,00d063,001b09,
099,000*63
$GLMLA,16,04,68,1176,06,116b,48,3a00,8000,34c09d,02151f,0e49e8,00226e,
099,222*63
$GLMLA,16,05,70,1176,01,140f,49,45c4,8000,34c0bc,076637,0a3e40,002214,
099,036*37
$GLMLA,16,06,71,1176,05,0306,4c,5133,8000,34c025,09bda7,085d84,001f83,
099,21d*6E
$GLMLA,16,07,72,1176,06,01b1,4c,4c19,8000,34c021,0c35a0,067db8,001fca,
099,047*3D
$GLMLA,16,08,74,1176,84,076b,45,7995,8000,34c07b,104b6d,0e1557,002a38,
099,040*35
$GLMLA,16,09,78,1176,84,066c,46,78cf,8000,34c07b,0663f0,1a6239,0029df,
099,030*38
$GLMLA,16,10,79,1176,80,0afc,45,8506,8000,34c057,08de48,1c44ca,0029d7,
099,000*6B
```

```
$GLMLA,16,11,82,1176,8a,12d3,0f,e75d,8000,34be85,10aea6,1781b7,00235a,099,207*6E
```

```
$GLMLA,16,12,83,1176,03,0866,0f,6c08,8000,34c009,11f32e,18839d,002b22,099,214*36
```

```
$GLMLA,16,13,85,1176,88,01a6,0d,9dc9,8000,34bff8,031887,02da1e,002838,099,242*6D
```

```
$GLMLA,16,14,86,1176,8a,00e1,0e,4b15,8000,34c016,058181,010433,0027f0,099,227*6F
```

```
$GLMLA,16,15,87,1176,03,0383,0f,824c,8000,34bfda,081864,1104ea,002b04,099,00c*60
```

```
$GLMLA,16,16,88,1176,02,0821,0f,8ac8,8000,34c05b,0a8510,12dcb6,002b6f,099,020*3F
```

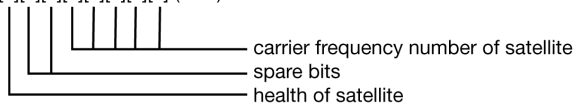

Refer to the GLONASS section of [An Introduction to GNSS](#) available on our website.

| Field | Structure   | Description  | Symbol | Example |
|-------|-------------|--|--------|---------|
| 1     | \$GLMLA     | Log header. See <i>Messages</i> on page 25 for more information.   |        | \$GLMLA |
| 2     | #alm        | Number of NMEA almanac messages in the set   | x.x    | 16      |
| 3     | alm#        | Current message number   | x.x    | 13      |
| 4     | slot        | Slot number for satellite (65-96)<br>The NMEA GLONASS PRN numbers are 64 plus the GLONASS slot number. Current slot numbers are 1 to 24 which give the range 65 to 88. PRN numbers 89 to 96 are available if slot numbers above 24 are allocated to on-orbit spares. | xx     | 85      |
| 5     | N           | Calendar day count within the four year period from the last leap year   | x.x    | 1176    |
| 6     | hlth & freq | Health and frequency for satellite<br>Health and carrier frequency numbers are represented in this 2-character Hex field as:<br>hh = [8][7][6][5][4][3][2][1] (LSB)<br>          | hh     | 88      |
| 7     | ecc         | Eccentricity <sup>1</sup>  | hhhh   | 01a6    |

<sup>1</sup>The LSB of the Hex data field corresponds to the LSB of the word indicated in the Table 4.3 of the GLONASS Interface Control Document, 1995. If the number of available bits in the Hex field is greater than the word, the MSB (upper bits) are unused and filled with zeroes.

| Field | Structure          | Description  | Symbol  | Example  |
|-------|--------------------|--|---------|----------|
| 8     | $\Delta T_{dot}$   | Rate of change of orbital period (s/orbital period <sup>2</sup> ) <sup>1</sup>       | hh      | 0d       |
| 9     | w                  | Argument of perigee (PZ-90.02), in radians <sup>1</sup>                              | hhhh    | 9dc9     |
| 10    | t <sub>16MSB</sub> | Clock offset, in seconds <sup>1</sup>  | hhhh    | 8000     |
| 11    | $\Delta T$         | Correction to the mean value of the Draconian period (s/orbital period) <sup>1</sup> | hhhhhh  | 34bff8   |
| 12    | t <sub>n</sub>     | GLONASS Time of ascending node equator crossing, in seconds <sup>1</sup>             | hhhhhhh | 031887   |
| 13    | l                  | Longitude of ascending node equator crossing (PZ-90.02), in radians <sup>1</sup>     | hhhhhhh | 02da1e   |
| 14    | $\Delta i$         | Correction to nominal inclination, in radians <sup>1</sup>                           | hhhhhhh | 002838   |
| 15    | t <sub>12LSB</sub> | Clock offset, in seconds <sup>1</sup>  | hhh     | 099      |
| 16    | t                  | Coarse value of the time scale shift <sup>1</sup>                                    | hhh     | 242      |
| 17    | xxxx               | 32-bit CRC (ASCII and Binary only)   | Hex     | *6D      |
| 18    | [CR][LF]           | Sentence terminator (ASCII only)   | -       | [CR][LF] |

## 3.38 GLOALMANAC

### *Decoded GLONASS Almanac*

**Platform: OEM719, OEM729, OEM7500, OEM7700, OEM7720, PwrPak7, HxGN PIM7500**

The GLONASS almanac reference time and week are in GPS reference time coordinates. GLONASS ephemeris information is available through the **GLOEPHEMERIS** command (see page 483).

Nominal orbit parameters of the GLONASS satellites are as follows:

- Draconian period - 11 hours 15 minutes 44 seconds (see fields 14 and 15 in the following table)
- Orbit altitude - 19100 km
- Inclination - 64.8 (see field 11)
- Eccentricity - 0 (see field 12)

The OEM7 family of receivers automatically save almanacs in their Non-Volatile Memory (NVM), so creating an almanac boot file is not necessary.



The speed at which the receiver locates and locks onto new satellites is improved if the receiver has approximate time and position, as well as an almanac. This allows the receiver to compute the elevation of each satellite so it can tell which satellites are visible and their Doppler offsets, improving Time to First Fix (TTFF).

**Message ID: 718**

**Log Type: Asynch**

**Recommended Input:**

```
log gloalmanaca onchanged
```

**ASCII Example:**

```
#GLOALMANACA,COM1,0,52.5,SATTIME,1364,410744.000,02000000,ba83,2310;
24,
1364,336832.625,1,2,0,0,2018.625000000,-2.775537500,0.028834045,
0.001000404,2.355427500,-2656.076171875,0.000000000,0.000091553,
1364,341828.437,2,1,0,0,7014.437500000,-3.122226146,0.030814438,
0.004598618,1.650371580,-2656.160156250,0.000061035,0.000095367,
1364,347002.500,3,12,0,0,12188.500000000,2.747629236,0.025376596,
0.002099991,-2.659059822,-2656.076171875,-0.000061035,-0.000198364,
1364,351887.125,4,6,0,0,17073.125000000,2.427596502,0.030895332,
0.004215240,1.438586358,-2656.167968750,-0.000061035,0.000007629,
.
.
```

```

.
1364,364031.187,23,11,0,1,29217.187500000,0.564055522,0.030242192,
0.001178741,2.505278248,-2655.957031250,0.000366211,0.000019073,
1364,334814.000,24,3,0,1,0.000000000,0.000000000,0.000000000,
0.000000000,0.000000000,0.000000000,0.000000000,0.000000000
*4dc981c7

```

| Field | Field type        | Description  | Format | Binary Bytes | Binary Offset |
|-------|-------------------|--|--------|--------------|---------------|
| 1     | GLOALMANAC header | Log header. See <i>Messages</i> on page 25 for more information.                             |        | H            | 0             |
| 2     | #recs             | The number of GLONASS almanac records to follow. Set to zero until almanac data is available | Long   | 4            | H             |
| 3     | week              | GPS reference week, in weeks   | Ulong  | 4            | H+4           |
| 4     | time              | GPS reference time, in milliseconds (binary data) or seconds (ASCII data)                    | GPSec  | 4            | H+8           |
| 5     | slot              | Slot number for satellite, ordinal   | Uchar  | 1            | H+12          |
| 6     | frequency         | Frequency for satellite, ordinal (frequency channels are in the range -7 to +6)              | Char   | 1            | H+13          |
| 7     | sat type          | Satellite type where<br>0 = GLO_SAT<br>1 = GLO_SAT_M (M type)<br>2 = GLO_SAT_K (K type)      | Uchar  | 1            | H+14          |
| 8     | health            | Satellite status where<br>0 = OPERATIONAL<br>1 = MALFUNCTION                                 | Uchar  | 1            | H+15          |
| 9     | TlambdaN          | GLONASS Time of ascending node equator crossing, in seconds                                  | Double | 8            | H+16          |
| 10    | lambdaN           | Longitude of ascending node equator crossing (PZ-90.02), in radians                          | Double | 8            | H+24          |
| 11    | deltaI            | Correction to nominal inclination, in radians  | Double | 8            | H+32          |
| 12    | ecc               | Eccentricity   | Double | 8            | H+40          |
| 13    | ArgPerig          | Argument of perigee (PZ-90.02), in radians   | Double | 8            | H+48          |
| 14    | deltaT            | Correction to the mean value of the Draconian period (s/orbital period)                      | Double | 8            | H+56          |

| Field | Field type                                 | Description   | Format | Binary Bytes | Binary Offset           |
|-------|--|---|--------|--------------|-------------------------|
| 15    | deltaTD                                    | Rate of change of orbital period (s/orbital period <sup>2</sup> ) | Double | 8            | H+64                    |
| 16    | tau  | Clock offset, in seconds  | Double | 8            | H+72                    |
| 17    | Next message offset = H + 4 + (#recs x 76) |   |        |              |                         |
| 18    | xxxx                                       | 32-bit CRC (ASCII and Binary only)                                | Ulong  | 4            | H+4+<br>(76 x<br>#recs) |
| 19    | [CR][LF]                                   | Sentence terminator (ASCII only)                                  | -      | -            | -                       |



## 3.39 GLOCLOCK

### *GLONASS clock information*

**Platform: OEM719, OEM729, OEM7500, OEM7700, OEM7720, PwrPak7, HxGN PIM7500**

This log contains the time difference information between GPS and GLONASS time as well as status flags. The status flags are used to indicate the type of time processing used in the least squares adjustment. GPS and GLONASS time are both based on the Universal Time Coordinated (UTC) time scale with some adjustments. GPS reference time is continuous and does not include any of the leap second adjustments to UTC applied since 1980. The result is that GPS reference time currently leads UTC time by 15 seconds.

GLONASS time applies leap seconds but is also three hours ahead to represent Moscow time. The nominal offset between GPS and GLONASS time is therefore due to the three hour offset minus the leap second offset. As well as the nominal offset, there is a residual offset on the order of nanoseconds which must be estimated in the least squares adjustment. The GLONASS-M satellites broadcasts this difference in the navigation message.

This log also contains information from the GLONASS navigation data relating GLONASS time to UTC.

**Message ID: 719**

**Log Type: Asynch**

**Recommended Input:**

```
log gloclocka onchanged
```

**ASCII Example:**

```
#GLOCLOCKA,COM1,0,54.5,SATTIME,1364,411884.000,02000000,1d44,2310;
0,0.000000000,0.000000000,0,0,-0.000000275,792,-0.000001207,
0.000000000,0.000000000,0*437e9afaf
```

| Field | Field type      | Description  | Format | Binary Bytes | Binary Offset |
|-------|-----------------|--|--------|--------------|---------------|
| 1     | GLOCLOCK header | Log header. See <i>Messages</i> on page 25 for more information. |        | H            | 0             |
| 2     | Reserved        |  | Ulong  | 4            | H             |
| 3     |                 |  | Double | 8            | H+4           |
| 4     |                 |  | Double | 8            | H+12          |

| Field | Field type       | Description   | Format | Binary Bytes   | Binary Offset |
|-------|------------------|---|--------|----------------|---------------|
| 5     | sat type         | Satellite type where<br>0 = GLO_SAT<br>1 = GLO_SAT_M (M type)<br>2 = GLO_SAT_K (K type)   | Uchar  | 1              | H+20          |
| 6     | N <sup>4</sup>   | Four-year interval number starting from 1996  | Uchar  | 1 <sup>1</sup> | H+21          |
| 7     | T <sub>GPS</sub> | Correction to GPS time relative to GLONASS time   | Double | 8              | H+24          |
| 8     | N <sup>A</sup>   | GLONASS calendar day number within a four year period beginning since the leap year, in days  | Ushort | 2 <sup>1</sup> | H+32          |
| 9     | T <sub>C</sub>   | GLONASS time scale correction to UTC(SU) given at beginning of day N <sub>4</sub> , in seconds  | Double | 8              | H+36          |
| 10    | b1               | Beta parameter 1st order term   | Double | 8              | H+44          |
| 11    | b2               | Beta parameter 2nd order term   | Double | 8              | H+52          |
| 12    | Kp               | Kp provides notification of the next expected leap second. For more information, see <i>Table 94: Kp UTC Leap Second Descriptions</i> below | Uchar  | 1              | H+60          |
| 13    | xxxx             | 32-bit CRC (ASCII and Binary only)  | Ulong  | 4              | H+61          |
| 14    | [CR][LF]         | Sentence terminator (ASCII only)  | -      | -              | -             |

**Table 94: Kp UTC Leap Second Descriptions**

| Kp | Information on UTC Leap Second                            |
|----|---|
| 00 | No UTC update for this quarter                            |
| 01 | UTC update of plus 1 second at the end of current quarter |
| 11 | UTC update of minus 1 second at end of current quarter    |

<sup>1</sup>In the binary log case, additional bytes of padding are added to maintain 4-byte alignment.

<sup>2</sup>Based on GLONASS ICD version 5.1, 2008.

## 3.40 GLOEPHEMERIS

### *Decoded GLONASS ephemeris*

**Platform: OEM719, OEM729, OEM7500, OEM7700, OEM7720, PwrPak7, HxGN PIM7500**

This log contains GLONASS ephemeris information. GLONASS ephemerides are referenced to the PZ90.02 geodetic datum. No adjustment between the GPS and GLONASS reference frames are made for positioning. Multiple messages are transmitted, one for each SVID with data.

**Message ID: 723**

**Log Type: Asynch**

**Recommended Input:**

log gloephemerisa onchanged

**Example:**

```
#GLOEPHEMERISA, COM1, 3, 49.0, SATTIME, 1364, 413624.000, 02000000, 6b64, 2310;
43, 8, 1, 0, 1364, 413114000, 10786, 792, 0, 0, 87, 0, 9.0260864257812500e+06,
-6.1145468750000000e+06, 2.2926090820312500e+07, 1.4208841323852539e+03,
2.8421249389648438e+03, 1.9398689270019531e+02, 0.0000000000000000,
-2.79396772384643555e-06, -2.79396772384643555e-06, 2.12404876947402954e
-04, -1.396983862e-08, -3.63797880709171295e-12, 78810, 3, 15, 0, 12*a02ce18b

#GLOEPHEMERISA, COM1, 2, 49.0, SATTIME, 1364, 413626.000, 02000000, 6b64, 2310;
44, 11, 1, 0, 1364, 413116000, 10784, 792, 0, 0, 87, 13, -1.2882617187500000e+06,
-1.9318657714843750e+07, 1.6598909179687500e+07, 9.5813846588134766e+02,
2.0675134658813477e+03, 2.4769935607910156e+03, 2.79396772384643555e-06,
-3.72529029846191406e-06, -1.86264514923095703e-06, 6.48368149995803833e
-05, -4.656612873e-09, 3.63797880709171295e-12, 78810, 3, 15, 3, 28*e2d5ef15

#GLOEPHEMERISA, COM1, 1, 49.0, SATTIME, 1364, 413624.000, 02000000, 6b64, 2310;
45, 13, 0, 0, 1364, 413114000, 10786, 0, 0, 0, 87, 0, -1.1672664062500000e+07,
-2.2678505371093750e+07, 4.8702343750000000e+05, -1.1733341217041016e+02,
1.3844585418701172e+02, 3.5714883804321289e+03, 2.79396772384643555e-06,
-2.79396772384643555e-06, 0.0000000000000000, -4.53162938356399536e-05,
5.587935448e-09, -2.36468622460961342e-11, 78810, 0, 0, 0, 8*c15abfeb

#GLOEPHEMERISA, COM1, 0, 49.0, SATTIME, 1364, 413624.000, 02000000, 6b64, 2310;
59, 17, 0, 0, 1364, 413114000, 10786, 0, 0, 0, 87, 0, -2.3824853515625000e+05,
-1.6590188964843750e+07, 1.9363733398437500e+07, 1.3517074584960938e+03,
-2.2859592437744141e+03, -1.9414072036743164e+03, 1.86264514923095703e-0
6, -3.72529029846191406e-06, -1.86264514923095703e-06, 7.9257413744926452
6e-05, 4.656612873e-09, 2.72848410531878471e-12, 78810, 0, 0, 0, 12*ed7675f5
```

| Field | Field type           | Description  | Format | Binary Bytes | Binary Offset |
|-------|----------------------|--|--------|--------------|---------------|
| 1     | GLO EPHEMERIS header | Log header. See <i>Messages</i> on page 25 for more information.   |        | H            | 0             |
| 2     | sloto                | Slot information offset - PRN identification (Slot + 37). This is also called SLOTO in Connect                 | Ushort | 2            | H             |
| 3     | frequ                | Frequency channel offset for satellite in the range 0 to 20  | Ushort | 2            | H+2           |
| 4     | sat type             | Satellite type where<br>0 = GLO_SAT<br>1 = GLO_SAT_M (M type)<br>2 = GLO_SAT_K (K type)                        | Uchar  | 1            | H+4           |
| 5     | Reserved             |  |        | 1            | H+5           |
| 6     | e week               | Reference week of ephemeris (GPS reference time)   | Ushort | 2            | H+6           |
| 7     | e time               | Reference time of ephemeris (GPS reference time) (ms)  | Ulong  | 4            | H+8           |
| 8     | t offset             | Integer seconds between GPS and GLONASS time. A positive value implies GLONASS is ahead of GPS reference time. | Ulong  | 4            | H+12          |
| 9     | Nt                   | Calendar number of day within 4 year interval starting at Jan 1 of a leap year                                 | Ushort | 2            | H+16          |
| 10    | Reserved             |  |        | 1            | H+18          |
| 11    |                      |  |        | 1            | H+19          |
| 12    | issue                | 15 minute interval number corresponding to ephemeris reference time  | Ulong  | 4            | H+20          |
| 13    | health <sup>a</sup>  | Ephemeris health where<br>0-3 = GOOD<br>4-15 = BAD   | Ulong  | 4            | H+24          |

<sup>a</sup>The last four bits of this field are used to describe the health.

Bit 0-2: Bn

Bit 3: In

All other bits are reserved and set to 0.

| Field | Field type  | Description  | Format | Binary Bytes | Binary Offset |
|-------|-------------|--|--------|--------------|---------------|
| 14    | pos x       | X coordinate for satellite at reference time (PZ-90.02) (metres)   | Double | 8            | H+28          |
| 15    | pos y       | Y coordinate for satellite at reference time (PZ-90.02) (metres)   | Double | 8            | H+36          |
| 16    | pos z       | Z coordinate for satellite at reference time (PZ-90.02) (metres)   | Double | 8            | H+44          |
| 17    | vel x       | X coordinate for satellite velocity at reference time (PZ-90.02) (metres/s)  | Double | 8            | H+52          |
| 18    | vel y       | Y coordinate for satellite velocity at reference time (PZ-90.02) (metres/s)  | Double | 8            | H+60          |
| 19    | vel z       | Z coordinate for satellite velocity at reference time (PZ-90.02), (metres/s)   | Double | 8            | H+68          |
| 20    | LS acc x    | X coordinate for lunisolar acceleration at reference time (PZ-90.02), (metres/s/s)   | Double | 8            | H+76          |
| 21    | LS acc y    | Y coordinate for lunisolar acceleration at reference time (PZ-90.02) (metres/s/s)  | Double | 8            | H+84          |
| 22    | LS acc z    | Z coordinate for lunisolar acceleration at reference time (PZ-90.02) (metres/s/s)  | Double | 8            | H+92          |
| 23    | tau_n       | Correction to the nth satellite time t_n relative to GLONASS time t_c (seconds)  | Double | 8            | H+100         |
| 24    | delta_tau_n | Time difference between navigation RF signal transmitted in L2 sub-band and navigation RF signal transmitted in L1 sub-band by nth satellite (seconds) | Double | 8            | H+108         |
| 25    | gamma       | Frequency correction (seconds/second)  | Double | 8            | H+116         |
| 26    | Tk          | Time of frame start (since start of GLONASS day) (seconds)   | Ulong  | 4            | H+124         |
| 27    | P           | Technological parameter  | Ulong  | 4            | H+128         |
| 28    | Ft          | User range   | Ulong  | 4            | H+132         |
| 29    | age         | Age of data (days)   | Ulong  | 4            | H+136         |
| 30    | Flags       | Information flags, see <i>Table 95: GLONASS Ephemeris Flags Coding</i> on the next page  | Ulong  | 4            | H+140         |
| 31    | xxxx        | 32-bit CRC (ASCII and Binary only)   | Ulong  | 4            | H+144         |
| 32    | [CR][LF]    | Sentence terminator (ASCII only)   | -      | -            | -             |

**Table 95: GLONASS Ephemeris Flags Coding**

| Nibble Number   | Bit            | Description   | Range Values                             | Hex Value |
|-----------------|----------------|---|--|-----------|
| N0              | 0              | P1 Flag - Time interval between adjacent iISSUE (fb) values                     | See Table 96: P1 Flag Range Values below | 00000001  |
|                 | 1              |   |  | 00000002  |
|                 | 2              | P2 Flag - Oddness or Evenness of iISSUE (fb) value                              | 0 = even<br>1 = odd                      | 00000004  |
|                 | 3              | P3 Flag - Number of satellites with almanac information within current subframe | 0 = four<br>1 = five                     | 00000008  |
| N-1 through N-7 | 4<br>...<br>31 | Reserved  |  |           |

**Table 96: P1 Flag Range Values**

| State | Description |
|-------|-------------|
| 00    | 0 minutes   |
| 01    | 30 minutes  |
| 10    | 45 minutes  |
| 11    | 60 minutes  |

## 3.41 GLORAWALM

### *Raw GLONASS Almanac data*

**Platform: OEM719, OEM729, OEM7500, OEM7700, OEM7720, PwrPak7, HxGN PIM7500**

This log contains the raw almanac subframes as received from the GLONASS satellite.

**Message ID: 720**

**Log Type: Asynch**

**Recommended Input:**

```
log glorawalma onchanged
```

**Example:**

```
#GLORAWALMA,COM1,0,44.5,SATTIME,1364,419924.000,02000000,77bb,2310;
1364,419954.069,54,
0563100000a4000000006f,0,
0681063c457a12cc0419be,0,
075ff807e2a69804e0040b,0,
0882067fcd80141692d6f2,0,
09433e1b6676980a40429b,0,
0a838d1bfcb4108b089a8c,0,
0bec572f9c869804f05882,0,
...
06950201e02e13d3819564,0,
07939a4a16fe97fe814ad0,0,
08960561cecc13b0014613,0,
09469a5d70c69802819466,0,
0a170165bed413b704d416,0,
0b661372213697fd41965a,0,
0c18000000000000000006,0,
0d000000000000000000652,0,
0e000000000000000000d0,0*b516623b
```

| Field | Field type       | Description   | Format  | Binary Bytes | Binary Offset |
|-------|------------------|---|---------|--------------|---------------|
| 1     | GLORAWALM header | Log header. See <i>Messages</i> on page 25 for more information.          |         | H            | 0             |
| 2     | week             | GPS reference week, in weeks  | Ulong   | 4            | H             |
| 3     | time             | GPS reference time, in milliseconds (binary data) or seconds (ASCII data) | GPSTime | 4            | H+4           |
| 4     | #recs            | Number of records to follow   | Ulong   | 4            | H+8           |

| Field | Field type                            | Description                        | Format      | Binary Bytes | Binary Offset    |
|-------|---------------------------------------|------------------------------------|-------------|--------------|------------------|
| 5     | string                                | GLONASS data string                | String [11] | 11           | H+12             |
| 6     | Reserved                              |                                    | Uchar       | 1            | H+23             |
| 7     | Next record offset = H+8+(#recs x 12) |                                    |             |              |                  |
| 8     | xxxx                                  | 32-bit CRC (ASCII and Binary only) | Ulong       | 4            | H+12+ (#recsx12) |
| 9     | [CR][LF]                              | Sentence terminator (ASCII only)   | -           | -            | -                |



## 3.42 GLORAWEPHEM

### *Raw GLONASS Ephemeris data*

**Platform: OEM719, OEM729, OEM7500, OEM7700, OEM7720, PwrPak7, HxGN PIM7500**

This log contains the raw ephemeris frame data as received from the GLONASS satellite.

**Message ID: 792**

**Log Type: Asynch**

**Recommended Input:**

```
log glorawephema onchanged
```

**Example:**

```
#GLORAWEPHEMA,COM1,3,47.0,SATTIME,1340,398653.000,02000000,332d,2020;
38,9,0,1340,398653.080,4,0148d88460fc115dbdaf78,0,0218e0033667aec83af
2a5,0,038000b9031e14439c75ee,0,0404f226600000000000065,0*17f3dd17
```

...

```
#GLORAWEPHEMA,COM1,0,47.0,SATTIME,1340,398653.000,02000000,332d,2020;
41,13,0,1340,398653.078,4,0108d812532805bfa1cd2c,0,0208e0a36e8e0952b1
11da,0,03c02023b68c9a32410958,0,0401fda4400000000000002a,0*0b237405
```

| Field | Field type         | Description  | Format      | Binary Bytes | Binary Offset |
|-------|--------------------|--|-------------|--------------|---------------|
| 1     | GLORAWEPHEM header | Log header. See <i>Messages</i> on page 25 for more information.   |             | H            | 0             |
| 2     | sloto              | Slot information offset - PRN identification (Slot + 37). Ephemeris relates to this slot and is also called SLOTO in NovAtel Connect | Ushort      | 2            | H             |
| 3     | freqo              | Frequency channel offset in the range 0 to 20  | Ushort      | 2            | H+2           |
| 4     | sigchan            | Signal channel number  | Ulong       | 4            | H+4           |
| 5     | week               | GPS reference week, in weeks   | Ulong       | 4            | H+8           |
| 6     | time               | GPS reference time, in milliseconds (binary data) or seconds (ASCII data)  | GPSec       | 4            | H+12          |
| 7     | #recs              | Number of records to follow  | Ulong       | 4            | H+16          |
| 8     | string             | GLONASS data string  | String [11] | 11           | H+20          |

---

| Field | Field type                                     | Description                        | Format | Binary Bytes | Binary Offset       |
|-------|--|------------------------------------|--------|--------------|---------------------|
| 9     | Reserved                                       |                                    | Uchar  | 1            | H+31                |
| 10    | Next record offset = $H+20+(\#recs \times 12)$ |                                    |        |              |                     |
| 11    | xxxx   | 32-bit CRC (ASCII and Binary only) | Ulong  | 4            | H+20+<br>(#recsx12) |
| 12    | [CR][LF]                                       | Sentence terminator (ASCII only)   | -      | -            | -                   |

## 3.43 GLORAWFRAME

### *Raw GLONASS frame data*

**Platform: OEM719, OEM729, OEM7500, OEM7700, OEM7720, PwrPak7, HxGN PIM7500**

This log contains the raw GLONASS frame data as received from the GLONASS satellite. Multiple messages are transmitted, one for each SVID with data.

**Message ID: 721**

**Log Type: Asynch**

**Recommended Input:**

```
log glorawframea onchanged
```

**Example:**

```
#GLORAWFRAMEA,COM1,19,53.0,SATTIME,1340,398773.000,02000000,8792,2020;
3,39,8,1340,398773.067,44,44,15,0148dc0b67e9184664cb35,0,
0218e09dc8a3ae8c6ba18d,0,
...
0f00000000000000000000,0*11169f9e
...
#GLORAWFRAMEA,COM1,0,53.0,SATTIME,1340,398713.000,02000000,8792,2020;
1,41,13,1340,398713.077,36,36,15,0108da12532805bfa1cded,0,
0208e0a36e8e0952b111da,0,03c02023b68c9a32410958,0,
...
0f6efb59474697fd72c4e2,0*0a6267c8
```

| Field | Field type         | Description   | Format | Binary Bytes | Binary Offset |
|-------|--------------------|---|--------|--------------|---------------|
| 1     | GLORAWFRAME header | Log header. See <i>Messages</i> on page 25 for more information.  |        | H            | 0             |
| 2     | frame#             | Frame number  | Ulong  | 4            | H             |
| 3     | sloto              | Slot information offset - PRN identification (Slot + 37). Ephemeris relates to this slot and is also called SLOTO in NovAtel Connect. | Ushort | 2            | H+4           |
| 4     | freqo              | Frequency channel offset in the range 0 to 20   | Ushort | 2            | H+6           |
| 5     | week               | GPS Week, in weeks  | Ulong  | 4            | H+8           |
| 6     | time               | GPS Time, in milliseconds (binary data) or seconds (ASCII data)   | GPSec  | 4            | H+12          |

| Field | Field type                              | Description                        | Format         | Binary Bytes | Binary Offset                |
|-------|---|------------------------------------|----------------|--------------|------------------------------|
| 7     | frame decode                            | Frame decoder number               | Ulong          | 4            | H+16                         |
| 8     | sigchan                                 | Signal channel number              | Ulong          | 4            | H+20                         |
| 9     | #recs                                   | Number of records to follow        | Ulong          | 4            | H+24                         |
| 10    | string                                  | GLONASS data string                | String<br>[11] | 11           | H+28                         |
| 11    | Reserved                                |                                    | Uchar          | 1            | H+39                         |
| 12    | Next record offset = H+28+ (#recs x 12) |                                    |                |              |                              |
| 13    | xxxx                                    | 32-bit CRC (ASCII and Binary only) | Ulong          | 4            | H<br>+28+<br>(#recs<br>x 12) |
| 14    | [CR][LF]                                | Sentence terminator (ASCII only)   | -              | -            | -                            |

## 3.44 GLORAWSTRING

### *Raw GLONASS string*

**Platform: OEM719, OEM729, OEM7500, OEM7700, OEM7720, PwrPak7, HxGN PIM7500**

This log contains the raw string data as received from the GLONASS satellite.

**Message ID: 722**

**Log Type: Asynch**

**Recommended Input:**

```
log glorawstringa onchanged
```

**Example:**

```
#GLORAWSTRINGA,COM1,0,51.0,SATTIME,1340,399113.000,02000000,50ac,2020;4,6,061000000000000000000004f,0*5b215fb2
```

| Field | Field type          | Description   | Format  | Binary Bytes | Binary Offset |
|-------|---------------------|---|---------|--------------|---------------|
| 1     | GLORAWSTRING header | Log header. See <i>Messages</i> on page 25 for more information.  |         | H            | 0             |
| 2     | slot                | Slot identification   | Uchar   | 1            | H             |
| 3     | freq                | Frequency channel (frequency channels are in the range -7 to +13) | Char    | 1            | H+1           |
| 4     | string              | GLONASS data string   | Hex[11] | 11           | H+2           |
| 5     | Reserved            |   | Uchar   | 1            | H+13          |
| 6     | xxxx                | 32-bit CRC (ASCII and Binary only)                                | Ulong   | 4            | H+14          |
| 7     | [CR][LF]            | Sentence terminator (ASCII only)                                  | -       | -            | -             |

## 3.45 GPALM

### *Almanac data*

**Platform: OEM719, OEM729, OEM7500, OEM7700, OEM7720, PwrPak7, HxGN PIM7500**

This log outputs raw almanac data for each GPS satellite PRN contained in the broadcast message. A separate record is logged for each PRN, up to a maximum of 32 records. GPALM outputs these messages without waiting for a valid almanac. Instead, it uses a UTC time, calculated with default parameters. In this case, the UTC time status (see the **TIME** log on page 822) is set to WARNING since it may not be one hundred percent accurate. When a valid almanac is available, the receiver uses the real parameters. UTC time is then set to VALID. It takes a minimum of 12.5 minutes to collect a complete almanac following receiver boot-up. In the case of a GLONASS capable receiver, the UTC offset can be determined once the GLONASS ephemeris is decoded, which takes about 50 seconds. If an almanac was stored in NVM, the stored values are reported in the GPALM log once time is set on the receiver.



To obtain copies of ICD-GPS-200, refer to ARINC on our website at [www.nova-tel.com/support/knowledge-and-learning/published-papers-and-documents/standards-and-references/](http://www.nova-tel.com/support/knowledge-and-learning/published-papers-and-documents/standards-and-references/). NMEA contact information is also located there.

**Message ID: 217**

**Log Type: Asynch**

**Recommended Input:**

```
log gpalm onchanged
```

**Example:**

```
$GPALM,28,01,01,1337,00,305a,90,1b9d,fd5b,a10ce9,ba0a5e,2f48f1,cccb76,006,001*27
```

```
$GPALM,28,02,02,1337,00,4aa6,90,0720,fd50,a10c5a,4dc146,d89bab,0790b6,fe4,000*70
```

.

.

.

```
$GPALM,28,24,26,1337,00,878c,90,1d32,fd5c,a10c90,1db6b6,2eb7f5,ce95c8,00d,000*23
```

```
$GPALM,28,25,27,1337,00,9cde,90,07f2,fd54,a10da5,adc097,562da3,6488dd,00e,000*2F
```

```
$GPALM,28,26,28,1337,00,5509,90,0b7c,fd59,a10cc4,a1d262,83e2c0,3003bd,02d,000*78
```

```
$GPALM,28,27,29,1337,00,47f7,90,1b20,fd58,a10ce0,d40a0b,2d570e,221641,122,006*7D
```

\$GPALM,28,28,30,1337,00,4490,90,0112,fd4a,a10cc1,33d10a,81dfc5,3bdb0f,178,004\*28



See the *The NMEA (National Marine Electronics Association)* has defined standards that specify how electronic equipment for marine users communicate. GNSS receivers are part of this standard and the NMEA has defined the format for several GNSS data logs otherwise known as 'sentences'. on page 497 that applies to all NMEA logs.

| Field | Structure    | Description   | Symbol | Example |
|-------|--------------|---|--------|---------|
| 1     | \$GPALM      | Log header. See <i>Messages</i> on page 25 for more information.  |        | \$GPALM |
| 2     | # msg        | Total number of messages logged. Set to zero until almanac data is available  | x.x    | 17      |
| 3     | msg #        | Current message number <sup>1</sup>   | x.x    | 17      |
| 4     | PRN          | Satellite PRN number:<br>GPS = 1 to 32  | xx     | 28      |
| 5     | GPS wk       | GPS reference week number   | x.x    | 653     |
| 6     | SV hlth      | SV health, bits 17-24 of each almanac page <sup>2</sup>   | hh     | 00      |
| 7     | ecc          | e, eccentricity <sup>3</sup><br><div style="border: 1px solid black; padding: 5px; margin: 5px 0;">  A quantity defined for a conic section where e=0 is a circle, e=1 is an ellipse, 0&lt;e&lt;1 is a parabola and e&gt;1 is a hyperbola.         </div> | hhhh   | 3EAF    |
| 8     | alm ref time | to a almanac reference time <sup>3</sup>  | hh     | 87      |
| 9     | incl angle   | (sigma)i, inclination angle <sup>3</sup>  | hhhh   | OD68    |
| 10    | omegadot     | OMEGADOT, rate of right ascension <sup>3</sup>  | hhhh   | FD30    |
| 11    | rt axis      | (A) <sup>1/2</sup> , root of semi-major axis <sup>3</sup>   | hhhhhh | A10CAB  |

<sup>1</sup>Variable length integer, 4-digits maximum from (2) most significant binary bits of Subframe 1, Word 3 reference Table 20-I, ICD-GPS-200, Rev. B, and (8) least significant bits from subframe 5, page 25, word 3 reference Table 20-I, ICD-GPS-200.

<sup>2</sup>Reference paragraph 20.3.3.5.1.3, Table 20-VII and Table 20-VIII, ICD-GPS-200, Rev. B.

<sup>3</sup>Reference Table 20-VI, ICD-GPS-200, Rev. B for scaling factors and units.

| Field | Structure     | Description   | Symbol | Example  |
|-------|---------------|---|--------|----------|
| 12    | omega         | omega, argument of perigee <sup>3</sup><br>A measurement along the orbital path from the ascending node to the point where the SV is closest to the Earth, in the direction of the SV's motion. | hhhhhh | 6EE732   |
| 13    | long asc node | (OMEGA) <sup>o</sup> , longitude of ascension node <sup>3</sup>   | hhhhhh | 525880   |
| 14    | Mo            | Mo, mean anomaly <sup>3</sup>   | hhhhhh | 6DC5A8   |
| 15    | af0           | af0, clock parameter <sup>3</sup>   | hhh    | 009      |
| 16    | af1           | af1, clock parameter <sup>3</sup>   | hhh    | 005      |
| 17    | *xx           | Check sum   | *hh    | *37      |
| 18    | [CR][LF]      | Sentence terminator   |        | [CR][LF] |



## 3.46 GPGGA

### *GPS fix data and undulation*

**Platform: OEM719, OEM729, OEM7500, OEM7700, OEM7720, PwrPak7, HxGN PIM7500**

This log contains time, position and fix related data of the GNSS receiver. See also *Table 98: Position Precision of NMEA Logs* on page 503.

The GPGGA log outputs these messages without waiting for a valid almanac. Instead, it uses a UTC time, calculated with default parameters. In this case, the UTC time status (see the **TIME** log on page 822) is set to WARNING since it may not be one hundred percent accurate. When a valid almanac is available, the receiver uses the real parameters. Then the UTC time status is set to VALID.



The GPGGA log can be customized using the **NMEAFORMAT** command (see page 238).

**Message ID: 218**

**Log Type Synch**

**Recommended Input:**

```
log gpgga ontime 1
```

**Example:**

```
$GPGGA,134658.00,5106.9792,N,11402.3003,W,2,09,1.0,1048.47,M,-16.27,M,08,AAAA*60
```



The NMEA (National Marine Electronics Association) has defined standards that specify how electronic equipment for marine users communicate. GNSS receivers are part of this standard and the NMEA has defined the format for several GNSS data logs otherwise known as 'sentences'.

Each NMEA sentence begins with a '\$' followed by a two-letter prefix identifying the type of sending device (for example 'GP', 'GL' or 'GN'), followed by a sequence of letters that define the type of information contained in the sentence. Data contained within the sentence is separated by commas and the sentence is terminated with a two digit checksum followed by a carriage return/line feed. Here is an example of a NMEA sentence describing time, position and fix related data:

```
$GPGGA,134658.00,5106.9792,N,11402.3003,W,2,09,1.0,1048.47,M,-16.27,M,08,AAAA*60
```

The GPGGA sentence shown above and other NMEA logs are output the same no matter what GNSS receiver is used, providing a standard way to communicate and process GNSS information. For more information about NMEA, see the **NMEATALKER** command on page 241.

| Field | Structure  | Description  | Symbol    | Example                                      |
|-------|------------|--|-----------|--|
| 1     | \$GPGGA    | Log header. See <i>Messages</i> on page 25 for more information.                               |           | \$GPGGA                                      |
| 2     | utc        | UTC time status of position (hours/minutes/seconds/ decimal seconds)                           | hhmmss.ss | 202134.00                                    |
| 3     | lat        | Latitude (DDmm.mm)   | llll.ll   | 5106.9847                                    |
| 4     | lat dir    | Latitude direction (N = North, S = South)  | a         | N  |
| 5     | lon        | Longitude (DDDmm.mm)   | yyyyy.yy  | 11402.2986                                   |
| 6     | lon dir    | Longitude direction (E = East, W = West)   | a         | W  |
| 7     | quality    | refer to <i>Table 97: GPS Quality Indicators</i> on the next page                              | x         | 1  |
| 8     | # sats     | Number of satellites in use. May be different to the number in view                            | xx        | 10   |
| 9     | hdop       | Horizontal dilution of precision   | x.x       | 1.0  |
| 10    | alt        | Antenna altitude above/below mean sea level  | x.x       | 1062.22                                      |
| 11    | a-units    | Units of antenna altitude (M = metres)   | M         | M  |
| 12    | undulation | Undulation - the relationship between the geoid and the WGS84 ellipsoid                        | x.x       | -16.271                                      |
| 13    | u-units    | Units of undulation (M = metres)   | M         | M  |
| 14    | age        | Age of correction data (in seconds)<br>The maximum age reported here is limited to 99 seconds. | xx        | (empty when no differential data is present) |
| 15    | stn ID     | Differential base station ID   | xxxx      | (empty when no differential data is present) |
| 16    | *xx        | Check sum  | *hh       | *48  |
| 17    | [CR][LF]   | Sentence terminator  |           | [CR][LF]                                     |

**Table 97: GPS Quality Indicators**

| Indicator | Description                        |
|-----------|------------------------------------|
| 0         | Fix not available or invalid       |
| 1         | Single point                       |
|           | Converging PPP (TerraStar-L)       |
| 2         | Pseudorange differential           |
|           | Converged PPP (TerraStar-L)        |
|           | Converging PPP (TerraStar-C)       |
| 4         | RTK fixed ambiguity solution       |
| 5         | RTK floating ambiguity solution    |
|           | Converged PPP (TerraStar-C)        |
| 6         | Dead reckoning mode                |
| 7         | Manual input mode (fixed position) |
| 8         | Simulator mode                     |
| 9         | WAAS (SBAS) <sup>1</sup>           |



Refer to the **BESTPOS** log (see page 416) and *Table 78: Supplemental Position Types and NMEA Equivalents* on page 424.

<sup>1</sup>An indicator of 9 has been temporarily set for SBAS (NMEA standard for SBAS not decided yet). This indicator can be customized using the GGAQUALITY command.

## 3.47 GPGGALONG

### *Fix data, extra precision and undulation*

**Platform: OEM719, OEM729, OEM7500, OEM7700, OEM7720, PwrPak7, HxGN PIM7500**

This log contains, time, position, undulation and fix related data of the GNSS receiver. This is output as a GPGGA log but the GPGGALONG log differs from the normal GPGGA log by its extra precision. See also *Table 98: Position Precision of NMEA Logs* on page 503.

The GPGGALONG log outputs these messages without waiting for a valid almanac. Instead, it uses a UTC time, calculated with default parameters. In this case, the UTC time status is set to WARNING since it may not be one hundred percent accurate. When a valid almanac is available, the receiver uses the real parameters. Then the UTC time status is set to VALID.



The GPGGALONG log can be customized using the **NMEAFORMAT** command (see page 238).

**Message ID: 521**

**Log Type: Synch**

**Recommended Input:**

```
log gpggalong ontime 1
```

**Example 1:**

```
$GPGGA,181126.00,5106.9802863,N,11402.3037304,W,7,11,0.9,1048.234,M,-16.27,M,,*51
```

**Example 2:**

```
$GPGGA,134658.00,5106.9802863,N,11402.3037304,W,2,09,1.0,1048.234,M,-16.27,M,08,AAAA
```



See the Note in the **GPGGA** log (see page 497) that applies to all NMEA logs.

| Field | Structure   | Description  | Symbol    | Example      |
|-------|-------------|--|-----------|--------------|
| 1     | \$GPGGALONG | Log header   |           | \$GPGGA      |
| 2     | utc         | UTC time status of position (hours/minutes/seconds/ decimal seconds) | hhmmss.ss | 202126.00    |
| 3     | lat         | Latitude (DDmm.mm)   | IIII.II   | 5106.9847029 |

| Field | Structure  | Description  | Symbol   | Example  |
|-------|------------|--|----------|--|
| 4     | lat dir    | Latitude direction (N = North, S = South)  | a        | N  |
| 5     | lon        | Longitude (DDDmm.mm)   | yyyyy.yy | 11402.2986286  |
| 6     | lon dir    | Longitude direction (E = East, W = West)   | a        | W  |
| 7     | GPS qual   | Refer to <i>Table 97: GPS Quality Indicators</i> on page 499   | x        | 1  |
| 8     | # sats     | Number of satellites in use (00-12). May be different to the number in view                          | xx       | 10   |
| 9     | hdop       | Horizontal dilution of precision   | x.x      | 1.0  |
| 10    | alt        | Antenna altitude above/below msl   | x.x      | 1062.376   |
| 11    | units      | Units of antenna altitude (M = metres)   | M        | M  |
| 12    | undulation | Undulation - the relationship between the geoid and the WGS84 ellipsoid                              | x.x      | -16.271  |
| 13    | u-units    | Units of undulation (M = metres)   | M        | M  |
| 14    | age        | Age of Differential GPS data (in seconds)<br>The maximum age reported here is limited to 99 seconds. | xx       | 10<br>(empty when no differential data is present)   |
| 15    | stn ID     | Differential base station ID, 0000-1023  | xxxx     | AAAA<br>(empty when no differential data is present) |
| 16    | *xx        | Check sum  | *hh      | *48  |
| 17    | [CR][LF]   | Sentence terminator  |          | [CR][LF]   |



Refer to the **BESTPOS** log (see page 416) and *Table 78: Supplemental Position Types and NMEA Equivalents* on page 424.

## 3.48 GPGLL

### *Geographic position*

**Platform: OEM719, OEM729, OEM7500, OEM7700, OEM7720, PwrPak7, HxGN PIM7500**

This log contains latitude and longitude of present vessel position, time of position fix and status.

*Table 98: Position Precision of NMEA Logs* on the next page compares the position precision of selected NMEA logs.

The GPGLL log outputs these messages without waiting for a valid almanac. Instead, it uses a UTC time, calculated with default parameters. In this case, the UTC time status (see the **TIME** log on page 822) is set to WARNING since it may not be one hundred percent accurate. When a valid almanac is available, the receiver uses the real parameters. Then the UTC time status is set to VALID.



If the **NMEATALKER** command (see page 241) is set to AUTO, the talker (the first 2 characters after the \$ sign in the log header) is set to GP (GPS satellites only), GL (GLONASS satellites only) or GN (satellites from both systems) or GA (Galileo satellites only).

**Message ID: 219**

**Log Type: Synch**

**Recommended Input:**

```
log gpgll ontime 1
```

**Example 1 (GPS only):**

```
$GPGLL,5107.0013414,N,11402.3279144,W,205412.00,A,A*73
```

**Example 2 (Combined GPS and GLONASS):**

```
$GNGLL,5107.0014143,N,11402.3278489,W,205122.00,A,A*6E
```



See the Note in the **GPGGA** log (see page 497) that applies to all NMEA logs.

| Field | Structure | Description  | Example       |
|-------|-----------|--|---------------|
| 1     | \$GPGLL   | Log header. See <i>Messages</i> on page 25 for more information. | \$GPGLL       |
| 2     | lat       | Latitude (DDmm.mm)   | 5106.7198674  |
| 3     | lat dir   | Latitude direction (N = North, S = South)                        | N             |
| 4     | lon       | Longitude (DDDmm.mm)   | 11402.3587526 |

| Field | Structure   | Description  | Example   |
|-------|-------------|--|-----------|
| 5     | lon dir     | Longitude direction (E = East, W = West)   | W         |
| 6     | utc         | UTC time status of position (hours/minutes/seconds/decimal seconds)  | 220152.50 |
| 7     | data status | Data status: A = Data valid, V = Data invalid  | A         |
| 8     | mode ind    | Positioning system mode indicator, see <i>Table 99: NMEA Positioning System Mode Indicator</i> on page 516 | A         |
| 9     | *xx         | Check sum  | *1B       |
| 10    | [CR][LF]    | Sentence terminator  | [CR][LF]  |

**Table 98: Position Precision of NMEA Logs**

| NMEA Log  | Latitude<br>(# of decimal places) | Longitude<br>(# of decimal places) | Altitude<br>(# of decimal places) |
|-----------|-----------------------------------|------------------------------------|-----------------------------------|
| GPGGA     | 4                                 | 4                                  | 2                                 |
| GPGGALONG | 7                                 | 7                                  | 3                                 |
| GPGLL     | 7                                 | 7                                  | N/A                               |
| GPRMC     | 7                                 | 7                                  | N/A                               |

## 3.49 GPGRS

### *GPS range residuals for each satellite*

**Platform: OEM719, OEM729, OEM7500, OEM7700, OEM7720, PwrPak7, HxGN PIM7500**

Range residuals can be computed in two ways, and this log reports those residuals. Under mode 0, residuals output in this log are used to update the position solution output in the GPGGGA message. Under mode 1, the residuals are recomputed after the position solution in the GPGGGA message is computed. The receiver computes range residuals in mode 1. An integrity process using GPGRS would also require GPGGGA (for position fix data), GPGSA (for DOP figures) and GPGSV (for PRN numbers) for comparative purposes.

The GPGRS log outputs these messages without waiting for a valid almanac. Instead, it uses a UTC time, calculated with default parameters. In this case, the UTC time status (see the **TIME** log on page 822) is set to WARNING since it may not be one hundred percent accurate. When a valid almanac is available, the receiver uses the real parameters. Then the UTC time status is set to VALID.



1. If the range residual exceeds  $\pm 99.9$ , then the decimal part is dropped. Maximum value for this field is  $\pm 999$ . The sign of the range residual is determined by the order of parameters used in the calculation as follows:

$$\text{range residual} = \text{calculated range} - \text{measured range}$$

2. If the **NMEATALKER** command (see page 241) is set to AUTO, the talker (the first 2 characters after the \$ sign in the log header) is set to GP (GPS satellites only), GL (GLONASS satellites only) or GN (satellites from both systems) or GA (Galileo satellites only).

**Message ID: 220**

**Log Type: Synch**

**Recommended Input:**

```
log gpgrs ontime 1
```

**Example 1 (GPS only):**

```
$GPGRS,142406.00,1,-1.1,-0.1,1.7,1.2,-2.0,-0.5,1.2,-1.2,-0.1,,,*67
```

**Example 2 (Combined GPS and GLONASS):**

```
$GNGRS,143209.00,1,-0.2,-0.5,2.2,1.3,-2.0,-1.3,1.3,-0.4,-1.2,-0.2,,,*72
```

```
$GNGRS,143209.00,1,1.3,-6.7,,,,,,,,,,,,,*73
```



See the Note in the **GPGGGA** log (see page 497) that applies to all NMEA logs.



| Field  | Structure | Description   | Symbol        | Example   |
|--------|-----------|---|---------------|---|
| 1      | \$GPGRS   | Log header. See <i>Messages</i> on page 25 for more information.  |               | \$GPGRS   |
| 2      | utc       | UTC time status of position (hours/minutes/seconds/decimal seconds)   | hhmmss.ss     | 192911.0  |
| 3      | mode      | Mode 0= residuals were used to calculate the position given in the matching GGA line (apriori) (not used by OEM7 receivers)<br>Mode 1= residuals were recomputed after the GGA position was computed (preferred mode) | x             | 1   |
| 4 - 15 | res       | Range residuals for satellites used in the navigation solution. Order matches order of PRN numbers in GPGSA   | x.x,x.x,..... | -13.8,-<br>1.9,11.4,-<br>33.6,0.9,<br>6.9,-<br>12.6,0.3,0.6,<br>-22.3 |
| 16     | *xx       | Check sum   | *hh           | *65   |
| 17     | [CR][LF]  | Sentence terminator   |               | [CR][LF]  |

## 3.50 GPGSA

### *GPS DOP and active satellites*

**Platform: OEM719, OEM729, OEM7500, OEM7700, OEM7720, PwrPak7, HxGN PIM7500**

This log contains GNSS receiver operating mode, satellites used for navigation and DOP values. The GPGSA log outputs these messages without waiting for a valid almanac. Instead, it uses a UTC time, calculated with default parameters. In this case, the UTC time status (see the **TIME** log on page 822) is set to WARNING since it may not be one hundred percent accurate. When a valid almanac is available, the receiver uses the real parameters. Then the UTC time status is set to VALID.



If the **NMEATALKER** command (see page 241) is set to AUTO, the talker (the first 2 characters after the \$ sign in the log header) is set to GP (GPS satellites only), GL (GLONASS satellites only), or GN (satellites from both systems) or GA (Galileo satellites only).

**Message ID: 221**

**Log Type: Synch**

**Recommended Input:**

```
log gpgsa ontime 1
```

**Example 1 (GPS only):**

```
$GPGSA,M,3,17,02,30,04,05,10,09,06,31,12,,,1.2,0.8,0.9*35
```

**Example 2 (Combined GPS and GLONASS):**

```
$GNGSA,M,3,17,02,30,04,05,10,09,06,31,12,,,1.2,0.8,0.9*2B
```

```
$GNGSA,M,3,87,70,,,,,,,,,,,,,1.2,0.8,0.9*2A
```



The DOPs provide a simple characterization of the user satellite geometry. DOP is related to the volume formed by the intersection points of the user satellite vectors, with the unit sphere centered on the user. Larger volumes give smaller DOPs. Lower DOP values generally represent better position accuracy. The role of DOP in GNSS positioning is often misunderstood. A lower DOP value does not automatically mean a low position error. The quality of a GNSS derived position estimate depends upon both the measurement geometry as represented by DOP values and range errors caused by signal strength, ionospheric effects, multipath and so on.



See the Note in the **GPGGA** log (see page 497) that applies to all NMEA logs.

| Field  | Structure | Description  | Symbol      | Example                                 |
|--------|-----------|--|-------------|---|
| 1      | \$GPGSA   | Log header. See <i>Messages</i> on page 25 for more information.   |             | \$GPGSA                                 |
| 2      | mode MA   | A = Automatic 2D/3D<br>M = Manual, forced to operate in 2D or 3D   | M           | M                                       |
| 3      | mode 123  | Mode: 1 = Fix not available; 2 = 2D; 3 = 3D  | x           | 3                                       |
| 4 - 15 | prn       | PRN numbers of satellites used in solution (null for unused fields), total of 12 fields<br>GPS = 1 to 32<br>SBAS = 33 to 64 (add 87 for PRN number)<br>GLO = 65 to 96 <sup>1</sup> | xx,xx,..... | 18,03,13,<br>25,16,<br>24,12,<br>20,,,, |
| 16     | pdop      | Position dilution of precision   | x.x         | 1.5                                     |
| 17     | hdop      | Horizontal dilution of precision   | x.x         | 0.9                                     |
| 18     | vdop      | Vertical dilution of precision   | x.x         | 1.2                                     |
| 19     | *xx       | Check sum  | *hh         | *3F                                     |
| 20     | [CR][LF]  | Sentence terminator  |             | [CR][LF]                                |

<sup>1</sup>The NMEA GLONASS PRN numbers are 64 plus the GLONASS slot number. Current slot numbers are 1 to 24 which give the range 65 to 88. PRN numbers 89 to 96 are available if slot numbers above 24 are allocated to on-orbit spares.

## 3.51 GPGST

### *Pseudorange measurement noise statistics*

**Platform: OEM719, OEM729, OEM7500, OEM7700, OEM7720, PwrPak7, HxGN PIM7500**

This log contains pseudorange measurement noise statistics are translated in the position domain in order to give statistical measures of the quality of the position solution.

This log reflects the accuracy of the solution type used in the **BESTPOS** log (see page 416) and **GPGGA** log (see page 497), except for the RMS field. The RMS field, since it specifically relates to pseudorange inputs, does not represent carrier-phase based positions. Instead it reflects the accuracy of the pseudorange position which is given in the **PSRPOS** log (see page 634).

The GPGST log outputs these messages without waiting for a valid almanac. Instead, it uses a UTC time, calculated with default parameters. In this case, the UTC time status (see the **TIME** log on page 822) is set to WARNING since it may not be one hundred percent accurate. When a valid almanac is available, the receiver uses the real parameters. Then the UTC time status is set to VALID.



If the **NMEATALKER** command (see page 241) is set to AUTO, the talker (the first 2 characters after the \$ sign in the log header) is set to GP (GPS satellites only), GL (GLONASS satellites only) or GN (satellites from both systems) or GA (Galileo satellites only).

**Message ID: 222**

**Log Type: Synch**

**Recommended Input:**

```
log gpgst ontime 1
```

**Example 1 (GPS only):**

```
$GPGST,141451.00,1.18,0.00,0.00,0.0000,0.00,0.00,0.00*6B
```

**Example 2 (Combined GPS and GLONASS):**

```
$GNGST,143333.00,7.38,1.49,1.30,68.1409,1.47,1.33,2.07*4A
```



1. See the Note in the **GPGGA** log (see page 497) that applies to all NMEA logs.
2. Accuracy is based on statistics, reliability is measured in percent. When a receiver can measure height to one metre, this is an accuracy. Usually this is a one sigma value (one SD). A one sigma value for height has a reliability of 68%, that is, the error is less than one metre 68% of the time. For a more realistic accuracy, double the one sigma value (1 m) and the result is 95% reliability (error is less than 2 m 95% of the time). Generally, GNSS heights are 1.5 times poorer than horizontal positions.

As examples of statistics, the GPGST message and NovAtel performance specifications use Root Mean Square (RMS). Specifications may be quoted in CEP:

- RMS - root mean square (a probability level of 68%)
- CEP - circular error probable (the radius of a circle such that 50% of a set of events occur inside the boundary)

| Field | Structure | Description   | Symbol    | Example   |
|-------|-----------|---|-----------|-----------|
| 1     | \$GPGST   | Log header. See <i>Messages</i> on page 25 for more information.  |           | \$GPGST   |
| 2     | utc       | UTC time status of position (hours/minutes/seconds/ decimal seconds)  | hhmmss.ss | 173653.00 |
| 3     | rms       | RMS value of the standard deviation of the range inputs to the navigation process. Range inputs include pseudoranges and DGPS corrections | x.x       | 2.73      |
| 4     | smjr std  | Standard deviation of semi-major axis of error ellipse (m)  | x.x       | 2.55      |
| 5     | smnr std  | Standard deviation of semi-minor axis of error ellipse (m)  | x.x       | 1.88      |
| 6     | orient    | Orientation of semi-major axis of error ellipse (degrees from true north)   | x.x       | 15.2525   |
| 7     | lat std   | Standard deviation of latitude error (m)  | x.x       | 2.51      |
| 8     | lon std   | Standard deviation of longitude error (m)   | x.x       | 1.94      |
| 9     | alt std   | Standard deviation of altitude error (m)  | x.x       | 4.30      |
| 10    | *xx       | Check sum   | *hh       | *6E       |
| 11    | [CR][LF]  | Sentence terminator   |           | [CR][LF]  |

## 3.52 GPGSV

### *GPS satellites in view*

**Platform: OEM719, OEM729, OEM7500, OEM7700, OEM7720, PwrPak7, HxGN PIM7500**

This log contains the number of GPS SVs in view, PRN numbers, elevation, azimuth and SNR value. Four satellites maximum per message. When required, additional satellite data sent in 2 or more messages (a maximum of 9). The total number of messages being transmitted and the current message being transmitted are indicated in the first two fields.

The GPGSV log outputs these messages without waiting for a valid almanac. Instead, it uses a UTC time, calculated with default parameters. In this case, the UTC time status (see the **TIME** log on page 822) is set to WARNING since it may not be one hundred percent accurate. When a valid almanac is available, the receiver uses the real parameters. Then the UTC time status is set to VALID.



1. Satellite information may require the transmission of multiple messages. The first field specifies the total number of messages, minimum value 1. The second field identifies the order of this message (message number), minimum value 1.
2. If the **NMEATALKER** command (see page 241) is set to AUTO, the talker (the first 2 characters after the \$ sign in the log header) is set to GP (GPS satellites only) or GL (GLONASS satellites only) or GN (satellites from both systems) or GA (Galileo satellites only). Each system is output in a separate message.
3. The ID setting in the **NMEATALKER** command (see page 241) controls the satellites reported in this log. If the NMEATALKER ID is set to GP, only GPS satellites are reported in this log. If the NMEATALKER ID is set to AUTO, all satellites in view are reported.
4. A variable number of 'PRN-Elevation-Azimuth-SNR' sets are allowed up to a maximum of four sets per message. Null fields are not required for unused sets when less than four sets are transmitted.

**Message ID: 223**

**Log Type: Synch**

**Recommended Input:**

```
log gpgsv ontime 1
```

**Example (Including GPS and GLONASS sentences):**

```
$GPGSV,3,1,11,18,87,050,48,22,56,250,49,21,55,122,49,03,40,284,47*78
$GPGSV,3,2,11,19,25,314,42,26,24,044,42,24,16,118,43,29,15,039,42*7E
$GPGSV,3,3,11,09,15,107,44,14,11,196,41,07,03,173,*4D
$GLGSV,2,1,06,65,64,037,41,66,53,269,43,88,39,200,44,74,25,051,*64
$GLGSV,2,2,06,72,16,063,35,67,01,253,*66
```



The GPGSV log can be used to determine which GPS satellites are currently available to the receiver. Comparing the information from this log to that in the GPGSA log shows if the receiver is tracking all available satellites.



See also the Note in the **GPGGA** log (see page 497) that applies to all NMEA logs.

| Field    | Structure | Description   | Symbol | Example  |
|----------|-----------|---|--------|----------|
| 1        | \$GPGSV   | Log header. See <i>Messages</i> on page 25 for more information.  |        | \$GPGSV  |
| 2        | # msgs    | Total number of messages (1-9)  | x      | 3        |
| 3        | msg #     | Message number (1-9)  | x      | 1        |
| 4        | # sats    | Total number of satellites in view. May be different than the number of satellites in use (see also the <b>GPGGA</b> log on page 497) | xx     | 09       |
| 5        | prn       | Satellite PRN number<br>GPS = 1 to 32<br>SBAS = 33 to 64 (add 87 for PRN#s)<br>GLO = 65 to 96 <sup>1</sup>                            | xx     | 03       |
| 6        | elev      | Elevation, degrees, 90 maximum  | xx     | 51       |
| 7        | azimuth   | Azimuth, degrees True, 000 to 359   | xxx    | 140      |
| 8        | SNR       | SNR (C/No) 00-99 dB, null when not tracking   | xx     | 42       |
| ...      | ...       | Next satellite PRN number, elev, azimuth, SNR,  |        |          |
| ...      | ...       | ...   |        |          |
| ...      | ...       | Last satellite PRN number, elev, azimuth, SNR,  |        |          |
| variable | *xx       | Check sum   | *hh    | *72      |
| variable | [CR][LF]  | Sentence terminator   |        | [CR][LF] |

<sup>1</sup>The NMEA GLONASS PRN numbers are 64 plus the GLONASS slot number. Current slot numbers are 1 to 24 which give the range 65 to 88. PRN numbers 89 to 96 are available if slot numbers above 24 are allocated to on-orbit spares.

## 3.53 GPHDT

### *NMEA heading log*

**Platform: OEM719, OEM729, OEM7500, OEM7700, OEM7720, PwrPak7, HxGN PIM7500**

This log contains actual vessel heading in degrees True (from True North). See also a description of heading in the **HEADING2** log on page 526. You can also set a standard deviation threshold for this log, see the **HDTOUTTHRESHOLD** command on page 185.



You must have an ALIGN capable receiver to use this log.



The GPHDT log can only be logged using the ONCHANGED trigger. Other triggers, such as ONTIME are not accepted.



If the **NMEATALKER** command (see page 241) is set to AUTO, the talker (the first 2 characters after the \$ sign in the log header) is set to GP (GPS satellites only), GL (GLONASS satellites only) or GN (satellites from both systems) or GA (Galileo satellites only).

**Message ID: 1045**

**Log Type: Asynch**

**Recommended Input:**

```
log gphdt onchanged
```

**Example 1 (GPS only):**

```
$GPHDT,75.5664,T*36
```

**Example 2 (Combined GPS and GLONASS):**

```
$GNHDT,75.5554,T*45
```

| Field | Structure | Description  | Symbol | Example  |
|-------|-----------|--|--------|----------|
| 1     | \$GPHDT   | Log header. See <i>Messages</i> on page 25 for more information. |        | \$GPHDT  |
| 2     | heading   | Heading in degrees   | x.x    | 75.5554  |
| 3     | True      | Degrees True   | T      | T        |
| 4     | *xx       | Check sum  | *hh    | *36      |
| 5     | [CR][LF]  | Sentence terminator  |        | [CR][LF] |



## 3.54 GPHDTDUALANTENNA

### *Synchronous NMEA heading log*

**Platform: OEM7720**

This log contains actual vessel heading in degrees True (from True North). It provide the same information as the **GPHDT** log (see page 512), but with synchronous output.



You must have an ALIGN capable, dual antenna receiver to use this log.



If the **NMEATALKER** command (see page 241) is set to AUTO, the talker (the first 2 characters after the \$ sign in the log header) is set to GP (GPS satellites only), GL (GLONASS satellites only) or GN (satellites from both systems) or GA (Galileo satellites only).

**Message ID: 2045**

**Log Type: Synch**

**Recommended Input:**

```
log gphdtdualantenna ontime 1
```

**Example 1 (GPS only):**

```
$GPHDT,75.5664,T*36
```

**Example 2 (Combined GPS and GLONASS):**

```
$GNHDT,75.5554,T*45
```

| Field | Structure | Description  | Symbol | Example  |
|-------|-----------|--|--------|----------|
| 1     | \$GPHDT   | Log header. See <i>Messages</i> on page 25 for more information. |        | \$GPHDT  |
| 2     | heading   | Heading in degrees   | x.x    | 75.5554  |
| 3     | True      | Degrees True   | T      | T        |
| 4     | *xx       | Check sum  | *hh    | *36      |
| 5     | [CR][LF]  | Sentence terminator  |        | [CR][LF] |

## 3.55 GPRMB

### *Navigation information*

**Platform: OEM719, OEM729, OEM7500, OEM7700, OEM7720, PwrPak7, HxGN PIM7500**

This log contains navigation data from present position to a destination waypoint. The destination is set active by the receiver **SETNAV** command (see page 341).

The GPRMB log outputs these messages without waiting for a valid almanac. Instead, it uses a UTC time, calculated with default parameters. In this case, the UTC time status (see the **TIME** log on page 822) is set to WARNING since it may not be one hundred percent accurate. When a valid almanac is available, the receiver uses the real parameters. Then the UTC time status is set to VALID.

**Message ID: 224**

**Log Type: Synch**

**Recommended Input:**

```
log gprmb ontime 1
```

**Example 1 (GPS only):**

```
$GPRMB,A,5.14,L,FROM,TO,5109.7578000,N,11409.0960000,W,5.1,303.0,-0.0,V,A*6F
```

**Example 2 (Combined GPS and GLONASS):**

```
$GNRMB,A,5.14,L,FROM,TO,5109.7578000,N,11409.0960000,W,5.1,303.0,-0.0,V,A*71
```





If the **NMEATALKER** command (see page 241) is set to AUTO, the talker (the first 2 characters after the \$ sign in the log header) is set to GP (GPS satellites only), GL (GLONASS satellites only) or GN (satellites from both systems) or GA (Galileo satellites only).



See the Note in the **GPGGA** log (see page 497) that applies to all NMEA logs.

| Field | Structure   | Field Description  | Symbol | Example |
|-------|-------------|--|--------|---------|
| 1     | \$GPRMB     | Log header. See <i>Messages</i> on page 25 for more information. |        | \$GPRMB |
| 2     | data status | Data status: A = data valid; V = navigation receiver warning     | A      | A       |

| Field | Structure  | Field Description   | Symbol   | Example       |
|-------|------------|---|----------|---------------|
| 3     | xtrack     | <p>Cross track error</p> <p>Represents the track error from the intended course</p> <div style="border: 1px solid black; padding: 5px; margin: 5px 0;">  If the cross track error exceeds 9.99 NM, displays 9.99.         </div> <div style="border: 1px solid black; padding: 5px; margin: 5px 0;">  One nautical mile (NM) = 1,852 metres.         </div> | x.x      | 5.14          |
| 4     | dir        | <p>Direction to steer to get back on track (L/R)</p> <p>Direction to steer is based on the sign of the crosstrack error, that is,<br/>           L = xtrack error (+)<br/>           R = xtrack error (-)</p>   | a        | L             |
| 5     | origin ID  | Origin waypoint ID <sup>1</sup>   | c--c     | FROM          |
| 6     | dest ID    | Destination waypoint ID <sup>1</sup>  | c--c     | TO            |
| 7     | dest lat   | Destination waypoint latitude (DDmm.mm) <sup>1</sup>  | IIII.II  | 5109.7578000  |
| 8     | lat dir    | Latitude direction (N = North, S = South) <sup>1</sup>  | a        | N             |
| 9     | dest lon   | Destination waypoint longitude (DDDmm.mm) <sup>1</sup>  | yyyyy.yy | 11409.0960000 |
| 10    | lon dir    | Longitude direction (E = East, W = West) <sup>1</sup>   | a        | W             |
| 11    | range      | <p>Range to destination, nautical miles</p> <div style="border: 1px solid black; padding: 5px; margin: 5px 0;">  If the range to destination exceeds 999.9 NM, displays 999.9.         </div>  | x.x      | 5.1           |
| 12    | bearing    | Bearing to destination, degrees True  | x.x      | 303.0         |
| 13    | vel        | Destination closing velocity, knots   | x.x      | -0.0          |
| 14    | arr status | <p>Arrival status:</p> <p>A = perpendicular passed</p> <p>V = destination not reached or passed</p>   | A        | V             |

<sup>1</sup>Fields 5, 6, 7, 8, 9, and 10 are tagged from the **SETNAV** command (see page 341).

| Field | Structure | Field Description  | Symbol | Example  |
|-------|-----------|--|--------|----------|
| 15    | mode ind  | Positioning system mode indicator, see <i>Table 99: NMEA Positioning System Mode Indicator</i> below | a      | A        |
| 16    | *xx       | Check sum  | *hh    | *6F      |
| 17    | [CR][LF]  | Sentence terminator  |        | [CR][LF] |

**Table 99: NMEA Positioning System Mode Indicator**

| Mode | Indicator                       |
|------|---------------------------------|
| A    | Autonomous                      |
| D    | Differential                    |
| E    | Estimated (dead reckoning) mode |
| M    | Manual input                    |
| N    | Data not valid                  |

## 3.56 GPRMC

### *GPS specific information*

**Platform: OEM719, OEM729, OEM7500, OEM7700, OEM7720, PwrPak7, HxGN PIM7500**

This log contains time, date, position, track made good and speed data provided by the GPS navigation receiver. RMC and RMB are the recommended minimum navigation data to be provided by a GNSS receiver.

A comparison of the position precision between this log and other selected NMEA logs can be seen in *Table 98: Position Precision of NMEA Logs* on page 503.

The GPRMC log outputs these messages without waiting for a valid almanac. Instead, it uses a UTC time, calculated with default parameters. In this case, the UTC time status (see the **TIME** log on page 822) is set to WARNING since it may not be one hundred percent accurate. When a valid almanac is available, the receiver uses the real parameters. Then the UTC time status is set to VALID.



If the **NMEATALKER** command (see page 241) is set to AUTO, the talker (the first 2 characters after the \$ sign in the log header) is set to GP (GPS satellites only), GL (GLONASS satellites only) or GN (satellites from both systems) or GA (Galileo satellites only).

**Message ID: 225**

**Log Type: Synch**

**Recommended Input:**

```
log gprmc ontime 1
```

**Example 1 (GPS):**

```
$GPRMC,144326.00,A,5107.0017737,N,11402.3291611,W,0.080,323.3,210307,0.0,E,A*20
```

**Example 2 (Combined GPS and GLONASS):**

```
$GNRMC,143909.00,A,5107.0020216,N,11402.3294835,W,0.036,348.3,210307,0.0,E,A*31
```



See the Note in the **GPGGA** log (see page 497) that applies to all NMEA logs.

| Field | Structure | Field Description  | Symbol | Example |
|-------|-----------|--|--------|---------|
| 1     | \$GPRMC   | Log header. See <i>Messages</i> on page 25 for more information. |        | \$GPRMC |

| Field | Structure  | Field Description   | Symbol    | Example       |
|-------|------------|---|-----------|---------------|
| 2     | utc        | UTC of position   | hhmmss.ss | 144326.00     |
| 3     | pos status | Position status (A = data valid, V = data invalid)  | A         | A             |
| 4     | lat        | Latitude (DDmm.mm)  | llll.ll   | 5107.0017737  |
| 5     | lat dir    | Latitude direction: (N = North, S = South)  | a         | N             |
| 6     | lon        | Longitude (DDDmm.mm)  | yyyyy.yy  | 11402.3291611 |
| 7     | lon dir    | Longitude direction: (E = East, W = West)   | a         | W             |
| 8     | speed Kn   | Speed over ground, knots  | x.x       | 0.080         |
| 9     | track true | Track made good, degrees True   | x.x       | 323.3         |
| 10    | date       | Date: dd/mm/yy  | xxxxxx    | 210307        |
| 11    | mag var    | Magnetic variation, degrees<br>Note that this field is the actual magnetic variation and will always be positive. The direction of the magnetic variation is always positive. | x.x       | 0.0           |
| 12    | var dir    | Magnetic variation direction E/W<br>Easterly variation (E) subtracts from True course.<br>Westerly variation (W) adds to True course.   | a         | E             |
| 13    | mode ind   | Positioning system mode indicator, see <i>Table 99: NMEA Positioning System Mode Indicator</i> on page 516  | a         | A             |
| 14    | *xx        | Check sum   | *hh       | *20           |
| 15    | [CR][LF]   | Sentence terminator   |           | [CR][LF]      |

## 3.57 GPSEPHEM

### *Decoded GPS ephemerides*

**Platform: OEM719, OEM729, OEM7500, OEM7700, OEM7720, PwrPak7, HxGN PIM7500**

This log contains a single set of GPS ephemeris parameters.

**Message ID: 7**

**Log Type: Asynch**

**Recommended Input:**

```
log gpsephema onchanged
```

**ASCII Example:**

```
#GPSEPHEMA, COM1, 12, 59.0, SATTIME, 1337, 397560.000, 02000000, 9145, 1984; 3, 3,
97560.0, 0, 99, 99, 1337, 1337, 403184.0, 2.656004220e+07, 4.971635660e-09, -
2.752651501e+00, 7.1111434372e-03, 6.0071892571e-01, 2.428889275e-
06, 1.024827361e-05, 1.64250000e+02, 4.81562500e+01, 1.117587090e-08, -
7.078051567e-08, 9.2668266314e-01, -1.385772009e-10, -2.098534041e+00, -
8.08319384e-09, 99, 403184.0, -4.190951586e-09, 2.88095e-05, 3.06954e-
12, 0.00000, TRUE, 1.458614684e-04, 4.00000000e+00*0f875b12

#GPSEPHEMA, COM1, 11, 59.0, SATTIME, 1337, 397560.000, 02000000, 9145, 1984; 25,
397560.0, 0, 184, 184, 1337, 1337, 403200.0, 2.656128681e+07, 4.897346851e-
09, 1.905797220e+00, 1.1981436634e-02, -1.440195331e+00, -1.084059477e-
06, 6.748363376e-06, 2.37812500e+02, -1.74687500e+01, 1.825392246e-07, -
1.210719347e-07, 9.5008501632e-01, 2.171519024e-10, 2.086083072e+00, -
8.06140722e-09, 184, 403200.0, -7.450580597e-09, 1.01652e-04, 9.09495e-
13, 0.00000, TRUE, 1.458511425e-04, 4.00000000e+00*18080b24

...

#GPSEPHEMA, COM1, 0, 59.0, SATTIME, 1337, 397560.000, 02000000, 9145, 1984; 1, 39
7560.0, 0, 224, 224, 1337, 1337, 403200.0, 2.656022490e+07, 3.881233098e-
09, 2.938005195e+00, 5.8911956148e-03, -1.716723741e+00, -2.723187208e-
06, 9.417533875e-06, 2.08687500e+02, -5.25625000e+01, 9.126961231e-08, -
7.636845112e-08, 9.8482911735e-01, 1.325055194e-10, 1.162012787e+00, -
7.64138972e-09, 480, 403200.0, -3.259629011e-09, 5.06872e-06, 2.04636e-
12, 0.00000, TRUE, 1.458588731e-04, 4.00000000e+00*97058299
```



The GPSEPHEM log can be used to monitor changes in the orbits of GPS satellites.



To obtain copies of ICD-GPS-200, refer to the GPS website ([www.gps.gov](http://www.gps.gov)).

| Field | Field type     | Description  | Format | Binary Bytes | Binary Offset |
|-------|----------------|--|--------|--------------|---------------|
| 1     | GPSEPHM header | Log header. See <i>Messages</i> on page 25 for more information.   |        | H            | 0             |
| 2     | PRN            | Satellite PRN number   | Ulong  | 4            | H             |
| 3     | tow            | Time stamp of subframe 1 (seconds)   | Double | 8            | H+4           |
| 4     | health         | Health status - a 6-bit health code as defined in ICD-GPS-200  | Ulong  | 4            | H+12          |
| 5     | IODE1          | Issue of ephemeris data 1  | Ulong  | 4            | H+16          |
| 6     | IODE2          | Issue of ephemeris data 2  | Ulong  | 4            | H+20          |
| 7     | week           | toe week number (computed from Z count week)   | Ulong  | 4            | H+24          |
| 8     | z week         | Z count week number. This is the week number from subframe 1 of the ephemeris. The 'toe week' (field #7) is derived from this to account for rollover                                | Ulong  | 4            | H+28          |
| 9     | toe            | Reference time for ephemeris (seconds)   | Double | 8            | H+32          |
| 10    | A              | Semi-major axis (metres)   | Double | 8            | H+40          |
| 11    | $\Delta N$     | Mean motion difference (radians/second)  | Double | 8            | H+48          |
| 12    | $M_0$          | Mean anomaly of reference time (radians)   | Double | 8            | H+56          |
| 13    | ecc            | Eccentricity, dimensionless<br>- quantity defined for a conic section where $e=0$ is a circle, $e=1$ is a parabola, $0 < e < 1$ is an ellipse and $e > 1$ is a hyperbola             | Double | 8            | H+64          |
| 14    | $\omega$       | Argument of perigee (radians)<br>- measurement along the orbital path from the ascending node to the point where the SV is closest to the Earth, in the direction of the SV's motion | Double | 8            | H+72          |
| 15    | cuc            | Argument of latitude (amplitude of cosine, radians)  | Double | 8            | H+80          |
| 16    | cus            | Argument of latitude (amplitude of sine, radians)  | Double | 8            | H+88          |
| 17    | crc            | Orbit radius (amplitude of cosine, metres)   | Double | 8            | H+96          |
| 18    | crs            | Orbit radius (amplitude of sine, metres)   | Double | 8            | H+104         |



| Field | Field type     | Description  | Format | Binary Bytes | Binary Offset |
|-------|----------------|--|--------|--------------|---------------|
| 19    | cic            | Inclination (amplitude of cosine, radians)   | Double | 8            | H+112         |
| 20    | cis            | Inclination (amplitude of sine, radians)   | Double | 8            | H+120         |
| 21    | $I_0$          | Inclination angle at reference time, radians   | Double | 8            | H+128         |
| 22    | $I^0$          | Rate of inclination angle, radians/second  | Double | 8            | H+136         |
| 23    | $\omega_0$     | Right ascension, radians   | Double | 8            | H+144         |
| 24    | $\dot{\omega}$ | Rate of right ascension, radians/second  | Double | 8            | H+152         |
| 25    | iodc           | Issue of data clock  | Ulong  | 4            | H+160         |
| 26    | toc            | SV clock correction term, seconds  | Double | 8            | H+164         |
| 27    | tgdc           | Estimated group delay difference, seconds  | Double | 8            | H+172         |
| 28    | $a_{f0}$       | Clock aging parameter (seconds)  | Double | 8            | H+180         |
| 29    | $a_{f1}$       | Clock aging parameter, (seconds/second)  | Double | 8            | H+188         |
| 30    | $a_{f2}$       | Clock aging parameter, (seconds/second/second)   | Double | 8            | H+196         |
| 31    | AS             | Anti-spoofing on:<br>0 = FALSE<br>1 = TRUE   | Bool   | 4            | H+204         |
| 32    | N              | Corrected mean motion (radians/second)<br><br> This field is computed by the receiver.  | Double | 8            | H+208         |
| 33    | URA            | User Range Accuracy variance (metres <sup>2</sup> )<br><br>The ICD specifies that the URA index transmitted in the ephemerides can be converted to a nominal standard deviation value using an algorithm listed there. We publish the square of the nominal value (variance). The correspondence between the original URA index and the value output is shown in <i>Table 100: URA Variance</i> on the next page | Double | 8            | H+216         |
| 34    | xxxx           | 32-bit CRC (ASCII and Binary only)   | Ulong  | 4            | H+224         |
| 35    | [CR][LF]       | Sentence terminator (ASCII only)   | -      | -            | -             |

**Table 100: URA Variance**

| <b>Index Value (m)</b> | <b>A: Standard Deviations (m)</b> | <b>Variance: A<sup>2</sup> (m<sup>2</sup>)</b> |
|------------------------|-----------------------------------|--|
| 0                      | 2.0                               | 4  |
| 1                      | 2.8                               | 7.84   |
| 2                      | 4.0                               | 16   |
| 3                      | 5.7                               | 32.49  |
| 4                      | 8                                 | 64   |
| 5                      | 11.3                              | 127.69   |
| 6                      | 16.0                              | 256  |
| 7                      | 32.0                              | 1024   |
| 8                      | 64.0                              | 4096   |
| 9                      | 128.0                             | 16384  |
| 10                     | 256.0                             | 65536  |
| 11                     | 512.0                             | 262144   |
| 12                     | 1024.0                            | 1048576  |
| 13                     | 2048.0                            | 4194304  |
| 14                     | 4096.0                            | 16777216                                       |
| 15                     | 8192.0                            | 67108864                                       |

## 3.58 GPVTG

### *Track made good and ground speed*

**Platform: OEM719, OEM729, OEM7500, OEM7700, OEM7720, PwrPak7, HxGN PIM7500**

This log contains the track made good and speed relative to the ground.

The GPVTG log outputs these messages without waiting for a valid almanac. Instead, it uses a UTC time, calculated with default parameters. In this case, the UTC time status (see the **TIME** log on page 822) is set to WARNING since it may not be one hundred percent accurate. When a valid almanac is available, the receiver uses the real parameters. Then the UTC time status is set to VALID.

**Message ID: 226**

**Log Type: Synch**

**Recommended Input:**

```
log gpvtg ontime 1
```

**Example 1 (GPS only):**

```
$GPVTG,172.516,T,155.295,M,0.049,N,0.090,K,D*2B
```

**Example 2 (Combined GPS and GLONASS):**

```
$GNVTG,134.395,T,134.395,M,0.019,N,0.035,K,A*33
```



If the **NMEATALKER** command (see page 241) is set to AUTO, the talker (the first 2 characters after the \$ sign in the log header) is set to GP (GPS satellites only), GL (GLONASS satellites only) or GN (satellites from both systems).



See the Note in the **GPGGA** log (see page 497) that applies to all NMEA logs.

| Field | Structure  | Description   | Symbol | Example |
|-------|------------|---|--------|---------|
| 1     | \$GPVTG    | Log header. See <i>Messages</i> on page 25 for more information.  |        | \$GPVTG |
| 2     | track true | Track made good, degrees True   | x.x    | 24.168  |
| 3     | T          | True track indicator  | T      | T       |
| 4     | track mag  | Track made good, degrees Magnetic;<br>Track mag = Track true + (MAGVAR correction)<br>See the <b>MAGVAR</b> command on page 225 | x.x    | 24.168  |

---

| Field | Structure | Description  | Symbol | Example   |
|-------|-----------|--|--------|-----------|
| 5     | M         | Magnetic track indicator   | M      | M         |
| 6     | speed Kn  | Speed over ground, knots   | x.x    | 0.4220347 |
| 7     | N         | Nautical speed indicator (N = Knots)   | N      | N         |
| 8     | speed Km  | Speed, kilometres/hour   | x.x    | 0.781608  |
| 9     | K         | Speed indicator (K = km/hr)  | K      | K         |
| 10    | mode ind  | Positioning system mode indicator, see <i>Table 99: NMEA Positioning System Mode Indicator</i> on page 516 | a      | A         |
| 11    | *xx       | Check sum  | *hh    | *7A       |
| 12    | [CR][LF]  | Sentence terminator  |        | [CR][LF]  |

## 3.59 GPZDA

### *UTC time and date*

**Platform: OEM719, OEM729, OEM7500, OEM7700, OEM7720, PwrPak7, HxGN PIM7500**

The GPZDA log outputs the UTC date and time. If no valid almanac is stored in the receiver, a default UTC offset is used to generate the time until a new almanac is downloaded. If the offset is not up-to-date, this initial UTC time may be incorrect until the new almanac is present.

**Message ID: 227**

**Log Type: Synch**

**Recommended Input:**

```
log gpzda ontime 1
```

**Example:**

```
$GPZDA,143042.00,25,08,2005,,*6E
```



See the Note in the **GPGGA** log (see page 497) that applies to all NMEA logs.

| Field | Structure | Description   | Symbol    | Example                         |
|-------|-----------|---|-----------|---------------------------------|
| 1     | \$GPZDA   | Log header. See <i>Messages</i> on page 25 for more information.  |           | \$GPZDA                         |
| 2     | utc       | UTC time status   | hhmmss.ss | 220238.00                       |
| 3     | day       | Day, 01 to 31   | xx        | 15                              |
| 4     | month     | Month, 01 to 12   | xx        | 07                              |
| 5     | year      | Year  | xxxx      | 1992                            |
| 6     | null      | Local zone description—not available<br><br><div style="border: 1px solid black; padding: 5px; width: fit-content;">  Local time zones are not supported by OEM7 family receivers. Fields 6 and 7 are always null. </div> | xx        | (empty when no data is present) |
| 7     | null      | Local zone minutes description—not available  | xx        | (empty when no data is present) |
| 8     | *xx       | Check sum   | *hh       | *6F                             |
| 9     | [CR][LF]  | Sentence terminator   |           | [CR][LF]                        |

## 3.60 HEADING2

### *Heading information with multiple rovers*

**Platform: OEM719, OEM729, OEM7500, OEM7700, OEM7720, PwrPak7, HxGN PIM7500**

The heading is the angle from True North of the base to rover vector in a clockwise direction. This log can be output at both Master and Rover ends.



An ALIGN capable receiver is required to use this log.



Asynchronous logs, such as HEADING2, should only be logged ONCHANGED or ONNEW otherwise the most current data is not available or included in the output. An example of this occurrence is in the ONTIME trigger. If this trigger is not logged ONNEW or ONCHANGED, it may cause inaccurate time tags.

The HEADING2 log is dictated by the output frequency of the master receiver sending out RTCAOBS2, RTCAOBS3 or NovAtelXObs messages. HEADING2 supports 20 Hz output rate. Ensure sufficient radio bandwidth is available between the ALIGN Master and the ALIGN Rover.

**Message ID: 1335**

**Log Type: Asynch**

**Recommended Input:**

```
log heading2a onnew
```

**ASCII Example:**

```
#HEADING2A,COM1,0,39.5,FINESTEERING,1622,422892.200,02040000,f9bf,6521
;SOL_COMPUTED,NARROW_INT,0.927607417,178.347869873,-
1.3037414550.0,0.261901051,0.391376048,"R222","AAAA",18,17,17,16,0,01,
0,33*7be836f6
```

| Field | Field type      | Description   | Binary Format | Binary Bytes | Binary Offset |
|-------|-----------------|---|---------------|--------------|---------------|
| 1     | HEADING2 header | Log header. See <i>Messages</i> on page 25 for more information.          |               | H            | 0             |
| 2     | sol stat        | Solution status, see <i>Table 73: Solution Status</i> on page 419         | Enum          | 4            | H             |
| 3     | pos type        | Position type, see <i>Table 74: Position or Velocity Type</i> on page 420 | Enum          | 4            | H+4           |

| Field | Field type                  | Description  | Binary Format | Binary Bytes | Binary Offset |
|-------|-----------------------------|--|---------------|--------------|---------------|
| 4     | length                      | Baseline length in metres<br>For Z ALIGN Rovers, this field outputs decimal portion of the baseline              | Float         | 4            | H+8           |
| 5     | heading                     | Heading in degrees (0° to 359.999°)  | Float         | 4            | H+12          |
| 6     | pitch                       | Pitch (±90 degrees)  | Float         | 4            | H+16          |
| 7     | Reserved                    |  | Float         | 4            | H+20          |
| 8     | hdg std dev                 | Heading standard deviation in degrees  | Float         | 4            | H+24          |
| 9     | ptch std dev                | Pitch standard deviation in degrees  | Float         | 4            | H+28          |
| 10    | rover stn ID                | Rover Receiver ID<br>Set using the <b>SETROVERID</b> command (see page 343) on the Rover<br>e.g. setroverid RRRR | Char[4]       | 4            | H+32          |
| 11    | Master stn ID               | Master Receiver ID<br>Set using the <b>DGPSTXID</b> command (see page 121) on the Master<br>Default: AAAA        | Char[4]       | 4            | H+36          |
| 12    | #SVs                        | Number of satellites tracked   | Uchar         | 1            | H+40          |
| 13    | #solnSVs                    | Number of satellites in solution   | Uchar         | 1            | H+41          |
| 14    | #obs                        | Number of satellites above the elevation mask angle  | Uchar         | 1            | H+42          |
| 15    | #multi                      | Number of satellites above the mask angle with L2  | Uchar         | 1            | H+43          |
| 16    | sol source                  | Solution source (see <i>Table 101: Solution Source</i> on the next page)   | Hex           | 1            | H+44          |
| 17    | ext sol stat                | Extended solution status (see <i>Table 77: Extended Solution Status</i> on page 423)                             | Uchar         | 1            | H+45          |
| 18    | Galileo and BeiDou sig mask | Galileo and BeiDou signals used mask (see <i>Table 76: Galileo and BeiDou Signal-Used Mask</i> on page 423)      | Hex           | 1            | H+46          |
| 19    | GPS and GLONASS sig mask    | GPS and GLONASS signals used mask (see <i>Table 75: GPS and GLONASS Signal-Used Mask</i> on page 422)            | Hex           | 1            | H+47          |
| 20    | xxxx                        | 32-bit CRC (ASCII and Binary only)   | Hex           | 4            | H+48          |

---

| Field | Field type | Description                      | Binary Format | Binary Bytes | Binary Offset |
|-------|------------|----------------------------------|---------------|--------------|---------------|
| 21    | [CR][LF]   | Sentence terminator (ASCII only) | -             | -            | -             |

**Table 101: Solution Source**

| Bit | Mask | Description  |
|-----|------|--|
| 0-1 | 0x03 | Reserved   |
| 2-3 | 0x0C | Source antenna<br>0 = Primary antenna<br>1 = Secondary antenna |
| 4-7 | 0xF0 | Reserved   |



## 3.61 HEADINGRATE

### *Heading rate information*

**Platform: OEM719, OEM729, OEM7500, OEM7700, OEM7720, PwrPak7, HxGN PIM7500**

This log provides rate of change for the heading parameters. The heading is the angle from True North of the base to rover vector in a clockwise direction.



You must have an ALIGN capable receiver to use this log.

**Message ID: 1698**

**Log Type: Asynch**

**Recommended Input:**

log headingratea onchanged

**ASCII Example:**

```
#HEADINGRATEA, UNKNOWN, 0, 60.0, FINESTEERING, 1873, 411044.700, 02040008, c53
a, 32768; SOL_COMPUTED, NARROW_INT, 0.025000000, 0.000000000, -
0.308837891, 0.575313330, 0.000000000, 1.264251590, 1.663657904, 0.0, "748M"
, "725U", 00, 0, 0, 0*66f97b96
```

| Field | Field type         | Description  | Format | Binary Bytes | Binary Offset |
|-------|--------------------|--|--------|--------------|---------------|
| 1     | HEADINGRATE header | Log header. See <i>Messages</i> on page 25 for more information.   |        | H            | 0             |
| 2     | sol stat           | Solution status, see <i>Table 73: Solution Status</i> on page 419  | Enum   | 4            | H             |
| 3     | pos type           | Position type, see <i>Table 74: Position or Velocity Type</i> on page 420  | Enum   | 4            | H+4           |
| 4     | latency            | A measure of the latency in the velocity time tag in seconds. It should be subtracted from the time to give improved results.  | Float  | 4            | H+8           |
| 5     | length rate        | Rate of change of the baseline length in m/s. For Z ALIGN rovers, this field outputs the decimal portion of the baseline rate. | Float  | 4            | H+12          |
| 6     | heading rate       | Rate of change of the heading in degrees/s   | Float  | 4            | H+16          |
| 7     | pitch rate         | Rate of change of the pitch in degrees/s   | Float  | 4            | H+20          |

| Field | Field type           | Description  | Format | Binary Bytes | Binary Offset |
|-------|----------------------|--|--------|--------------|---------------|
| 8     | length rate std dev  | Baseline rate standard deviation in m/s  | Float  | 4            | H+24          |
| 9     | heading rate std dev | Heading rate standard deviation in degrees/s   | Float  | 4            | H+28          |
| 10    | pitch rate std dev   | Pitch rate standard deviation in degrees/s   | Float  | 4            | H+32          |
| 11    | Reserved             |  | Float  | 4            | H+36          |
| 12    | rover stn ID         | Rover Receiver ID<br>Set using the <b>SETROVERID</b> command (see page 343) on the Rover receiver. For example, setroverid RRRR. | Uchar  | 4            | H+40          |
| 13    | master stn ID        | Master Receiver ID<br>Set using the <b>DGPSTXID</b> command (see page 121) on the Master receiver. Default: AAAA                 | Uchar  | 4            | H+44          |
| 14    | sol source           | Solution source (see <i>Table 101: Solution Source</i> on page 528)  | Hex    | 1            | H+48          |
| 15    | Reserved             |  | Uchar  | 1            | H+49          |
| 16    | Reserved             |  | Uchar  | 1            | H+50          |
| 17    | Reserved             |  | Uchar  | 1            | H+51          |
| 18    | xxxx                 | 32-bit CRC (ASCII and Binary only)   | Hex    | 4            | H+52          |
| 19    | [CR][LF]             | Sentence terminator (ASCII only)   | -      | -            | -             |

## 3.62 HEADINGSATS

### *Satellite used in heading solution*

**Platform: OEM719, OEM729, OEM7500, OEM7700, OEM7720, PwrPak7, HxGN PIM7500**

This log provides information on the satellites that are used in a heading solution.



The HEADINGSATS log can only be used from the ALIGN rover.

**Message ID: 1316**

**Log Type: Asynch**

**Recommended Input:**

```
log headingsatsa onnew
```

**ASCII Example:**

```
#HEADINGSATSA,COM1,0,26.0,FINESTEERING,1625,344654.600,02000008,f5b0,6
569;17,GPS,31,GOOD,00000003,GPS,23,GOOD,00000003,GPS,30,GOOD,00000003,
GPS,16,GOOD,00000003,GPS,20,GOOD,00000003,GPS,25,GOOD,00000003,GPS,4,G
OOD,00000003,GPS,24,GOOD,00000003,GPS,11,GOOD,00000003,GPS,32,GOOD,000
00003,GPS,14,GOOD,00000003,GLONASS,20+2,GOOD,00000003,GLONASS,14-
7,GOOD,00000001,GLONASS,2-4,GOOD,00000003,GLONASS,13-
2,GOOD,00000003,GLONASS,12-
1,GOOD,00000003,GLONASS,19+3,GOOD,00000001*15ec53a6
```

| Field | Field type  | Description  | Format | Binary Bytes | Binary Offset |
|-------|-------------|--|--------|--------------|---------------|
| 1     | HEADINGSATS | Log header. See <i>Messages</i> on page 25 for more information. |        | H            | 0             |
| 2     | #entries    | Number of records to follow                                      | Ulong  | 4            | H             |
| 3     | System      | Refer to <i>Table 102: Satellite System</i> on the next page.    | Enum   | 4            | H+4           |

| Field | Field type                                  | Description  | Format | Binary Bytes | Binary Offset  |
|-------|---|--|--------|--------------|----------------|
| 4     | Satellite ID                                | In binary logs, the satellite ID field is 4 bytes. The 2 lowest-order bytes, interpreted as a USHORT, are the system identifier: for instance, the PRN for GPS, or the slot for GLONASS. The 2 highest-order bytes are the frequency channel for GLONASS, interpreted as a SHORT and zero for all other systems.<br><br>In ASCII and abbreviated ASCII logs, the satellite ID field is the system identifier. If the system is GLONASS and the frequency channel is not zero, then the signed channel is appended to the system identifier. For example, slot 13, frequency channel -2 is output as 13-2 | Ulong  | 4            | H+8            |
| 5     | Status                                      | see <i>Table 79: Observation Statuses</i> on page 426  | Enum   | 4            | H+12           |
| 6     | Signal Mask                                 | see<br><i>Table 80: BESTSATS GPS Signal Mask</i> on page 427,<br><i>Table 81: BESTSATS GLONASS Signal Mask</i> on page 428,<br><i>Table 82: BESTSATS Galileo Signal Mask</i> on page 428,<br><i>Table 83: BESTSATS BeiDou Signal Mask</i> on page 428  | Hex    | 4            | H+16           |
| 7     | Next satellite offset = H + 4 + (#sat x 16) |  |        |              |                |
| 8     | xxxx  | 32-bit CRC (ASCII and Binary only)   | Hex    | 4            | H+4+ (#satx16) |
| 9     | [CR][LF]                                    | Sentence Terminator (ASCII only)   | -      | -            | -              |

**Table 102: Satellite System**

| Binary Value | ASCII Mode Name |
|--------------|-----------------|
| 0            | GPS             |
| 1            | GLONASS         |
| 2            | SBAS            |

| <b>Binary Value</b> | <b>ASCII Mode Name</b> |
|---------------------|------------------------|
| 5                   | Galileo                |
| 6                   | BeiDou                 |
| 7                   | QZSS                   |
| 9                   | NAVIC                  |

## 3.63 HWMONITOR

### *Monitor hardware levels*

**Platform: OEM719, OEM729, OEM7500, OEM7700, OEM7720, PwrPak7, HxGN PIM7500**

This log allows the user to monitor temperature, antenna current and voltages.

**Message ID: 963**

**Log Type: Polled**

**Recommended Input:**

```
log hwmonitora ontime 10
```

**ASCII Example:**

```
#HWMONITORA,COM1,0,90.5,FINESTEERING,1928,153778.000,02000020,52db,327
68;7,43.284492493,100,0.000000000,200,5.094994068,700,1.195970654,800,
3.279609442,f00,1.811965823,1100,44.017093658,1600*52beac4b
```

| Field | Field Type   | Description   | Format   | Binary Bytes | Binary Offset             |
|-------|--|---|----------|--------------|---------------------------|
| 1     | HWMONITOR header                                   | Log header. See <i>Messages</i> on page 25 for more information.  |          | H            | 0                         |
| 2     | # measurements                                     | Number of measurements to follow  | Ulong    | 4            | H                         |
| 3     | reading  | Temperature, antenna current or voltage reading<br>Units: <ul style="list-style-type: none"> <li>• Degree Celsius for Temperature</li> <li>• Amps for Antenna Current</li> <li>• Volts for Voltage</li> </ul> | Float    | 4            | H+4                       |
| 4     | status   | See <i>Table 103: HWMONITOR Status Table</i> on the next page   | HexUlong | 4            | H+8                       |
| 5...  | Next reading offset = H + 4 + (# measurements x 8) |   |          |              |                           |
| 6     | xxxx   | 32-bit CRC (ASCII and Binary only)  | Hex      | 4            | H+4+ (# measurements x 8) |
| 7     | [CR][LF]   | Sentence Terminator (ASCII only)  | -        | -            | -                         |

**Table 103: HWMONITOR Status Table**

| <b>Bits</b> | <b>Description</b>  | <b>Applicable Platforms</b> |
|-------------|---|-----------------------------|
| 0-7         | Boundary Limit Status (Hex):<br>0x00 = Value falls within acceptable bounds<br>0x01 = Value is under the lower warning limit<br>0x02 = Value is under the lower error limit<br>0x03 = Value is over the upper warning limit<br>0x04 = Value is over the upper error limit |                             |

| Bits | Description   | Applicable Platforms                      |
|------|---|---|
| 8-15 | Reading Type (Hex):   |   |
|      | 0x00 = Reserved   |   |
|      | 0x01 = Temperature<br>A temperature sensor is located on the receiver and provides the approximate temperature of the PCB surface near critical components (for example, CPU, TCXO) (degrees Celsius) | All                                       |
|      | 0x02 = Antenna Current<br>The amount of current being drawn by the active antenna (mA)  | OEM719, OEM729, OEM7700, OEM7720, PwrPak7 |
|      | 0x07 = Antenna Voltage  | OEM719, OEM729, OEM7700, OEM7720, PwrPak7 |
|      | 0x08 = Digital Core Voltage<br>Internal regulator output voltage supplying a key component on the receiver (Volts)  | All                                       |
|      | 0x0F = Supply Voltage<br>Internal regulator output voltage supplying a key component on the receiver (Volts)  | All                                       |
|      | 0x11 = 1V8  | All                                       |
|      | 0x16 = Secondary Temperature<br>A second temperature sensor is located on the receiver PCB (degrees Celsius)  | OEM719, OEM729, OEM7700, OEM7720, PwrPak7 |
|      | 0x17 = Peripheral Core Voltage  | OEM719, OEM729, OEM7700, OEM7720, PwrPak7 |
|      | 0x18 = Secondary Antenna Current  | OEM7720                                   |
|      | 0x19 = Secondary Antenna Voltage  | OEM7720                                   |



## 3.64 IONUTC

### *Ionospheric and UTC data*

**Platform: OEM719, OEM729, OEM7500, OEM7700, OEM7720, PwrPak7, HxGN PIM7500**

This log contains the Ionospheric Model parameters (ION) and the Universal Time Coordinated parameters (UTC).

**Message ID: 8**

**Log Type: Asynch**

**Recommended Input:**

```
log ionutca onchanged
```

**ASCII Example:**

```
#IONUTCA,COM1,0,58.5,FINESTEERING,1337,397740.107,02000000,ec21,1984;1
.210719347000122e-08,2.235174179077148e-08,-5.960464477539062e-08,-
1.192092895507812e-07,1.003520000000000e+05,1.146880000000000e+05,-
6.553600000000000e+04,-3.276800000000000e+05,1337,589824,-
1.2107193470001221e-08,-3.907985047e-14,1355,7,13,14,0*c1dfd456
```



The Receiver-Independent Exchange (RINEX<sup>1a</sup>) format is a broadly accepted, receiver independent format for storing GPS data. It features a non-proprietary ASCII file format that can be used to combine or process data generated by receivers made by different manufacturers.

Use the NovAtel's Convert utility to produce RINEX files from NovAtel receiver data files. For the best results, the NovAtel receiver input data file should contain the logs as specified in the *NovAtel Firmware and Software* chapter of the [OEM7 Installation and Operation User Manual](#) including IONUTC.

| Field | Field type    | Description  | Format | Binary Bytes | Binary Offset |
|-------|---------------|--|--------|--------------|---------------|
| 1     | IONUTC header | Log header. See <i>Messages</i> on page 25 for more information. |        | H            | 0             |
| 2     | a0            | Alpha parameter constant term                                    | Double | 8            | H             |
| 3     | a1            | Alpha parameter 1st order term                                   | Double | 8            | H+8           |
| 4     | a2            | Alpha parameter 2nd order term                                   | Double | 8            | H+16          |
| 5     | a3            | Alpha parameter 3rd order term                                   | Double | 8            | H+24          |

<sup>a</sup>Refer to the U.S. National Geodetic Survey website at: [www.ngs.noaa.gov/CORS/data.shtml](http://www.ngs.noaa.gov/CORS/data.shtml).

| Field | Field type | Description  | Format | Binary Bytes | Binary Offset |
|-------|------------|--|--------|--------------|---------------|
| 6     | b0         | Beta parameter constant term                                       | Double | 8            | H+32          |
| 7     | b1         | Beta parameter 1st order term                                      | Double | 8            | H+40          |
| 8     | b2         | Beta parameter 2nd order term                                      | Double | 8            | H+48          |
| 9     | b3         | Beta parameter 3rd order term                                      | Double | 8            | H+56          |
| 10    | utc wn     | UTC reference week number  | Ulong  | 4            | H+64          |
| 11    | tot        | Reference time of UTC parameters                                   | Ulong  | 4            | H+68          |
| 12    | A0         | UTC constant term of polynomial                                    | Double | 8            | H+72          |
| 13    | A1         | UTC 1st order term of polynomial                                   | Double | 8            | H+80          |
| 14    | wn Isf     | Future week number   | Ulong  | 4            | H+88          |
| 15    | dn         | Day number (the range is 1 to 7 where Sunday = 1 and Saturday = 7) | Ulong  | 4            | H+92          |
| 16    | deltat Is  | Delta time due to leap seconds                                     | Long   | 4            | H+96          |
| 17    | deltat Isf | Future delta time due to leap seconds                              | Long   | 4            | H+100         |
| 18    | Reserved   |  |        | 4            | H+104         |
| 19    | xxxx       | 32-bit CRC (ASCII and Binary only)                                 | Hex    | 4            | H+108         |
| 20    | [CR][LF]   | Sentence terminator (ASCII only)                                   | -      | -            | -             |

## 3.65 IPSTATS

### *IP statistics*

**Platform:** OEM729, OEM7700, OEM7720, PwrPak7

This log contains the current IP interface statistics.

**Message ID:** 1669

**Log Type:** Polled

**Recommended Input:**

```
log ipstatsa
```

**ASCII Example:**

```
#IPSTATSA,COM1,0,70.5,FINESTEERING,1749,328376.337,02000020,0d94,45068
;1,CELL,0,526,526*01c4847c
```

| Field | Field Type                                  | Description  | Format | Binary Bytes | Binary Offset             |
|-------|---|--|--------|--------------|---------------------------|
| 1     | IPSTATS header                              | Log header. See <i>Messages</i> on page 25 for more information. |        | H            | 0                         |
| 2     | #Interface                                  | Number of records to follow.                                     | Ulong  | 4            | H                         |
| 3     | Physical Interface                          | IP Interface Type<br>1 = ALL<br>2 = ETHA                         | Enum   | 4            | H+4                       |
| 4     | Reserved                                    |  | Ulong  | 4            | H+8                       |
| 5     | Receive Bytes                               | Total number of bytes received                                   | Ulong  | 4            | H+12                      |
| 6     | Transmit Bytes                              | Total number of bytes transmitted                                | Ulong  | 4            | H+16                      |
| 7     | Next reading offset = H+4+(#Interface * 16) |  |        |              |                           |
| 8     | xxxx  | 32-bit CRC (ASCII and Binary only)                               | Hex    | 4            | H+4+<br>(#Interface * 16) |
| 9     | [CR][LF]                                    | Sentence terminator (ASCII only)                                 | -      | -            | -                         |

## 3.66 IPSTATUS

### *Current network configuration status*

**Platform:** OEM729, OEM7700, OEM7720, PwrPak7

This log provides the configuration of IP address, netmask, gateway and a list of DNS servers currently in use.

**Message ID:** 1289

**Log Type:** Polled

**Recommended Input:**

```
log ipstatusa once
```

**ASCII Example:**

```
#IPSTATUSA,COM1,0,90.5,FINESTEERING,1609,500464.121,02000000,7fe2,6259
;1,ETHA,"10.4.44.131","255.255.255.0","10.4.44.1",1,"198.161.72.85"*ec
22236c
```

| Field | Field Type                              | Description   | Format         | Binary Bytes  | Binary Offset |
|-------|---|---|----------------|---------------|---------------|
| 1     | IPSTATUS Header                         | Log header. See <i>Messages</i> on page 25 for more information.                                      | -              | H             | 0             |
| 2     | #IPrec                                  | Number of records to follow   | Ulong          | 4             | H             |
| 3     | interface                               | Name of the network interface<br>2 = ETHA   | Enum           | 4             | H+4           |
| 4     | IP address                              | IP Address-decimal dot notation   | String<br>[16] | variable<br>1 | H+8           |
| 5     | netmask                                 | Netmask-decimal dot notation  | String<br>[16] | variable<br>1 | H+24          |
| 6     | gateway                                 | Gateway-decimal dot notation<br>This is the default gateway that is currently in use by the receiver. | String<br>[16] | variable<br>1 | H+40          |
| 7...  | Next reading offset = H+4+(#IPrec * 52) |   |                |               |               |

<sup>1</sup>In the binary case, each string field needs to be NULL terminated and additional bytes of padding added to maintain 4-byte alignment, up to the maximum defined by the string size. The next defined field starts immediately at the next 4-byte alignment following the NULL.

| Field | Field Type   | Description                        | Format      | Binary Bytes  | Binary Offset                                |
|-------|--|------------------------------------|-------------|---------------|--|
| 8     | #dnserver  | Number of DNS Servers to follow    | Ulong       | 4             | H+4+<br>(#IPrec x 52)                        |
| 9     | server IP address  | IP address-decimal dot notation    | String [16] | variable<br>1 | H+4+<br>(#IPrec x 52)+4                      |
| 10... | Next reading offset = H+4+(#IPrec * 52)+4+(#dnserver * 16) |                                    |             |               |  |
| 11    | xxxx   | 32-bit CRC (ASCII and Binary only) | Hex         | 4             | H+4+<br>(#IPrec x 52)+4+<br>(#dnserver x 16) |
| 12    | [CR][LF]   | Sentence terminator (ASCII only)   | -           | -             | -  |

## 3.67 ITBANDPASSBANK

### *Allowable band pass filter configurations*

**Platform: OEM719, OEM729, OEM7500, OEM7700, OEM7720, PwrPak7, HxGN PIM7500**

The ITBANDPASSBANK log provides information on the allowable configurations for each frequency when applying a bandpass filter.

**Message ID: 2022**

**Log Type: Asynch**

**Recommended Input:**

```
log itbandpassbanka once
```

**Abbreviated ASCII Example:**

```
<ITBANDPASSBANK USB1 0 87.5 FINESTEERING 1933 346809.694 12000020 fb2e
14137
5
GPSL5 1164.3750 1173.1250 1178.1250 1186.8750 0.05
GALILEOE5B 1195.6250 1204.3750 1209.3750 1218.1250 0.05
BEIDOUB1 1551.2500 1560.0000 1565.0000 1573.7500 0.05
BEIDOUB2 1195.6250 1204.3750 1209.3750 1218.1250 0.05
QZSSL5 1164.3750 1173.1250 1178.1250 1186.8750 0.05
```

| Field | Field Type                 | Description  | Format | Binary Bytes | Binary Offset |
|-------|----------------------------|--|--------|--------------|---------------|
| 1     | ITBANDPASSBANK header      | Log header. See <i>Messages</i> on page 25 for more information. | -      | H            | 0             |
| 2     | # of entries               | Number of entries to follow                                      | Ulong  | 4            | H             |
| 3     | frequency                  | See <i>Table 48: Frequency Types</i> on page 210                 | Enum   | 4            | H+4           |
| 4     | min lower frequency cutoff | The minimum frequency cutoff at the lower end (MHz)              | Float  | 4            | H+8           |
| 5     | max lower frequency cutoff | The maximum frequency cutoff at the lower end (MHz)              | Float  | 4            | H+12          |
| 6     | min upper frequency cutoff | The minimum frequency cutoff at the upper end (MHz)              | Float  | 4            | H+16          |
| 7     | max upper frequency cutoff | The maximum frequency cutoff at the upper end (MHz)              | Float  | 4            | H+20          |

| Field | Field Type  | Description                                    | Format | Binary Bytes | Binary Offset              |
|-------|---|--|--------|--------------|----------------------------|
| 8     | frequency step                                      | The minimum cut off frequency resolution (MHz) | Float  | 4            | H+24                       |
| 9     | Next entry offset = $H + 4 + (\#entries \times 24)$ |  |        |              |                            |
| 10    | xxxx  | 32-bit CRC (ASCII and Binary only)             | Ulong  | 4            | H+4+<br>(#entries<br>x 24) |
| 11    | [CR][LF]  | Sentence terminator (ASCII only)               | -      | -            | -                          |

## 3.68 ITDETECTSTATUS

### *Interference detection status*

**Platform: OEM719, OEM729, OEM7500, OEM7700, OEM7720, PwrPak7, HxGN PIM7500**

This log lists all of the detected interferences from all active paths where interference detection is enabled.



This log should be used with the **onchanged** trigger only.

**Message ID: 2065**

**Log Type: Asynch**

**Recommended Input:**

```
log itdetectstatus onchanged
```

#### ASCII Example

```
#ITDETECTSTATUSA,USB2,0,74.0,FINESTEERING,1982,430605.267,0200c000,7fd
b,32768;3,L1,STATISTICANALYSIS,-
0.718,29.167,0.126,12.797,00000000,00000000,00000000,L2,SPECTRUMANALYS
IS,1249.961,71.191,-56.769,-
132.907,00000000,00000000,00000000,L2,SPECTRUMANALYSIS,1289.512,1.978,-
75.967,-138.493,00000000,00000000,00000000*5e83b175
```

| Field | Field Type                  | Description  | Format | Binary Bytes | Binary Offset |
|-------|-----------------------------|--|--------|--------------|---------------|
| 1     | ITDETECTSTATUS header       | Log header. See <i>Messages</i> on page 25 for more information.                               | -      | H            | 0             |
| 2     | # of entries                | Number of interferences to follow  | Ulong  | 4            | H             |
| 3     | RF Path                     | RF path for this entry.<br>2 = L1<br>3 = L2<br>5 = L5  | Enum   | 4            | H+4           |
| 4     | Interference detection type | Interference detection type for this entry.<br>0 = SPECTRALANALYSIS<br>1 = STATISTICALANALYSIS | Enum   | 4            | H+8           |



| Field | Field Type  | Description  | Format | Binary Bytes | Binary Offset             |
|-------|---|--|--------|--------------|---------------------------|
| 5     | Parameter 1   | The first parameter of the interference.<br>For SPECTRALANALYSIS type, this is the center frequency in MHz.<br>For STATISTICALANALYSIS type, this is reserved.   | Float  | 4            | H+12                      |
| 6     | Parameter 2   | The second parameter of the interference.<br>For SPECTRALANALYSIS type, this is the bandwidth in MHz.<br>For STATISTICALANALYSIS type, this is reserved.   | Float  | 4            | H+16                      |
| 7     | Parameter 3   | The third parameter of the interference.<br>For SPECTRALANALYSIS type, this is the estimated power in dBm of the interference.<br>For STATISTICALANALYSIS type, this is reserved.                            | Float  | 4            | H+20                      |
| 8     | Parameter 4   | The fourth parameter of the interference.<br>For SPECTRALANALYSIS type, this is the highest estimated power spectrum density in dBmHz of the interference.<br>For STATISTICALANALYSIS type this is reserved. | Float  | 4            | H+24                      |
| 9     | Reserved 1  | Reserved   | Ulong  | 4            | H+28                      |
| 10    | Reserved 2  | Reserved   | Ulong  | 4            | H+32                      |
| 11    | Reserved 3  | Reserved   | Ulong  | 4            | H+36                      |
| 12    | Next interference signal offset = $H + 4 + (\#entries \times 36)$ |  |        |              |                           |
| 13    | xxxx  | 32-bit CRC (ASCII and Binary only)   | Ulong  | 4            | H=4+<br>(#entries<br>x16) |
| 14    | [CR][LF]  | Sentence terminator (ASCII only)   | -      | -            | -                         |

## 3.69 ITFILTTABLE

### *Filter configuration for each frequency*

**Platform: OEM719, OEM729, OEM7500, OEM7700, OEM7720, PwrPak7, HxGN PIM7500**

The ITFILTTABLE log contains the filter configuration summary for each frequency. It lists which bandpass or notch filters are enabled and how each is configured.

**Message ID: 1991**

**Log Type: Asynch**

**Recommended Input:**

```
log itfiltablea once
```

**ASCII Example:**

```
#ITFILTTABLEA,USB2,0,80.5,FINESTEERING,1923,232588.825,12000000,35d0,3
2768;
13,
GPSL1,8,CIC3,00000001,DISABLE,0.0000,0.0000,1,
ENABLE,PF0,NOTCHFILTER,1572.2500,1577.7500,1.000,
GPSL2,4,CIC3,00000000,DISABLE,0.0000,0.0000,0,
GLONASSL1,9,CIC3,00000000,DISABLE,0.0000,0.0000,0,
GLONASSL2,5,CIC3,00000000,DISABLE,0.0000,0.0000,0,
GPSL5,0,CIC3,00000000,DISABLE,0.0000,0.0000,0,
...
QZSSL1,8,CIC3,00000001,DISABLE,0.0000,0.0000,1,
ENABLE,PF0,NOTCHFILTER,1572.2500,1577.7500,1.000,
QZSSL2,4,CIC3,00000000,DISABLE,0.0000,0.0000,0,
QZSSL5,0,CIC3,00000000,DISABLE,0.0000,0.0000,0*3ca84167
```

| Field | Field Type         | Description  | Format | Binary Bytes | Binary Offset |
|-------|--------------------|--|--------|--------------|---------------|
| 1     | ITFILTTABLE header | Log header. See <i>Messages</i> on page 25 for more information.                               | -      | H            | 0             |
| 2     | # entries          | Number of records with information to follow   | Ulong  | 4            | H             |
| 3     | frequency          | The frequency at which the filter is applied. See <i>Table 48: Frequency Types</i> on page 210 | Enum   | 4            | H+4           |
| 4     | Encoder ID         | ID of the digital path used by this frequency  | Ulong  | 4            | H+8           |
| 5     | DDC filter type    | The DDC filter type (see <i>Table 104: DDC Filter Type</i> on page 548)                        | Enum   | 4            | H+12          |

| Field | Field Type  | Description  | Format | Binary Bytes | Binary Offset |
|-------|---|--|--------|--------------|---------------|
| 6     | status word   | Filter warning limit status. Raise a warning flag if the filter is placed too close to the center frequency of the GNSS signal (see <i>Table 105: ITFILTable Status Word</i> on the next page) | Ulong  | 4            | H+16          |
| 7     | switch  | Filter is enabled or disabled (see <i>Table 106: Filter Switches</i> on page 549)  | Enum   | 4            | H+20          |
| 8     | lower cut off frequency   | Cut off frequency at the lower end (MHz)   | Float  | 4            | H+24          |
| 9     | upper cut off frequency   | Cut off frequency at the upper end (MHz)   | Float  | 4            | H+28          |
| 10    | # prog filters  | Number of programmable filters applied   | Ulong  | 4            | H+32          |
| 11    | switch  | Filter is enabled or disabled (see <i>Table 106: Filter Switches</i> on page 549)  | Enum   | 4            | H+36          |
| 12    | prog filter ID  | The programmable filter ID (see <i>Table 45: Programmable Filter ID</i> on page 207)   | Enum   | 4            | H+40          |
| 13    | mode  | Programmable filter mode (notch filter or bandpass) (see <i>Table 46: Programmable Filter Mode</i> on page 207)  | Enum   | 4            | H+44          |
| 14    | lower cut off frequency   | Cut off frequency at the lower end (MHz)   | Float  | 4            | H+48          |
| 15    | upper cut off frequency   | Cut off frequency at the upper end (MHz)   | Float  | 4            | H+52          |
| 16    | notch width   | Width of notch filter (MHz)  | Float  | 4            | H+56          |
| 15    | Next program filter – H+4+(#entries x 20) + 4 + (#progfilters x 24)                     |  |        |              |               |
| 16    | Next frequency – H+4+(#entries x 20) + 4 + SUM(#progfilters x 24) <sub>0-#entries</sub> |  |        |              |               |
| 17    | xxxx  | 32-bit CRC (ASCII and Binary only)   | Ulong  | 4            | variable      |
| 18    | [CR][LF]  | Sentence terminator (ASCII only)   | -      | -            | -             |

**Table 104: DDC Filter Type**

| Binary | ASCII       |
|--------|-------------|
| 0      | PASSTHROUGH |
| 1      | CIC1        |
| 2      | CIC2        |
| 3      | CIC3        |
| 4      | HALFBAND    |

**Table 105: ITFILTable Status Word**

| Nibble | Bit | Mask       | Description           | Range Value                                |
|--------|-----|------------|-----------------------|--|
| N0     | 0   | 0x00000001 | First enabled filter  | 0 = Within acceptable limit<br>1 = Warning |
|        | 1   | 0x00000002 |                       |  |
|        | 2   | 0x00000004 |                       |  |
|        | 3   | 0x00000008 |                       |  |
| N1     | 4   | 0x00000010 |                       |  |
|        | 5   | 0x00000020 |                       |  |
|        | 6   | 0x00000040 |                       |  |
|        | 7   | 0x00000080 |                       |  |
| N2     | 8   | 0x00000100 | Second enabled filter | 0 = Within acceptable limit<br>1 = Warning |
|        | 9   | 0x00000200 |                       |  |
|        | 10  | 0x00000400 |                       |  |
|        | 11  | 0x00000800 |                       |  |
| N3     | 12  | 0x00001000 |                       |  |
|        | 13  | 0x00002000 |                       |  |
|        | 14  | 0x00004000 |                       |  |
|        | 15  | 0x00008000 |                       |  |

| Nibble | Bit | Mask       | Description           | Range Value                                |
|--------|-----|------------|-----------------------|--|
| N4     | 16  | 0x00010000 | Third enabled filter  | 0 = Within acceptable limit<br>1 = Warning |
|        | 17  | 0x00020000 |                       |  |
|        | 18  | 0x00040000 |                       |  |
|        | 19  | 0x00080000 |                       |  |
| N5     | 20  | 0x00100000 |                       |  |
|        | 21  | 0x00200000 |                       |  |
|        | 22  | 0x00400000 |                       |  |
|        | 23  | 0x00800000 |                       |  |
| N6     | 24  | 0x01000000 | Fourth enabled filter | 0 = Within acceptable limit<br>1 = Warning |
|        | 25  | 0x02000000 |                       |  |
|        | 26  | 0x04000000 |                       |  |
|        | 27  | 0x08000000 |                       |  |
| N7     | 28  | 0x10000000 |                       |  |
|        | 29  | 0x20000000 |                       |  |
|        | 30  | 0x40000000 |                       |  |
|        | 31  | 0x80000000 |                       |  |

**Table 106: Filter Switches**

| Binary Value | ASCII Value | Description     |
|--------------|-------------|-----------------|
| 0            | DISABLE     | Filter disabled |
| 1            | ENABLE      | Filter enabled  |

## 3.70 ITPROGFILTBANK

### *Allowable filter configurations*

**Platform: OEM719, OEM729, OEM7500, OEM7700, OEM7720, PwrPak7, HxGN PIM7500**

The ITPROGFILTBANK log provides information on the allowable configurations for the programmable filter for each frequency when applying either a notch filter or bandpass filter.

**Message ID: 2023**

**Log Type: Asynch**

**Recommended Input:**

```
log itprogfiltbanka once
```

**Abbreviated ASCII Example:**

```
<ITPROGFILTBANK USB1 0 88.0 FINESTEERING 1933 346362.985 12000020 3696
14137
12
GPSL1 5
NOTCHFILTER 1563.0000 1574.0000 1576.0000 1587.0000 0.05 0.15
NOTCHFILTER 1563.7500 1573.6000 1576.4000 1586.2500 0.05 0.50
NOTCHFILTER 1564.0500 1573.3000 1576.7000 1585.9500 0.05 1.00
NOTCHFILTER 1565.7500 1571.7000 1578.3000 1584.2500 0.05 2.50
BANDPASSFILTER 1563.7500 1572.5000 1577.5000 1586.2500 0.05 0.00
GPSL2 5
NOTCHFILTER 1215.5000 1226.5000 1228.5000 1239.5000 0.05 0.15
NOTCHFILTER 1216.2500 1226.1000 1228.9000 1238.7500 0.05 0.50
NOTCHFILTER 1216.5500 1225.8000 1229.2000 1238.4500 0.05 1.00
NOTCHFILTER 1218.2500 1224.2000 1230.8000 1236.7500 0.05 2.50
BANDPASSFILTER 1216.2500 1225.0000 1230.0000 1238.7500 0.05 0.00
GLONASSL1 5
NOTCHFILTER 1589.5625 1600.5625 1602.5625 1613.5625 0.05 0.15
NOTCHFILTER 1590.3125 1600.1625 1602.9625 1612.8125 0.05 0.50
NOTCHFILTER 1590.6125 1599.8625 1603.2625 1612.5125 0.05 1.00
NOTCHFILTER 1592.3125 1598.2625 1604.8625 1610.8125 0.05 2.50
BANDPASSFILTER 1590.3125 1599.0625 1604.0625 1612.8125 0.05 0.00
...
```

| Field | Field Type            | Description  | Format | Binary Bytes | Binary Offset |
|-------|-----------------------|--|--------|--------------|---------------|
| 1     | ITPROGFILTBANK header | Log header. See <i>Messages</i> on page 25 for more information. | -      | H            | 0             |

| Field | Field Type  | Description  | Format | Binary Bytes | Binary Offset |
|-------|---|--|--------|--------------|---------------|
| 2     | # entries   | Number of entries to follow  | Ulong  | 4            | H             |
| 3     | frequency   | See <i>Table 48: Frequency Types</i> on page 210   | Enum   | 4            | H+4           |
| 4     | # prog filters  | Number of programmable filters applied with information to follow  | Ulong  | 4            | H+8           |
| 5     | mode  | Programmable filter mode (notch filter or bandpass)<br>(see <i>Table 46: Programmable Filter Mode</i> on page 207) | Enum   | 4            | H+12          |
| 6     | min lower frequency cutoff  | The minimum frequency cutoff at the lower end (MHz)  | Float  | 4            | H+16          |
| 7     | max lower frequency cutoff  | The maximum frequency cutoff at the lower end (MHz)  | Float  | 4            | H+20          |
| 8     | min upper frequency cutoff  | The minimum frequency cutoff at the upper end (MHz)  | Float  | 4            | H+24          |
| 9     | max upper frequency cutoff  | The maximum frequency cutoff at the upper end (MHz)  | Float  | 4            | H+28          |
| 10    | frequency step  | The minimum cut off frequency resolution (MHz)   | Float  | 4            | H+32          |
| 11    | notch width   | Width of notch filter (MHz)  | Float  | 4            | H+36          |
| 12    | H+4+(#entries x 4) + 4 + (#progfilters x 28)                          |  |        |              |               |
| 13    | H+4+(#entries x 4) + 4 + SUM(#progfilters x 28) <sub>0-#entries</sub> |  |        |              |               |
| 14    | xxxx  | 32-bit CRC (ASCII and Binary only)   | Ulong  | 4            | variable      |
| 15    | [CR][LF]  | Sentence terminator (ASCII only)   |        |              |               |

## 3.71 ITPSDFINAL

### *Processed power spectral density*

**Platform: OEM719, OEM729, OEM7500, OEM7700, OEM7720, PwrPak7, HxGN PIM7500**

The ITPSDFINAL log contains the samples for the spectral analysis. The rate and size is set by the update period and the FFT size respectively when issuing the **ITSPECTRALANALYSIS** command (see page 208). The number of samples in each log is calculated by dividing the FFT samples by 2. For instance, FFT size of 1K will have 1 log with 512 samples; FFT size of 64K will have 32 logs with 1024 samples. This is due to the symmetrical nature of the FFT samples. The output logs can be grouped together through the sequence number of the log header.

PSD samples are compressed into 2 byte samples to reduce log sizes. The range of values that can be displayed is -200 dBm to +56 dBm with a 1/256 resolution. The following steps should be performed on the PSD samples in this log to convert them back into dBm units for display purposes:

1. Divide the sample by 256.0
2. Subtract 200



As the data rate for the ITPSDFINAL log is dictated by the updateperiod parameter in the **ITSPECTRALANALYSIS** command (see page 208), do not use ONTIME to log this message. Instead use ONNEW to log ITPSDFINAL.



The pre-decimation spectrum shows the absolute power in dBm. The post-decimation and post-filter spectrum shows the signal magnitude in relative power (dB).



The reported spectrum level can be interpreted in an unit of dBm / RBW (resolution bandwidth) referred to the receiver input.  
For the L1/L2/L5 path,  $RBW \text{ in Hz} = 2e^8 / \text{FFT size}$ .

**Message ID: 1968**

**Log Type: Asynch**

**Recommended Input:**

```
log itpsdfinalb onnew
```

**ASCII Example**

```
#ITPSDFINALA, UNKNOWN, 0, 66.0, FINESTEERING, 1891, 166978.221, 02040000, b79a
, 32768; 1310752, 1531.250, 195312.500, 512, 28033, 30370, 30225, 29190, 27254, 2
9521, 32694, 33025, 28553, 28902, 29060, 26663, 30267, 30054,
```

...



34027,38038,31082,29418,28805,27373,27869,28847,28331,31901,30251,33625,33625\*000b928d

| Field | Field Type                      | Description   | Format | Binary Bytes | Binary Offset      |
|-------|---------------------------------|---|--------|--------------|--------------------|
| 1     | ITPSDFINAL header               | Log header. See <i>Messages</i> on page 25 for more information.  | -      | H            | 0                  |
| 2     | status word                     | Status word containing information about the configuration of the spectral analysis (see <i>Table 107: Spectral Analysis Status Word</i> below) | Ulong  | 4            | H                  |
| 3     | frequency start                 | Frequency represented by first data sample (MHz)  | Float  | 4            | H+4                |
| 4     | step size                       | Frequency step for each subsequent data sample (Hz)   | Float  | 4            | H+8                |
| 5     | # samples                       | Number of spectral density samples  | Ulong  | 4            | H+12               |
| 6     | sample                          | Power spectral density sample   | Ushort | 2            | H+16               |
| 7     | Next sample = H+16+(2*#samples) |   |        |              |                    |
| 8     | xxxx                            | 32-bit CRC (ASCII and Binary only)  | Ulong  | 4            | H+16+(2*# samples) |
| 9     | [CR][LF]                        | Sentence terminator (ASCII only)  | -      | -            | -                  |

**Table 107: Spectral Analysis Status Word**

| Nibble | Bit | Mask       | Description | Range Value  |
|--------|-----|------------|-------------|--|
| N0     | 0   | 0x00000001 | Frequency   | 0 – 20<br>See <i>Table 48: Frequency Types</i> on page 210             |
|        | 1   | 0x00000002 |             |  |
|        | 2   | 0x00000004 |             |  |
|        | 3   | 0x00000008 |             |  |
| N1     | 4   | 0x00000010 | Data Source | 0 – 3<br>See <i>Table 47: Data Sources for PSD Samples</i> on page 209 |
|        | 5   | 0x00000020 |             |  |
|        | 6   | 0x00000040 |             |  |
|        | 7   | 0x00000080 |             |  |

| Nibble | Bit | Mask       | Description         | Range Value                                  |
|--------|-----|------------|---------------------|--|
| N2     | 8   | 0x00000100 | FFT Size            | 0 – 6<br>See Table 49: FFT Sizes on page 211 |
|        | 9   | 0x00000200 |                     |  |
|        | 10  | 0x00000400 |                     |  |
|        | 11  | 0x00000800 |                     |  |
| N3     | 12  | 0x00001000 | Subcarrier Window   | 0 – 30 samples                               |
|        | 13  | 0x00002000 |                     |  |
|        | 14  | 0x00004000 |                     |  |
|        | 15  | 0x00008000 |                     |  |
| N4     | 16  | 0x00010000 | Time Average Window | 0 – 100 seconds                              |
|        | 17  | 0x00020000 |                     |  |
|        | 18  | 0x00040000 |                     |  |
|        | 19  | 0x00080000 |                     |  |
| N5     | 20  | 0x00100000 | Reserved            |  |
|        | 21  | 0x00200000 |                     |  |
|        | 22  | 0x00400000 |                     |  |
|        | 23  | 0x00800000 |                     |  |
| N6     | 24  | 0x01000000 | Reserved            |  |
|        | 25  | 0x02000000 |                     |  |
|        | 26  | 0x04000000 |                     |  |
|        | 27  | 0x08000000 |                     |  |
| N7     | 28  | 0x10000000 | Reserved            |  |
|        | 29  | 0x20000000 |                     |  |
|        | 30  | 0x40000000 |                     |  |
|        | 31  | 0x80000000 |                     |  |

## 3.72 J1939STATUS

### Status of CAN J1939 Node

**Platform: OEM719, OEM729, OEM7500, OEM7700, OEM7720, PwrPak7, HxGN PIM7500**

This logs reports the status of J1939 node, specifically J1939 Address Claim function (initiated using the **J1939CONFIG** command (see page 212)).

This log displays the status only for nodes that have been set.

**Message ID: 1907**

**Log Type: Asynch**

**Recommended Input:**

```
LOG J1939STATUSA ONCHANGED
```

**ASCII Examples:**

```
#J1939STATUSA,COM1,1,81.0,UNKNOWN,0,0.000,02004020,e9ce,32768;NODE1,DISABLED,0,FE*637c7f
```

```
#J1939STATUSA,COM1,0,81.0,UNKNOWN,0,0.000,02004020,e9ce,32768;NODE2,DISABLED,0,FE*c41af5ee
```

| Field | Field Type         | Description  | Format | Binary Bytes | Binary Offset |
|-------|--------------------|--|--------|--------------|---------------|
| 1     | J1939STATUS header | Log header. See <i>Messages</i> on page 25 for more information.   | -      | H            | 0             |
| 2     | node               | J1939 Node. The node can be either NODE1 or NODE2.   | Enum   | 4            | H             |
| 3     | status             | Node status. See <i>Table 108: Node Status</i> on the next page  | Enum   | 4            | H+4           |
| 4     | count              | Number of attempts that were made to claim address.<br>This will be 1 when the preferred address is used and may be more if the alternate range is used. | Ulong  | 4            | H+8           |
| 5     | address            | Claimed CAN Address.<br>0xFE (NULL address) if the address could not be negotiated.  | Uchar  | 1            | H+12          |
| 6     | xxxx               | 32-bit CRC (ASCII and Binary only)   | Hex    | 4            | H+13          |
| 7     | [CR][LF]           | Sentence Terminator (ASCII only)   | -      | -            | -             |

**Table 108: Node Status**

| <b>Value</b> | <b>ASCII</b> | <b>Description</b>  |
|--------------|--------------|---|
| 1            | DISABLED     | Address claim activity is not taking place. The node does not have J1939 enabled. |
| 2            | CLAIMING     | Address claim procedure is in progress.   |
| 3            | CLAIMED      | Address claimed successfully. Ready for data transfer.                            |
| 4            | FAILED       | Address claim was not successful. No further activity is taking place.            |

## 3.73 LBANDBEAMTABLE

### List of L-Band beams

**Platform: OEM719, OEM729, OEM7500, OEM7700, OEM7720, PwrPak7, HxGN PIM7500**

This log lists the TerraStar and Veripos L-Band beams known to the receiver.

**Message ID: 1718**

**Log Type: Asynch**

**Recommended Input:**

```
log lbandbeamtablea onchanged
```

**Abbreviated ASCII Example:**

```
<LBANDBEAMTABLE COM1 0 74.5 UNKNOWN 0 0.151 02440000 f3b2 45228
< 7
< "AORE" "A" 1539982500 1200 -15.50 1
< "AORW" "B" 1539892500 1200 -54.00 1
< "IOR" "C" 1539902500 1200 64.50 1
< "POR" "D" 1539942500 1200 178.00 1
< "25E" "E" 1539882500 1200 25.00 1
< "143.5E" "F" 1539992500 1200 143.50 1
< "98W" "G" 1539902500 1200 -98.00 1
```

| Field | Field type                                 | Description  | Format  | Binary Bytes | Binary Offset |
|-------|--|--|---------|--------------|---------------|
| 1     | LBANDBEAMTABLE header                      | Log header. See <i>Messages</i> on page 25 for more information. |         | H            | 0             |
| 2     | #entries                                   | Number of records to follow                                      | Ulong   | 4            | H             |
| 3     | Name                                       | Beam/transmitting satellite name                                 | Char[8] | 8            | H+4           |
| 4     | Reserved                                   |  | Char[8] | 8            | H+12          |
| 5     | Frequency                                  | Frequency (Hz)   | Ulong   | 4            | H+20          |
| 6     | Baud                                       | Baud rate  | Ulong   | 4            | H+24          |
| 7     | Longitude                                  | Transmitting satellite longitude (degrees)                       | Float   | 4            | H+28          |
| 8     | Access                                     | Beam service availability flag<br>0 = Denied<br>1 = Granted      | Ulong   | 4            | H+32          |
| 9     | Next beam offset = H + 4 + (#entries x 32) |  |         |              |               |

---

| <b>Field</b> | <b>Field type</b> | <b>Description</b>                 | <b>Format</b> | <b>Binary Bytes</b> | <b>Binary Offset</b>       |
|--------------|-------------------|------------------------------------|---------------|---------------------|----------------------------|
| 10           | xxxx              | 32-bit CRC (ASCII and Binary only) | Ulong         | 4                   | H+4+<br>(#entries<br>x 32) |
| 11           | [CR][LF]          | Sentence terminator (ASCII only)   | -             | -                   | -                          |

## 3.74 LBANDDRAWFRAME

### *Raw L-Band frame data*

**Platform: OEM719, OEM729, OEM7500, OEM7700, OEM7720, PwrPak7, HxGN PIM7500**

This log contains the raw L-Band frame data.



Use of an L-Band correction service, such as TerraStar, and an L-Band compatible antenna is required.

**Message ID: 2069**

**Log Type: Asynch**

**Recommended Input:**

```
log lbanddrawframe onnew
```

**Abbreviated ASCII Example:**

```
LBANDDRAWFRAME COM1 0 86.0 FINESTEERING 1916 250722.715 02000020 b199
32768
< "AORW" 974c 63 e5adc25f2c60ec13c4e33b668131fb33e1fd751657052f4df
58965eeb797960cfb391091cdaab6d8c3ba00f1300f4c1137163654e449f4a894480b1
9358f99

[COM1]<LBANDDRAWFRAME COM1 0 86.0 FINESTEERING 1916 250722.808 02000020
b199 32768
< "POR" 974c 56 45e1e4cb93482fd01bccb36eab36573f1271eb603ffd425e2
7afcdac9c5b10c68f4cbfc416b028002844717946a6f3f41d3469c5659ac7ec

[COM1]<LBANDDRAWFRAME COM1 0 85.5 FINESTEERING 1916 250722.912 02000020
b199 32768
< "98W" 974c 64 7317da86f0c362d80e09c011848a578b75780db2aee384a2b
f356e7e18beba614a2f03022d98a31146a8dc581429700fb80d000946c6cf8e
f41a2e69c5213246
```

| Field | Field type            | Description  | Format  | Binary Bytes | Binary Offset |
|-------|-----------------------|--|---------|--------------|---------------|
| 1     | LBANDDRAWFRAME header | Log header. See <i>Messages</i> on page 25 for more information. | -       | H            | 0             |
| 2     | Beam Name             | Beam Name  | Char[8] | 8            | H             |
| 3     | Service ID            | Service ID   | Ushort  | 2            | H+8           |
| 4     | #bytes                | Number of bytes to follow  | Ulong   | 4            | H+10          |
| 5     | data packet           | Raw L-Band data packet   | Hex[64] | 64           | H+14          |

| <b>Field</b> | <b>Field type</b> | <b>Description</b>                 | <b>Format</b> | <b>Binary Bytes</b> | <b>Binary Offset</b> |
|--------------|-------------------|------------------------------------|---------------|---------------------|----------------------|
| 6            | xxxx              | 32-bit CRC (ASCII and Binary only) | Ulong         | 4                   | H+14+<br>#bytes      |
| 7            | [CR][LF]          | Sentence terminator (ASCII only)   | -             | -                   | -                    |



## 3.75 LBANDTRACKSTAT

### *L-Band Beams status*

**Platform: OEM719, OEM729, OEM7500, OEM7700, OEM7720, PwrPak7, HxGN PIM7500**

This log reports the L-Band tracking and Viterbi decoding status for the tracked L-Band beams.



The maximum logging rate for LBANDTRACKSTAT is 2 Hz.

**Message ID: 1201**

**Log Type: Synch**

**Recommended Input:**

```
log lbandtrackstata ontime 1
```

**ASCII Example:**

```
#LBANDTRACKSTATA, COM1, 0, 55.0, FINESTEERING, 1986, 508568.000, 03000000,
29fd, 32768; 3,
"98W", 1539902500, 1200, 974c, 00c2, 0, 118.555, 41.413, 3.6993, 69389.711,
1321664, 113, 113, 169172992, 11973, 0.0001,
"AORW", 1539892500, 1200, 974c, 00c2, 0, 175.236, 39.222, 2.7057, 1832707.625,
34908672, 366868, 253025, 173342720, 44042933, 0.0057,
"POR", 1539942500, 1200, 974c, 00c2, 0, -115.333, 33.383, 1.4153, 54592.406,
1039808, 47156, 14616, 133095424, 5786206, 0.1199*d009640f
```

| Field | Field type            | Description  | Format  | Binary Bytes | Binary Offset |
|-------|-----------------------|--|---------|--------------|---------------|
| 1     | LBANDTRACKSTAT header | Log header. See <i>Messages</i> on page 25 for more information.                           |         | H            | 0             |
| 2     | #entries              | Number of records to follow  | Ulong   | 4            | H             |
| 3     | Name                  | Beam/transmitting satellite name   | Char[8] | 8            | H+4           |
| 4     | Frequency             | Frequency assigned to this L-Band beam (Hz)  | Ulong   | 4            | H+12          |
| 5     | Baud rate             | Baud rate of assigned beam   | Ushort  | 2            | H+16          |
| 6     | ID                    | Service ID of the assigned beam  | Ushort  | 2            | H+18          |
| 7     | Status                | Tracking status word. See <i>Table 109: L-Band Signal Tracking Status</i> on the next page | Ushort  | 2            | H+20          |
| 8     | Reserved              | Reserved   | Ushort  | 2            | H+22          |

| Field | Field type                                  | Description                                | Format | Binary Bytes | Binary Offset        |
|-------|---|--|--------|--------------|----------------------|
| 9     | Doppler                                     | Signal Doppler (Hz)                        | Float  | 4            | H+24                 |
| 10    | C/No  | Carrier to noise density ratio (dB-Hz)     | Float  | 4            | H+28                 |
| 11    | Std. Dev.                                   | Phase error standard deviation (cycles)    | Float  | 4            | H+32                 |
| 12    | Lock time                                   | Lock time (seconds)                        | Float  | 4            | H+36                 |
| 13    | Unique word bits                            | Total unique word bits                     | Ulong  | 4            | H+40                 |
| 14    | Bad unique word bits                        | Bad unique word bits                       | Ulong  | 4            | H+44                 |
| 15    | Bad unique words                            | Bad unique words                           | Ulong  | 4            | H+48                 |
| 16    | Viterbi symbols                             | Total Viterbi symbols                      | Ulong  | 4            | H+52                 |
| 17    | Corrected Viterbi                           | Corrected Viterbi symbols                  | Ulong  | 4            | H+56                 |
| 18    | BER   | Estimated pre-Viterbi Bit Error Rate (BER) | Float  | 4            | H+60                 |
| 19    | Next entry offset = H + 4 + (#entries x 60) |  |        |              |                      |
| 20    | xxxx  | 32-bit CRC (ASCII and Binary only)         | Hex    | 4            | H+4+ (#entries x 60) |
| 21    | [CR][LF]                                    | Sentence terminator (ASCII only)           | -      | -            | -                    |

**Table 109: L-Band Signal Tracking Status**

| Nibble | Bit | Mask   | Description    | Range Value   |
|--------|-----|--------|----------------|---|
| NO     | 0   | 0x0001 | Tracking State | 0 = Searching,<br>1 = Pull-in,<br>2 = Tracking,<br>3 = Idle |
|        | 1   | 0x0002 |                |   |
|        | 2   | 0x0004 | Reserved       |   |
|        | 3   | 0x0008 |                |   |

| <b>Nibble</b> | <b>Bit</b> | <b>Mask</b> | <b>Description</b> | <b>Range Value</b>            |
|---------------|------------|-------------|--------------------|-------------------------------|
| N1            | 4          | 0x0010      |                    |                               |
|               | 5          | 0x0020      |                    |                               |
|               | 6          | 0x0040      | Bit Timing Lock    | 0 = Not Locked,<br>1 = Locked |
|               | 7          | 0x0080      | Phase Locked       | 0 = Not Locked,<br>1 = Locked |
| N2            | 8          | 0x0100      | DC Offset Unlocked | 0 = Good,<br>1 = Warning      |
|               | 9          | 0x0200      | AGC Unlocked       | 0 = Good,<br>1 = Warning      |
|               | 10         | 0x0400      | Reserved           |                               |
|               | 11         | 0x0800      |                    |                               |
| N3            | 12         | 0x1000      |                    |                               |
|               | 13         | 0x2000      |                    |                               |
|               | 14         | 0x4000      |                    |                               |
|               | 15         | 0x8000      | Error              | 0 = Good,<br>1 = Error        |

## 3.76 LOGLIST

### *List of system logs*

**Platform: OEM719, OEM729, OEM7500, OEM7700, OEM7720, PwrPak7, HxGN PIM7500**

This log outputs a list of log entries in the system. The following tables show the binary and ASCII output. See also the **RXCONFIG** log on page 732 for a list of current command settings.

**Message ID: 5**

**Log Type: Polled**

**Recommended Input:**

```
log loglista once
```

**ASCII Example:**

```
#LOGLISTA, COM1, 0, 60.5, FINESTEERING, 1337, 398279.996, 02000000, c00c, 1984;
8,
COM1, RXSTATUSEVENTA, ONNEW, 0.000000, 0.000000, HOLD,
COM2, RXSTATUSEVENTA, ONNEW, 0.000000, 0.000000, HOLD,
COM3, RXSTATUSEVENTA, ONNEW, 0.000000, 0.000000, HOLD,
USB1, RXSTATUSEVENTA, ONNEW, 0.000000, 0.000000, HOLD,
USB2, RXSTATUSEVENTA, ONNEW, 0.000000, 0.000000, HOLD,
USB3, RXSTATUSEVENTA, ONNEW, 0.000000, 0.000000, HOLD,
COM1, BESTPOSA, ONTIME, 10.000000, 0.000000, NOHOLD,
COM1, LOGLISTA, ONCE, 0.000000, 0.000000, NOHOLD*5b29eed3
```



Do not use undocumented logs or commands. Doing so may produce errors and void your warranty.

### 3.76.1 Binary

| Field | Field type              | Description  | Format | Binary Bytes | Binary Offset |
|-------|-------------------------|--|--------|--------------|---------------|
| 1     | LOGLIST (binary) header | Log header. See <i>Messages</i> on page 25 for more information.     |        | H            | 0             |
| 2     | #logs                   | Number of messages to follow, maximum = 80                           | Ulong  | 4            | H             |
| 3     | port                    | Output port, see <i>Table 4: Detailed Port Identifier</i> on page 31 | Enum   | 4            | H+4           |
| 4     | message                 | Message ID of the log  | Ushort | 2            | H+8           |

| Field    | Field type                             | Description  | Format | Binary Bytes | Binary Offset        |
|----------|--|--|--------|--------------|----------------------|
| 5        | message type                           | Bits 0-4 = Reserved<br>Bits 5-6 = Format<br>00 = Binary<br>01 = ASCII<br>10 = Abbreviated ASCII, NMEA<br>11 = Reserved<br>Bit 7 = Response Bit (see <i>Message Responses</i> on page 42)<br>0 = Original Message<br>1 = Response Message | Char   | 1            | H+10                 |
| 6        | Reserved                               |  | Char   | 1            | H+11                 |
| 7        | trigger                                | 0 = ONNEW<br>1 = ONCHANGED<br>2 = ONTIME<br>3 = ONNEXT<br>4 = ONCE<br>5 = ONMARK   | Enum   | 4            | H+12                 |
| 8        | period                                 | Log period for ONTIME  | Double | 8            | H+16                 |
| 9        | offset                                 | Offset for period (ONTIME trigger)   | Double | 8            | H+24                 |
| 10       | hold                                   | 0 = NOHOLD<br>1 = HOLD   | Enum   | 4            | H+32                 |
| 11...    | Next log offset = H + 4 + (#logs x 32) |  |        |              |                      |
| variable | xxxx                                   | 32-bit CRC   | Hex    | 4            | H+4+<br>(#logs x 32) |

### 3.76.2 ASCII

| Field | Field type             | Description   | Format   |
|-------|------------------------|---|----------|
| 1     | LOGLIST (ASCII) header | Log header. See <i>Messages</i> on page 25 for more information.  |          |
| 2     | #port                  | Number of messages to follow, maximum = 80  | Long     |
| 3     | port                   | Output port, see <i>Table 4: Detailed Port Identifier</i> on page 31                                      | Enum     |
| 4     | message                | Message name of log with no suffix for abbreviated ASCII, an A suffix for ASCII and a B suffix for binary | Char [ ] |

| Field    | Field type | Description  | Format |
|----------|------------|--|--------|
| 5        | trigger    | ONNEW<br>ONCHANGED<br>ONTIME<br>ONNEXT<br>ONCE<br>ONMARK | Enum   |
| 6        | period     | Log period for ONTIME                                    | Double |
| 7        | offset     | Offset for period (ONTIME trigger)                       | Double |
| 8        | hold       | NOHOLD<br>HOLD   | Enum   |
| 9...     | Next port  |  |        |
| variable | xxxx       | 32-bit CRC   | Hex    |
| variable | [CR][LF]   | Sentence terminator                                      | -      |

## 3.77 MARK1COUNT, MARK2COUNT, MARK3COUNT and MARK4COUNT

### *Count for the Mark inputs*

**Platform: OEM719, OEM729, OEM7500, OEM7700, OEM7720, PwrPak7, HxGN PIM7500**



These logs are only available for SPAN systems.



MARK3COUNT and MARK4COUNT are available only on OEM7700 and OEM7720 receivers.

These logs contain the tick count for the EVENT1 (MARK1COUNT), EVENT2 (MARK2COUNT), EVENT3 (MARK3COUNT) and EVENT4 (MARK4COUNT) inputs.

When the input mode is set to COUNT using the **EVENTINCONTROL** command (see page 139), the MARKxCOUNT logs become available.



Use the ONNEW trigger with this, the MARKxTIME, or the MARKxPVA logs.



Only the MARKxCOUNT, MARKxPVA logs, the MARKxTIME logs, and 'polled' log types are generated 'on the fly' at the exact time of the mark. Synchronous and asynchronous logs output the most recently available data.

**Message ID:**       **1093 (MARK1COUNT)**  
                           **1094 (MARK2COUNT)**  
                           **1095 (MARK3COUNT)**  
                           **1096 (MARK4COUNT)**

**Log Type: Asynch**

**Recommended Input:**

```
log mark1counta onnew
```

```
log mark2counta onnew
```

```
log mark3counta onnew
```

```
log mark4counta onnew
```

**ASCII Example:**

```
#MARK1COUNTA,COM1,0,98.5,FINESTEERING,1520,515353.000,02000000,0000,137;1000000,1*1786750b
```

```
#MARK2COUNTA,COM1,0,98.5,FINESTEERING,1520,515353.000,02000000,0000,137;1000000,1*1786750b
```

```
#MARK3COUNTA,COM1,0,98.5,FINESTEERING,1520,515353.000,02000000,0000,137;1000000,1*1786750b
```

```
#MARK4COUNTA,COM1,0,98.5,FINESTEERING,1520,515353.000,02000000,0000,137;1000000,1*1786750b
```

| Field | Field Type  | Description  | Format | Binary Bytes | Binary Offset |
|-------|---|--|--------|--------------|---------------|
| 1     | MARK1COUNT,<br>MARK2COUNT,<br>MARK3COUNT,<br>MARK4COUNT<br>header | Log header. See <i>Messages</i> on page 25 for more information. |        | H            | 0             |
| 2     | Period  | Delta time (microseconds)  | Ulong  | 4            | H             |
| 3     | Count   | Tick count   | Ushort | 2            | H+4           |
| 4     | xxxx  | 32-bit CRC (ASCII and Binary only)                               | Hex    | 4            | H+6           |
| 5     | [CR][LF]  | Sentence terminator (ASCII only)                                 | -      | -            | -             |



## 3.78 MARKPOS, MARK2POS, MARK3POS and MARK4POS

### *Position at time of mark input event*

**Platform: OEM719, OEM729, OEM7500, OEM7700, OEM7720, PwrPak7, HxGN PIM7500**

This log contains the estimated position of the antenna when a pulse is detected at a mark input. MARKPOS is generated when a pulse occurs on the MK1I input. MARK2POS is generated when a pulse occurs on the MK2I input. MARK3POS is generated when a pulse occurs on the MK3I input (OEM7700 and OEM7720 only). MARK4POS is generated when a pulse occurs on the MK4I input (OEM7700 and OEM7720 only). Refer to the product specific *Technical Specifications* appendices in the [OEM7 Installation and Operation User Manual](#) for mark input pulse specifications and the location of the mark input pins.

The position at the mark input pulse is extrapolated using the last valid position and velocities. The latched time of mark impulse is in GPS reference weeks and seconds into the week. The resolution of the latched time is 10 ns. See also the notes on MARKPOS in the **MARKTIME, MARK2TIME, MARK3TIME and MARK4TIME** log on page 572.

**Message ID:**       **181 (MARKPOS)**  
                       **615 (MARK2POS)**  
                       **1738 (MARK3POS)**  
                       **1739 (MARK4POS)**

**Log Type: Asynch**

**Recommended Input:**

log markposa onnew





1. Use the ONNEW trigger with the MARKTIME or MARKPOS logs.
2. Refer to the *Technical Specifications* appendix in the [OEM7 Installation and Operation User Manual](#) for more details on the MK1I pin. ONMARK only applies to MK1I. Events on MK2I (if available) do not trigger logs when ONMARK is used. Use the ONNEW trigger with the MARKTIME, MARK2TIME, MARKPOS or MARK2POS logs.
3. Once the 1PPS signal has hit a rising edge, for both MARKPOS and MARKTIME logs, a resolution of both measurements is 10 ns. As for the ONMARK trigger for other logs that measure latency, for example RANGE and POSITION logs such as BESTPOS, it takes typically 20-30 ms (50 ms maximum) for the logs to output information from the 1PPS signal. Latency is the time between the reception of the 1PPS pulse and the first byte of the associated log. See also the **MARKTIME, MARK2TIME, MARK3TIME and MARK4TIME** log on page 572.

**Abbreviated ASCII Example:**

```
<MARKPOS COM1 0 89.0 FINESTEERING 1670 413138.000 02000020 c223 42770
SOL_COMPUTED SINGLE 51.11289233689 -114.02932170726 1018.9653 1049.4915
BUKIT 1.9372 1.1981 4.0909 "" 0.000 0.000 19 18 18 18 0 06 0 33
```

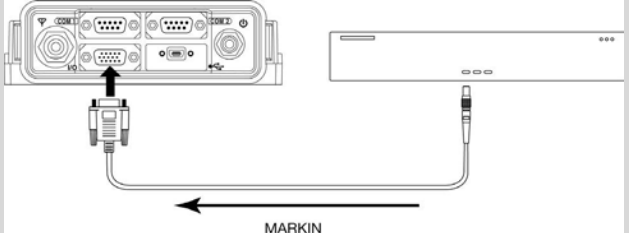
 Consider the case where you have a user point device such as video equipment. Connect the device to the receiver's I/O port using a cable that is compatible to both the receiver and the device. Refer to your device's documentation for information about connectors and cables. The arrow along the cable in the figure below indicates a MARKIN pulse, from the user device on the right to the receiver I/O port.



| Field | Field type   | Description  | Format | Binary Bytes | Binary Offset |
|-------|--|--|--------|--------------|---------------|
| 1     | MARKPOS/<br>MARK2POS/<br>MARK3POS/<br>MARK4POS<br>header | Log header. See <i>Messages</i> on page 25 for more information.   |        | H            | 0             |
| 2     | sol status   | Solution status (see <i>Table 73: Solution Status</i> on page 419)   | Enum   | 4            | H             |
| 3     | pos type   | Position type (see <i>Table 74: Position or Velocity Type</i> on page 420)   | Enum   | 4            | H+4           |
| 4     | lat  | Latitude (degrees)   | Double | 8            | H+8           |
| 5     | lon  | Longitude (degrees)  | Double | 8            | H+16          |
| 6     | hgt  | Height above mean sea level (m)  | Double | 8            | H+24          |
| 7     | undulation   | Undulation - the relationship between the geoid and the WGS84 ellipsoid (m)<br><div style="border: 1px solid black; padding: 5px; margin-top: 10px;">  When using a datum other than WGS84, the undulation value also includes the vertical shift due to differences between the datum in use and WGS84.                 </div> | Float  | 4            | H+32          |
| 8     | datum id#  | Datum ID number (refer to <i>Table 28: Datum Transformation Parameters</i> on page 116)  | Enum   | 4            | H+36          |
| 9     | lat $\sigma$   | Latitude standard deviation (m)  | Float  | 4            | H+40          |
| 10    | lon $\sigma$   | Longitude standard deviation (m)   | Float  | 4            | H+44          |

| Field | Field type                  | Description   | Format  | Binary Bytes | Binary Offset |
|-------|-----------------------------|---|---------|--------------|---------------|
| 11    | hgt $\sigma$                | Height standard deviation (m)   | Float   | 4            | H+48          |
| 12    | stn id                      | Base station ID   | Char[4] | 4            | H+52          |
| 13    | diff_age                    | Differential age in seconds   | Float   | 4            | H+56          |
| 14    | sol_age                     | Solution age in seconds   | Float   | 4            | H+60          |
| 15    | #SVs                        | Number of satellites tracked  | Uchar   | 1            | H+64          |
| 16    | #solnSVs                    | Number of satellite vehicles used in solution   | Uchar   | 1            | H+65          |
| 17    | #ggL1                       | Number of satellites with L1/E1/B1 signals used in solution   | Uchar   | 1            | H+66          |
| 18    | #solnMultiSVs               | Number of satellites with multi-frequency signals used in solution  | Uchar   | 1            | H+67          |
| 19    | Reserved                    |   | Uchar   | 1            | H+68          |
| 20    | ext sol stat                | Extended solution status (see <i>Table 77: Extended Solution Status</i> on page 423)                        | Hex     | 1            | H+69          |
| 21    | Galileo and BeiDou sig mask | Galileo and BeiDou signals used mask (see <i>Table 76: Galileo and BeiDou Signal-Used Mask</i> on page 423) | Hex     | 1            | H+70          |
| 22    | GPS and GLONASS sig mask    | GPS and GLONASS signals used mask (see <i>Table 75: GPS and GLONASS Signal-Used Mask</i> on page 422)       | Hex     | 1            | H+71          |
| 23    | xxxx                        | 32-bit CRC (ASCII and Binary only)  | Hex     | 4            | H+72          |
| 24    | [CR][LF]                    | Sentence terminator (ASCII only)  | -       | -            | -             |

## 3.79 MARKTIME, MARK2TIME, MARK3TIME and MARK4TIME

### *Time of mark input event*

**Platform: OEM719, OEM729, OEM7500, OEM7700, OEM7720, PwrPak7, HxGN PIM7500**

This log contains the time of the leading edge of the detected mark input pulse.

- MARKTIME is generated when a pulse occurs on a MK1I input
- MARK2TIME is generated when a pulse occurs on a MK2I input
- MARK3TIME is generated when a pulse occurs on a MK3I input (OEM7700 and OEM7720 only)
- MARK4TIME is generated when a pulse occurs on a MK4I input (OEM7700 and OEM7720 only)

Refer to the *Technical Specifications* appendix in the [OEM7 Installation and Operation User Manual](#) for mark input pulse specifications and the location of the mark input pins. The resolution of this measurement is 10 ns.



1. Use the ONNEW trigger with the MARKTIME or the MARKPOS logs.
2. Only the MARKPOS logs, MARKTIME logs and 'polled' log types are generated 'on the fly' at the exact time of the mark. Synchronous and asynchronous logs output the most recently available data.
3. Refer to the *Technical Specifications* appendix in the [OEM7 Installation and Operation User Manual](#) for more details on the MK1I pin. ONMARK only applies to MK1I. Events on MK2I (if available) do not trigger logs when ONMARK is used. Use the ONNEW trigger with the MARKTIME, MARK2TIME, MARKPOS or MARK2POS logs.
4. Once the 1PPS signal has hit a rising edge, for both MARKPOS and MARKTIME logs, a resolution of both measurements is 10 ns. As for the ONMARK trigger for other logs that measure latency, for example RANGE and POSITION logs such as BESTPOS, it takes typically 20-30 ms (50 ms maximum) for the logs to output information from the 1PPS signal. Latency is the time between the reception of the 1PPS pulse and the first byte of the associated log. See also the **MARKPOS, MARK2POS, MARK3POS and MARK4POS** log on page 569.

**Message ID:**       **231 (MARKTIME)**  
                           **616 (MARK2TIME)**  
                           **1075 (MARK3TIME)**  
                           **1076 (MARK4TIME)**

**Log Type: Asynch**

**Recommended Input:**

```
log marktimea onnew
```

**ASCII Example:**

```
#MARKTIMEA,COM1,0,77.5,FINESTEERING,1358,422621.000,02000000,292e,2214  
;1358,422621.000000500,-1.398163614e-08,7.812745577e-08,-  
14.000000002,VALID*d8502226
```



These logs allow you to measure the time when events are occurring in other devices (such as a video recorder). See also the **MARKCONTROL** command on page 228.

| Field | Field type   | Description  | Format | Binary Bytes | Binary Offset |
|-------|--|--|--------|--------------|---------------|
| 1     | MARKTIME/<br>MARK2TIME/<br>MARK3TIME/<br>MARK4TIME<br>header | Log header. See <i>Messages</i> on page 25 for more information.   |        | H            | 0             |
| 2     | week   | GPS reference week number  | Long   | 4            | H             |
| 3     | seconds  | Seconds into the week as measured from the receiver clock, coincident with the time of electrical closure on the Mark Input port   | Double | 8            | H+4           |
| 4     | offset   | Receiver clock offset, in seconds. A positive offset implies that the receiver clock is ahead of GPS reference time. To derive GPS reference time, use the following formula:<br>GPS reference time = receiver time - (offset)   | Double | 8            | H+12          |
| 5     | offset std   | Standard deviation of receiver clock offset (s)  | Double | 8            | H+20          |
| 6     | utc offset   | This field represents the offset of GPS reference time from UTC time (s), computed using almanac parameters. UTC time is GPS reference time plus the current UTC offset plus the receiver clock offset.<br>UTC time = GPS reference time + offset + UTC offset<br><br><div style="border: 1px solid black; padding: 5px; width: fit-content; margin: 10px auto;">  0 indicates that UTC time is unknown because there is no almanac available in order to acquire the UTC offset. </div> | Double | 8            | H+28          |
| 7     | status   | Clock model status, see <i>Table 86: Clock Model Status</i> on page 446  | Enum   | 4            | H+36          |
| 8     | xxxx   | 32-bit CRC (ASCII and Binary only)   | Ulong  | 4            | H+40          |
| 9     | [CR][LF]   | Sentence terminator (ASCII only)   | -      | -            | -             |

## 3.80 MASTERPOS

### *Master Position using ALIGN*

**Platform: OEM719, OEM729, OEM7500, OEM7700, OEM7720, PwrPak7, HxGN PIM7500**

ALIGN generates distance and bearing information between a Master and Rover receiver. This log outputs the position information of the master when using the ALIGN feature. This log can be output from both Y and Z ALIGN models and can be output at both Master and Rover ends.



You must have an ALIGN capable receiver to use this log.



1. ALIGN is useful for obtaining the relative directional heading of a vessel/body, separation heading between two vessels/bodies or heading information with moving base and pointing applications.
2. The log can be output at both Y and Z model Rover if it is receiving the RTCAREFEXT or NovAtelXRef message from the Master. The log can be output at any Master if the Master is receiving HEADINGEXTB or HEADINGEXT2B from the Rover. Refer to the NovAtel application note [APN-048](#) for details on HEADINGEXT (available on our website at [www.novatel.com/support/](http://www.novatel.com/support/).)
3. MASTERPOS logging is dictated by the output frequency of the RTCAREFEXT or NovAtelXRef output frequency.

**Message ID: 1051**

**Log Type: Asynch**

**Recommended Input:**

```
log masterposa onchanged
```

**ASCII Example:**

```
#MASTERPOSA,COM1,0,21.5,FINESTEERING,1544,340322.000,02000008,5009,465
5;SOL_COMPUTED,NARROW_INT,51.11604599076,-114.03855412002,1055.7756,
16.9000,WGS84,0.0090,0.0086,0.0143,"AAAA",0.0,0.0,13,13,13,12,0,0,0,0*
a72e8d3f
```



Asynchronous logs, such as MASTERPOS, should only be logged ONCHANGED or ONNEW otherwise, the most current data is not output when it is available. This is especially true of the ONTIME trigger, which may cause inaccurate time tags to result.

| Field | Field Type       | Description   | Format  | Binary Bytes | Binary Offset |
|-------|------------------|---|---------|--------------|---------------|
| 1     | MASTERPOS header | Log header. See <i>Messages</i> on page 25 for more information.                        |         | H            | 0             |
| 2     | sol stat         | Solution Status, see <i>Table 73: Solution Status</i> on page 419                       | Enum    | 4            | H             |
| 3     | pos type         | Position Type see <i>Table 74: Position or Velocity Type</i> on page 420                | Enum    | 4            | H+4           |
| 4     | lat              | Master WGS84 Latitude in degrees  | Double  | 8            | H+8           |
| 5     | long             | Master WGS84 Longitude in degrees   | Double  | 8            | H+16          |
| 6     | hgt              | Master MSL Height in metres   | Double  | 8            | H+24          |
| 7     | undulation       | Undulation in metres  | Float   | 4            | H+32          |
| 8     | datum id#        | WGS84 (default) (refer to <i>Table 28: Datum Transformation Parameters</i> on page 116) | Enum    | 4            | H+36          |
| 9     | lat $\sigma$     | Latitude standard deviation in metres   | Float   | 4            | H+40          |
| 10    | long $\sigma$    | Longitude standard deviation in metres  | Float   | 4            | H+44          |
| 11    | hgt $\sigma$     | Height standard deviation in metres   | Float   | 4            | H+48          |
| 12    | stn id           | Receiver ID can be set using the <b>DGPSTXID</b> command (see page 121)                 | Char[4] | 4            | H+52          |
| 13    | Reserved         |   | Float   | 4            | H+56          |
| 14    |                  |   | Float   | 4            | H+60          |
| 15    | #SVs             | Number of satellite vehicles tracked  | Uchar   | 1            | H+64          |
| 16    | #solnSVs         | Number of satellite vehicles used in solution   | Uchar   | 1            | H+65          |
| 17    | #obs             | Number of satellites with L1/E1/B1 signals used in solution                             | Uchar   | 1            | H+66          |
| 18    | #multi           | Number of satellites with multi-frequency signals used in solution                      | Uchar   | 1            | H+67          |
| 19    | sol source       | Solution source (see <i>Table 101: Solution Source</i> on page 528)                     | Hex     | 1            | H+68          |
| 20    | Reserved         |   | Uchar   | 1            | H+69          |
| 21    |                  |   | Uchar   | 1            | H+70          |
| 22    |                  |   | Uchar   | 1            | H+71          |
| 23    | xxxx             | 32-bit CRC (ASCII and Binary only)  | HEX     | 1            | H+72          |
| 24    | [CR][LF]         | Sentence Terminator (ASCII only)  | -       | -            | -             |

## 3.81 MATCHEDPOS

### *Matched RTK position*

**Platform: OEM719, OEM729, OEM7500, OEM7700, OEM7720, PwrPak7, HxGN PIM7500**

This log represents positions that have been computed from time matched base and rover observations. There is no base extrapolation error on these positions because they are based on buffered measurements, that is, they lag real time by some amount depending on the latency of the data link. If the rover receiver has not been enabled to accept RTK differential data or is not actually receiving data leading to a valid solution, this is shown in fields #2 (*sol status*) and #3 (*pos type*).

This log provides the best accuracy in static operation. For lower latency in kinematic operation, see the **RTKPOS** log (see page 722) or **BESTPOS** log (see page 416). The data in the logs changes only when a base observation (RTCMv3) changes.

A good message trigger for this log is `onchanged`. Then, only positions related to unique base station messages are produced and the existence of this log indicates a successful link to the base.



Asynchronous logs, such as **MATCHEDPOS**, should only be logged `ONCHANGED` otherwise the most current data is not output when it is available. This is especially true of the `ONTIME` trigger, which may cause inaccurate time tags to result.



The RTK system in the receiver provides two kinds of position solutions. The Matched RTK position is computed with buffered observations, so there is no error due to the extrapolation of base station measurements. This provides the highest accuracy solution possible at the expense of some latency which is affected primarily by the speed of the differential data link. The **MATCHEDPOS** log contains the matched RTK solution and can be generated for each processed set of base station observations.

The Low-Latency RTK position is computed from the latest local observations and extrapolated base station observations. This supplies a valid RTK position with the lowest latency possible at the expense of some accuracy. The degradation in accuracy is reflected in the standard deviation and is summarized in [An Introduction to GNSS](#) available on our website. The amount of time that the base station observations are extrapolated is in the "differential age" field of the position log. The Low-Latency RTK system extrapolates for 60 seconds. The **RTKPOS** log (see page 722) contains the Low-Latency RTK position when valid, and an "invalid" status when a Low-Latency RTK solution could not be computed. The **BESTPOS** log (see page 416) contains either the low-latency RTK, PPP or pseudorange-based position, whichever has the smallest standard deviation.

**Message ID: 96**

**Log Type: Asynch**

**Recommended Input:**

```
log matchedposa onchanged
```



**ASCII Example:**

```
#MATCHEDPOSA,COM1,0,63.0,FINESTEERING,1419,340034.000,02000040,2f06,27
24;SOL_COMPUTED,NARROW_INT,51.11635908660,-114.03833102484,1063.8400,-
16.2712,WGS84,0.0140,0.0075,0.0174,"AAAA",0.000,0.000,12,12,12,12,0,01
,0,33*feac3a3a
```



Measurement precision is different from the position computation precision. Measurement precision is a value that shows how accurately the actual code or carrier phase is measured by the GNSS receiver. Position precision is a value that shows the accuracy of the position computation made from the code and/or carrier phase measurements. The P-code L2 measurement precision is not as good as the C/A measurement precision because the NovAtel GNSS receiver is a civilian grade GPS device and does not have direct access to the decrypted military L2 P(Y) code. This means that NovAtel's semi-codeless P-code L2 measurements are noisier than the civilian band C/A code measurements. Refer to the [OEM7 Installation and Operation User Manual](#) for the technical specification of the OEM7 card.

| Field | Field type        | Description  | Format | Binary Bytes | Binary Offset |
|-------|-------------------|--|--------|--------------|---------------|
| 1     | MATCHEDPOS header | Log header. See <i>Messages</i> on page 25 for more information.   |        | H            | 0             |
| 2     | sol status        | Solution status (see <i>Table 73: Solution Status</i> on page 419)   | Enum   | 4            | H             |
| 3     | pos type          | Position type (see <i>Table 74: Position or Velocity Type</i> on page 420)   | Enum   | 4            | H+4           |
| 4     | lat               | Latitude (degrees)   | Double | 8            | H+8           |
| 5     | lon               | Longitude (degrees)  | Double | 8            | H+16          |
| 6     | hgt               | Height above mean sea level (m)  | Double | 8            | H+24          |
| 7     | undulation        | Undulation - the relationship between the geoid and the WGS84 ellipsoid (m)<br><br><div style="border: 1px solid black; padding: 5px; width: fit-content; margin: 10px auto;"> <p>When using a datum other than WGS84, the undulation value also includes the vertical shift due to differences between the datum in use and WGS84.</p> </div> | Float  | 4            | H+32          |
| 8     | datum id#         | Datum ID number (see <i>Table 28: Datum Transformation Parameters</i> on page 116)   | Enum   | 4            | H+36          |
| 9     | lat $\sigma$      | Latitude standard deviation (m)  | Float  | 4            | H+40          |

| Field | Field type                  | Description   | Format  | Binary Bytes | Binary Offset |
|-------|-----------------------------|---|---------|--------------|---------------|
| 10    | lon $\sigma$                | Longitude standard deviation (m)  | Float   | 4            | H+44          |
| 11    | hgt $\sigma$                | Height standard deviation (m)   | Float   | 4            | H+48          |
| 12    | stn id                      | Base station ID   | Char[4] | 4            | H+52          |
| 13    | Reserved                    |   | Float   | 4            | H+56          |
| 14    |                             |   | Float   | 4            | H+60          |
| 15    | #SVs                        | Number of satellites tracked  | Uchar   | 1            | H+64          |
| 16    | #solnSVs                    | Number of satellite vehicles used in solution   | Uchar   | 1            | H+65          |
| 17    | #ggL1                       | Number of satellites with L1/E1/B1 signals used in solution   | Uchar   | 1            | H+66          |
| 18    | #solnMultiSVs               | Number of satellites with multi-frequency signals used in solution  | Uchar   | 1            | H+67          |
| 19    | Reserved                    |   | Hex     | 1            | H+68          |
| 20    | ext sol stat                | Extended solution status (see <i>Table 77: Extended Solution Status</i> on page 423)                        | Hex     | 1            | H+69          |
| 21    | Galileo and BeiDou sig mask | Galileo and BeiDou signals used mask (see <i>Table 76: Galileo and BeiDou Signal-Used Mask</i> on page 423) | Hex     | 1            | H+70          |
| 22    | GPS and GLONASS sig mask    | GPS and GLONASS signals used mask (see <i>Table 75: GPS and GLONASS Signal-Used Mask</i> on page 422)       | Hex     | 1            | H+71          |
| 23    | xxxx                        | 32-bit CRC (ASCII and Binary only)  | Hex     | 4            | H+72          |
| 24    | [CR][LF]                    | Sentence terminator (ASCII only)  | -       | -            | -             |

## 3.82 MATCHEDSATS

### *Satellites used in MATCHEDPOS solution*

**Platform: OEM719, OEM729, OEM7500, OEM7700, OEM7720, PwrPak7, HxGN PIM7500**

This log lists the used and unused satellites for the corresponding MATCHEDPOS solution. It also describes the signals of the used satellites and reasons for exclusions.

**Message ID: 1176**

**Log Type: Asynch**

**Recommended Input:**

```
log matchedsats onchanged
```

**Abbreviated ASCII Example:**

```
<MATCHEDSATS COM1 0 60.5 FINESTEERING 1728 524924.000 02000000 b555
11487
<      24
<      GPS 3 GOOD 00000003
<      GPS 5 GOOD 00000003
...
<      GPS 23 GOOD 00000003
<      GPS 30 GOOD 00000003
<      GLONASS 1+1 GOOD 00000003
<      GLONASS 2-4 GOOD 00000003
...
<      GLONASS 21+4 GOOD 00000003
<      BEIDOU 6 GOOD 00000003
<      BEIDOU 11 GOOD 00000003
...
<      BEIDOU 12 GOOD 00000003
<      BEIDOU 13 GOOD 00000003
```

| Field | Field type         | Description  | Format | Binary Bytes | Binary Offset |
|-------|--------------------|--|--------|--------------|---------------|
| 1     | MATCHEDSATS header | Log header. See <i>Messages</i> on page 25 for more information. |        | H            | 0             |
| 2     | #entries           | Number of records to follow                                      | Ulong  | 4            | H             |
| 3     | system             | See <i>Table 102: Satellite System</i> on page 532               | Enum   | 4            | H+4           |
| 4     | Satellite ID       | Satellite identifier   | Ulong  | 4            | H+8           |

| Field | Field type  | Description   | Format | Binary Bytes | Binary Offset       |
|-------|---|---|--------|--------------|---------------------|
| 5     | Status  | Satellite status ( <i>Table 79: Observation Statuses</i> on page 426)   | Enum   | 4            | H+12                |
| 6     | Signal mask   | See <i>Table 80: BESTSATS GPS Signal Mask</i> on page 427, <i>Table 81: BESTSATS GLONASS Signal Mask</i> on page 428, <i>Table 82: BESTSATS Galileo Signal Mask</i> on page 428, and <i>Table 83: BESTSATS BeiDou Signal Mask</i> on page 428 | Hex    | 4            | H+16                |
| 7     | Next satellite offset = $H + 4 + (\#sat \times 16)$ |   |        |              |                     |
| 8     | xxxx  | 32-bit CRC (ASCII and Binary only)  | Hex    | 1            | H+4+<br>(#sat x 16) |
| 9     | [CR][LF]  | Sentence terminator (ASCII only)  | -      | -            | -                   |

## 3.83 MATCHEDXYZ

### *Matched RTK Cartesian position*

**Platform: OEM719, OEM729, OEM7500, OEM7700, OEM7720, PwrPak7, HxGN PIM7500**

This log contains the receiver's matched position in ECEF coordinates. It represents positions that have been computed from time matched base and rover observations. There is no base station extrapolation error on these positions because they are based on buffered measurements, that is, they lag real time, by some amount, depending on the latency of the data link. If the rover receiver has not been enabled to accept RTK differential data or is not actually receiving data leading to a valid solution, this is reflected by the code shown in field #2 (solution status) and #3 (position type). See *Figure 11: The WGS84 ECEF Coordinate System* on page 437 for a definition of the ECEF coordinates.

This log provides the best accuracy in static operation. For lower latency in kinematic operation, see the **BESTXYZ** log (see page 435) or **RTKXYZ** log (see page 729). The data in the logs changes only when a base observation (RTCMv3) changes.

The time stamp in the header is the time of the matched observations that the computed position is based on and not the current time.

**Message ID: 242**

**Log Type: Asynch**

**Recommended Input:**

```
log matchedxyza onchanged
```



Asynchronous logs, such as MATCHEDXYZ, should only be logged ONCHANGED otherwise the most current data is not output when it is available. This is especially true of the ONTIME trigger, which may cause inaccurate time tags to result.

#### **ASCII Example:**

```
#MATCHEDXYZA,COM1,0,62.5,FINESTEERING,1419,340035.000,02000040,b8ed,27
24;SOL_COMPUTED,NARROW_INT,-1634531.5703,-
3664618.0321,4942496.3280,0.0080,0.0159,0.0154,"AAAA",12,12,12,12,0,01
,0,33*e4b84015
```

| Field | Field type        | Description   | Format | Binary Bytes | Binary Offset |
|-------|-------------------|---|--------|--------------|---------------|
| 1     | MATCHEDXYZ header | Log header. See <i>Messages</i> on page 25 for more information.  |        | H            | 0             |
| 2     | P-sol status      | Solution status, see <i>Table 73: Solution Status</i> on page 419 | Enum   | 4            | H             |

| Field | Field type                  | Description   | Format  | Binary Bytes | Binary Offset |
|-------|-----------------------------|---|---------|--------------|---------------|
| 3     | pos type                    | Position type, see <i>Table 74: Position or Velocity Type</i> on page 420                                   | Enum    | 4            | H+4           |
| 4     | P-X                         | Position X-coordinate (m)   | Double  | 8            | H+8           |
| 5     | P-Y                         | Position Y-coordinate (m)   | Double  | 8            | H+16          |
| 6     | P-Z                         | Position Z-coordinate (m)   | Double  | 8            | H+24          |
| 7     | P-X $\sigma$                | Standard deviation of P-X (m)   | Float   | 4            | H+32          |
| 8     | P-Y $\sigma$                | Standard deviation of P-Y (m)   | Float   | 4            | H+36          |
| 9     | P-Z $\sigma$                | Standard deviation of P-Z (m)   | Float   | 4            | H+40          |
| 10    | stn ID                      | Base station ID   | Char[4] | 4            | H+44          |
| 11    | #SVs                        | Number of satellites tracked  | Uchar   | 1            | H+48          |
| 12    | #solnSVs                    | Number of satellite vehicles used in solution   | Uchar   | 1            | H+49          |
| 13    | #ggL1                       | Number of satellites with L1/E1/B1 signals used in solution   | Uchar   | 1            | H+50          |
| 14    | #solnMultiSVs               | Number of satellites with multi-frequency signals used in solution  | Uchar   | 1            | H+51          |
| 15    | Reserved                    |   | Char    | 1            | H+52          |
| 16    | ext sol stat                | Extended solution status (see <i>Table 77: Extended Solution Status</i> on page 423)                        | Hex     | 1            | H+53          |
| 17    | Galileo and BeiDou sig mask | Galileo and BeiDou signals used mask (see <i>Table 76: Galileo and BeiDou Signal-Used Mask</i> on page 423) | Hex     | 1            | H+54          |
| 18    | GPS and GLONASS sig mask    | GPS and GLONASS signals used mask (see <i>Table 75: GPS and GLONASS Signal-Used Mask</i> on page 422)       | Hex     | 1            | H+55          |
| 19    | xxxx                        | 32-bit CRC (ASCII and Binary only)  | Hex     | 4            | H+56          |
| 20    | [CR][LF]                    | Sentence terminator (ASCII only)  | -       | -            | -             |

## 3.84 MODELFEATURES

### *States features available for current loaded model*

**Platform: OEM719, OEM729, OEM7500, OEM7700, OEM7720, PwrPak7, HxGN PIM7500**

The MODELFEATURES log states the features available for the current loaded model.

To see which satellite systems are available for the current model, use the **CHANCONFIGLIST** log (see page 440).

Most features have a boolean state: authorized or unauthorized. However, some have more complex licensed states with varying degrees of capability.



This log is best viewed in Abbreviated ASCII.

**Message ID: 1329**

**Log Type: Polled**

**Recommended Input:**

```
log modelfeatures once
```

**Abbreviated ASCII Example:**

```
[COM1]<MODELFEATURES COM1 0 78.0 FINESTEERING 1966 230967.288 02000020
141a 32768
< 25
< 20HZ MAX_MSR_RATE
< 20HZ MAX_POS_RATE
< SINGLE ANTENNA
< NAVIGATION IMU
< STANDARD INS
< AUTHORIZED MEAS_OUTPUT
< AUTHORIZED DGPS_TX
< AUTHORIZED RTK_TX
< AUTHORIZED RTK_FLOAT
< AUTHORIZED RTK_FIXED
< AUTHORIZED PPP
< AUTHORIZED LOW_END_POSITIONING
< AUTHORIZED RAIM
< AUTHORIZED NTRIP
< AUTHORIZED GENERIC_IMU
< AUTHORIZED DEBUG
< UNAUTHORIZED ALIGN_HEADING
< UNAUTHORIZED ALIGN_RELATIVE_POS
< UNAUTHORIZED API
< UNAUTHORIZED INTERFERENCE_MITIGATION
< UNAUTHORIZED RTKASSIST
< UNAUTHORIZED SCINTILLATION
< UNAUTHORIZED INS_PLUS_PROFILES
< UNAUTHORIZED HEAVE
```

```
<          UNAUTHORIZED_RELATIVE_INS
```

```
[COM1]<MODELFEATURES COM1 0 74.0 FINESTEERING 1875 508886.133 02000000
141a 32768
```

```
<    18
<      20HZ_MAX_MSR_RATE
<      20HZ_MAX_POS_RATE
<      IMU_LOW_QUALITY_MEMS IMU
<      INS_HEAVE INS
<      AUTHORIZED_MEAS_OUTPUT
<      AUTHORIZED_DGPS_TX
<      AUTHORIZED_RTK_TX
<      AUTHORIZED_RTK_FLOAT
<      AUTHORIZED_RTK_FIXED
<      AUTHORIZED_PPP
<      AUTHORIZED_LOW_END_POSITIONING
<      AUTHORIZED_RAIM
<      AUTHORIZED_ALIGN_HEADING
<      AUTHORIZED_ALIGN_RELATIVE_POS
<      AUTHORIZED_NTRIP
<      UNAUTHORIZED_API
<      UNAUTHORIZED_SCINTILLATION
```

| Field | Field type                         | Description  | Format | Binary Bytes | Binary Offset       |
|-------|------------------------------------|--|--------|--------------|---------------------|
| 1     | MODELFEATURES header               | Log header. See <i>Messages</i> on page 25 for more information.                     | -      | H            | 0                   |
| 2     | # Feature                          | Number of features in list   | Ulong  | 4            | H                   |
| 3     | Feature Status                     | Licensing status of feature<br>See <i>Table 110: Feature Status</i> on the next page | Enum   | 4            | H+4                 |
| 4     | Feature Type                       | Type of feature<br>See <i>Table 111: Feature</i> on the next page                    | Enum   | 4            | H+8                 |
| 5...  | Next feature = H+4+(# Feature x 8) |  |        |              |                     |
| 6     | xxxx                               | 32-bit CRC (ASCII and Binary only)   | Ulong  | 4            | H+4+(# Feature x 8) |
| 7     | [CR][LF]                           | Sentence terminator (ASCII only)   | -      | -            | -                   |



**Table 110: Feature Status**

| Value | Name                | Description  |
|-------|---------------------|--|
| 0     | AUTHORIZED          | The feature is authorized                          |
| 1     | UNAUTHORIZED        | The feature is unauthorized                        |
| 2     | 0Hz                 | Disables output of POS logs                        |
| 3     | Reserved            |  |
| 4     | Reserved            |  |
| 5     | Reserved            |  |
| 6     | 20Hz                | Maximum logging rate for POS or MSR logs is 20 Hz  |
| 7     | Reserved            |  |
| 8     | 100Hz               | Maximum logging rate for POS or MSR logs is 100 Hz |
| 9     | RATE_INVALID        | Option bits don't correspond to a valid rate       |
| 15    | STANDARD            | SPAN Standard Model                                |
| 20    | LOW_QUALITY_MEMS    | IMU Grade-Low Quality MEMS                         |
| 21    | LOW_GRADE_TACTICAL  | IMU Grade-Low Grade Tactical                       |
| 22    | HIGH_GRADE_TACTICAL | IMU Grade-High Grade Tactical                      |
| 23    | NAVIGATION          | IMU Grade-Navigation                               |
| 25    | SINGLE              | Single antenna                                     |
| 26    | DUAL                | Dual antenna                                       |
| 30    | LITE                | SPAN Lite Model                                    |
| 33    | COMMERCIAL_MEMS     | IMU Grade-Commercial Grade MEMS                    |

**Table 111: Feature**

| Value | Name         | Description  |
|-------|--------------|--|
| 0     | MAX_MSR_RATE | Maximum measurement logging rate                   |
| 1     | MAX_POS_RATE | Maximum position logging rate                      |
| 3     | MEAS_OUTPUT  | Output of raw measurements (phase and pseudorange) |
| 4     | DGPS_TX      | Transmission of DGPS (non RTK) corrections         |
| 5     | RTK_TX       | Transmission of RTK corrections                    |
| 6     | RTK_FLOAT    | RTK float positioning                              |

| <b>Value</b> | <b>Name</b>                     | <b>Description</b>   |
|--------------|---------------------------------|--|
| 7            | RTK_FIXED                       | RTK fixed positioning  |
| 8            | RAIM                            | Extended RAIM  |
| 9            | LOW_END_POSITIONING             | GLIDE and TerraStar-L positioning  |
| 10           | ALIGN_HEADING                   | Heading  |
| 11           | ALIGN_RELATIVE_POS              | Heading and Relative Positioning   |
| 12           | API                             | Lua Scripted User Interface (formerly User Application API)                                  |
| 15           | NTRIP                           | NTRIP Server/Client  |
| 19           | PPP                             | TerraStar-C positioning  |
| 20           | SCINTILLATION                   | Scintillation  |
| 22           | INS                             | Inertial (SPAN)  |
| 23           | IMU                             | IMU Grade  |
| 26           | FEATURE_INTERFERENCE_MITIGATION | Interference Mitigation  |
| 28           | ANTENNA                         | Number of antenna enabled on the receiver  |
| 29           | GENERIC_IMU                     | SPAN Generic IMU Interface   |
| 30           | INS_PLUS_PROFILES               | SPAN Plus Profiles   |
| 31           | HEAVE                           | SPAN Heave Option  |
| 32           | RELATIVE_INS                    | SPAN Relative INS  |
| 999          | MODEL_INVALID                   | If a bad model is loaded, MODELFEATURES will contain one entry: MODEL_INVALID STATUS_INVALID |

## 3.85 NAVICALMANAC

### *Decoded NavIC Almanac*

**Platform: OEM719, OEM729, OEM7500, OEM7700, OEM7720, PwrPak7, HxGN PIM7500**

This log contains the decoded NavIC almanac parameters from NavIC navigation messages. Multiple messages are transmitted, one for each satellite ID with data.

The OEM7 family of receivers automatically save almanacs in their Non-Volatile Memory (NVM), so creating an almanac boot file is not necessary.

**Message ID: 2122**

**Log Type: Asynch**

**Recommended Input:**

```
log navicalmanaca onchanged
```

**ASCII Example:**

```
#NAVICALMANACA, COM1, 4, 69.5, SATTIME, 1943, 158160.000, 02000020, fb6e, 32768
; 919, 0.001982212, 86400, 0.075264303, 8.457495146e-10, 6493.383789062,
1.327344662, 2.996060720, 2.542881375, -0.000580788, 7.275957614e-12,
6, 0, 0, 5*05cfbc62
```

```
#NAVICALMANACA, COM1, 3, 69.5, SATTIME, 1943, 156276.000, 02000020, fb6e, 32768
; 919, 0.001962662, 0, 0.509411950, 2.742971399e-10, 6493.538574219,
1.844826864, 3.107479183, -3.001633760, -0.000161171, -5.093170330e-11,
4, 0, 0, 7*8fbd9e3a
```

```
#NAVICALMANACA, COM1, 2, 69.5, SATTIME, 1943, 158148.000, 02000020, fb6e, 32768
; 919, 0.001979351, 86400, 0.499982612, 2.400099974e-10, 6493.359375000,
-1.300198895, -3.061969089, 0.047002130, 0.000025749, -3.637978807e-12,
5, 0, 0, 5*be12ffa2
```

```
#NAVICALMANACA, COM1, 1, 69.5, SATTIME, 1943, 157620.000, 02000020, fb6e, 32768
; 919, 0.001854897, 86400, 0.509561753, 1.371485699e-10, 6493.388671875,
1.842267109, 3.032190537, 2.385950946, 0.000114441, -5.456968211e-11,
2, 0, 0, 5*b64cf69c
```

```
#NAVICALMANACA, COM1, 0, 69.5, SATTIME, 1943, 156804.000, 02000020, fb6e, 32768
; 919, 0.000161171, 86400, 0.076541746, 1.142904749e-09, 6493.613281250,
1.349937548, 0.783248119, 0.142653098, 0.000204086, -8.003553376e-11,
7, 0, 0, 7*495808b9
```



The speed at which the receiver locates and locks onto new satellites is improved if the receiver has approximate time and position, as well as an almanac. This allows the receiver to compute the elevation of each satellite so it can tell which satellites are visible and their Doppler offsets, improving Time to First Fix (TTFF).

| Field | Field Type          | Description  | Format | Binary Bytes | Binary Offset |
|-------|---------------------|--|--------|--------------|---------------|
| 1     | NAVICALMANAC header | Log header. See <i>Messages</i> on page 25 for more information.                       | -      | H            | 0             |
| 2     | WNa                 | Week number for the almanac since the IRNSS system time start epoch (August 22nd 1999) | Ulong  | 4            | H             |
| 3     | Ecc                 | Eccentricity (dimensionless)   | Double | 8            | H+4           |
| 4     | Toa                 | Time of Almanac (sec)  | Ulong  | 4            | H+12          |
| 5     | I0                  | Inclination angel (radians)  | Double | 8            | H+16          |
| 6     | OmegaDot            | Rate of RAAN (radians/sec)   | Double | 8            | H+24          |
| 7     | RootA               | Square root of semi-major axis(sqrt (metres))  | Double | 8            | H+32          |
| 8     | Omega0              | Longitude of ascending node (LAN) (radians)  | Double | 8            | H+40          |
| 9     | Omega               | Argument of perigee (radians)  | Double | 8            | H+48          |
| 10    | M0                  | Mean Anomaly (radians)   | Double | 8            | H+56          |
| 11    | Af0                 | Clock bias A0 (sec)  | Double | 8            | H+64          |
| 12    | Af1                 | Clock Drift A1 (sec/sec)   | Double | 8            | H+72          |
| 13    | AlmSVID             | PRN ID for Almanac   | Ulong  | 4            | H+80          |
| 14    | InterSigCorr        | Inter Signal Correction (sec)  | Ulong  | 4            | H+84          |
| 15    | Spare               |  | Ulong  | 4            | H+88          |
| 16    | PRN                 | Satellite Identifier   | Ulong  | 4            | H+92          |
| 17    | xxxx                | 32-bit CRC (ASCII and Binary only)   | Hex    | 4            | H+96          |
| 18    | [CR][LF]            | Sentence terminator (ASCII only)   | -      | -            | -             |

## 3.86 NAVICEPHEMERIS

### *Decoded NavIC Ephemeris*

**Platform: OEM719, OEM729, OEM7500, OEM7700, OEM7720, PwrPak7, HxGN PIM7500**

This log contains NavIC ephemeris parameters with the appropriate scaling applied. Multiple messages are transmitted, one for each SV ephemeris collected.

**Message ID: 2123**

**Log Type: Asynch**

**Recommended Input:**

```
log navicephemerisa onchanged
```

**ASCII Example:**

```
#NAVICEPHEMERISA,COM1,5,74.0,SATTIME,1943,255984.000,02000020,01fa,
32768;2,919,1.05838757e-04,-5.63886715e-11,0.00000000,0,252000,
-1.86e-09,3.2829938927e-09,11,0,0,0,1.922249794e-06,1.032650471e-05,
2.011656761e-07,4.097819328e-08,-230.9375000,66.1250000,
-5.239503961e-10,0,1.900019163,252000,1.8492219970e-03,6493.385761,
1.842761896e+00,3.027013584,-2.94012247e-09,5.0965660552e-01,0,0,0
*d2f4c9a5
```

```
#NAVICEPHEMERISA,COM1,4,74.0,SATTIME,1943,255984.000,02000020,01fa,
32768;6,919,-5.79587650e-04,1.02318154e-11,0.00000000,1,252000,
-1.86e-09,8.5817860373e-09,11,0,0,0,-1.282989979e-05,2.417713404e-06,
1.974403858e-07,2.644956112e-07,-83.3125000,-395.3125000,
-5.535944880e-10,0,2.050709297,252000,1.9699299010e-03,6493.408867,
1.328589850e+00,2.996532035,-7.66746224e-09,7.5298187077e-02,0,0,0
*50cdb388
```

...

```
#NAVICEPHEMERISA,COM1,0,74.0,SATTIME,1943,255984.000,02000020,01fa,
32768;7,919,1.90386083e-04,-8.28777047e-11,0.00000000,1,255024,
-1.40e-09,6.3988379659e-09,252,0,0,0,-8.992850780e-06,
-1.732259989e-06,-9.313225746e-08,-2.235174179e-08,60.1250000,
-266.1875000,-3.928735076e-10,0,-0.445949980,255024,2.4348858278e-04,
6493.269802,1.351327715e+00,1.099632488,-5.54308803e-09,
7.6573741924e-02,0,0,0*01bf330e
```

| Field | Field Type            | Description  | Format | Binary Bytes | Binary Offset |
|-------|-----------------------|--|--------|--------------|---------------|
| 1     | NAVICEPHEMERIS header | Log header. See <i>Messages</i> on page 25 for more information. | -      | H            | 0             |
| 2     | PRN                   | Satellite Identifier (1 to 7)                                    | Ulong  | 4            | H             |

| Field | Field Type | Description  | Format | Binary Bytes | Binary Offset |
|-------|------------|--|--------|--------------|---------------|
| 3     | WN         | Week number since the IRNSS system time start epoch (August 22nd 1999)                 | Ulong  | 4            | H+4           |
| 4     | Af0        | Clock bias (sec)   | Double | 8            | H+8           |
| 5     | Af1        | Clock drift (sec/sec)  | Double | 8            | H+16          |
| 6     | Af2        | Clock drift rate (sec/sec <sup>2</sup> )   | Double | 8            | H+24          |
| 7     | URA        | SV Accuracy  | Ulong  | 4            | H+32          |
| 8     | toc        | Reference time for the satellite clock corrections (sec)                               | Ulong  | 4            | H+36          |
| 9     | TGD        | Total group delay (sec)  | Double | 8            | H+40          |
| 10    | DeltaN     | Mean motion difference (radian/sec)  | Double | 8            | H+48          |
| 11    | IODEC      | Issue of data ephemeris and clock  | Ulong  | 4            | H+56          |
| 12    | Reserved   |  | Ulong  | 4            | H+60          |
| 13    | L5 Health  | Health status of navigation data on L5 SPS signal<br>0=OK; 1=bad                       | Ulong  | 4            | H+64          |
| 14    | S Health   | Health status of navigation data on S SPS signal<br>0=OK; 1=bad                        | Ulong  | 4            | H+68          |
| 15    | Cuc        | Amplitude of the cosine harmonic correction term to the argument of latitude (radians) | Double | 8            | H+72          |
| 16    | Cus        | Amplitude of the sine harmonic correction term to the argument of latitude (radians)   | Double | 8            | H+80          |
| 17    | Cic        | Amplitude of the cosine harmonic correction term to the angle of inclination (radians) | Double | 8            | H+88          |
| 18    | Cis        | Amplitude of the sine harmonic correction term to the angle of inclination (radians)   | Double | 8            | H+96          |
| 19    | Crc        | Amplitude of the cosine harmonic correction term to the orbit radius (metres)          | Double | 8            | H+104         |

| Field | Field Type   | Description  | Format | Binary Bytes | Binary Offset |
|-------|--------------|--|--------|--------------|---------------|
| 20    | Crs          | Amplitude of the sine harmonic correction term to the orbit radius (metres)  | Double | 8            | H+112         |
| 21    | IDOT         | Rate of inclination angle (radians/sec)  | Double | 8            | H+120         |
| 22    | Spare        |  | Ulong  | 4            | H+128         |
| 23    | M0           | Mean anomaly (radians)   | Double | 8            | H+132         |
| 24    | toe          | Time of ephemeris (sec)  | Ulong  | 4            | H+140         |
| 25    | Ecc          | Eccentricity (dimensionless)   | Double | 8            | H+144         |
| 26    | RootA        | Square root of semi-major axis (sqrt (metres))   | Double | 8            | H+152         |
| 27    | Omega0       | Longitude of ascending node (radians)  | Double | 8            | H+160         |
| 28    | Omega        | Argument of perigee (radians)  | Double | 8            | H+168         |
| 29    | OmegaDot     | Rate of RAAN (radians/sec)   | Double | 8            | H+176         |
| 30    | I0           | Inclination angle (radians)  | Double | 8            | H+184         |
| 31    | Spare        |  | Ulong  | 4            | H+192         |
| 32    | Alert flag   | The utilization of navigation data shall be at the users' own risk.<br>1=Alert; 0=OK )   | Ulong  | 4            | H+196         |
| 33    | AutoNav flag | When set to 1, satellite is in AutoNav mode.<br>Satellite broadcasts primary navigation parameters from AutoNav data sets with no uplink from ground for maximum of 7 days | Ulong  | 4            | H+200         |
| 34    | xxxx         | 32-bit CRC (ASCII and Binary only)   | Hex    | 4            | H+204         |
| 35    | [CR][LF]     | Sentence terminator (ASCII only)   | -      | -            | -             |

## 3.87 NAVICIONO

### *NavIC ionospheric coefficients parameters*

**Platform: OEM719, OEM729, OEM7500, OEM7700, OEM7720, PwrPak7, HxGN PIM7500**

This log contains NavIC ionospheric coefficients parameters. Ionospheric error correction for single frequency (L5) users of the NavIC are provided through a set of eight coefficients. The correction coefficients are:

- 4 Alpha Coefficients ( $\alpha_n$ ;  $n=0,1,2,3$ )

These are the coefficients of the cubic polynomial representing the amplitude of the positive cosine curve in the cosine model approximation of ionospheric delay.

- 4 Beta Coefficients ( $\beta_n$ ;  $n=0,1,2,3$ )

These are the coefficients of the cubic polynomial representing the period of the positive cosine curve in the cosine model approximation of ionospheric delay.

**Message ID: 2124**

**Log Type: Asynch**

**Recommended Input:**

```
log navicionoa onchanged
```

**ASCII Example:**

```
#NAVICIONOA,COM1,0,92.5,SATTIME,1944,166272.000,02000020,56c0,32768;
5,2.980232238769531e-08,3.874301910400390e-07,-2.562999725341796e-06,
-7.510185241699216e-06,558.0,168.0,-2286.0,2286.0,0*2b250bbd
```

| Field | Field Type       | Description  | Format | Binary Bytes | Binary Offset |
|-------|------------------|--|--------|--------------|---------------|
| 1     | NAVICIONO header | Log header. See <i>Messages</i> on page 25 for more information.                                       | -      | H            | 0             |
| 2     | PRN              | Satellite Identifier of the transmitting NavIC SV (from 1 to 7)  | Ulong  | 4            | H             |
| 3     | Alpha 0          | Coefficient of the amplitude of the vertical delay constant term (sec)                                 | Double | 8            | H+4           |
| 4     | Alpha 1          | Coefficient of the amplitude of the vertical delay first-order term (sec/semi-circle)                  | Double | 8            | H+12          |
| 5     | Alpha 2          | Coefficient of the amplitude of the vertical delay second-order term (sec/(semi-circle) <sup>2</sup> ) | Double | 8            | H+20          |
| 6     | Alpha 3          | Coefficient of the amplitude of the vertical delay third-order term (sec/(semi-circle) <sup>3</sup> )  | Double | 8            | H+28          |



| Field | Field Type | Description  | Format | Binary Bytes | Binary Offset |
|-------|------------|--|--------|--------------|---------------|
| 7     | Beta 0     | The coefficient of a cubic equation representing the period of the model constant term (sec)                                 | Double | 8            | H+36          |
| 8     | Beta 1     | The coefficient of a cubic equation representing the period of the model first-order term (sec/semi-circle)                  | Double | 8            | H+44          |
| 9     | Beta 2     | The coefficient of a cubic equation representing the period of the model second-order term (sec/(semi-circle) <sup>2</sup> ) | Double | 8            | H+52          |
| 10    | Beta 3     | The coefficient of a cubic equation representing the period of the model third-order term (sec/(semi-circle) <sup>3</sup> )  | Double | 8            | H+60          |
| 11    | Spare      |  | Ulong  | 4            | H+68          |
| 12    | xxxx       | 32-bit CRC (ASCII and Binary only)   | Hex    | 4            | H+72          |
| 13    | [CR][LF]   | Sentence terminator (ASCII only)   | -      | -            | -             |

## 3.88 NAVICRAWSUBFRAME

### *Raw NavIC subframe data*

**Platform: OEM719, OEM729, OEM7500, OEM7700, OEM7720, PwrPak7, HxGN PIM7500**

This log contains the raw NavIC subframe data with parity bits removed. Only subframes that have passed the parity check are output.

**Message ID: 2105**

**Log Type: Asynch**

**Recommended Input:**

```
log navicrawsubframea onchanged
```

**ASCII Example:**

```
#NAVICRAWSUBFRAMEA,COM1,0,72.5,SATTIME,1943,159168.000,02000020,76af,3
2768;182,7,1,8b19e883971a005bf4880009ab3f400eac0af84f7541befff78018e6d
7e1dfacd1*88c2ba19
```

```
#NAVICRAWSUBFRAMEA,COM1,0,72.5,SATTIME,1943,159168.000,02000020,76af,3
2768;177,2,1,8b19e883970e8fc3f8500009ab3f00087f0af8415e4232800f7fd9eb8
650b7b630*c7e27e82
```

```
#NAVICRAWSUBFRAMEA,COM1,0,72.5,SATTIME,1943,159168.000,02000020,76af,3
2768;181,6,1,8b19e88397b3e73401600009ab3f0012370af84f550327c032800ad1d
9da339260*0bb7b256
```

```
#NAVICRAWSUBFRAMEA,COM1,0,72.5,SATTIME,1943,159168.000,02000020,76af,3
2768;180,5,1,8b19e88397036703ff1c0049ab3fc009b10af84fe7e3773ffd7fd6d8f
5fddc4181*f42f59ab
```

| Field | Field Type              | Description  | Format  | Binary Bytes | Binary Offset |
|-------|-------------------------|--|---------|--------------|---------------|
| 1     | NAVICRAWSUBFRAME header | Log header. See <i>Messages</i> on page 25 for more information.   | -       | H            | 0             |
| 2     | SigChan Number          | Signal channel providing the data                                  | Ulong   | 4            | H             |
| 3     | PRN                     | Satellite Identifier of transmitting NavIC SV (from 1 to 7)        | Ulong   | 4            | H+4           |
| 4     | Subframe Id             | Subframe ID  | Ulong   | 4            | H+8           |
| 5     | Raw Subframe Data       | Raw subframe data (262 bits).<br>Does not include CRC or Tail bits | Hex[33] | 33           | H+12          |
| 6     | xxxx                    | 32-bit CRC (ASCII and Binary only)                                 | Hex     | 4            | H+45          |
| 7     | [CR][LF]                | Sentence terminator (ASCII only)                                   | -       | -            | -             |

## 3.89 NAVICSYSCLOCK

### *NavIC clock parameters*

**Platform: OEM719, OEM729, OEM7500, OEM7700, OEM7720, PwrPak7, HxGN PIM7500**

This log provides the NavIC system time offset with respect to UTC, UTC (NPLI) and other GNSS times such as GPS, GALILEO, GLONASS.

**Message ID: 2125**

**Log Type: Asynch**

**Recommended Input:**

```
log navicsysclocka onchanged
```

**ASCII Example:**

```
#NAVICSYSCLOCKA,COM1,0,93.0,SATTIME,1944,166320.000,02000020,3dfd,
32768;7,-7.625203579664230e-09,-1.598721155460225e-14,
0.0000000000000000e+00,18,32508,920,905,7,18,2,2.149608917534351e-07,
-5.151434834260726e-14,-1.998997755520149e-19,32508,920,0*f6617e67
```

| Field | Field Type             | Description   | Format | Binary Bytes | Binary Offset |
|-------|------------------------|---|--------|--------------|---------------|
| 1     | NAVICSYSCLOCK header   | Log header. See <i>Messages</i> on page 25 for more information.                                      |        | H            | 0             |
| 2     | PRN                    | Satellite Identifier of the transmitting NavIC SV (from 1 to 7)                                       | Ulong  | 4            | H             |
| 3     | $A0_{\text{utc}}$      | Bias coefficient of the NavIC time scale relative to the UTC time scale (sec)                         | Double | 8            | H+4           |
| 4     | $A1_{\text{utc}}$      | Drift coefficient of the NavIC time scale relative to the UTC time scale (sec/sec)                    | Double | 8            | H+12          |
| 5     | $A2_{\text{utc}}$      | Drift rate coefficient of the NavIC time scale relative to the UTC time scale (sec/sec <sup>2</sup> ) | Double | 8            | H+20          |
| 6     | $\Delta t_{\text{LS}}$ | Current or past leap second count (sec)   | Long   | 4            | H+28          |
| 7     | $T_{\text{outc}}$      | Time data reference time of week (sec)  | Ulong  | 4            | H+32          |
| 8     | $WN_{\text{outc}}$     | Time data reference week number (week)  | Ulong  | 4            | H+36          |
| 9     | $WN_{\text{LSF}}$      | Leap second reference week number (week)  | Ulong  | 4            | H+40          |
| 10    | DN                     | Leap second reference day number (days)   | Ulong  | 4            | H+44          |

| Field | Field Type       | Description   | Format | Binary Bytes | Binary Offset |
|-------|------------------|---|--------|--------------|---------------|
| 11    | $\Delta t_{LSF}$ | Current or future leap second count (sec)   | Long   | 4            | H+48          |
| 12    | GNSSID           | Timescale for the time offsets with respect to NavIC ( <i>Table 112: GNSS Time Scales</i> below)                  | Ulong  | 4            | H+52          |
| 13    | A0               | Bias coefficient of the NavIC time scale relative to the GNSS time scale (sec)                                    | Double | 8            | H+56          |
| 14    | A1               | Drift coefficient of the NavIC time scale relative to the GNSS time scale (sec/sec)                               | Double | 8            | H+64          |
| 15    | A2               | Drift rate correction coefficient of the NavIC time scale relative to the GNSS time scale (sec/sec <sup>2</sup> ) | Double | 8            | H+72          |
| 16    | Tot              | Time data reference time of week (sec)  | Ulong  | 4            | H+80          |
| 17    | WNot             | Time data reference week number (week)  | Ulong  | 4            | H+84          |
| 18    | Spare            |   | Ulong  | 4            | H+88          |
| 19    | xxxx             | 32-bit CRC (ASCII and Binary only)  | Hex    | 4            | H+92          |
| 20    | [CR][LF]         | Sentence terminator (ASCII only)  | -      | -            | -             |

**Table 112: GNSS Time Scales**

| GNSS ID | Time Scale |
|---------|------------|
| 0       | GPS        |
| 1       | GALILEO    |
| 2       | GLONASS    |
| 3-6     | Reserved   |
| 7       | UTC (NPLI) |

## 3.90 NAVIGATE

### *User navigation data*

**Platform: OEM719, OEM729, OEM7500, OEM7700, OEM7720, PwrPak7, HxGN PIM7500**

This log reports the status of the waypoint navigation progress. It is used in conjunction with the **SETNAV** command (see page 341).

See the figure below for an illustration of navigation parameters.



The **SETNAV** command (see page 341) must be enabled before valid data will be reported from this log.

**Figure 12: Navigation Parameters**

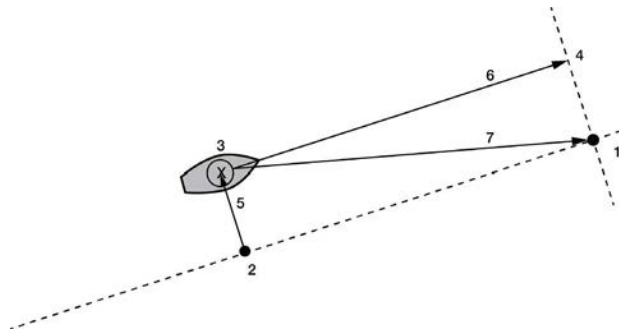

| Reference | Description                           |
|-----------|---------------------------------------|
| 1         | TO lat-lon                            |
| 2         | X-Track perpendicular reference point |
| 3         | Current GPS position                  |
| 4         | A-Track perpendicular reference point |
| 5         | X-Track (cross track)                 |
| 6         | A-Track (along track)                 |
| 7         | Distance and bearing from 3 to 1      |

**Message ID: 161**

**Log Type: Sync**

**Recommended Input:**

```
log navigatea ontime 1
```

**ASCII Example:**

```
#NAVIGATEA,COM1,0,56.0,FINESTEERING,1337,399190.000,02000000,aece,1984
;SOL_COMPUTED,PSRDIFF,SOL_
COMPUTED,GOOD,9453.6278,303.066741,133.7313,9577.9118,1338,349427.562*
643cd4e2
```



Use the NAVIGATE log in conjunction with the **SETNAV** command (see page 341) to tell you where you currently are with relation to known To and From points. You can find a specific latitude, longitude or height knowing from where you started. For example, a backpacker could use these two commands to program a user supplied graphical display, on a digital GPS compass, to show their progress as they follow a defined route.

| Field | Field Type      | Description  | Format | Binary Bytes | Binary Offset |
|-------|-----------------|--|--------|--------------|---------------|
| 1     | NAVIGATE header | Log header. See <i>Messages</i> on page 25 for more information.   |        | H            | 0             |
| 2     | sol status      | Solution status, see <i>Table 73: Solution Status</i> on page 419  | Enum   | 4            | H             |
| 3     | pos type        | Position type, see <i>Table 74: Position or Velocity Type</i> on page 420  | Enum   | 4            | H+4           |
| 4     | vel status      | Velocity status, see <i>Table 73: Solution Status</i> on page 419  | Enum   | 4            | H+8           |
| 5     | nav type        | Navigation data type (see <i>Table 113: Navigation Data Type</i> on the next page)   | Enum   | 4            | H+12          |
| 6     | distance        | Straight line horizontal distance from current position to the destination waypoint, in metres (see <i>Figure 12: Navigation Parameters</i> on the previous page). This value is positive when approaching the waypoint and becomes negative on passing the waypoint | Double | 8            | H+16          |
| 7     | bearing         | Direction from the current position to the destination waypoint, in degrees, with respect to True North (or magnetic if corrected for magnetic variation by the <b>MAGVAR</b> command on page 225)   | Double | 8            | H+24          |
| 8     | along track     | Horizontal track distance from the current position to the closest point on the waypoint arrival perpendicular; expressed in metres. This value is positive when approaching the waypoint and becomes negative on passing the waypoint                               | Double | 8            | H+32          |

| Field | Field Type | Description  | Format | Binary Bytes | Binary Offset |
|-------|------------|--|--------|--------------|---------------|
| 9     | xtrack     | The horizontal distance (perpendicular track error), from the vessel's present position to the closest point on the great circle line, that joins the FROM and TO waypoints. If a "track offset" has been entered in the <b>SETNAV</b> command (see page 341), xtrack is the perpendicular error from the "offset track". Xtrack is expressed in metres. Positive values indicate the current position is right of the Track, while negative offset values indicate left | Double | 8            | H+40          |
| 10    | eta week   | Estimated GPS reference week number at time of arrival at the "TO" waypoint, along track arrival perpendicular based on current position and speed, in units of GPS reference weeks. If the receiving antenna is moving at a speed of less than 0.1 m/s, in the direction of the destination, the value in this field is "9999"  | Ulong  | 4            | H+48          |
| 11    | eta secs   | Estimated GPS seconds into week at time of arrival at destination waypoint along track arrival perpendicular, based on current position and speed, in units of GPS seconds into the week. If the receiving antenna is moving at a speed of less than 0.1 m/s in the direction of the destination, the value in this field is "0.000"   | Double | 8            | H+52          |
| 12    | xxxx       | 32-bit CRC (ASCII and Binary only)   | Ulong  | 4            | H+60          |
| 13    | [CR][LF]   | Sentence terminator (ASCII only)   | -      | -            | -             |

**Table 113: Navigation Data Type**

| Binary | ASCII            | Description   |
|--------|------------------|---|
| 0      | GOOD             | Navigation is good                                  |
| 1      | NOVELOCITY       | Navigation has no velocity                          |
| 2      | BADNAV           | Navigation calculation failed for an unknown reason |
| 3      | FROM_TO_SAME     | "From" is too close to "To" for computation         |
| 4      | TOO_CLOSE_TO_TO  | Position is too close to "To" for computation       |
| 5      | ANTIPODAL_WAYPTS | Waypoints are antipodal on surface                  |

## 3.91 NMEA Standard Logs

**Platform: OEM719, OEM729, OEM7500, OEM7700, OEM7720, PwrPak7, HxGN PIM7500**

This log contains NMEA logs.

|                  |   |
|------------------|---|
| <b>GLMLA</b>     | <b>GLONASS Almanac Data</b>                           |
| <b>GPALM</b>     | <b>Almanac Data</b>                                   |
| <b>GPGGA</b>     | <b>Global Position System Fix Data and Undulation</b> |
| <b>GPGGALONG</b> | <b>GPS Fix Data, Extra Precision and Undulation</b>   |
| <b>GPGLL</b>     | <b>Geographic Position</b>                            |
| <b>GPGRS</b>     | <b>GPS Range Residuals for Each Satellite</b>         |
| <b>GPGSA</b>     | <b>GPS DOP on Active Satellites</b>                   |
| <b>GPGST</b>     | <b>Pseudorange Measurement Noise Statistics</b>       |
| <b>GPGSV</b>     | <b>GPS Satellites in View</b>                         |
| <b>GPHDT</b>     | <b>NMEA Heading Log (ALIGN)</b>                       |
| <b>GPRMB</b>     | <b>Navigation Information</b>                         |
| <b>GPRMC</b>     | <b>GPS Specific Information</b>                       |
| <b>GPVTG</b>     | <b>Track Made Good and Ground Speed</b>               |
| <b>GPZDA</b>     | <b>UTC Time and Date</b>                              |

The NMEA log structures follow format standards as adopted by the National Marine Electronics Association. The reference document used is "Standard For Interfacing Marine Electronic Devices NMEA 0183 Version 3.01". For further information, refer to the [Standards and References](#) section of our website [www.novatel.com/support/](http://www.novatel.com/support/). The following table contains excerpts from Table 6 of the NMEA Standard which defines the variables for the NMEA logs. The actual format for each parameter is indicated after the description.



See the Note in the **GPGGA** log (see page 497) that applies to all NMEA logs.



1. Spaces may only be used in variable text fields.
2. A negative sign "-" (HEX 2D) is the first character in a Field if the value is negative. The sign is omitted if the value is positive.
3. All data fields are delimited by a comma (,).
4. Null fields are indicated by no data between two commas (,,). Null fields indicate invalid data or no data available.
5. The NMEA Standard requires that message length be limited to 82 characters.



| Field Type                   | Symbol    | Definition  |
|------------------------------|-----------|---|
| <b>Special Format Fields</b> |           |   |
| Status                       | A         | Single character field:<br>A = Yes, Data Valid, Warning Flag Clear<br>V = No, Data Invalid, Warning Flag Set  |
| Latitude                     | llll.ll   | Fixed/Variable length field:<br>degrees minutes.decimal - 2 fixed digits of degrees, 2 fixed digits of mins and a <i>variable</i> number of digits for decimal-fraction of mins. Leading zeros always included for degrees and mins to maintain fixed length. The decimal point and associated decimal-fraction are optional if full resolution is not required   |
| Longitude                    | yyyyy.yy  | Fixed/Variable length field:<br>degrees minutes.decimal - 3 fixed digits of degrees, 2 fixed digits of mins and a <i>variable</i> number of digits for decimal-fraction of mins. Leading zeros always included for degrees and mins to maintain fixed length. The decimal point and associated decimal-fraction are optional if full resolution is not required   |
| Time                         | hhmmss.ss | Fixed/Variable length field:<br>hours minutes seconds.decimal - 2 fixed digits of hours, 2 fixed digits of mins, 2 fixed digits of seconds and <i>variable</i> number of digits for decimal-fraction of seconds. Leading zeros always included for hours, mins and seconds to maintain fixed length. The decimal point and associated decimal-fraction are optional if full resolution is not required. |
| Defined field                |           | Some fields are specified to contain predefined constants, most often alpha characters. Such a field is indicated in this standard by the presence of one or more valid characters. Excluded from the list of allowable characters are the following which are used to indicate field types within this standard:<br>"A", "a", "c", "hh", "hhmmss.ss", "llll.ll", "x", "yyyyy.yy"                       |
| <b>Numeric Value Fields</b>  |           |   |
| Variable numbers             | x.x       | Variable length integer or floating numeric field. Optional leading and trailing zeros. The decimal point and associated decimal-fraction are optional if full resolution is not required (example: 73.10 = 73.1 = 073.1 = 73)  |
| Fixed HEX field              | hh__      | Fixed length HEX numbers only, MSB on the left  |
| <b>Information Fields</b>    |           |   |

---

| <b>Field Type</b>  | <b>Symbol</b> | <b>Definition</b>   |
|--------------------|---------------|---|
| Variable text      | c--c          | Variable length valid character field                         |
| Fixed alpha field  | aa____        | Fixed length field of uppercase or lowercase alpha characters |
| Fixed number field | xx____        | Fixed length field of numeric characters                      |
| Fixed text field   | cc____        | Fixed length field of valid characters                        |

## 3.92 NOVATELXOBS

### *NovAtel proprietary RTK correction*

**Platform: OEM719, OEM729, OEM7500, OEM7700, OEM7720, PwrPak7, HxGN PIM7500**

NOVATELX is a combined observation and reference station message used to transmit RTK corrections. This is a proprietary message and supports sending data for all systems.

**Message ID: 1618**

**Log Type: Synch**

**Recommended Input:**

```
log com2 novatelxobs ontime 1
```

To calculate the size of the NOVATELXOBS messages, use the following formula.

$$\text{Size} = 168 + s * (6 + p * (54 + f*33))$$

where:

s = number of systems (maximum 8)

p = number of PRN per system (maximum 64)

f = number of signals data per PRN – 1 (maximum 10 signals possible)

**Example size calculations:**

- For 2 systems (GPS and GLONASS), 12 PRN per system, and 2 signals per satellite (L1CA, L2PY)

$$\begin{aligned}\text{Size} &= 168 + 2 * (6 + 12 * (54 + 33)) \\ &= 2268 \text{ bits per second} \\ &= 284 \text{ bytes} + \text{NovAtelXHeader (8 bytes)}\end{aligned}$$

- For 3 systems (GPS, BEIDOU and GLONASS), 12 PRN per system, and 2 signals per satellite (L1CA, L2PY)

$$\begin{aligned}\text{Size} &= 168 + 3 * (6 + 12 * (54 + 33)) \\ &= 3318 \text{ bits per second} \\ &= 415 \text{ bytes} + \text{NovAtelXHeader (8 bytes)}\end{aligned}$$

- For 3 systems (GPS, BEIDOU and GLONASS), 12 PRN per system, and 3 signals per satellite (L1CA, L2PY, L2C)

$$\begin{aligned}\text{Size} &= 168 + 3 * (6 + 12 * (54 + 2*33)) \\ &= 4506 \text{ bits per second} \\ &= 564 \text{ bytes} + \text{NovAtelXHeader (8 bytes)}\end{aligned}$$

## 3.93 NOVATELXREF

*NovAtel proprietary reference station message for use in ALIGN*

**Platform:** OEM719, OEM729, OEM7500, OEM7700, OEM7720, PwrPak7, HxGN PIM7500

NOVATELXREF is a proprietary extended reference station message for use in ALIGN configurations only. This message enables the output of the **MASTERPOS** log (see page 574), **ROVERPOS** log (see page 710) and **ALIGNBSLNENU** log (see page 393) on the rover.

**Message ID:** 1620

**Log Type:** Synch

**Recommended Input:**

```
log com2 novatelxref ontime 1
```

## 3.94 OCEANIXINFO

### 3.95 Oceanix subscription information

**Platform:** OEM719, OEM729, OEM7500, OEM7700, OEM7720, PwrPak7, HxGN PIM7500

This log contains details on the Oceanix subscription.

**Message ID:** 2159

**Log Type:** Asynch

**Recommended Input:**

```
log oceanixinfoa onchanged
```

**ASCII Example:**

```
#OCEANIXINFOA, COM1, 0, 83.0, FINESTEERING, 1987, 253328.270, 02040020, 9ce8, 14635; "QU242:3004:3631", TERM, 80001803, 44, 2018, 0, NEARSHORE*de2b56e3
```

| Field | Field Type               | Description   | Format    | Binary Bytes | Binary Offset |
|-------|--------------------------|---|-----------|--------------|---------------|
| 1     | OCEANIXINFO header       | Log header. See <i>Messages</i> on page 25 for more information.  |           | H            | 0             |
| 2     | PAC                      | Product activation code   | Char [16] | 16           | H             |
| 3     | Type                     | Subscription type (see <i>Table 114: Oceanix Subscription Type</i> on the next page)  | Enum      | 4            | H+16          |
| 4     | Subscription permissions | Services permitted by the subscription (see <i>Table 115: Oceanix Subscription Details Mask</i> on the next page)<br><b>Note:</b> Bits in the Reserved areas of this field may be set, but the Reserved bits should be ignored. | Hex       | 4            | H+20          |
| 5     | Service End Day          | The day of the year when the subscription ends.<br>Service ends at 00:00 UTC on this day.   | Ulong     | 4            | H+24          |
| 6     | Service End Year         | Year that the subscription ends.  | Ulong     | 4            | H+28          |
| 7     | Reserved                 |   | Ulong     | 4            | H+32          |

| Field | Field Type         | Description  | Format | Binary Bytes | Binary Offset |
|-------|--------------------|--|--------|--------------|---------------|
| 8     | Region restriction | For region restricted subscriptions, the type of region restriction (see <i>Table 116: Oceanix Region Restriction</i> below) | Enum   | 4            | H+36          |
| 9     | xxxx               | 32-bit CRC (ASCII and Binary only)   | Ulong  | 4            | H+40          |
| 10    | [CR][LF]           | Sentence terminator (ASCII only)   | -      | -            | -             |

**Table 114: Oceanix Subscription Type**

| ASCII                     | Binary | Description  |
|---------------------------|--------|--|
| UNASSIGNED                | 0      | Decoder has not had an assigned operating mode                         |
| TERM                      | 1      | Term subscription  |
| MODEL                     | 5      | Reserved   |
| BUBBLE                    | 100    | Receiver is operating in an Oceanix-permitted subscription-free bubble |
| INCOMPATIBLE_SUBSCRIPTION | 104    | Subscription is incompatible with this version of firmware             |

**Table 115: Oceanix Subscription Details Mask**

| Bit  | Mask        | Description         |
|------|-------------|---------------------|
| 0    | 0x00000001  | Reserved            |
| 1    | 0x00000002  | Oceanix - H service |
| 2-31 | 0xFFFFFFFFC | Reserved            |

**Table 116: Oceanix Region Restriction**

| ASCII     | Binary | Description   |
|-----------|--------|---|
| NONE      | 0      | Oceanix operation has no region restrictions  |
| GEOGATED  | 1      | Oceanix operation is limited to land regions. GEOGATED is also the default value reported if there is no subscription |
| NEARSHORE | 3      | Oceanix operation is limited to land and near shore (coastal) regions   |

## 3.96 OCEANIXSTATUS

### *Oceanix decoder and subscription status*

**Platform: OEM719, OEM729, OEM7500, OEM7700, OEM7720, PwrPak7, HxGN PIM7500**

This log contains status information for the Oceanix decoder and subscription.

**Message ID: 2160**

**Log Type: Asynch**

**Recommended Input:**

```
log oceanixstatusa onchanged
```

**ASCII Example:**

```
#OCEANIXSTATUSA,COM1,0,89.0,FINESTEERING,1982,315542.430,03000020,049a,32768;ENABLE,LOCKED,IN_REGION*954083ea
```

| Field | Field Type                | Description   | Format | Binary Bytes | Binary Offset |
|-------|---------------------------|---|--------|--------------|---------------|
| 1     | OCEANIXSTATUS header      | Log header. See <i>Messages</i> on page 25 for more information.                                    |        | H            | 0             |
| 2     | Access                    | Access status.<br>ENABLE (1) if the subscription is valid.<br>DISABLE (0) otherwise                 | Enum   | 4            | H             |
| 3     | Sync state                | Decoder data synchronization state (see <i>Table 117: Decoder Data Synchronization State</i> below) | Enum   | 4            | H+4           |
| 4     | Region restriction status | Region restriction status (see <i>Table 118: Region Restriction Status</i> on the next page)        | Enum   | 4            | H+8           |
| 5     | xxxx                      | 32-bit CRC (ASCII and Binary only)  | Ulong  | 4            | H+12          |
| 6     | [CR][LF]                  | Sentence terminator (ASCII only)  | -      | -            | -             |

**Table 117: Decoder Data Synchronization State**

| ASCII     | Binary | Description  |
|-----------|--------|--|
| NO_SIGNAL | 0      | None of the decoders have received data in the last 30 seconds         |
| SEARCH    | 1      | At least one decoder is receiving data and is searching for the format |
| LOCKED    | 2      | At lease one decoder has locked onto the format                        |

**Table 118: Region Restriction Status**

| <b>ASCII</b>  | <b>Binary</b> | <b>Description</b>                             |
|---------------|---------------|--|
| UNKNOWN       | 0             | Region restriction status cannot be determined |
| IN_REGION     | 1             | Receiver is within the permitted region        |
| OUT_OF_REGION | 2             | Receiver is outside the permitted region       |



## 3.97 PASSCOM, PASSXCOM, PASSAUX, PASSUSB, PASSETH1, PASSICOM, PASSNCOM

### *Redirects data*

**Platform: OEM719, OEM729, OEM7500, OEM7700, OEM7720, PwrPak7, HxGN PIM7500**

The pass-through logging feature enables the receiver to redirect any ASCII or binary data, input at a specified port, to any specified receiver port. It allows the receiver to perform bi-directional communications with other devices such as a modem, terminal or another receiver. See also the **INTERFACEMODE** command on page 189.

There are many pass through logs: PASSCOM1, PASSCOM2, PASSCOM3, PASSCOM4, PASSCOM5, PASSCOM6, PASSXCOM1, PASSXCOM2, PASSXCOM3, PASSAUX, PASSETH1, PASSICOM1, PASSICOM2, PASSICOM3, PASSICOM4, PASSICOM5, PASSICOM6, PASSICOM7, PASSNCOM1, PASSNCOM2, PASSNCOM3 allow for redirection of data that is arriving at COM1, COM2, COM3, virtual COM1, virtual COM2 or AUX. PASSCOM4, PASSCOM5 and PASSCOM6 are only available on OEM7700 and OEM7720 receivers. The AUX port is available on some products. PASSUSB1, PASSUSB2, PASSUSB3 are used to redirect data from USB1, USB2 or USB3. PASSETH1 is only available on receivers supporting Ethernet and can be used to redirect data from ETH1.

A pass through log is initiated the same as any other log, that is, log [to-port] [data-type] [trigger]. However, pass-through can be more clearly specified as: log [to-port] [from-port-AB] [onchanged]. Now, the [from-port-AB] field designates the port which accepts data (that is, COM1, COM2, COM3, COM4, COM5, COM6, AUX, USB1, USB2 or USB3) as well as the format in which the data is logged by the [to-port] (A for ASCII or B for Binary).



To pass through data arriving on all ports, use the **PASSTHROUGH** log (see page 614).

When the [from-port-AB] field is suffixed with an [A], all data received by that port is redirected to the [to-port] in ASCII format and logs according to standard NovAtel ASCII format. Therefore, all incoming ASCII data is redirected and output as ASCII data. However, any binary data received is converted to a form of ASCII hexadecimal before it is logged.

When the [from-port-AB] field is suffixed with a [B], all data received by that port is redirected to the [to-port] exactly as it is received. The log header and time tag adhere to standard NovAtel Binary format followed by the pass through data as it was received (ASCII or binary).

Pass through logs are best utilized by setting the [trigger] field as onchanged or onnew.

If the data being injected is ASCII, then the data is grouped together with the following rules:

- blocks of 80 characters
- any block of characters ending in a <CR>
- any block of characters ending in a <LF>
- any block remaining in the receiver code when a timeout occurs (100 ms)

If the data being injected is binary or the port INTERFACEMODE mode is set to GENERIC, then the data is grouped as follows:

- blocks of 80 bytes
- any block remaining in the receiver code when a timeout occurs (100 ms)

If a binary value is encountered in an ASCII output, then the byte is output as a hexadecimal byte preceded by a backslash and an x. For example 0A is output as \x0A. An actual '\\' in the data is output as \\ . The output counts as one pass through byte although it is four characters.

The first character of each pass-through record is time tagged in GPS reference weeks and seconds.

|                  |                         |
|------------------|-------------------------|
| <b>PASSAUX</b>   | <b>Message ID: 690</b>  |
| <b>PASSCCOM1</b> | <b>Message ID: 1893</b> |
| <b>PASSCCOM2</b> | <b>Message ID: 1894</b> |
| <b>PASSCCOM3</b> | <b>Message ID: 1895</b> |
| <b>PASSCCOM4</b> | <b>Message ID: 1930</b> |
| <b>PASSCCOM5</b> | <b>Message ID: 1937</b> |
| <b>PASSCCOM6</b> | <b>Message ID: 1938</b> |
| <b>PASSCOM1</b>  | <b>Message ID: 233</b>  |
| <b>PASSCOM2</b>  | <b>Message ID: 234</b>  |
| <b>PASSCOM3</b>  | <b>Message ID: 235</b>  |
| <b>PASSCOM4</b>  | <b>Message ID: 1384</b> |
| <b>PASSCOM5</b>  | <b>Message ID: 1576</b> |
| <b>PASSCOM6</b>  | <b>Message ID: 1577</b> |
| <b>PASSCOM7</b>  | <b>Message ID: 1701</b> |
| <b>PASSCOM8</b>  | <b>Message ID: 1702</b> |
| <b>PASSCOM9</b>  | <b>Message ID: 1703</b> |
| <b>PASSCOM10</b> | <b>Message ID: 1704</b> |
| <b>PASSETH1</b>  | <b>Message ID: 1209</b> |
| <b>PASSICOM1</b> | <b>Message ID: 1250</b> |
| <b>PASSICOM2</b> | <b>Message ID: 1251</b> |
| <b>PASSICOM3</b> | <b>Message ID: 1252</b> |
| <b>PASSICOM4</b> | <b>Message ID: 1385</b> |
| <b>PASSICOM5</b> | <b>Message ID: 2119</b> |
| <b>PASSICOM6</b> | <b>Message ID: 2120</b> |
| <b>PASSICOM7</b> | <b>Message ID: 2121</b> |
| <b>PASSNCOM1</b> | <b>Message ID: 1253</b> |
| <b>PASSNCOM2</b> | <b>Message ID: 1254</b> |
| <b>PASSNCOM3</b> | <b>Message ID: 1255</b> |
| <b>PASSUSB1</b>  | <b>Message ID: 607</b>  |
| <b>PASSUSB2</b>  | <b>Message ID: 608</b>  |
| <b>PASSUSB3</b>  | <b>Message ID: 609</b>  |
| <b>PASSXCOM1</b> | <b>Message ID: 405</b>  |

**PASSXCOM2      Message ID: 406****PASSXCOM3      Message ID: 795****Log Type: Asynch****Recommended Input:**

log passcom1a onchanged



Asynchronous logs should only be logged ONCHANGED otherwise the most current data is not output when it is available. This is especially true of the ONTIME trigger, which may cause inaccurate time tags to result.

**ASCII Example 1:**

```
#PASSCOM2A,COM1,0,59.5,FINESTEERING,1337,400920.135,02000000,2b46,1984
;80,
#BESTPOSA,COM3,0,80.0,FINESTEERING,1337,400920.000,02000000,4ca6,1899;
SOL_COMPUT*f9dfab46
#PASSCOM2A,COM1,0,64.0,FINESTEERING,1337,400920.201,02000000,2b46,1984
;80,ED,SINGLE,51.11636326036,-114.03824210485,1062.6015,-
16.2713,WGS84,1.8963,1.0674*807fd3ca
#PASSCOM2A,COM1,0,53.5,FINESTEERING,1337,400920.856,02000000,2b46,1984
;49,,2.2862,"",0.000,0.000,9,9,0,0,0,0,0*20b24878\x0d\x0a*3eef4220
#PASSCOM1A,COM1,0,53.5,FINESTEERING,1337,400922.463,02000000,13ff,1984
;17,
unlog passcom2a\x0d\x0a*ef8d2508
```

**ASCII Example 2:**

```
#PASSCOM2A,COM1,0,53.0,FINESTEERING,1337,400040.151,02000000,2b46,1984;
80,\x99A\x10\x04\x07yN&\xc6\xea\x10\x00\x01\xde\x00\x00\x10\xfe\xbf
\xfe1\xfe\x9c\xf4\x03\xe2\xef\x9f\x1f\xf3\xff\xd6\xff\xc3_A~z\xaa
\xfe\xbf\xf9\xd3\xf8\xd4\xf4-\xe8kHo\xe2\x00>\xe0QOC>\xc3\x9c\x11\xff
\x7f\xf4\xa1\xf3t\xf4'\xf4xvo\xe6\x00\x9d*dcd2e989
```

In the example, note that '~' is a printable character.

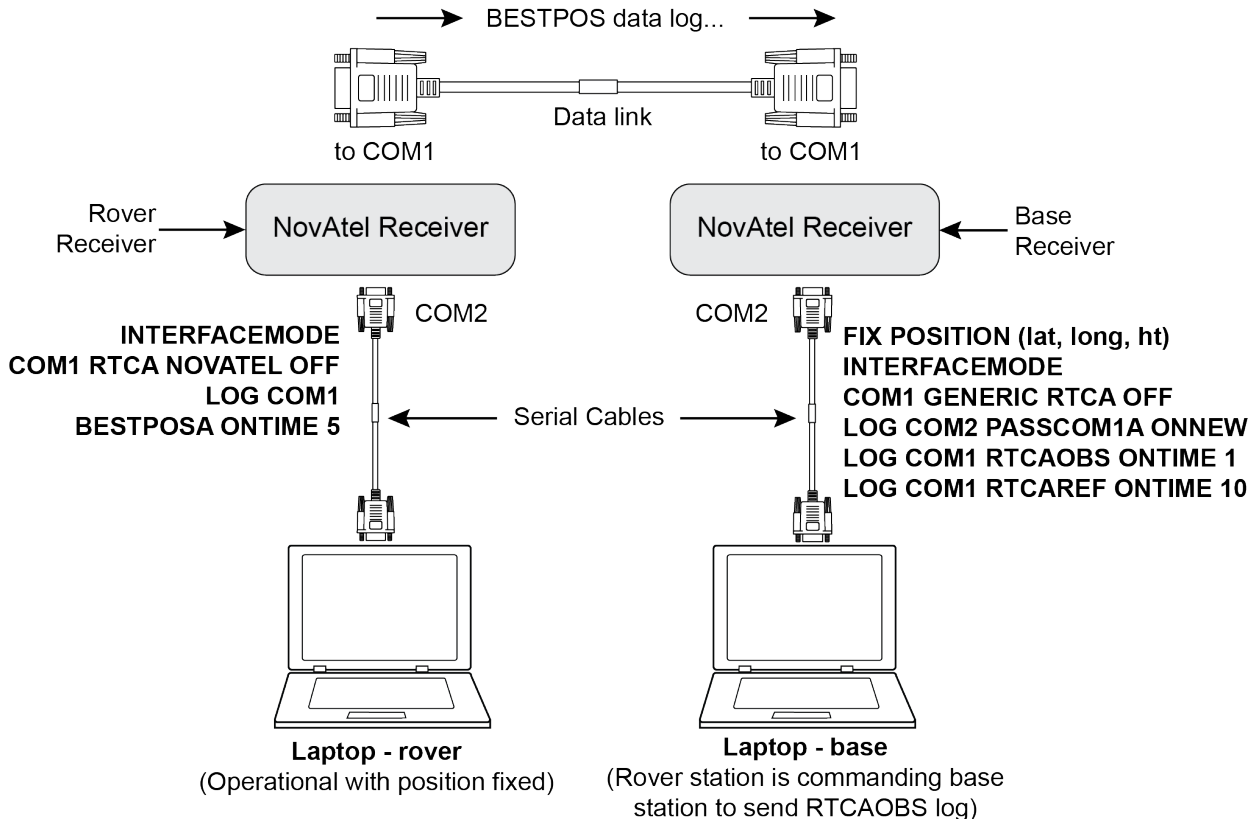

For example, you could connect two OEM7 family receivers together via their COM1 ports such as in the *Figure 13: Pass Through Log Data* on the next page (a rover station to base station scenario). If the rover station is logging BESTPOSA data to the base station, it is possible to use the pass through logs to pass through the received BESTPOSA data to a disk file (let's call it diskfile.log) at the base station host PC hard disk.

**Figure 13: Pass Through Log Data**

Under default conditions, the two receivers "chatter" back and forth with the Invalid Command Option message (due to the command interpreter in each receiver not recognizing the command prompts of the other receiver). The chattering in turn causes the accepting receiver to transmit new pass through logs with the response data from the other receiver. To avoid the chattering problem, use the **INTERFACEMODE** command (see page 189) on the accepting port to disable error reporting from the receiving port command interpreter.

If the accepting port's error reporting is disabled by INTERFACEMODE, the BESTPOSA data record passes through and creates two records.

The reason that two records are logged from the accepting receiver is the first record was initiated by receipt of the BESTPOSA first terminator <CR>. The second record followed in response to the BESTPOSA second terminator <LF>.

Note the time interval between the first character received and the terminating <LF> can be calculated by differencing the two GPS reference time tags. This pass through feature is useful for time tagging the arrival of external messages. These messages can be any user related data. When using this feature for tagging external events, it is recommended that the rover receiver be disabled from interpreting commands so the receiver does not respond to the messages, using the **INTERFACEMODE** command (see page 189).

If the BESTPOSB binary log data is input to the accepting port (log com2 passcom1a onchanged), the BESTPOSB binary data at the accepting port is converted to a variation of ASCII hexadecimal before it is passed through to com2 port for logging.

| Field | Field Type     | Description  | Format    | Binary Bytes | Binary Offset |
|-------|----------------|--|-----------|--------------|---------------|
| 1     | PASSCOM header | Log header. See <i>Messages</i> on page 25 for more information. |           | H            | 0             |
| 2     | #bytes         | Number of bytes to follow  | Ulong     | 4            | H             |
| 3     | data           | Message data   | Char [80] | 80           | H+4           |
| 4     | xxxx           | 32-bit CRC (ASCII and Binary only)                               | Ulong     | 4            | H+4+ (#bytes) |
| 5     | [CR][LF]       | Sentence terminator (ASCII only)                                 | -         | -            | -             |

## 3.98 PASSTHROUGH

### *Redirected data from all ports*

**Platform: OEM719, OEM729, OEM7500, OEM7700, OEM7720, PwrPak7, HxGN PIM7500**

This log outputs pass through data from all receiver ports. The behavior is the same as the port specific pass through logs described in *PASSCOM*, *PASSXCOM*, *PASSAUX*, *PASSUSB*, *PASSETH1*, *PASSICOM*, *PASSNCOM* on page 609.

**Message ID: 1342**

**Log Type: Asynch**

**Recommended Input:**

```
log passthrougha onchanged
```

**ASCII Example:**

```
#PASSTHROUGHHA,COM1,0,73.0,FINESTEERING,1625,165965.067,02040008,5fa3,
39275;USB1,80,i\xd3\x00\x87>\xb0\x00'\x91\xb3"\xa0D?\xaa\xb2\x00\x07op
\x18@\x05\xe9\xd4\x08\xe7\x03\x7f\xfd\x18{\x80w\xff\xf2N_cy\x11\x80\
x0bc\xdc\x01@\x00\xdf\r\xb1`\x873\xff\x81]\x7f\xe3\xff\xea\x83v\x08M\
xd8?\xfcr\xf7\x01\x18\x00\x17\x1d2\xd1\xd1b\x00*5cb8bd9a
```

| Field | Field type         | Description  | Format    | Binary Bytes | Binary Offset |
|-------|--------------------|--|-----------|--------------|---------------|
| 1     | PASSTHROUGH header | Log header. See <i>Messages</i> on page 25 for more information. |           | H            | 0             |
| 2     | Port               | See <i>Table 58: COM Port Identifiers</i> on page 327            | Enum      | 4            | H             |
| 3     | #bytes             | Number of bytes to follow  | Ulong     | 4            | H+4           |
| 4     | data               | Message data   | Char [80] | 80           | H+8           |
| 5     | xxxx               | 32-bit CRC (ASCII and Binary only)                               | Ulong     | 4            | H+8+#bytes    |
| 6     | [CR][LF]           | Sentence terminator (ASCII only)                                 | -         | -            | -             |

## 3.99 PDPPOS

### *PDP filter position*

**Platform: OEM719, OEM729, OEM7500, OEM7700, OEM7720, PwrPak7, HxGN PIM7500**

The PDPPOS log contains the receiver position computed by the receiver with the PDP filter enabled. See also the **PDPFILTER** command on page 249.

**Message ID: 469**

**Log Type: Synch**

**Recommended Input:**

```
log pdpposa ontime 1
```

**ASCII Example:**

```
#PDPPOSA, COM1, 0, 75.5, FINESTEERING, 1431, 494991.000, 02040000, a210, 35548;
SOL_COMPUTED, SINGLE, 51.11635010310, -114.03832575772, 1065.5019, -
16.9000, WGS84, 4.7976, 2.0897, 5.3062, "", 0.000, 0.000, 8, 8, 0, 0, 0, 0, 0*3cbf
a646
```

| Field | Field type    | Description  | Format | Binary Bytes | Binary Offset |
|-------|---------------|--|--------|--------------|---------------|
| 1     | PDPPOS header | Log header. See <i>Messages</i> on page 25 for more information.   |        | H            | 0             |
| 2     | sol status    | Solution status (refer to <i>Table 73: Solution Status</i> on page 419)  | Enum   | 4            | H             |
| 3     | pos type      | Position type (refer to <i>Table 74: Position or Velocity Type</i> on page 420)  | Enum   | 4            | H+4           |
| 4     | lat           | Latitude (degrees)   | Double | 8            | H+8           |
| 5     | lon           | Longitude (degrees)  | Double | 8            | H+16          |
| 6     | hgt           | Height above mean sea level (m)  | Double | 8            | H+24          |
| 7     | undulation    | Undulation - the relationship between the geoid and the WGS84 ellipsoid (m) <div style="border: 1px solid black; padding: 5px; margin-top: 10px;">  <p>When using a datum other than WGS84, the undulation value also includes the vertical shift due to differences between the datum in use and WGS84.</p> </div> | Float  | 4            | H+32          |

| Field | Field type                  | Description   | Format  | Binary Bytes | Binary Offset |
|-------|-----------------------------|---|---------|--------------|---------------|
| 8     | datum id#                   | Datum ID number (refer to <i>Table 28: Datum Transformation Parameters</i> on page 116)                     | Enum    | 4            | H+36          |
| 9     | lat $\sigma$                | Latitude standard deviation (m)   | Float   | 4            | H+40          |
| 10    | lon $\sigma$                | Longitude standard deviation (m)  | Float   | 4            | H+44          |
| 11    | hgt $\sigma$                | Height standard deviation (m)   | Float   | 4            | H+48          |
| 12    | stn id                      | Base station ID   | Char[4] | 4            | H+52          |
| 13    | diff_age                    | Differential age in seconds   | Float   | 4            | H+56          |
| 14    | sol_age                     | Solution age in seconds   | Float   | 4            | H+60          |
| 15    | #sats                       | Number of satellites tracked  | Uchar   | 1            | H+64          |
| 16    | #sats soln                  | Number of satellites in the solution  | Uchar   | 1            | H+65          |
| 17    | Reserved                    |   | Uchar   | 1            | H+66          |
| 18    |                             |   | Uchar   | 1            | H+67          |
| 19    |                             |   | Hex     | 1            | H+68          |
| 20    | ext sol stat                | Extended solution status (see <i>Table 77: Extended Solution Status</i> on page 423)                        | Hex     | 1            | H+69          |
| 21    | Galileo and BeiDou sig mask | Galileo and BeiDou signals used mask (see <i>Table 76: Galileo and BeiDou Signal-Used Mask</i> on page 423) | Hex     | 1            | H+70          |
| 22    | GPS and GLONASS sig mask    | GPS and GLONASS signals used mask (see <i>Table 75: GPS and GLONASS Signal-Used Mask</i> on page 422)       | Hex     | 1            | H+71          |
| 23    | xxxx                        | 32-bit CRC (ASCII and Binary only)  | Hex     | 4            | H+72          |
| 24    | [CR][LF]                    | Sentence terminator (ASCII only)  | -       | -            | -             |



## 3.100 PDPSATS

### *Satellites used in PDPPOS solution*

**Platform: OEM719, OEM729, OEM7500, OEM7700, OEM7720, PwrPak7, HxGN PIM7500**

This log lists the used and unused satellites for the corresponding PDPPOS solution. It also describes the signals of the used satellites and reasons for exclusions.

**Message ID: 1234**

**Log Type: Synch**

**Recommended Input:**

```
log pdpsatsa ontime 1
```

**Abbreviated ASCII Example:**

```
<PDPSATS COM1 0 80.0 FINESTEERING 1690 603073.000 02000008 be33 43488
< 21
< GPS 11 GOOD 00000001
< GPS 27 GOOD 00000001
...
< GPS 1 GOOD 00000001
< GPS 7 GOOD 00000001
< SBAS 133 NOTUSED 00000000
< SBAS 138 NOTUSED 00000000
< SBAS 135 NOTUSED 00000000
< GLONASS 10-7 GOOD 00000001
< GLONASS 21+4 GOOD 00000001
...
< GLONASS 12-1 GOOD 00000001
< GLONASS 11 GOOD 00000001
```

| Field | Field type     | Description  | Format | Binary Bytes | Binary Offset |
|-------|----------------|--|--------|--------------|---------------|
| 1     | PDPSATS header | Log header. See <i>Messages</i> on page 25 for more information.         |        | H            | 0             |
| 2     | #entries       | Number of records to follow  | Ulong  | 4            | H             |
| 3     | system         | See <i>Table 102: Satellite System</i> on page 532                       | Enum   | 4            | H+4           |
| 4     | Satellite ID   | Satellite identifier   | Ulong  | 4            | H+8           |
| 5     | Status         | Satellite status (see <i>Table 79: Observation Statuses</i> on page 426) | Enum   | 4            | H+12          |

| Field | Field type                               | Description   | Format | Binary Bytes | Binary Offset    |
|-------|--|---|--------|--------------|------------------|
| 6     | Status mask                              | See Table 80: <i>BESTSATS GPS Signal Mask</i> on page 427, Table 81: <i>BESTSATS GLONASS Signal Mask</i> on page 428, Table 82: <i>BESTSATS Galileo Signal Mask</i> on page 428, and Table 83: <i>BESTSATS BeiDou Signal Mask</i> on page 428 | Hex    | 4            | H+16             |
| 7     | Next satellite offset = H+4+ (#sat x 16) |   |        |              |                  |
| 8     | xxxx                                     | 32-bit CRC (ASCII and Binary only)  | Ulong  | 4            | H+4+ (#sat x 16) |
| 9     | [CR][LF]                                 | Sentence terminator (ASCII only)  | -      | -            | -                |

## 3.101 PDPVEL

### *PDP filter velocity*

**Platform: OEM719, OEM729, OEM7500, OEM7700, OEM7720, PwrPak7, HxGN PIM7500**

The PDPVEL log contains the pseudorange velocity computed by the receiver with the PDP filter enabled. See also the **PDPFILTER** command on page 249.

**Message ID: 470**

**Log Type: Synch**

**Recommended Input:**

```
log pdpvela ontime 1
```

**ASCII Example:**

```
#PDPVELA,COM1,0,75.0,FINESTEERING,1430,505990.000,02000000,b886,2859;S  
OL_COMPUTED,SINGLE,0.150,0.000,27.4126,179.424617,-0.5521,0.0*7746b0fe
```

| Field | Field type    | Description  | Format | Binary Bytes | Binary Offset |
|-------|---------------|--|--------|--------------|---------------|
| 1     | PDPVEL header | Log header. See <i>Messages</i> on page 25 for more information.   |        | H            | 0             |
| 2     | sol status    | Solution status (refer to <i>Table 73: Solution Status</i> on page 419)  | Enum   | 4            | H             |
| 3     | vel type      | Velocity type (refer to <i>Table 74: Position or Velocity Type</i> on page 420)  | Enum   | 4            | H+4           |
| 4     | latency       | A measure of the latency in the velocity time tag in seconds. It should be subtracted from the time to give improved results     | Float  | 4            | H+8           |
| 5     | age           | Differential age in seconds  | Float  | 4            | H+12          |
| 6     | hor spd       | Horizontal speed over ground, in metres per second   | Double | 8            | H+16          |
| 7     | trk gnd       | Actual direction of motion over ground (track over ground) with respect to True North, in degrees                                | Double | 8            | H+24          |
| 8     | height        | Height in metres where positive values indicate increasing altitude (up) and negative values indicate decreasing altitude (down) | Double | 8            | H+32          |
| 9     | Reserved      |  | Float  | 4            | H+40          |
| 10    | xxxx          | 32-bit CRC (ASCII and Binary only)   | Ulong  | 4            | H+44          |

| <b>Field</b> | <b>Field type</b> | <b>Description</b>               | <b>Format</b> | <b>Binary Bytes</b> | <b>Binary Offset</b> |
|--------------|-------------------|----------------------------------|---------------|---------------------|----------------------|
| 11           | [CR]<br>[LF]      | Sentence terminator (ASCII only) | -             | -                   | -                    |

## 3.102 PDPXYZ

### *PDP filter Cartesian position and velocity*

**Platform: OEM719, OEM729, OEM7500, OEM7700, OEM7720, PwrPak7, HxGN PIM7500**

The PDPXYZ log contains the Cartesian position in X, Y and Z coordinates as computed by the receiver with the PDP filter enabled. See also the **PDPFILTER** command on page 249.

**Message ID: 471**

**Log Type: Synch**

**Recommended Input:**

```
log pdpxyza ontime 1
```

**ASCII Example:**

```
#PDPXYZA,COM1,0,75.5,FINESTEERING,1431,494991.000,02040000,33ce,35548;
SOL_COMPUTED,SINGLE,-1634531.8128,-
3664619.4862,4942496.5025,2.9036,6.1657,3.0153,SOL_COMPUTED,SINGLE,-
2.5588e-308,-3.1719e-308,3.9151e-
308,0.0100,0.0100,0.0100,"",0.150,0.000,0.000,8,8,0,0,0,0,0,0*a20dbd4f
```

| Field | Field type    | Description   | Format | Binary Bytes | Binary Offset |
|-------|---------------|---|--------|--------------|---------------|
| 1     | PDPXYZ header | Log header. See <i>Messages</i> on page 25 for more information.                |        | H            | 0             |
| 2     | P-sol status  | Solution status (refer to <i>Table 73: Solution Status</i> on page 419)         | Enum   | 4            | H             |
| 3     | pos type      | Position type (refer to <i>Table 74: Position or Velocity Type</i> on page 420) | Enum   | 4            | H+4           |
| 4     | P-X           | Position X-coordinate (m)   | Double | 8            | H+8           |
| 5     | P-Y           | Position Y-coordinate (m)   | Double | 8            | H+16          |
| 6     | P-Z           | Position Z-coordinate (m)   | Double | 8            | H+24          |
| 7     | P-X $\sigma$  | Standard deviation of P-X (m)   | Float  | 4            | H+32          |
| 8     | P- Y $\sigma$ | Standard deviation of P-Y (m)   | Float  | 4            | H+36          |
| 9     | P-Z $\sigma$  | Standard deviation of P-Z (m)   | Float  | 4            | H+40          |
| 10    | V-sol status  | Solution status (refer to <i>Table 73: Solution Status</i> on page 419)         | Enum   | 4            | H+44          |

| Field | Field type                  | Description  | Format  | Binary Bytes | Binary Offset |
|-------|-----------------------------|--|---------|--------------|---------------|
| 11    | vel type                    | Velocity type (refer to <i>Table 74: Position or Velocity Type</i> on page 420)  | Enum    | 4            | H+48          |
| 12    | V-X                         | Velocity vector along X-axis (m)   | Double  | 8            | H+52          |
| 13    | V-Y                         | Velocity vector along Y-axis (m)   | Double  | 8            | H+60          |
| 14    | V-Z                         | Velocity vector along Z-axis (m)   | Double  | 8            | H+68          |
| 15    | V-X $\sigma$                | Standard deviation of V-X (m)  | Float   | 4            | H+76          |
| 16    | V-Y $\sigma$                | Standard deviation of V-Y (m)  | Float   | 4            | H+80          |
| 17    | V-Z $\sigma$                | Standard deviation of V-Z (m)  | Float   | 4            | H+84          |
| 18    | stn ID                      | Base station ID  | Char[4] | 4            | H+88          |
| 19    | V-latency                   | A measure of the latency in the velocity time tag in seconds. It should be subtracted from the time to give improved results | Float   | 4            | H+92          |
| 20    | diff_age                    | Differential age in seconds  | Float   | 4            | H+96          |
| 21    | sol_age                     | Solution age in seconds  | Float   | 4            | H+100         |
| 22    | #sats                       | Number of satellite vehicles tracked   | Uchar   | 1            | H+104         |
| 23    | #sats soln                  | Number of satellite vehicles used in solution  | Uchar   | 1            | H+105         |
| 24    | Reserved                    |  | Uchar   | 1            | H+106         |
| 25    |                             |  | Uchar   | 1            | H+107         |
| 26    |                             |  | Uchar   | 1            | H+108         |
| 27    | ext sol stat                | Extended solution status (see <i>Table 77: Extended Solution Status</i> on page 423)   | Hex     | 1            | H+109         |
| 28    | Galileo and BeiDou sig mask | Galileo and BeiDou signals used mask (see <i>Table 76: Galileo and BeiDou Signal-Used Mask</i> on page 423)                  | Hex     | 1            | H+110         |
| 29    | GPS and GLONASS sig mask    | GPS and GLONASS signals used mask (see <i>Table 75: GPS and GLONASS Signal-Used Mask</i> on page 422)                        | Hex     | 1            | H+111         |
| 30    | xxxx                        | 32-bit CRC (ASCII and Binary only)   | Hex     | 4            | H+112         |
| 31    | [CR][LF]                    | Sentence terminator (ASCII only)   | -       | -            | -             |

## 3.103 PORTSTATS

### *Port statistics*

**Platform: OEM719, OEM729, OEM7500, OEM7700, OEM7720, PwrPak7, HxGN PIM7500**

This log conveys various status parameters of the receiver's communication ports. The receiver maintains a running count of a variety of status indicators of the data link. This log outputs a report of those indicators.

**Message ID: 72**

**Log Type: Polled**

**Recommended Input:**

```
log portstatsa once
```

**ASCII example:**

```
#PORTSTATSA,USB1,0,69.5,FINESTEERING,1971,489026.000,02004020,a872,144
34;29,COM1,0,3109742555,0,0,435636653,0,0,0,0,COM2,0,207,0,0,32,0,0,0,
0,COM3,0,207,0,0,32,0,0,0,0,FILE,0,0,0,0,0,0,0,0,XCOM1,0,7,0,0,0,0,0
,0,0,XCOM2,0,7,0,0,0,0,0,0,0,USB1,175513,21321491,175513,0,0,0,0,0,0,U
SB2,0,0,0,0,0,0,0,0,0,USB3,0,0,0,0,0,0,0,0,0,XCOM3,0,7,0,0,0,0,0,0,0,C
OM4,139542424,189379232,139542424,0,69771230,0,0,0,0,ICOM1,0,0,0,0,0,0,0
,0,0,0,ICOM2,0,0,0,0,0,0,0,0,0,ICOM3,0,0,0,0,0,0,0,0,0,NCOM1,0,0,0,0,0,0
,0,0,0,0,NCOM2,0,0,0,0,0,0,0,0,0,NCOM3,0,0,0,0,0,0,0,0,0,ICOM4,0,0,0,0,0
,0,0,0,0,0,WCOM1,0,394864554,0,0,0,0,0,0,0,COM5,0,6,0,0,4,0,0,0,0,CCOM
1,0,0,0,0,0,0,0,0,0,CCOM2,0,0,0,0,0,0,0,0,0,CCOM3,0,0,0,0,0,0,0,0,0,CC
OM4,0,0,0,0,0,0,0,0,0,0,CCOM5,0,0,0,0,0,0,0,0,0,0,CCOM6,0,0,0,0,0,0,0,0,0,0,
ICOM5,0,0,0,0,0,0,0,0,0,ICOM6,0,0,0,0,0,0,0,0,0,ICOM7,0,0,0,0,0,0,0,0,0,0,
0*b9c28761
```



Parity and framing errors occur for COM ports if poor transmission lines are encountered or if there is an incompatibility in the data protocol. If errors occur, you may need to confirm the bit rate, number of data bits, number of stop bits and parity of both the transmit and receiving ends. Characters may be dropped when the CPU is overloaded.

| Field | Field type       | Description   | Format | Binary Bytes | Binary Offset |
|-------|------------------|---|--------|--------------|---------------|
| 1     | PORTSTATS header | Log header. See <i>Messages</i> on page 25 for more information.      |        | H            | 0             |
| 2     | #port            | Number of ports with information to follow                            | Long   | 4            | H             |
| 3     | port             | Refer to <i>Table 31: Communications Port Identifiers</i> on page 130 | Enum   | 4            | H+4           |

| Field | Field type                                  | Description  | Format | Binary Bytes | Binary Offset            |
|-------|---|--|--------|--------------|--------------------------|
| 4     | rx chars                                    | Total number of characters received through this port          | Ulong  | 4            | H+8                      |
| 5     | tx chars                                    | Total number of characters transmitted through this port       | Ulong  | 4            | H+12                     |
| 6     | acc rx chars                                | Total number of accepted characters received through this port | Ulong  | 4            | H+16                     |
| 7     | dropped rx chars                            | Number of software overruns in receive                         | Ulong  | 4            | H+20                     |
| 8     | interrupts                                  | Number of interrupts on this port                              | Ulong  | 4            | H+24                     |
| 9     | breaks                                      | Number of breaks (only for serial ports)                       | Ulong  | 4            | H+28                     |
| 10    | par err                                     | Number of parity errors (only for serial ports)                | Ulong  | 4            | H+32                     |
| 11    | frame err                                   | Number of framing errors (only for serial ports)               | Ulong  | 4            | H+36                     |
| 12    | rx overruns                                 | Number of hardware overruns in receive                         | Ulong  | 4            | H+40                     |
| 13    | Next port offset = $H+4+(\#port \times 40)$ |  |        |              |                          |
| 14    | xxxx  | 32-bit CRC (ASCII and Binary only)                             | Ulong  | 4            | $H+4+(\#port \times 40)$ |
| 15    | [CR][LF]                                    | Sentence terminator (ASCII only)                               | -      | -            | -                        |



## 3.104 PPPPOS

### *PPP filter position*

**Platform: OEM719, OEM729, OEM7500, OEM7700, OEM7720, PwrPak7, HxGN PIM7500**

This log contains the position solution computed by the PPP filter.

**Message ID: 1538**

**Log Type: Synch**

**Recommended Input:**

```
log pppposa ontime 1
```

**ASCII Example:**

```
#PPPPOSA,COM1,0,80.0,FINESTEERING,1735,345300.000,02000000,6f47,44027;
SOL_COMPUTED,PPP,51.11635350286,-114.03819287079,1064.5365,-
16.9000,WGS84,0.0375,0.0460,0.0603,"0",4.000,0.000,12,12,12,12,0,00,00
,03*ef17d668
```

| Field | Field type    | Description  | Format | Binary Bytes | Binary Offset |
|-------|---------------|--|--------|--------------|---------------|
| 1     | PPPPOS header | Log header. See <i>Messages</i> on page 25 for more information.                         |        | H            | 0             |
| 2     | Status        | Solution status (see <i>Table 73: Solution Status</i> on page 419)                       | Enum   | 4            | H             |
| 3     | Type          | Position type (see <i>Table 119: Position Type</i> on the next page)                     | Enum   | 4            | H+4           |
| 4     | lat           | Latitude (degrees)   | Double | 8            | H+8           |
| 5     | lon           | Longitude (degrees)  | Double | 8            | H+16          |
| 6     | hgt           | Height above mean sea level (m)  | Double | 8            | H+24          |
| 7     | undulation    | Undulation - the relationship between the geoid and the WGS84 ellipsoid (m) <sup>a</sup> | Float  | 4            | H+32          |
| 8     | datum id#     | Datum ID number (see <i>Table 28: Datum Transformation Parameters</i> on page 116)       | Enum   | 4            | H+36          |
| 9     | lat $\sigma$  | Latitude standard deviation (m)  | Float  | 4            | H+40          |
| 10    | lon $\sigma$  | Longitude standard deviation (m)   | Float  | 4            | H+44          |

<sup>a</sup>When using a datum other than WGS84, the undulation value also includes the vertical shift due to differences between the datum in use and WGS84.

| Field | Field type               | Description   | Format  | Binary Bytes | Binary Offset |
|-------|--------------------------|---|---------|--------------|---------------|
| 11    | hgt $\sigma$             | Height standard deviation (m)   | Float   | 4            | H+48          |
| 12    | stn id                   | Base station ID   | Char[4] | 4            | H+52          |
| 13    | diff_age                 | Differential age in seconds   | Float   | 4            | H+56          |
| 14    | sol_age                  | Solution age in seconds   | Float   | 4            | H+60          |
| 15    | #SVs                     | Number of satellites tracked  | Uchar   | 1            | H+64          |
| 16    | #solnSVs                 | Number of satellites vehicles used in solution  | Uchar   | 1            | H+65          |
| 17    | #ggL1                    | Number of GPS plus GLONASS plus BDS L1/B1 used in solution  | Uchar   | 1            | H+66          |
| 18    | #solnMultiSVs            | Number of satellites with multi-frequency signals used in solution  | Uchar   | 1            | H+67          |
| 19    | Reserved                 |   | Hex     | 1            | H+68          |
| 20    | ext sol stat             | Extended solution status (see <i>Table 77: Extended Solution Status</i> on page 423)  | Hex     | 1            | H+69          |
| 21    | Reserved                 |   | Hex     | 1            | H+70          |
| 22    | GPS and GLONASS sig mask | GPS and GLONASS signals used mask (see <i>Table 75: GPS and GLONASS Signal-Used Mask</i> on page 422 or <i>Table 76: Galileo and BeiDou Signal-Used Mask</i> on page 423) | Hex     | 1            | H+71          |
| 23    | xxxx                     | 32-bit CRC (ASCII and Binary only)  | Ulong   | 4            | H+72          |
| 24    | [CR][LF]                 | Sentence terminator (ASCII only)  | -       | -            | -             |

**Table 119: Position Type**

| ASCII                | Binary | Description                     |
|----------------------|--------|---------------------------------|
| NONE                 | 0      | No solution                     |
| PPP_CONVERGING       | 68     | Converging TerraStar-C solution |
| PPP                  | 69     | Converged TerraStar-C solution  |
| PPP_BASIC_CONVERGING | 77     | Converging TerraStar-L solution |
| PPP_BASIC            | 78     | Converged TerraStar-L solution  |

## 3.105 PPSATS

### *Satellites used in the PPPPOS solution*

**Platform: OEM719, OEM729, OEM7500, OEM7700, OEM7720, PwrPak7, HxGN PIM7500**

This log lists the used and unused satellites for the corresponding PPPPOS solution. It also describes the signals of the used satellites and reasons for exclusions.

**Message ID: 1541**

**Log Type: Synch**

**Recommended Input:**

```
log pppsatsa ontime 1
```

**Abbreviated ASCII Example:**

```
<PPPSATS COM1 0 80.0 FINESTEERING 1735 345300.000 02000000 ce3f 44027
< 12
< GPS 3 GOOD 00000003
< GPS 5 GOOD 00000003
< GPS 6 GOOD 00000003
< GPS 7 GOOD 00000003
< GPS 8 GOOD 00000003
< GPS 10 GOOD 00000003
< GPS 13 GOOD 00000003
< GPS 16 GOOD 00000003
< GPS 19 GOOD 00000003
< GPS 23 GOOD 00000003
< GPS 26 GOOD 00000003
< GPS 28 GOOD 00000003
```

| Field | Field type     | Description   | Format | Binary Bytes | Binary Offset |
|-------|----------------|---|--------|--------------|---------------|
| 1     | PPPSATS header | Log header. See <i>Messages</i> on page 25 for more information.      |        | H            | 0             |
| 2     | #entries       | Number of records to follow   | Ulong  | 4            | H             |
| 3     | System         | Satellite system (see <i>Table 102: Satellite System</i> on page 532) | Enum   | 4            | H+4           |

| Field | Field type                                      | Description   | Format | Binary Bytes | Binary Offset        |
|-------|---|---|--------|--------------|----------------------|
| 4     | Satellite ID                                    | In binary logs, the satellite ID field is 4 bytes. The 2 lowest-order bytes, interpreted as a USHORT, are the system identifier: for instance, the PRN for GPS, or the slot for GLONASS. The 2 highest-order bytes are the frequency channel for GLONASS, interpreted as a SHORT and zero for all other systems.<br><br>In ASCII and abbreviated ASCII logs, the satellite ID field is the system identifier. If the system is GLONASS and the frequency channel is not zero, then the signed channel is appended to the system identifier. For example, slot 13, frequency channel -2 is output as 13-2. | Ulong  | 4            | H+8                  |
| 5     | Status  | Satellite status (see <i>Table 79: Observation Statuses</i> on page 426)  | Enum   | 4            | H+12                 |
| 6     | Signal Mask                                     | Signals used in the solution (see <i>Table 80: BESTSATS GPS Signal Mask</i> on page 427, <i>Table 81: BESTSATS GLONASS Signal Mask</i> on page 428, <i>Table 82: BESTSATS Galileo Signal Mask</i> on page 428 and <i>Table 83: BESTSATS BeiDou Signal Mask</i> on page 428)   | Hex    | 4            | H+16                 |
| 7     | Next satellite offset = H + 4 + (#entries x 16) |   |        |              |                      |
| 8     | xxxx  | 32-bit CRC (ASCII and Binary only)  | Ulong  | 4            | H+4+ (#entries x 16) |
| 9     | [CR][LF]  | Sentence terminator (ASCII only)  | -      | -            | -                    |

## 3.106 PROFILEINFO

### *Profile information in NVM*

**Platform: OEM719, OEM729, OEM7500, OEM7700, OEM7720, PwrPak7, HxGN PIM7500**

This log outputs a list of Profiles in the system. Refer also to the **PROFILE** command on page 273.



A list may consist of a maximum of 20 profiles.

**Message ID: 1412**

**Log Type: Polled**

**Recommended Input:**

```
log profileinfoa onchanged
```

**ASCII Examples:**

```
#PROFILEINFOA,COM1,0,84.0,UNKNOWN,0,17539.339,024c0020,ae3a,10526;
"BASE",0,2,
"LOG VERSION",
"SERIALCONFIG COM2 230400"*0ad5cda5
```

| Field | Field Type                     | Description  | Format           | Binary Bytes  | Binary Offset |
|-------|--------------------------------|--|------------------|---------------|---------------|
| 1     | PROFILEINFO header             | Log header. See <i>Messages</i> on page 25 for more information. | -                | H             | 0             |
| 2     | Name                           | Profile Name   | String [Max 20]  | variable<br>1 | H             |
| 3     | Status Word                    | Refer to <i>Table 120: Status Word</i> on the next page          | Ulong            | 4             | variable      |
| 4     | # of Commands                  | Number of commands assigned to the Profile                       | Ulong            | 4             | variable      |
| 5     | Command                        | Profile command  | String [Max 150] | variable<br>1 | variable      |
| 6     | Next command offset = variable |  |                  |               |               |

<sup>1</sup>In the binary case, each string field needs to be NULL terminated and additional bytes of padding added to maintain 4-byte alignment, up to the maximum defined by the string size. The next defined field starts immediately at the next 4-byte alignment following the NULL.

| Field | Field Type | Description                        | Format | Binary Bytes | Binary Offset |
|-------|------------|------------------------------------|--------|--------------|---------------|
| 7     | xxxx       | 32-bit CRC (ASCII and Binary only) | Ulong  | 4            | variable      |
| 8     | [CR][LF]   | Sentence terminator (ASCII only)   | -      | -            | -             |

**Table 120: Status Word**

| Bit #   | Mask       | Description   |
|---------|------------|---|
| 0       | 0x00000001 | Activate Flag<br>(0 – Deactivate (default), 1 –Activate)        |
| 1 – 3   | 0x0000000E | Reserved  |
| 4       | 0x00000010 | Command 1 validation Flag<br>(0 – Valid (default), 1 – Invalid) |
| 5       | 0x00000020 | Command 2 validation Flag                                       |
| 6       | 0x00000040 | Command 3 validation Flag                                       |
| 7       | 0x00000080 | Command 4 validation Flag                                       |
| 8       | 0x00000100 | Command 5 validation Flag                                       |
| 9       | 0x00000200 | Command 6 validation Flag                                       |
| 10      | 0x00000400 | Command 7 validation Flag                                       |
| 11      | 0x00000800 | Command 8 validation Flag                                       |
| 12      | 0x00001000 | Command 9 validation Flag                                       |
| 13      | 0x00002000 | Command 10 validation Flag                                      |
| 14      | 0x00004000 | Command 11 validation Flag                                      |
| 15      | 0x00008000 | Command 12 validation Flag                                      |
| 16      | 0x00010000 | Command 13 validation Flag                                      |
| 17      | 0x00020000 | Command 14 validation Flag                                      |
| 18      | 0x00040000 | Command 15 validation Flag                                      |
| 19      | 0x00080000 | Command 16 validation Flag                                      |
| 20      | 0x00100000 | Command 17 validation Flag                                      |
| 21      | 0x00200000 | Command 18 validation Flag                                      |
| 22      | 0x00400000 | Command 19 validation Flag                                      |
| 23      | 0x00800000 | Command 20 validation Flag                                      |
| 24 - 31 | 0xFF000000 | Reserved  |

## 3.107 PSRDOP

### *Pseudorange DOP*

**Platform: OEM719, OEM729, OEM7500, OEM7700, OEM7720, PwrPak7, HxGN PIM7500**

The dilution of precision data is calculated using the geometry of only those satellites currently being tracked and used in the position solution by the receiver. This log is updated once every 60 seconds. Therefore, the total number of data fields output by the log is variable and depends on the number of svcs being tracked.



1. If a satellite is locked out using the **LOCKOUT** command (see page 214), it will still show in the prn list but it will be significantly deweighted in the dop calculation.
2. The vertical dilution of precision can be calculated by:  

$$vdop = \sqrt{pdop^2 - hdop^2}$$
3. If the DOP is not yet calculated, a default value of 9999.0 is displayed.

**Message ID: 174**

**Log Type: Asynch**

**Recommended Input:**

```
log psrdopa onchanged
```

**ASCII Example:**

```
#PSRDOPA,COM1,0,56.5,FINESTEERING,1337,403100.000,02000000,768f,1984;1
.9695,1.7613,1.0630,1.3808,0.8812,5.0,10,14,22,25,1,24,11,5,20,30,7*10
6de10a
```



When operating in differential mode, you require at least four common satellites at the base and rover. The number of common satellites being tracked at large distances is less than at short distances. This is important because the accuracy of GPS and DGPS positions depend a great deal on how many satellites are being used in the solution (redundancy) and the geometry of the satellites being used (DOP). DOP stands for Dilution Of Precision and refers to the geometry of the satellites. A good DOP occurs when the satellites being tracked and used are evenly distributed throughout the sky. A bad DOP occurs when the satellites being tracked and used are not evenly distributed throughout the sky or grouped together in one part of the sky.

| Field | Field type    |  | Format | Binary Bytes | Binary Offset |
|-------|---------------|--|--------|--------------|---------------|
| 1     | PSRDOP header | Log header. See <i>Messages</i> on page 25 for more information. |        | H            | 0             |

| Field | Field type                                |  | Format | Binary Bytes | Binary Offset          |
|-------|---|--|--------|--------------|------------------------|
| 2     | gdop                                      | Geometric dilution of precision - assumes 3D position and receiver clock offset (all 4 parameters) are unknown | Float  | 4            | H                      |
| 3     | pdop                                      | Position dilution of precision - assumes 3D position is unknown and receiver clock offset is known             | Float  | 4            | H+4                    |
| 4     | hdop                                      | Horizontal dilution of precision.  | Float  | 4            | H+8                    |
| 5     | htdop                                     | Horizontal position and time dilution of precision.  | Float  | 4            | H+12                   |
| 6     | tdop                                      | Time dilution of precision - assumes 3D position is known and only the receiver clock offset is unknown        | Float  | 4            | H+16                   |
| 7     | cutoff                                    | GPS elevation cut-off angle  | Float  | 4            | H+20                   |
| 8     | #PRN                                      | Number of satellites PRNs to follow  | Long   | 4            | H+24                   |
| 9     | PRN                                       | PRN of SV PRN tracking, null field until position solution available   | Ulong  | 4            | H+28                   |
| 10... | Next PRN offset = $H+28+(\#prn \times 4)$ |  |        |              |                        |
| 11    | xxxx                                      | 32-bit CRC (ASCII and Binary only)   | Ulong  | 4            | H+28+<br>(#prn<br>x 4) |
| 12    | [CR]<br>[LF]                              | Sentence terminator (ASCII only)   | -      | -            | -                      |



## 3.108 PSRDOP2

### *Pseudorange DOP*

**Platform: OEM719, OEM729, OEM7500, OEM7700, OEM7720, PwrPak7, HxGN PIM7500**

This log is similar to the PSRDOP log but contains the per system Time Dilution of Precision (TDOP).

**Message ID: 1163**

**Log Type: Asynch**

**Recommended Input:**

```
log psrdop2a onchanged
```

**ASCII Example:**

```
#PSRDOP2A,COM1,0,89.5,FINESTEERING,1613,164820.000,02000008,0802,39031;1.6740,1.3010,0.6900,1.1030,2,GPS,0.6890,GLONASS,0.7980*5dd123d0.
```

| Field | Field type                                  | Description  | Format | Binary Bytes | Binary Offset           |
|-------|---|--|--------|--------------|-------------------------|
| 1     | PSRDOP2 header                              | Log header. See <i>Messages</i> on page 25 for more information.   |        | H            | 0                       |
| 2     | GDOP  | Geometric dilution of precision - assumes 3D position and receiver clock offset (all 4 parameters) are unknown | Float  | 4            | H                       |
| 3     | PDOP  | Position dilution of precision - assumes 3D position is unknown and receiver clock offset is known             | Float  | 4            | H+4                     |
| 4     | HDOP  | Horizontal dilution of precision   | Float  | 4            | H+8                     |
| 5     | VDOP  | Vertical dilution of precision   | Float  | 4            | H+12                    |
| 6     | #systems                                    | Number of systems  | Ulong  | 4            | H+16                    |
| 7     | system                                      | See <i>Table 64: System Used for Timing</i> on page 345  | Enum   | 4            | H+20                    |
| 8     | TDOP  | Time dilution of precision   | Float  | 4            | H+24                    |
| 9     | Next satellite offset = H+20+(#systems x 8) |  |        |              |                         |
| 10    | xxxx  | 32-bit CRC (ASCII and Binary only)   | Hex    | 4            | H+20+<br>(#systems x 8) |
| 11    | [CR][LF]                                    | Sentence terminator (ASCII only)   | -      | -            | -                       |

## 3.109 PSRPOS

### *Pseudorange position*

**Platform: OEM719, OEM729, OEM7500, OEM7700, OEM7720, PwrPak7, HxGN PIM7500**

This log contains the position computed by the receiver, along with three status flags. In addition, it reports other status indicators, including differential age, which is useful in predicting anomalous behavior brought about by outages in differential corrections.

**Message ID: 47**

**Log Type: Synch**

**Recommended Input:**

```
log psrposa ontime 1
```

**ASCII Example:**

```
#PSRPOSA,COM1,0,58.5,FINESTEERING,1419,340037.000,02000040,6326,2724;S  
OL_COMPUTED,SINGLE,51.11636177893,-114.03832396506,1062.5470,-  
16.2712,WGS84,1.8532,1.4199,3.3168,"",0.000,0.000,12,12,0,0,0,06,0,33*  
d200a78c
```



There are DGPS use cases in which the base receiver is not maintained or controlled by the positioning user. For example, the US Coast Guard operates a differential correction service which broadcasts GPS differential corrections over marine radio beacons. As a user, all you need is a marine beacon receiver and a GNSS receiver to achieve positioning accuracy of less than 1 metre. In this case, the Coast Guard owns and operates the base receiver at known coordinates. Other examples of users appearing to use only one GNSS receiver include FM radio station correction services, privately owned radio transmitters and corrections carried by communication satellites. Some of the radio receivers have built-in GNSS receivers and combined antennas, so they even appear to look as one self contained unit.

The major factors degrading GPS signals which can be removed or reduced with differential methods are the atmosphere, ionosphere, satellite orbit errors, and satellite clock errors. Some errors which are not removed include receiver noise and multipath.

| Field | Field type    | Description  | Format | Binary Bytes | Binary Offset |
|-------|---------------|--|--------|--------------|---------------|
| 1     | PSRPOS header | Log header. See <i>Messages</i> on page 25 for more information.   |        | H            | 0             |
| 2     | sol status    | Solution status (see <i>Table 73: Solution Status</i> on page 419) | Enum   | 4            | H             |

| Field | Field type                  | Description   | Format  | Binary Bytes | Binary Offset |
|-------|-----------------------------|---|---------|--------------|---------------|
| 3     | pos type                    | Position type (see <i>Table 74: Position or Velocity Type</i> on page 420)                                  | Enum    | 4            | H+4           |
| 4     | lat                         | Latitude (degrees)  | Double  | 8            | H+8           |
| 5     | lon                         | Longitude (degrees)   | Double  | 8            | H+16          |
| 6     | hgt                         | Height above mean sea level (m)   | Double  | 8            | H+24          |
| 7     | undulation                  | Undulation - the relationship between the geoid and the WGS84 ellipsoid (m) <sup>a</sup>                    | Float   | 4            | H+32          |
| 8     | datum id#                   | Datum ID number (see <i>Table 28: Datum Transformation Parameters</i> on page 116)                          | Enum    | 4            | H+36          |
| 9     | lat $\sigma$                | Latitude standard deviation (m)   | Float   | 4            | H+40          |
| 10    | lon $\sigma$                | Longitude standard deviation (m)  | Float   | 4            | H+44          |
| 11    | hgt $\sigma$                | Height standard deviation (m)   | Float   | 4            | H+48          |
| 12    | stn id                      | Base station ID   | Char[4] | 4            | H+52          |
| 13    | diff_age                    | Differential age in seconds   | Float   | 4            | H+56          |
| 14    | sol_age                     | Solution age in seconds   | Float   | 4            | H+60          |
| 15    | #SVs                        | Number of satellites tracked  | Uchar   | 1            | H+64          |
| 16    | #solnSVs                    | Number of satellite vehicles used in solution   | Uchar   | 1            | H+65          |
| 17    | Reserved                    |   | Uchar   | 1            | H+66          |
| 18    |                             |   | Uchar   | 1            | H+67          |
| 19    |                             |   | Hex     | 1            | H+68          |
| 20    | ext sol stat                | Extended solution status (see <i>Table 77: Extended Solution Status</i> on page 423)                        | Hex     | 1            | H+69          |
| 21    | Galileo and BeiDou sig mask | Galileo and BeiDou signals used mask (see <i>Table 76: Galileo and BeiDou Signal-Used Mask</i> on page 423) | Hex     | 1            | H+70          |
| 22    | GPS and GLONASS sig mask    | GPS and GLONASS signals used mask (see <i>Table 75: GPS and GLONASS Signal-Used Mask</i> on page 422)       | Hex     | 1            | H+71          |
| 23    | xxxx                        | 32-bit CRC (ASCII and Binary only)  | Hex     | 4            | H+72          |
| 24    | [CR][LF]                    | Sentence terminator (ASCII only)  | -       | -            | -             |

<sup>a</sup>When using a datum other than WGS84, the undulation value also includes the vertical shift due to differences between the datum in use and WGS84.

## 3.110 PSRSATS

### *Satellites used in PSRPOS solution*

**Platform: OEM719, OEM729, OEM7500, OEM7700, OEM7720, PwrPak7, HxGN PIM7500**

This log lists the used and unused satellites for the corresponding PSRPOS solution. It also describes the signals of the used satellites and reasons for exclusions.

**Message ID: 1162**

**Log Type: Synch**

**Recommended Input:**

```
log psrsats ontime 1
```

**Abbreviated ASCII Example:**

```
<PSRSATS COM1 0 80.0 FINESTEERING 1729 154910.000 02004000 fea4 11465
< 20
< GPS 31 GOOD 00000003
< GPS 14 GOOD 00000003
< GPS 22 GOOD 00000003
< GPS 11 GOOD 00000003
< GPS 1 GOOD 00000003
< GPS 32 GOOD 00000003
< GPS 18 GOOD 00000003
< GPS 24 GOOD 00000003
< GPS 19 GOOD 00000003
< GLONASS 24+2 GOOD 00000003
< GLONASS 10-7 GOOD 00000003
< GLONASS 9-2 GOOD 00000003
< GLONASS 2-4 GOOD 00000003
< GLONASS 1+1 GOOD 00000003
< GLONASS 11 GOOD 00000003
< GLONASS 17+4 GOOD 00000003
< GLONASS 18-3 GOOD 00000003
< GALILEO 12 LOCKEDOUT 00000000
< GALILEO 11 LOCKEDOUT 00000000
< BEIDOU 8 GOOD 00000003
```

| Field | Field type     | Description  | Format | Binary Bytes | Binary Offset |
|-------|----------------|--|--------|--------------|---------------|
| 1     | PSRSATS header | Log header. See <i>Messages</i> on page 25 for more information. |        | H            | 0             |
| 2     | #entries       | Number of records to follow                                      | Ulong  | 4            | H             |

| Field | Field type   | Description   | Format | Binary Bytes | Binary Offset       |
|-------|--|---|--------|--------------|---------------------|
| 3     | system   | See <i>Table 102: Satellite System</i> on page 532  | Enum   | 4            | H+4                 |
| 4     | Satellite ID   | Satellite identifier  | Ulong  | 4            | H+8                 |
| 5     | Status   | Satellite status (see <i>Table 79: Observation Statuses</i> on page 426)  | Enum   | 4            | H+12                |
| 6     | Signal mask  | See <i>Table 80: BESTSATS GPS Signal Mask</i> on page 427, <i>Table 81: BESTSATS GLONASS Signal Mask</i> on page 428, <i>Table 82: BESTSATS Galileo Signal Mask</i> on page 428, and <i>Table 83: BESTSATS BeiDou Signal Mask</i> on page 428 | Hex    | 4            | H+16                |
| 7     | Next satellite offset = $H+4+(\text{\#sat} \times 16)$ |   |        |              |                     |
| 8     | xxxx   | 32-bit CRC (ASCII and Binary only)  | Hex    | 4            | H+4+<br>(#sat x 16) |
| 9     | [CR][LF]   | Sentence terminator (ASCII only)  | -      | -            | -                   |

## 3.111 PSRVEL

### *Pseudorange velocity*

**Platform: OEM719, OEM729, OEM7500, OEM7700, OEM7720, PwrPak7, HxGN PIM7500**

In the PSRVEL log the actual speed and direction of the receiver antenna over ground is provided. The velocity measurements sometimes have a latency associated with them. The time of validity is the time tag in the log minus the latency value.



In a PSRVEL log, the actual speed and direction of the receiver antenna over ground is provided. The receiver does not determine the direction a vessel, craft or vehicle is pointed (heading) but rather the direction of motion of the GNSS antenna relative to ground.

The velocity in the PSRVEL log is determined by the pseudorange filter. Velocities from the pseudorange filter are calculated from the Doppler.

The velocity status indicates varying degrees of velocity quality. To ensure healthy velocity, the velocity sol-status must also be checked. If the sol-status is non-zero, the velocity is likely invalid. It should be noted that the receiver does not determine the direction a vessel, craft, or vehicle is pointed (heading), but rather the direction of the motion of the GPS antenna relative to the ground.

The latency of the instantaneous Doppler velocity is always 0.15 seconds. The latency represents an estimate of the delay caused by the tracking loops under acceleration of approximately 1 G. For most users, the latency can be assumed to be zero (instantaneous velocity).

**Message ID: 100**

**Log Type: Synch**

**Recommended Input:**

```
log psrvela ontime 1
```

**ASCII Example:**

```
#PSRVELA,COM1,0,52.5,FINESTEERING,1337,403362.000,02000000,658b,1984;S  
OL_COMPUTED,PSRDIFF,0.250,9.000,0.0698,26.582692,0.0172,0.0*a94e5d48
```



Consider the case where vehicles are leaving a control center. The control center's coordinates are known but the vehicles are on the move. Using the control center's position as a reference, the vehicles are able to report where they are with PSRPOS and their speed and direction with PSRVEL at any time.

| Field | Field type    | Description   | Format | Binary Bytes | Binary Offset |
|-------|---------------|---|--------|--------------|---------------|
| 1     | PSRVEL header | Log header. See <i>Messages</i> on page 25 for more information.  |        | H            | 0             |
| 2     | sol status    | Solution status, see <i>Table 73: Solution Status</i> on page 419   | Enum   | 4            | H             |
| 3     | vel type      | Velocity type, see <i>Table 74: Position or Velocity Type</i> on page 420   | Enum   | 4            | H+4           |
| 4     | latency       | A measure of the latency in the velocity time tag in seconds. It should be subtracted from the time to give improved results                          | Float  | 4            | H+8           |
| 5     | age           | Differential age in seconds   | Float  | 4            | H+12          |
| 6     | hor spd       | Horizontal speed over ground, in metres per second  | Double | 8            | H+16          |
| 7     | trk gnd       | Actual direction of motion over ground (track over ground) with respect to True North, in degrees   | Double | 8            | H+24          |
| 8     | vert spd      | Vertical speed, in metres per second, where positive values indicate increasing altitude (up) and negative values indicate decreasing altitude (down) | Double | 8            | H+32          |
| 9     | Reserved      |   | Float  | 4            | H+40          |
| 10    | xxxx          | 32-bit CRC (ASCII and Binary only)  | Ulong  | 4            | H+44          |
| 11    | [CR]<br>[LF]  | Sentence terminator (ASCII only)  | -      | -            | -             |

## 3.112 PSRXYZ

### *Pseudorange Cartesian position and velocity*

**Platform: OEM719, OEM729, OEM7500, OEM7700, OEM7720, PwrPak7, HxGN PIM7500**

This log contains the receiver's pseudorange position and velocity in ECEF coordinates. The position and velocity status field's indicate whether or not the corresponding data is valid. See *Figure 11: The WGS84 ECEF Coordinate System* on page 437 for a definition of the ECEF coordinates.

The velocity status indicates varying degrees of velocity quality. To ensure healthy velocity, the velocity sol-status must also be checked. If the sol-status is non-zero, the velocity is likely invalid. It should be noted that the receiver does not determine the direction a vessel, craft or vehicle is pointed (heading) but rather the direction of the motion of the GNSS antenna relative to the ground.

The latency of the instantaneous Doppler velocity is always 0.15 seconds. The latency represents an estimate of the delay caused by the tracking loops under acceleration of approximately 1 G. For most users, the latency can be assumed to be zero (instantaneous velocity).

**Message ID: 243**

**Log Type: Synch**

**Recommended Input:**

```
log psrxyza ontime 1
```

**ASCII Example:**

```
#PSRXYZA,COM1,0,58.5,FINESTEERING,1419,340038.000,02000040,4a28,2724;S
OL_COMPUTED,SINGLE,-1634530.7002,-
3664617.2823,4942495.5175,1.7971,2.3694,2.7582,SOL_COMPUTED,DOPPLER_
VELOCITY,0.0028,0.0231,-
0.0120,0.2148,0.2832,0.3297,"",0.150,0.000,0.000,12,12,0,0,0,06,0,33*4
fdbcdb1
```



The instantaneous Doppler is the measured Doppler frequency which consists of the satellite's motion relative to the receiver (Satellite Doppler + User Doppler) and the clock (local oscillator) drift.

| Field | Field type    | Description   | Format | Binary Bytes | Binary Offset |
|-------|---------------|---|--------|--------------|---------------|
| 1     | PSRXYZ header | Log header. See <i>Messages</i> on page 25 for more information.  |        | H            | 0             |
| 2     | P-sol status  | Solution status, see <i>Table 73: Solution Status</i> on page 419 | Enum   | 4            | H             |



| Field | Field type   | Description  | Format  | Binary Bytes | Binary Offset |
|-------|--------------|--|---------|--------------|---------------|
| 3     | pos type     | Position type, see <i>Table 74: Position or Velocity Type</i> on page 420  | Enum    | 4            | H+4           |
| 4     | P-X          | Position X-coordinate (m)  | Double  | 8            | H+8           |
| 5     | P-Y          | Position Y-coordinate (m)  | Double  | 8            | H+16          |
| 6     | P-Z          | Position Z-coordinate (m)  | Double  | 8            | H+24          |
| 7     | P-X $\sigma$ | Standard deviation of P-X (m)  | Float   | 4            | H+32          |
| 8     | P-Y $\sigma$ | Standard deviation of P-Y (m)  | Float   | 4            | H+36          |
| 9     | P-Z $\sigma$ | Standard deviation of P-Z (m)  | Float   | 4            | H+40          |
| 10    | V-sol status | Solution status, see <i>Table 73: Solution Status</i> on page 419  | Enum    | 4            | H+44          |
| 11    | vel type     | Velocity type, see <i>Table 74: Position or Velocity Type</i> on page 420  | Enum    | 4            | H+48          |
| 12    | V-X          | Velocity vector along X-axis (m/s)   | Double  | 8            | H+52          |
| 13    | V-Y          | Velocity vector along Y-axis (m/s)   | Double  | 8            | H+60          |
| 14    | V-Z          | Velocity vector along Z-axis (m/s)   | Double  | 8            | H+68          |
| 15    | V-X $\sigma$ | Standard deviation of V-X (m/s)  | Float   | 4            | H+76          |
| 16    | V-Y $\sigma$ | Standard deviation of V-Y (m/s)  | Float   | 4            | H+80          |
| 17    | V-Z $\sigma$ | Standard deviation of V-Z (m/s)  | Float   | 4            | H+84          |
| 18    | stn ID       | Base station ID  | Char[4] | 4            | H+88          |
| 19    | V-latency    | A measure of the latency in the velocity time tag in seconds. It should be subtracted from the time to give improved results | Float   | 4            | H+92          |
| 20    | diff_age     | Differential age in seconds  | Float   | 4            | H+96          |
| 21    | sol_age      | Solution age in seconds  | Float   | 4            | H+100         |
| 22    | #SVs         | Number of satellites tracked   | Uchar   | 1            | H+104         |
| 23    | #solnSVs     | Number of satellite vehicles used in solution  | Uchar   | 1            | H+105         |
| 24    | Reserved     |  | Char    | 1            | H+106         |
| 25    |              |  | Char    | 1            | H+107         |
| 26    |              |  | Char    | 1            | H+108         |

| Field | Field type                  | Description   | Format | Binary Bytes | Binary Offset |
|-------|-----------------------------|---|--------|--------------|---------------|
| 27    | ext sol stat                | Extended solution status (see <i>Table 77: Extended Solution Status</i> on page 423)                        | Hex    | 1            | H+109         |
| 28    | Galileo and BeiDou sig mask | Galileo and BeiDou signals used mask (see <i>Table 76: Galileo and BeiDou Signal-Used Mask</i> on page 423) | Hex    | 1            | H+110         |
| 29    | GPS and GLONASS sig mask    | GPS and GLONASS signals used mask (see <i>Table 75: GPS and GLONASS Signal-Used Mask</i> on page 422)       | Hex    | 1            | H+111         |
| 30    | xxxx                        | 32-bit CRC (ASCII and Binary only)  | Hex    | 4            | H+112         |
| 31    | [CR][LF]                    | Sentence terminator (ASCII only)  | -      | -            | -             |

### 3.113 QZSSALMANAC

#### *Decoded QZSS Almanac parameters*

**Platform: OEM719, OEM729, OEM7500, OEM7700, OEM7720, PwrPak7, HxGN PIM7500**

This log contains the decoded almanac parameters as received from the satellite with the parity information removed and appropriate scaling applied.

The OEM7 family of receivers automatically save almanacs in their Non-Volatile Memory (NVM), so creating an almanac boot file is not necessary.



For more information about QZSS almanac data, refer to the Interface Specifications for QZSS at [http://qz-vision.jaxa.jp/USE/is-qzss/index\\_e.html](http://qz-vision.jaxa.jp/USE/is-qzss/index_e.html).

**Message ID: 1346**

**Log Type: Asynch**

**Recommended Input:**

```
log qzssalmanaca onchanged
```

**ASCII Example:**

```
#QZSSALMANACA,COM1,0,89.5,SATTIME,1642,148584.000,02000008,67d2,39655;
1,
193,1642,208896.0,7.587582e-02,-2.94869425e-09,-1.4441238e+00,
-1.5737385e+00,1.7932513e+00,0.00000000,0.00000000,7.29336435e-05,
4.2159360e+07,7.11809030e-01,7,7*fb648921
```



The speed at which the receiver locates and locks onto new satellites is improved if the receiver has approximate time and position, as well as an almanac. This allows the receiver to compute the elevation of each satellite so it can tell which satellites are visible and their Doppler offsets, improving Time to First Fix (TTFF).

| Field | Field Type         | Description   | Format | Binary Bytes | Binary Offset |
|-------|--------------------|---|--------|--------------|---------------|
| 1     | QZSSALMANAC Header | Log header. See <i>Messages</i> on page 25 for more information.                                |        | H            | 0             |
| 2     | #messages          | Number of satellite PRN almanac messages to follow. Set to zero until almanac data is available | Ulong  | 4            | H             |
| 3     | PRN                | Satellite PRN number for current message (dimensionless)  | Ulong  | 4            | H+4           |

| Field | Field Type                              | Description   | Format | Binary Bytes | Binary Offset                |
|-------|---|---|--------|--------------|------------------------------|
| 4     | week                                    | Almanac reference week  | Ulong  | 4            | H+8                          |
| 5     | seconds                                 | Almanac reference time (s)  | Double | 8            | H+12                         |
| 6     | ecc                                     | Eccentricity (dimensionless) defined for a conic section where<br>e = 0 is a circle,<br>e = 1 is a parabola,<br>0 < e < 1 is an ellipse<br>e > 1 is a hyperbola                 | Double | 8            | H+20                         |
| 7     | $\dot{\omega}$                          | Rate of right ascension (radians/s)   | Double | 8            | H+28                         |
| 8     | $\omega_0$                              | Right, ascension (radians)  | Double | 8            | H+36                         |
| 9     | $\omega$                                | Argument of perigee (radians) measurement along the orbital path from the ascending node to the point where the SV is closest to the Earth, in the direction of the SV's motion | Double | 8            | H+44                         |
| 10    | $M_0$                                   | Mean anomaly of reference time (radians)  | Double | 8            | H+52                         |
| 11    | $a_{f0}$                                | Clock aging parameter (s)   | Double | 8            | H+60                         |
| 12    | $a_{f1}$                                | Clock aging parameter (s/s)   | Double | 8            | H+68                         |
| 13    | N                                       | Corrected mean motion (radians/s)   | Double | 8            | H+76                         |
| 14    | A                                       | Semi-major axis (m)   | Double | 8            | H+84                         |
| 15    | inclination angle                       | Angle of inclination  | Double | 8            | H+92                         |
| 16    | health-prn                              | SV health from Page 25 of subframe 4 or 5 (6 bits)  | Ulong  | 4            | H+100                        |
| 17    | health-alm                              | SV health from almanac (8 bits)   | Ulong  | 4            | H+104                        |
| 18    | Next PRN offset = H+4+(#messages x 104) |   |        |              |                              |
| 19    | xxxx                                    | 32-bit CRC (ASCII and Binary only)  | Ulong  | 4            | H+4+<br>(#messages<br>x 104) |
| 20    | [CR][LF]                                | Sentence terminator (ASCII only)  | -      | -            | -                            |

## 3.114 QZSSEPHMERIS

### *Decoded QZSS parameters*

**Platform: OEM719, OEM729, OEM7500, OEM7700, OEM7720, PwrPak7, HxGN PIM7500**

This log contains a single set of QZSS ephemeris parameters.

**Message ID: 1336**

**Log Type: Asynch**

**Recommended Input:**

```
log qzssephemerisa onchanged
```

**ASCII Example:**

```
#QZSSEPHMERISA,COM1,0,93.5,SATTIME,1642,153690.000,02000008,1e9d,
39655;193,153690.000000000,7,201,201,1642,1642,154800.000000000,
4.216030971806980e+07,2.115802417e-09,-2.152109479,0.075863329,
-1.573817810,-0.000007546,0.000009645,-177.375000000,-219.875000000,
-0.000000797,-0.000002151,0.711859299,-2.978695503e-10,-1.443966112,
-1.636139580e-09,713,154800.000000000,-5.122274160e-09,-0.000000163,
1.250555215e-12,0.000000000,FALSE,0.000072933,4.000000000,0,0,0,0
*fbb52c7f
```

| Field | Field Type          | Description   | Format | Binary Bytes | Binary Offset |
|-------|---------------------|---|--------|--------------|---------------|
| 1     | QZSSEPHMERIS header | Log header. See <i>Messages</i> on page 25 for more information.  |        | H            | 0             |
| 2     | PRN                 | Satellite PRN number  | Ulong  | 4            | H             |
| 3     | tow                 | Time stamp of subframe 0 (s)  | Double | 8            | H+4           |
| 4     | health              | Health status - a 6-bit health code as defined in QZSS Interface Specification  | Ulong  | 4            | H+12          |
| 5     | IODE1               | Issue of ephemeris data 1   | Ulong  | 4            | H+16          |
| 6     | IODE2               | Issue of ephemeris data 2   | Ulong  | 4            | H+20          |
| 7     | week                | GPS reference week number   | Ulong  | 4            | H+24          |
| 8     | z week              | Z count week number. This is the week number from subframe 1 of the ephemeris. The 'toe week' (field #7) is derived from this to account for rollover | Ulong  | 4            | H+28          |
| 9     | toe                 | Reference time for ephemeris (s)  | Double | 8            | H+32          |

| Field | Field Type     | Description   | Format | Binary Bytes | Binary Offset |
|-------|----------------|---|--------|--------------|---------------|
| 10    | A              | Semi-major axis (m)   | Double | 8            | H+40          |
| 11    | $\Delta N$     | Mean motion difference (radians/s)  | Double | 8            | H+48          |
| 12    | $M_0$          | Mean anomaly of reference time (radius)   | Double | 8            | H+56          |
| 13    | ecc            | Eccentricity (dimensionless) quantity defined for a conic section where<br>e = 0 is a circle,<br>e = 1 is a parabola,<br>0 < e < 1 is an ellipse<br>e > 1 is a hyperbola        | Double | 8            | H+64          |
| 14    | $\omega$       | Argument of perigee (radians) measurement along the orbital path from the ascending node to the point where the SV is closest to the Earth, in the direction of the SV's motion | Double | 8            | H+72          |
| 15    | cuc            | Argument of latitude (amplitude of cosine, radians)   | Double | 8            | H+80          |
| 16    | cus            | Argument of latitude (amplitude of sine, radians)   | Double | 8            | H+88          |
| 17    | crc            | Orbit radius (amplitude of cosine, metres)  | Double | 8            | H+96          |
| 18    | crs            | Orbit radius (amplitude of sine, metres)  | Double | 8            | H+104         |
| 19    | cic            | Inclination (amplitude of cosine, radians)  | Double | 8            | H+112         |
| 20    | cis            | Inclination (amplitude of sine, radians)  | Double | 8            | H+120         |
| 21    | $I_0$          | Inclination angle at reference time (radians)   | Double | 8            | H+128         |
| 22    | $\dot{I}$      | Rate of inclination angle (radians/s)   | Double | 8            | H+136         |
| 23    | $\omega_0$     | Right ascension (radians)   | Double | 8            | H+144         |
| 24    | $\dot{\omega}$ | Rate of right ascension (radians/s)   | Double | 8            | H+152         |
| 25    | iodc           | Issue of data clock   | Ulong  | 4            | H+160         |
| 26    | toc            | SV clock correction term (s)  | Double | 8            | H+164         |
| 27    | tgd            | Estimated group delay difference (s)  | Double | 8            | H+172         |
| 28    | $a_{f_0}$      | Clock aging parameter (s)   | Double | 8            | H+180         |

| Field | Field Type   | Description   | Format | Binary Bytes | Binary Offset |
|-------|--------------|---|--------|--------------|---------------|
| 29    | $a_{f1}$     | Clock aging parameter (s/s)   | Double | 8            | H+188         |
| 30    | $a_{f2}$     | Clock aging parameter (s/s/s)   | Double | 8            | H+196         |
| 31    | AS           | Anti-spoofing on:<br>0= FALSE<br>1=TRUE   | Enum   | 4            | H+204         |
| 32    | N            | Corrected mean motion (radians/s)   | Double | 8            | H+208         |
| 33    | URA          | User Range Accuracy variance, m2. The ICD specifies that the URA index transmitted in the ephemerides can be converted to a nominal standard deviation value using an algorithm listed there. We publish the square of the nominal value (variance) | Double | 8            | H+216         |
| 34    | Fit Interval | Curve fit interval:<br>0 = Ephemeris data are effective for 2 hours<br>1 = Ephemeris data are effective for more than 2 hours   | Uchar  | 1            | H+224         |
| 35    | Reserved     |   | Uchar  | 1            | H+225         |
| 36    | Reserved     |   | Uchar  | 1            | H+226         |
| 37    | Reserved     |   | Uchar  | 1            | H+227         |
| 38    | xxxx         | 32-bit CRC (ASCII and Binary only)  | Ulong  | 4            | H+228         |
| 39    | [CR][LF]     | Sentence terminator (ASCII only)  | -      | -            | -             |

## 3.115 QZSSIONUTC

### *QZSS ionospheric and time information*

**Platform: OEM719, OEM729, OEM7500, OEM7700, OEM7720, PwrPak7, HxGN PIM7500**

This log contains the Ionospheric Model parameters (ION) and the Universal Time Coordinated parameters (UTC) for QZSS.

**Message ID: 1347**

**Log Type: Asynch**

**Recommended Input:**

```
log qzssionutca onchanged
```

**ASCII Example:**

```
#QZSSIONUTC,COM1,0,94.0,FINESTEERING,1642,153300.565,02480008,158b,
39655;1.396983861923218e-08,-6.705522537231444e-8,
0.000000000000000e+000,1.788139343261719e-07,8.396800000000000e+04,
7.536640000000000e+05,-7.864320000000000e+05,-6.946816000000000e+06,
1642,307200,-5.5879354476928711e-09,5.329070518e-15,1768,4,15,15,0
*0204eec1
```

| Field | Field Type        | Description  | Format | Binary Bytes | Binary Offset |
|-------|-------------------|--|--------|--------------|---------------|
| 1     | QZSSIONUTC Header | Log header. See <i>Messages</i> on page 25 for more information. |        | H            | 0             |
| 2     | a0                | Alpha parameter constant term                                    | Double | 8            | H             |
| 3     | a1                | Alpha parameter 1st order term                                   | Double | 8            | H+8           |
| 4     | a2                | Alpha parameter 2nd order term                                   | Double | 8            | H+16          |
| 5     | a3                | Alpha parameter 3rd order term                                   | Double | 8            | H+24          |
| 6     | b0                | Beta parameter constant term                                     | Double | 8            | H+32          |
| 7     | b1                | Beta parameter 1st order term                                    | Double | 8            | H+40          |
| 8     | b2                | Beta parameter 2nd order term                                    | Double | 8            | H+48          |
| 9     | b3                | Beta parameter 3rd order term                                    | Double | 8            | H+56          |
| 10    | utc wn            | UTC reference week number  | Ulong  | 4            | H+64          |
| 11    | tot               | Reference time of UTC parameters                                 | Ulong  | 4            | H+68          |
| 12    | A0                | UTC constant term of polynomial                                  | Double | 8            | H+72          |



| Field | Field Type | Description   | Format | Binary Bytes | Binary Offset |
|-------|------------|---|--------|--------------|---------------|
| 13    | A1         | UTC 1st order term of polynomial                                  | Double | 8            | H+80          |
| 14    | wn lsf     | Future week number  | Ulong  | 4            | H+88          |
| 15    | dn         | Day number<br>(the range is 1 to 7 where Sunday=1 and Saturday=7) | Ulong  | 4            | H+92          |
| 16    | deltat ls  | Delta time due to leap seconds                                    | Long   | 4            | H+96          |
| 17    | deltat lsf | Future delta time due to leap seconds                             | Long   | 4            | H+100         |
| 18    | Reserved   |   |        | 4            | H+104         |
| 19    | xxxx       | 32-bit CRC (ASCII and Binary only)                                | Ulong  | 4            | H+108         |
| 20    | [CR][LF]   | Sentence terminator (ASCII only)                                  | -      | -            | -             |

## 3.116 QZSSRAWALMANAC

### *Raw QZSS almanac data*

**Platform: OEM719, OEM729, OEM7500, OEM7700, OEM7720, PwrPak7, HxGN PIM7500**

This log contains the undecoded almanac subframes as received from the QZSS satellite.

**Message ID: 1345**

**Log Type: Asynch**

**Recommended Input:**

```
log qzssrawalmanaca onchanged
```

**ASCII Example:**

```
#QZSSRAWALMANACA, COM1, 0, 93.5, SATTIME, 1642, 153300.000, 02480008, 64c4, 396
55;1642,
208896.000, 7,
1, 8b000031c390c1820e33d007fefef07cae831c5293ebfe15049104a000001,
51, 8b000031c613f3336a1ffffffffffffffffffffffffffffffffffffffff000000,
49, 8b000031cd90f14e6a7cf3cf1cf1cf3cf3c73cf1cf1cf3cf3cf3cf000002,
50, 8b000031ce14f24e6a0cf3cf1df1cffffffffffffffffffffffffffffffff000002,
56, 8b000031d511f80ff70003292ef496000006fffffffffa4b6a0fe8040f0002,
52, 8b000031e692f4a00a0fff83f060f2080180082082082082082002080381,
53, 8b000031e717f58082082082082082082082082082082082082082080
*ca4596f9l
```



The OEM7 family of receivers automatically saves almanacs in their Non-Volatile Memory (NVM), therefore creating an almanac boot file is not necessary.

| Field | Field Type             | Description   | Format | Binary Bytes | Binary Offset |
|-------|------------------------|---|--------|--------------|---------------|
| 1     | QZSSRAW ALMANAC header | Log header. See <i>Messages</i> on page 25 for more information.              |        | H            | 0             |
| 2     | ref week               | Almanac reference week number   | Ulong  | 4            | H             |
| 3     | ref secs               | Almanac reference time, in milliseconds (binary data) or seconds (ASCII data) | GPSec  | 4            | H+4           |
| 4     | #subframes             | Number of subframes to follow   | Ulong  | 4            | H+8           |

| Field | Field Type                                   | Description  | Format | Binary Bytes | Binary Offset                 |
|-------|--|--|--------|--------------|-------------------------------|
| 5     | svid   | SV ID (satellite vehicle ID)<br>A value between 1 and 32 for the SV ID indicates the PRN of the satellite. Any other values indicate the page ID.<br>SV ID 1 to 10 corresponds to QZSS PRN 193 to 202. Refer to QZSS Interface Specification for more details. | Hex    | 2            | H+12                          |
| 6     | data   | Subframe page data   | Hex    | 30           | H+14                          |
| 7     | Next subframe offset = H+12+(#subframe x 32) |  |        |              |                               |
| 8     | xxxx   | 32-bit CRC (ASCII and Binary only)   | Hex    | 4            | H+12+<br>(#subframes<br>x 32) |
| 9     | [CR][LF]                                     | Sentence terminator (ASCII only)   | -      | -            | -                             |

## 3.117 QZSSRAWCNAVMESSAGE

### Raw QZSS L2C and L5 CNAV message

**Platform: OEM719, OEM729, OEM7500, OEM7700, OEM7720, PwrPak7, HxGN PIM7500**

This log provides the raw QZSS L2C and L5 CNAV message.



The QZSSRAWCNAVMESSAGE log is not output by default. To receive this log, data decoding for QZSSL2C or QZSSL5 must be enabled using the **DATADECODESIGNAL** command (see page 111) for the specific signal.

**Message ID: 1530**

**Log Type: Collection**

**Recommended Input:**

```
log qzssrawcnavmessage onnew
```

**ASCII Example:**

```
#QZSSRAWCNAVMESSAGEA,COM1,0,66.5,SATTIME,1902,405696.000,02000020,20f7,13677;40,193,10,8b04a84110edc2a346a97d311c3ff854620220004eba94f1313134f005530056c9da0ccc2300*1f2abac5
```

| Field | Field type                | Description  | Format  | Binary Bytes | Binary Offset |
|-------|---------------------------|--|---------|--------------|---------------|
| 1     | QZSSRAWCNAVMESSAGE header | Log header. See <i>Messages</i> on page 25 for more information. | -       | H            | 0             |
| 2     | sigchannum                | Signal channel providing the bits                                | Ulong   | 4            | H             |
| 3     | PRN                       | QZSS satellite PRN number  | Ulong   | 4            | H+4           |
| 4     | messageId                 | CNAV message ID  | Ulong   | 4            | H+8           |
| 5     | data                      | CNAV raw message data  | Hex[38] | 38           | H+12          |
| 6     | xxxx                      | 32-bit CRC (ASCII and Binary only)                               | Hex     | 4            | H+50          |
| 7     | [CR][LF]                  | Sentence terminator (ASCII only)                                 | -       | -            | -             |

## 3.118 QZSSRAWEPHEM

### *QZSS Raw ephemeris information*

**Platform:** OEM719, OEM729, OEM7500, OEM7700, OEM7720, PwrPak7, HxGN PIM7500

This log contains the raw binary information for subframes one, two and three from the satellite with the parity information removed. Each subframe is 240 bits long (10 words - 24 bits each) and the log contains a total 720 bits (90 bytes) of information (240 bits x 3 subframes). This information is preceded by the PRN number of the satellite from which it originated. This message is not generated unless all 10 words from all 3 frames have passed parity.

**Message ID: 1331**

**Log Type: Asynch**

**Recommended Input:**

```
log qzssrawephema onnew
```

**ASCII Example:**

```
#QZSSRAWEPHEMA, COM1, 0, 84.5, SATTIME, 1642, 230580.000, 02000008, 2f9e, 39655;
193, 1642, 234000, 8b00004b0f879aa01c80000000000000000000000f6df3921fe0005
fffdbd, 8b00004b1009dfd2bb1ec493a98277e8fd26d924d5062dcae8f5b739210e, 8b
00004b108ffe5bc52864ae00591d003b8b02b6bfe13f3afffe2afdf1e7*d2bd151e
```

| Field | Field Type          | Description  | Format | Binary Bytes | Binary Offset |
|-------|---------------------|--|--------|--------------|---------------|
| 1     | QZSSRAWEPHEM header | Log header. See <i>Messages</i> on page 25 for more information. |        | H            | 0             |
| 2     | prn                 | Satellite PRN number   | Ulong  | 4            | H             |
| 3     | ref week            | Ephemeris reference week number                                  | Ulong  | 4            | H+4           |
| 4     | ref secs            | Ephemeris reference time (s)                                     | Ulong  | 4            | H+8           |
| 5     | subframe1           | Subframe 1 data  | Hex    | 30           | H+12          |
| 6     | subframe2           | Subframe 2 data  | Hex    | 30           | H+42          |
| 7     | subframe3           | Subframe 3 data  | Hex    | 30           | H+72          |
| 8     | xxxx                | 32-bit CRC (ASCII and Binary only)                               | Ulong  | 4            | H+102         |
| 9     | [CR][LF]            | Sentence terminator (ASCII only)                                 | -      | -            | -             |

## 3.119 QZSSRAWSUBFRAME

### *Raw QZSS subframe data*

**Platform: OEM719, OEM729, OEM7500, OEM7700, OEM7720, PwrPak7, HxGN PIM7500**

This log contains the raw QZSS subframe data.

A raw QZSS subframe is 300 bits in total, 10 words of 30 bits each. This includes the parity 6 bits at the end of each word, for a total of 60 parity bits. Note that in Field #4, the 'data' field below, the 60 parity bits are stripped out and only the raw subframe data remains, for a total of 240 bits. There are two bytes added onto the end of this 30 byte packed binary array to pad out the entire data structure to 32 bytes in order to maintain 4 byte alignment.

**Message ID: 1330**

**Log Type: Asynch**

**Recommended Input:**

```
log qzssrawsubframea onnew
```

**ASCII Example:**

```
#QZSSRAWSUBFRAMEA, COM1, 0, 85.5, SATTIME, 1642, 230604.000, 02000008, e56b, 39  
655;193, 5, 8b00004b11970637984efbf7fd4d0fa10ca49631ace140740a08fe0dfd43  
, 65*6a7b9123
```

| Field | Field Type              | Description  | Format   | Binary Bytes    | Binary Offset |
|-------|-------------------------|--|----------|-----------------|---------------|
| 1     | QZSSRAW SUBFRAME header | Log header. See <i>Messages</i> on page 25 for more information. |          | H               | 0             |
| 2     | PRN                     | Satellite PRN number   | Ulong    | 4               | H             |
| 3     | subfr id                | Subframe ID  | Ulong    | 4               | H+4           |
| 4     | data                    | Raw subframe data  | Hex [30] | 32 <sup>a</sup> | H+8           |
| 5     | chan                    | Signal channel number that the frame was decoded on              | Ulong    | 4               | H+40          |
| 6     | xxxx                    | 32-bit CRC (ASCII and Binary only)                               | Ulong    | 4               | H+44          |
| 7     | [CR][LF]                | Sentence terminator  | -        | -               | -             |

<sup>a</sup>In the binary log case, an additional 2 bytes of padding are added to maintain 4-byte alignment.

## 3.120 RAIMSTATUS

### *RAIM status*

**Platform: OEM719, OEM729, OEM7500, OEM7700, OEM7720, PwrPak7, HxGN PIM7500**

This log provides information on Receiver Autonomous Integrity Monitoring (RAIM) status (refer to the **RAIMMODE** command on page 284).

**Message ID: 1286**

**Log Type: Synch**

**Recommended Input:**

```
log raimstatusa ontime 1
```

**ASCII Example:**

```
#RAIMSTATUSA,COM1,0,88.5,FINESTEERING,1837,268443.500,02040008,bf2d,32768;DEFAULT,PASS,NOT_AVAILABLE,0.000,NOT_AVAILABLE,0.000,1,GLONASS,10-7*6504be7b
```

| Field | Field Type        | Description   | Format | Binary Bytes | Binary Offset |
|-------|-------------------|---|--------|--------------|---------------|
| 1     | RAIMSTATUS Header | Log header. See <i>Messages</i> on page 25 for more information.                                    | -      | H            | 0             |
| 2     | RAIM Mode         | RAIM mode (refer to <i>Table 54: RAIM Mode Types</i> on page 285)                                   | Enum   | 4            | H             |
| 3     | Integrity status  | Integrity Status (see <i>Table 121: Integrity Status</i> on the next page)                          | Enum   | 4            | H+4           |
| 4     | HPL status        | Horizontal protection level status (see <i>Table 122: Protection Level Status</i> on the next page) | Enum   | 4            | H+8           |
| 5     | HPL               | Horizontal protection level (m)   | Double | 8            | H+12          |
| 6     | VPL status        | Vertical protection level status (see <i>Table 122: Protection Level Status</i> on the next page)   | Enum   | 4            | H+20          |
| 7     | VPL               | Vertical protection level (m)   | Double | 8            | H+24          |
| 8     | #SVs              | Number of excluded satellites   | Ulong  | 4            | H+32          |
| 9     | System            | Satellite system (see <i>Table 102: Satellite System</i> on page 532)                               | Enum   | 4            | H+36          |

| Field | Field Type                          | Description   | Format | Binary Bytes | Binary Offset     |
|-------|-------------------------------------|---|--------|--------------|-------------------|
| 10    | Satellite ID                        | In binary logs, the satellite ID field is 4 bytes. The 2 lowest order bytes, interpreted as a USHORT, are the system identifier. For instance, the PRN for GPS or the slot for GLONASS. The 2 highest-order bytes are the frequency channel for GLONASS, interpreted as a SHORT and zero for all other systems.<br><br>In ASCII and abbreviated ASCII logs, the satellite ID field is the system identifier. If the system is GLONASS and the frequency channel is not zero, then the signed channel is appended to the system identifier. For example, slot 13, frequency channel -2 is output as 13-2 | Ulong  | 4            | H+40              |
| 11    | Next offset field = H+36+(#SVs * 8) |   |        |              |                   |
| 12    | xxxx                                | 32-bit CRC (ASCII and Binary only)  | Ulong  | 4            | H+36 + (#SVs * 8) |
| 13    | [CR][LF]                            | Sentence terminator (ASCII only)  |        |              |                   |

**Table 121: Integrity Status**

| Binary | ASCII         | Description  |
|--------|---------------|--|
| 0      | NOT_AVAILABLE | RAIM is unavailable because either there is no solution or because the solution is unique, that is, there is no redundancy |
| 1      | PASS          | RAIM succeeded. Either there were no bad observations or the bad observations were successfully removed from the solution  |
| 2      | FAIL          | RAIM detected a failure and was unable to isolate the bad observations   |

**Table 122: Protection Level Status**

| Binary | ASCII         | Description   |
|--------|---------------|---|
| 0      | NOT_AVAILABLE | When RAIM is not available for example, after issuing a <b>FRESET</b> command (see page 170) or when there are not enough satellites tracked to produce the required redundant observations |



| Binary | ASCII | Description  |
|--------|-------|--|
| 1      | PASS  | Current protection levels are below alert limits, meaning positioning accuracy requirements are fulfilled<br>HPL < HAL<br>VPL < VAL                      |
| 2      | ALERT | Current protection levels are above alert limits, meaning required positioning accuracy cannot be guaranteed by RAIM algorithm<br>HPL ≥ HAL<br>VPL ≥ VAL |

## 3.121 RANGE

### *Satellite range information*

**Platform: OEM719, OEM729, OEM7500, OEM7700, OEM7720, PwrPak7, HxGN PIM7500**

The RANGE log contains the channel measurements for the currently tracked satellites. When using this log, please keep in mind the constraints noted along with the description.

It is important to ensure that the receiver clock has been set. This can be monitored by the bits in the Receiver Status field of the log header. Large jumps in pseudorange as well as Accumulated Doppler Range (ADR) occur as the clock is being adjusted. If the ADR measurement is being used in precise phase processing, it is important not to use the ADR if the "parity known" flag, in the ch-tr-status field, is not set as there may exist a half (1/2) cycle ambiguity on the measurement. The tracking error estimate of the pseudorange and carrier phase (ADR) is the thermal noise of the receiver tracking loops only. It does not account for possible multipath errors or atmospheric delays.

If multiple signals are being tracked for a given PRN, an entry for each signal, with the same PRN, appears in the RANGE logs. As shown in *Table 123: Channel Tracking Status* on page 662, these entries can be differentiated by bits 21-25, which indicate the signal type of the observation.



For dual antenna receivers, a RANGE\_1 log can be requested to get RANGE data from the second antenna. As described in *Table 3: Binary Message Header Structure* on page 30, the message type indicates the log is from the second antenna. To request an ASCII log enter RANGEA\_1, and for a binary log enter RANGEB\_1.

**Message ID: 43**

**Log Type: Synch**

**Recommended Input:**

```
log rangea ontime 30
```

**Abbreviated ASCII Example:**

```
<RANGE COM1 0 82.0 FINESTEERING 1729 155076.000 02004000 5103 11465
46
31 0 24514687.250 0.064 -128825561.494675 0.010 3877.473 45.0 563.310
18109c04
31 0 24514688.765 0.096 -100383546.734328 0.010 3021.415 39.8 558.900
02309c0b
14 0 20345286.178 0.047 -106915249.491005 0.008 90.799 47.6 10283.130
08109c24
14 0 20345282.367 0.130 -83310588.842026 0.008 70.753 44.0 10276.900
01303c2b
22 0 20789170.556 0.038 -109247823.573628 0.007 -1421.169 49.4
15829.450 18109c44
22 0 20789164.279 0.138 -85128150.759123 0.007 -1107.404 43.6 15822.400
```

```
11303c4b
11 0 21977065.699 0.057 -115490261.964920 0.009 1235.428 46.0 5831.400
18109c64
11 0 21977062.220 0.201 -89992401.903056 0.011 962.671 40.3 5823.900
11303c6b
1 0 23109644.678 0.073 -121441999.794897 0.011 2971.250 43.8 3239.620
18109ca4
1 0 23109646.769 0.073 -94630142.467139 0.011 2315.261 42.1 3233.420
02309cab
1 0 23109647.385 0.009 -90687226.778371 0.009 2218.538 48.9 3237.080
01d03ca4
32 0 23839782.353 0.133 -125278916.608912 0.022 3033.561 38.7 2193.280
18109cc4
32 0 23839781.295 0.363 -97619939.025504 0.026 2363.815 35.1 2184.900
11303ccb
18 0 22923322.792 0.062 -120462840.747702 0.009 -2710.945 45.3
20493.260 18109d04
18 0 22923320.071 0.350 -93867119.471860 0.012 -2112.426 35.5 20484.400
11303d0b
24 0 23708761.188 0.111 -124590391.778428 0.015 -2376.459 40.2
10643.820 08109d24
24 0 23708763.572 0.065 -97083440.180816 0.015 -1851.788 43.1 10639.420
02309d2b
24 0 23708765.724 0.009 -93038305.697497 0.008 -1774.807 49.1 10641.680
01d03d24
19 0 23739234.067 0.078 -124750470.392697 0.013 -2778.561 43.3
12263.180 08109d64
19 0 23739230.131 0.250 -97208136.646475 0.014 -2165.115 38.4 12255.400
01303d6b
61 9 22189063.544 0.155 -118654856.801346 0.011 -3985.235 43.3
13310.882 08119e04
61 9 22189063.246 0.055 -92287085.024614 0.011 -3099.631 37.6 13303.964
00b13e0b
47 0 21209673.567 0.147 -113059527.680842 0.011 -804.710 43.8 7342.680
08119e24
47 0 21209679.575 0.043 -87935228.320976 0.011 -625.886 39.7 7334.968
00b13e2b
46 5 24097664.754 0.213 -128680178.570435 0.014 -3740.543 40.6
10098.600 08119e44
46 5 24097669.137 0.048 -100084595.729257 0.015 -2909.311 38.8
10082.838 10b13e4b
39 3 21484445.079 0.161 -114645140.076744 0.012 2864.162 43.0 4463.150
18119e64
39 3 21484447.532 0.046 -89168467.325722 0.013 2227.683 39.1 4453.468
10b13e6b
38 8 19445896.471 0.101 -103949483.524466 0.008 -389.973 47.1 11640.260
18119e84
38 8 19445897.101 0.048 -80849619.556577 0.009 -303.312 38.8 11632.974
00b13e8b
48 7 21301665.694 0.166 -113829687.684616 0.011 3143.656 42.8 3778.910
```

```

08119ea4
48 7 21301667.294 0.054 -88534230.502244 0.012 2445.068 37.8 3770.968
10b13eab
54 11 20899591.029 0.131 -111837944.708346 0.009 -401.734 44.8 7155.190
18119ec4
54 11 20899589.241 0.024 -86985062.942139 0.009 -312.461 44.8 7146.970
10b13ecb
55 4 23127316.661 0.318 -123455195.443877 0.020 3067.787 37.1 1588.420
18119ee4
55 4 23127321.850 0.032 -96020732.562183 0.021 2386.060 42.3 1580.442
00b13eeb
12 0 26239080.161 0.048 -137887256.553732 0.015 -2696.802 47.6
11527.710 48539c24
12 0 26239085.285 0.012 -102967750.707625 0.013 -2013.883 46.8
11523.770 41933c24
12 0 26239083.219 0.011 -105653860.401460 0.013 -2066.457 47.3
11523.712 42333c24
12 0 26239094.196 0.019 -104310841.607718 0.014 -2040.204 42.7
11522.970 42933c24
11 0 25589806.061 0.045 -134475330.397885 0.013 -729.686 48.0 4974.653
48539c64
11 0 25589809.285 0.010 -100419891.315177 0.012 -545.179 47.8 4969.770
41933c64
11 0 25589806.124 0.010 -103039536.069621 0.011 -559.405 48.0 4969.734
42333c64
11 0 25589818.004 0.017 -101729751.744395 0.013 -552.305 43.7 4967.060
42933c64
8 0 39844800.850 0.077 -207482308.002186 0.018 -507.335 37.4 12048.980
18149c84
8 0 39844800.076 0.043 -160438471.200694 0.013 -392.547 42.5 12038.660
00349c84

```

| Field | Field type   | Description   | Format | Binary Bytes | Binary Offset |
|-------|--------------|---|--------|--------------|---------------|
| 1     | RANGE header | Log header. See <i>Messages</i> on page 25 for more information.                        |        | H            | 0             |
| 2     | # obs        | Number of observations with information to follow <sup>1</sup>                          | Ulong  | 4            | H             |
| 3     | PRN/slot     | Satellite PRN number of range measurement<br>Refer to <i>PRN Numbers</i> on page 46     | Ushort | 2            | H+4           |
| 4     | glofreq      | (GLONASS Frequency + 7) (see GLONASS Slot and Frequency Numbers section of this manual) | Ushort | 2            | H+6           |

<sup>1</sup>Satellite PRNs may have multiple lines of observations, one for each signal tracked.

| Field    | Field type                                    | Description   | Format | Binary Bytes | Binary Offset          |
|----------|---|---|--------|--------------|------------------------|
| 5        | psr   | Pseudorange measurement (m)   | Double | 8            | H+8                    |
| 6        | psr $\sigma$                                  | Pseudorange measurement standard deviation (m)  | Float  | 4            | H+16                   |
| 7        | adr   | Carrier phase, in cycles (accumulated Doppler range)  | Double | 8            | H+20                   |
| 8        | adr $\sigma$                                  | Estimated carrier phase standard deviation (cycles)   | Float  | 4            | H+28                   |
| 9        | dopp  | Instantaneous carrier Doppler frequency (Hz)  | Float  | 4            | H+32                   |
| 10       | C/No  | Carrier to noise density ratio<br>$C/No = 10[\log_{10}(S/N_0)]$ (dB-Hz)   | Float  | 4            | H+36                   |
| 11       | locktime                                      | Number of seconds of continuous tracking (no cycle slipping)  | Float  | 4            | H+40                   |
| 12       | ch-tr-status                                  | Tracking status (see <i>Table 123: Channel Tracking Status</i> on the next page and the example in <i>Figure 14: Channel Tracking Example</i> on the next page) | Ulong  | 4            | H+44                   |
| 13...    | Next PRN offset = $H + 4 + (\#obs \times 44)$ |   |        |              |                        |
| variable | xxxx  | 32-bit CRC (ASCII and Binary only)  | Ulong  | 4            | H+4+<br>(#obs<br>x 44) |
| variable | [CR][LF]                                      | Sentence terminator (ASCII only)  | -      | -            | -                      |

**Figure 14: Channel Tracking Example**

| 0x     | N7                 |           |                             |                   | N6         |          |    |    | N5 |             |    |    | N4 |          |    |    | N3 |                  |    |    | N2 |                    |   |   | N1 |                  |   |   | N0 |             |   |   |  |                 |  |  |  |                    |  |  |  |                |  |  |  |
|--------|--------------------|-----------|-----------------------------|-------------------|------------|----------|----|----|----|-------------|----|----|----|----------|----|----|----|------------------|----|----|----|--------------------|---|---|----|------------------|---|---|----|-------------|---|---|--|-----------------|--|--|--|--------------------|--|--|--|----------------|--|--|--|
|        | 0                  |           |                             |                   | 8          |          |    |    | 1  |             |    |    | 0  |          |    |    | 9  |                  |    |    | C  |                    |   |   | 0  |                  |   |   | 4  |             |   |   |  |                 |  |  |  |                    |  |  |  |                |  |  |  |
| Bit    | 31                 | 30        | 29                          | 28                | 27         | 26       | 25 | 24 | 23 | 22          | 21 | 20 | 19 | 18       | 17 | 16 | 15 | 14               | 13 | 12 | 11 | 10                 | 9 | 8 | 7  | 6                | 5 | 4 | 3  | 2           | 1 | 0 |  |                 |  |  |  |                    |  |  |  |                |  |  |  |
| Binary | 0                  | 0         | 0                           | 0                 | 1          | 0        | 0  | 0  | 0  | 0           | 0  | 1  | 0  | 0        | 0  | 0  | 1  | 0                | 0  | 1  | 1  | 1                  | 1 | 0 | 0  | 0                | 0 | 0 | 0  | 0           | 1 | 0 |  |                 |  |  |  |                    |  |  |  |                |  |  |  |
| Data   | Channel Assignment | Lock Flag | Digital filtering on signal | Phase Measurement | Primary L1 | Reserved |    |    |    | Signal Type |    |    |    | Reserved |    |    |    | Satellite System |    |    |    | Correlator Spacing |   |   |    | Code Locked Flag |   |   |    | Parity Flag |   |   |  | Phase Lock Flag |  |  |  | Channel Number     |  |  |  | Tracking State |  |  |  |
| Value  | Automatic          | Lock Out  | No Digital Filter           | Half Cycle        | Primary    | L1 C/A   |    |    |    | Grouped     |    |    |    | GPS      |    |    |    | PAC              |    |    |    | Locked             |   |   |    | Known            |   |   |    | Locked      |   |   |  | Channel 0       |  |  |  | L1 Phase Lock Loop |  |  |  |                |  |  |  |

**Table 123: Channel Tracking Status**

| Nibble | Bit | Mask       | Description       | Range Value  |
|--------|-----|------------|-------------------|--|
| N0     | 0   | 0x00000001 | Tracking state    | 0-23,<br>see Table 124: Tracking State on page 664       |
|        | 1   | 0x00000002 |                   |  |
|        | 2   | 0x00000004 |                   |  |
|        | 3   | 0x00000008 |                   |  |
| N1     | 4   | 0x00000010 | SV channel number | (n-1) (0 = first, n = last)<br>n depends on the receiver |
|        | 5   | 0x00000020 |                   |  |
|        | 6   | 0x00000040 |                   |  |
|        | 7   | 0x00000080 |                   |  |
| N2     | 8   | 0x00000100 | Phase lock flag   | 0 = Not locked , 1 = Locked                              |
|        | 9   | 0x00000200 |                   |  |
|        | 10  | 0x00000400 | Parity known flag | 0 = Not known, 1 = Known                                 |
|        | 11  | 0x00000800 |                   |  |

| Nibble | Bit | Mask       | Description  | Range Value   |            |
|--------|-----|------------|--|---|------------|
| N3     | 12  | 0x00001000 | Code locked flag                                     | 0 = Not locked, 1 = Locked  |            |
|        | 13  | 0x00002000 | Correlator type                                      | 0-7,<br>see <i>Table 125: Correlator Type</i> on the next page  |            |
|        | 14  | 0x00004000 |  |   |            |
|        | 15  | 0x00008000 |  |   |            |
| N4     | 16  | 0x00010000 | Satellite system                                     | 0 = GPS   | 4 = BeiDou |
|        | 17  | 0x00020000 |  | 1 = GLONASS   | 5 = QZSS   |
|        | 18  | 0x00040000 |  | 2 = SBAS  | 6 = NavIC  |
|        | 19  | 0x00080000 | 3 = Galileo  | 7 = Other   |            |
| N5     | 20  | 0x00100000 | Grouping   | 0 = Not grouped, 1 = Grouped  |            |
|        | 21  | 0x00200000 | Signal type<br>(Dependent on satellite system above) | <p><u>GPS:</u><br/>0 = L1C/A<br/>5 = L2P<br/>9 = L2P (Y), semi-codeless<br/>14 = L5 (Q)<br/>16 = L1C (P)<br/>17 = L2C (M)</p> <p><u>GLONASS:</u><br/>0 = L1C/A<br/>1 = L2C/A<br/>5 = L2P<br/>6 = L3 (Q)</p> <p><u>BeiDou:</u><br/>0 = B1 (I) with D1 data<br/>1 = B2 (I) with D1 data<br/>2 = B3 (I) with D1 data<br/>4 = B1 (I) with D2 data<br/>5 = B2 (I) with D2 data<br/>6 = B3 (I) with D2 data</p> <p><u>Galileo:</u><br/>2 = E1 (C)<br/>12 = E5a (Q)<br/>17 = E5b (Q)<br/>20 = E5AltBOC (Q)</p> <p><u>QZSS:</u><br/>0 = L1C/A<br/>14 = L5 (Q)<br/>16 = L1C (P)<br/>17 = L2C (M)<br/>27 = L6 (L)</p> <p><u>SBAS:</u><br/>0 = L1C/A<br/>6 = L5 (I)</p> <p><u>NavIC:</u><br/>0 = L5 SPS</p> <p><u>Other:</u><br/>19 = L-Band</p> |            |
|        | 22  | 0x00400000 |  |   |            |
|        | 23  | 0x00800000 |  |   |            |
| N6     | 24  | 0x01000000 | Reserved   |   |            |
|        | 25  | 0x02000000 |  |   |            |
|        | 26  | 0x04000000 |  |   |            |
|        | 27  | 0x08000000 | Primary L1 channel                                   | 0 = Not primary, 1 = Primary  |            |

| Nibble | Bit | Mask       | Description                            | Range Value                                      |
|--------|-----|------------|--|--|
| N7     | 28  | 0x10000000 | Carrier phase measurement <sup>1</sup> | 0 = Half Cycle Not Added<br>1 = Half Cycle Added |
|        | 29  | 0x20000000 | Digital filtering on signal            | 0 = No digital filter<br>1 = Digital filter      |
|        | 30  | 0x40000000 | PRN lock flag <sup>2</sup>             | 0 = PRN Not Locked Out<br>1 = PRN Locked Out     |
|        | 31  | 0x80000000 | Channel assignment                     | 0 = Automatic, 1 = Forced                        |

**Table 124: Tracking State**

| State | Description                   |
|-------|-------------------------------|
| 0     | Idle                          |
| 1     | Sky Search                    |
| 2     | Wide frequency band pull-in   |
| 3     | Narrow frequency band pull-in |
| 4     | Phase lock loop               |
| 6     | Channel steering              |
| 7     | Frequency lock loop           |
| 9     | Channel alignment             |
| 10    | Code search                   |
| 11    | Aided phase lock loop         |
| 23    | Side peak detection           |

**Table 125: Correlator Type**

| State | Description |
|-------|-------------|
| 0     | N/A         |

<sup>1</sup>This bit is zero until the parity is known and the parity known flag (bit 11) is set to 1.

After a loss of lock, there is a half cycle ambiguity on the ADR (carrier phase) until enough navigation data has been decoded to determine the correct phase of the carrier. At the point this is determined, the "parity known" and "half cycle added" flags will get set. If the half cycle flag is set to 1, it indicates that a half cycle was added to the ADR to correct an inverted phase.

<sup>2</sup>A PRN can be locked out using the **LOCKOUT** command.



| State | Description                           |
|-------|---------------------------------------|
| 1     | Standard correlator: spacing = 1 chip |
| 2     | Narrow Correlator: spacing < 1 chip   |
| 3     | Reserved                              |
| 4     | Pulse Aperture Correlator (PAC)       |
| 5-6   | Reserved                              |

**Table 126: RINEX Mappings**

| GNSS System | Frequency Band | Frequency           | Observation Codes |               |         |                 |
|-------------|----------------|---------------------|-------------------|---------------|---------|-----------------|
|             |                |                     | Pseudo Range      | Carrier Phase | Doppler | Signal Strength |
| GPS         | L1             | 1575.42             | C1C               | L1C           | D1C     | S1C             |
|             |                |                     | C1L               | L1L           | D1L     | S1L             |
|             | L2             | 1227.6              | C2S               | L2S           | D2S     | S2S             |
|             |                |                     | L2P               | C2P           | D2P     | S2P             |
|             |                |                     | C2W               | L2W           | D2W     | S2W             |
| L5          | 1176.45        | C5Q                 | L5Q               | D5Q           | S5Q     |                 |
| GLONASS     | G1             | 1598.0625-1609.3125 | C1C               | L1C           | D1C     | S1C             |
|             | G2             | 1242.9375-1251.6875 | C2C               | L2C           | D2C     | S2C             |
|             | G3             | 1202.025            | C3Q               | L3Q           | D3Q     | S3Q             |
| Galileo     | E1             | 1575.42             | C1C               | L1C           | D1C     | S1C             |
|             | E5a            | 1176.45             | C5Q               | L5Q           | D5Q     | S5Q             |
|             | E5b            | 1207.14             | C7Q               | L7Q           | D7Q     | S7Q             |
|             | E5(E5a+E5b)    | 1191.795            | C8Q               | L8Q           | D8Q     | S8Q             |
| SBAS        | L1             | 1575.42             | C1C               | L1C           | D1C     | S1C             |
|             | L5             | 1176.45             | C5I               | L5I           | D5I     | S5I             |

| GNSS System | Frequency Band | Frequency | Observation Codes |               |         |                 |
|-------------|----------------|-----------|-------------------|---------------|---------|-----------------|
|             |                |           | Pseudo Range      | Carrier Phase | Doppler | Signal Strength |
| QZSS        | L1             | 1575.42   | C1C               | L1C           | D1C     | S1C             |
|             |                |           | C1L               | L1L           | D1L     | S1L             |
|             |                |           | C1Z               | L1Z           | D1Z     | S1Z             |
|             | L2             | 1227.6    | C2S               | L2S           | D2S     | S2S             |
|             | L5             | 1176.45   | C5Q               | L5Q           | D5Q     | S5Q             |
|             | L6             | 1278.75   | C6L               | L6L           | D6L     | S6L             |
| BeiDou      | B1             | 1561.098  | C2I               | L2I           | D2I     | S2I             |
|             | B2             | 1207.14   | C7I               | L7I           | D7I     | S7I             |
|             | B3             | 1268.52   | C6I               | L6I           | D6I     | S6I             |
| NavIC       | L5             | 1176.45   | C5A               | L5A           | D5A     | S5A             |

## 3.122 RANGECMP

### *Compressed version of the RANGE log*

**Platform: OEM719, OEM729, OEM7500, OEM7700, OEM7720, PwrPak7, HxGN PIM7500**

This log contains the RANGE data in a compressed format.



For dual antenna receivers, a RANGECMP\_1 log can be requested to get RANGECMP data from the second antenna. As described in *Table 3: Binary Message Header Structure* on page 30, the message type indicates the log is from the second antenna. To request an ASCII log enter RANGECMPA\_1, and for a binary log enter RANGECMPB\_1.

**Message ID: 140**

**Log Type: Synch**

**Recommended Input:**

```
log rangecmpa ontime 10
```

**ASCII Example:**

```
#RANGECMPA,COM1,0,63.5,FINESTEERING,
1429,226780.000,02000000,9691,2748;
26,
049c10081857f2df1f4a130ba2888eb9600603a709030000,
0b9c3001225bf58f334a130bb1e2bed473062fa609020000,
449c1008340400e0aaa9a109a7535bac2015cf71c6030000,
4b9c300145030010a6a9a10959c2f09120151f7166030000,
...
0b9d301113c8ffefc284000c6ea051dbf3089da1a0010000,
249d1018c6b7f67fa228820af2e5e39830180ae1a8030000,
2b9d301165c4f8fffb228820a500a089f31185fe0a8020000,
449d1018be18f41f2aacad0a1a934efc40074ecf88030000,
4b9d301182b9f69f38acad0a3e3ac28841079fcb88020000,
849d101817a1f95f16d7af0a69fbe1fa401d3fd064030000,
8b9d30112909fb2f20d7af0a9f24a687521ddece64020000,
249e1118af4e0470f66d4309a0a631cd642cf5b821320000,
2b9eb110a55903502f6e4309ee28d1ad032c7cb7e1320000,
849e1118b878f54f4ed2aa098c35558a532bde1765220000,
8b9eb110abcff71f5ed2aa09cb6ad0f9032b9d16c5220000*0eeead18
```



Consider the case where commercial vehicles are leaving a control center. The control center's coordinates are known but the vehicles are on the move. Using the control center's position as a reference, the vehicles are able to report where they are at any time. Post-processed information gives more accurate comparisons.

Post-processing can provide post mission position and velocity using raw GNSS collected from the vehicles. The logs necessary for post-processing include:

```
RANGECMPB ONTIME 1
RAWEPHEMB ONCHANGED
```

This is an example of data collection for post-processing. OEM7 based output is compatible with post-processing software from NovAtel's [Waypoint Products](http://www.novatel.com/support/). Refer to our website at [www.novatel.com/support/](http://www.novatel.com/support/) for more details.

| Field | Field Type                             | Description   | Format | Binary Bytes | Binary Offset    |
|-------|--|---|--------|--------------|------------------|
| 1     | RANGECMP header                        | Log header. See <i>Messages</i> on page 25 for more information.                              |        | H            | 0                |
| 2     | #obs                                   | Number of satellite observations with information to follow                                   | Ulong  | 4            | H                |
| 3     | 1st range record                       | Compressed range log in format of <i>Table 127: Range Record Format (RANGECMP only)</i> below | Hex    | 24           | H+4              |
| 4     | Next rangecmp offset = H+4 (#obs x 24) |   |        |              |                  |
| 5     | xxxx                                   | 32-bit CRC (ASCII and Binary only)  | Ulong  | 4            | H+4+ (#obs x 24) |
| 6     | [CR][LF]                               | Sentence terminator (ASCII only)  | -      | -            | -                |

**Table 127: Range Record Format (RANGECMP only)**

| Data                    | Description                  | Bits first to last | Length (bits) | Scale Factor  | Units |
|-------------------------|------------------------------|--------------------|---------------|---|-------|
| Channel Tracking Status | Channel tracking status word | 0-31               | 32            | see <i>Table 123: Channel Tracking Status</i> on page 662 | -     |

| Data              | Description   | Bits first to last | Length (bits) | Scale Factor                                      | Units  |
|-------------------|---|--------------------|---------------|---|--------|
| Doppler Frequency | Instantaneous carrier Doppler frequency   | 32-59              | 28            | 1/256   | Hz     |
| Pseudorange (PSR) | Pseudorange measurement   | 60-95              | 36            | 1/128   | m      |
| ADR               | <p>ADR (Accumulated Doppler Range) is calculated as follows:</p> $\text{ADR\_ROLLS} = (\text{RANGECMP\_PSR} / \text{WAVELENGTH} + \text{RANGECMP\_ADR}) / \text{MAX\_VALUE}$ <p>Round to the closest integer</p> <p>IF (ADR_ROLLS ≤ 0)<br/>           ADR_ROLLS = ADR_ROLLS - 0.5<br/>           ELSE<br/>           ADR_ROLLS = ADR_ROLLS + 0.5</p> <p>At this point integerise ADR_ROLLS<br/>           CORRECTED_ADR = RANGECMP_ADR - (MAX_VALUE*ADR_ROLLS)</p> <p>where<br/>           ADR has units of cycles<br/>           WAVELENGTH = 0.1902936727984 for GPS L1<br/>           WAVELENGTH = 0.2442102134246 for GPS L2<br/>           MAX_VALUE = 8388608</p> <p><b>Note:</b> GLONASS satellites emit L1 and L2 carrier waves at a satellite-specific frequency, refer to the GLONASS section of <a href="#">An Introduction to GNSS</a> available on our website</p> | 96-127             | 32            | 1/256   | cycles |
| StdDev-PSR        | Pseudorange measurement standard deviation  | 128-131            | 4             | See Table 128: StdDev-PSR Values on the next page | m      |
| StdDev-ADR        | ADR measurement standard deviation  | 132-135            | 4             | (n+1)/512   | cycles |

| Data                     | Description  | Bits first to last | Length (bits) | Scale Factor | Units |
|--------------------------|--|--------------------|---------------|--------------|-------|
| PRN/Slot                 | Refer to <i>PRN Numbers</i> on page 46   | 136-143            | 8             | 1            | -     |
| Lock Time                | Number of seconds of continuous tracking (no cycle slipping)<br>This field is constrained to a maximum value of 2,097,151 which represents a lock time of 65535.96875 s (2097151 / 32).  | 144-164            | 21            | 1/32         | s     |
| C/No                     | Carrier to noise density ratio<br>The C/No is constrained to a value between 20-51 dB-Hz. Thus, if it is reported that C/No = 20 dB-Hz, the actual value could be less. Likewise, if it is reported that C/No = 51, the true value could be greater. | 165-169            | 5             | (20+n)       | dB-Hz |
| GLONASS Frequency number | GLONASS Frequency number   | 170-175            | n+7           | 1            |       |
| Reserved                 |  | 176-191            | 16            |              |       |

**Table 128: StdDev-PSR Values**

| Code | StdDev-PSR (m) |
|------|----------------|
| 0    | 0.050          |
| 1    | 0.075          |
| 2    | 0.113          |
| 3    | 0.169          |
| 4    | 0.253          |
| 5    | 0.380          |
| 6    | 0.570          |
| 7    | 0.854          |
| 8    | 1.281          |
| 9    | 2.375          |

| <b>Code</b> | <b>StdDev-PSR (m)</b> |
|-------------|-----------------------|
| 10          | 4.750                 |
| 11          | 9.500                 |
| 12          | 19.000                |
| 13          | 38.000                |
| 14          | 76.000                |
| 15          | 152.00011             |

## 3.123 RANGECMP2

### *Compressed version of the RANGE log*

**Platform: OEM719, OEM729, OEM7500, OEM7700, OEM7720, PwrPak7, HxGN PIM7500**

This log contains the RANGE data in a compressed format to handle more channels and different channel types than the RANGECMP log.



For dual antenna receivers, a RANGECMP2\_1 log can be requested to get RANGECMP2 data from the second antenna. As described in *Table 3: Binary Message Header Structure* on page 30, the message type indicates the log is from the second antenna. To request an ASCII log enter RANGECMP2A\_1, and for a binary log enter RANGECMP2B\_1.

**Message ID: 1273**

**Log Type: Synch**

**Recommended Input:**

```
log rangecmp2a ontime 10
```

**Example:**

```
#RANGECMP2A,COM1,0,84.5,FINESTEERING,1681,163457.000,02000020,1fe3,
10526;634,000d00f4fddf05920620e1ffff2979e806e81301c8ffe4ffff03106b5a50
a902c8ff01100054f6bd05410720e1ffff2996ea0e90fb01e2ffe4ffff030e0d656816
03e3ff020400acdc605c40320e1ffff697b080e9859801300e4ffff4310c94fb8c701
14000317002c554685260520e1ffff295f4412b0ad03c4ffe4ffff03d5a60d18c705c4
ff0401008452b08583f92fe1ffff2998ac65302c800000e4ffff03f32edf784b000000
0520000c8500056cfd2fe1ffff295fa40dd04a822300e4ffff03b8242a58f802230006
1f00c0081385effb2fe1ffff295fc408a83884f8ffe4ffff03b8861608c286f8ff081e
008cb25105970520e1ffff295c2604989483ceffe4ffff03f2862f489006cfff091400
3027e204930020e1ffff695e4407188602ddffe4ffff43b8241480c903ddff0a0e0050
e3e305d3f92fe1ffff2979c89c506d800700e4ffff030f4bdd603a8006000b1900d8f3
cc8543fb2fe1ffff297a280950f2002500e4ffff03f1286880e8022500140118341c0f
0581f92fe1ffff299d4404d02401f2ffe4ffff03920c2f900d82faff160d158cfa6b85
400820e1ffff69baa600b83d02d9ffe4ffff03734a4380ea04ceff170b178874ef0409
fa2fe1ffff299d6409d01904e6ffe4ffff0374ea31304d87daff180213c8039884fd00
20e1ffff697fe401007082d4ffe4ffff033b0616688084c4ff19131a5cdc9585f9fe2f
e1ffff69b8c80e08e5800200e4ffff0357c830a8d001ebff1b0c16a45ca384c80220e1
ffff697f6401888a04effe4ffff033a463d605e8802001c031c905434051d0720e1ff
ff299cc60b18e881f3ffe4ffff0339462d38e182fbff231050f05e6406b9fd1fe6ffff
6998080f1013801300*61b80516
```



| Field | Field Type       | Description  | Format | Binary Bytes | Binary Offset  |
|-------|------------------|--|--------|--------------|----------------|
| 1     | RANGECMP2 header | Log header. See <i>Messages</i> on page 25 for more information.   |        | H            | 0              |
| 2     | # bytes          | Number of bytes in the compressed binary range data <sup>1</sup>   | Uchar  | 4            | H              |
| 3     | RangeData        | Compressed binary range data in the format of <i>Table 129: Satellite Block of the Range Record Format (RANGECMP2 only)</i> below and <i>Table 130: Signal Block of the Range Record Format (RANGECMP2 only)</i> on the next page <sup>2</sup> | Uchar  | #bytes       | H+4            |
| 4     | xxxx             | 32-bit CRC (ASCII and binary only)   | Hex    | 4            | H+4+ (# bytes) |
| 5     | [CR][LF]         | Sentence terminator (ASCII only)   | -      | -            | -              |

**Table 129: Satellite Block of the Range Record Format (RANGECMP2 only)**

| Data                         | Description   | Bits first to last | Length (bits) | Scale Factor | Units |
|------------------------------|---|--------------------|---------------|--------------|-------|
| SV Channel Number            | Receiver SV channel number  | 0-7                | 8             | -            | -     |
| Satellite Identifier         | Satellite identifier specific to the satellite system<br>Refer to <i>PRN Numbers</i> on page 46 | 8-15               | 8             | -            | -     |
| GLONASS Frequency Identifier | GLONASS frequency channel offset by +7  | 16-19              | 4             | (7+Ch#)      | -     |
| Satellite System Identifier  | Defined in <i>Table 102: Satellite System</i> on page 532                                       | 20-24              | 5             | -            | Enum  |
| Reserved                     |   | 25                 | 1             | -            | -     |

<sup>1</sup>Maximum is 2880 bytes for 120 channels; maximum 5760 for 240 channels.

<sup>2</sup>The compressed binary range data is organized into satellite blocks, one for each satellite. Each satellite block is followed by a variable number of signal blocks corresponding to the same satellite. For example, a Satellite Block for GPS PRN 17 may be followed by two Signal Blocks for the L1 C/A and L2C signals.

| Data                    | Description  | Bits first to last | Length (bits) | Scale Factor | Units |
|-------------------------|--|--------------------|---------------|--------------|-------|
| Pseudorange Base        | Pseudorange base value to be combined with PSR Diff and Phaserange Diff in each following Signal Block   | 26-54              | 29            | 1            | m     |
| Doppler Base            | Doppler base value to be combined with the Scaled Doppler Diff value in each following Signal Block  | 55-75              | 21            | 1            | Hz    |
| Number of Signal Blocks | The number of Signal Blocks to follow this Satellite Block. See <i>Table 130: Signal Block of the Range Record Format (RANGECMP2 only)</i> below for Signal Block definition | 76-79              | 4             | -            | -     |

**Table 130: Signal Block of the Range Record Format (RANGECMP2 only)**

| Data                      | Description   | Bits first to last | Length (bits) | Scale Factor | Units |
|---------------------------|---|--------------------|---------------|--------------|-------|
| Signal Type               | Defined in <i>Table 134: Signal Type (only in RANGECMP2)</i> on page 678                                | 0-4                | 5             | -            | Enum  |
| Phase Lock                | Phase Lock: 0 = Not locked, 1 = Locked  | 5                  | 1             | -            | Bool  |
| Parity Known              | Parity Known: 0 = Not known, 1 = Known  | 6                  | 1             | -            | Bool  |
| Code Lock                 | Code Lock: 0 = Not locked, 1 = Locked   | 7                  | 1             | -            | Bool  |
| Locktime                  | Time of continuous tracking with no cycle slips. The locktime value saturates at a maximum of 131071 ms | 8-24               | 17            | 1            | ms    |
| Correlator Type           | Correlator type: (see <i>Table 125: Correlator Type</i> on page 664)                                    | 25-28              | 4             | -            | Enum  |
| Primary Signal            | Primary signal: 0 = Not primary, 1 = Primary  | 29                 | 1             | -            | Bool  |
| Carrier Phase Measurement | Carrier phase measurement: 0 = Half cycle not added, 1 = Half cycle added                               | 30                 | 1             | -            | Bool  |
| Reserved                  |   | 31                 | 1             | -            | -     |
| C/No                      | Carrier to Noise density ratio  | 32-36              | 5             | (20 + n)     | dB-Hz |

| Data                             | Description  | Bits first to last | Length (bits) | Scale Factor  | Units        |
|----------------------------------|--|--------------------|---------------|---|--------------|
| StdDev PSR                       | Pseudorange Standard Deviation (defined <i>Table 131: Std Dev PSR Scaling</i> below)   | 37-40              | 4             | Bit Field in <i>Table 131: Std Dev PSR Scaling</i> below            | -            |
| StdDev ADR                       | Carrier-Phase Standard Deviation (defined <i>Table 132: Std Dev ADR Scaling</i> on the next page)  | 41-44              | 4             | Bit Field in <i>Table 132: Std Dev ADR Scaling</i> on the next page | -            |
| PSR Diff                         | Pseudorange Diff to be combined with Pseudorange base i.e.,<br>$PSR = PSRBase + PSRDiff/128$   | 45-58              | 14            | 1/128   | m (unsigned) |
| Phaserange Diff                  | Phaserange Diff to be combined with Pseudorange Base i.e.,<br>$ADR = PSRBase + PhaserangeDiff/2048$  | 59-78              | 20            | 1/2048  | m (unsigned) |
| Scaled Doppler Diff <sup>1</sup> | Doppler Diff to be combined with Doppler Base. Note that all Doppler values are scaled to the L1/E1 equivalent value. (refer to <i>Table 133: L1/E1/B1 Scaling</i> on page 677) i.e.,<br>$Doppler = (DopplerBase + ScaledDopplerDiff/256)/L1ScaleFactor$ | 79-95              | 17            | 1/256   | Hz (signed)  |

**Table 131: Std Dev PSR Scaling**

| PSR Std Dev Bit Field Value | Represented Std Dev (m) |
|-----------------------------|-------------------------|
| 0                           | 0.02                    |
| 1                           | 0.03                    |
| 2                           | 0.045                   |

<sup>1</sup>The Scaled Doppler Diff field is the only field in the RANGECP2 that should be parsed as Two's Complement. The most significant byte (MSB) determines whether the number will be positive (< 0x7) or negative (> 0x7). Two's complement should be applied prior to AND, right bit shift computations.

| PSR Std Dev Bit Field Value | Represented Std Dev (m) |
|-----------------------------|-------------------------|
| 3                           | 0.066                   |
| 4                           | 0.099                   |
| 5                           | 0.148                   |
| 6                           | 0.22                    |
| 7                           | 0.329                   |
| 8                           | 0.491                   |
| 9                           | 0.732                   |
| 10                          | 1.092                   |
| 11                          | 1.629                   |
| 12                          | 2.43                    |
| 13                          | 3.625                   |
| 14                          | 5.409                   |
| 15                          | >5.409                  |

Table 132: Std Dev ADR Scaling

| ADR Std Dev Bit Field Value | Represented Std Dev (cycles) |
|-----------------------------|------------------------------|
| 0                           | 0.00391                      |
| 1                           | 0.00521                      |
| 2                           | 0.00696                      |
| 3                           | 0.00929                      |
| 4                           | 0.01239                      |
| 5                           | 0.01654                      |
| 6                           | 0.02208                      |
| 7                           | 0.02947                      |
| 8                           | 0.03933                      |
| 9                           | 0.05249                      |
| 10                          | 0.07006                      |
| 11                          | 0.09350                      |
| 12                          | 0.12480                      |

| ADR Std Dev Bit Field Value | Represented Std Dev (cycles) |
|-----------------------------|------------------------------|
| 13                          | 0.16656                      |
| 14                          | 0.22230                      |
| 15                          | >0.22230                     |

**Table 133: L1/E1/B1 Scaling**

| Satellite System | Signal Type | L1/E1/B1 Scale Factor |
|------------------|-------------|-----------------------|
| GPS              | L1CA        | 1.0                   |
|                  | L2Y         | 154/120               |
|                  | L2C         | 154/120               |
|                  | L5Q         | 154/115               |
| GLONASS          | L1CA        | 1.0                   |
|                  | L2CA        | 9/7                   |
|                  | L2P         | 9/7                   |
| SBAS             | L1CA        | 1.0                   |
|                  | L5I         | 154/115               |
| Galileo          | E1          | 1.0                   |
|                  | E5A         | 154/115               |
|                  | E5B         | 154/118               |
|                  | AltBOC      | 154/116.5             |
| QZSS             | L1CA        | 1.0                   |
|                  | L2C         | 154/120               |
|                  | L5Q         | 154/115               |
| LBAND            | LBAND       | 1.0                   |
| BDS              | B1          | 1.0                   |
|                  | B2          | 1526/1180             |
| NAVIC            | L5SPS       | 1.0                   |

**Table 134: Signal Type (only in RANGECMP2)**

| Satellite System | Signal Type | Value |
|------------------|-------------|-------|
| GPS              | L1CA        | 1     |
|                  | L2Y         | 4     |
|                  | L2CM        | 5     |
|                  | L5Q         | 7     |
|                  | L1C         | 15    |
| GLONASS          | L1CA        | 1     |
|                  | L2CA        | 3     |
|                  | L2P         | 4     |
| SBAS             | L1CA        | 1     |
|                  | L5I         | 2     |
| Galileo          | E1C         | 1     |
|                  | E5AQ        | 2     |
|                  | E5BQ        | 3     |
|                  | AltBOCQ     | 4     |
| QZSS             | L1CA        | 1     |
|                  | L2CM        | 3     |
|                  | L5Q         | 4     |
|                  | L1C         | 8     |
|                  | L6          | 11    |
| LBAND            | LBAND       | 1     |
| BDS              | B1D1I       | 1     |
|                  | B1D2I       | 2     |
|                  | B2D1I       | 3     |
|                  | B2D2I       | 4     |
| NAVIC            | L5SPS       | 1     |

## 3.124 RANGECMP4

### *Highly compressed version of the RANGE log*

**Platform: OEM719, OEM729, OEM7500, OEM7700, OEM7720, PwrPak7, HxGN PIM7500**

This log contains the RANGE data in a more heavily compressed format compared to the RANGECMP2 log.



For dual antenna receivers, a RANGECMP4\_1 log can be requested to get RANGECMP4 data from the second antenna. As described in *Table 3: Binary Message Header Structure* on page 30, the message type indicates the log is from the second antenna. To request an ASCII log enter RANGECMP4A\_1, and for a binary log enter RANGECMP4B\_1.

**Message ID: 2050**

**Log Type: Synch**

**Recommended Input:**

```
log rangecmp4a ontime 10
```



**Example:**

```
#RANGECMP4A,COM1,0,81.5,FINESTEERING,1921,228459.000,00000020,fb0e,
32768;627,630032090851000000009200dbbf7d8306f822d0a3b2bc897f0010d35042
8cf31228ea9f7300040050ff5e641cb7c7463d2a00b6a4644f6e5ee2a0fe530a00fe1f
829dcfe4cf30d52abaf37f94e01621cd8d8c04a0bafcaf00e43b0761690064e7bfe90f
11ce8710a4eb2b573202607403fc28e647c6fe9f550118007a9d839c2680ebfedff687
6be81150411adbc972feef4686c483f30a09f01773ff0b0050d8b8a843f41576b94100
440e1e4f59ace54fffca2700fc1f62e14720f4facba64affbf9c52ff39ce4b3eef9f14
fd0f00244387d00d80fefabfeb0fb3cf456ae97542d410fc9ffab7f601e73580e5efda
ff0f00a0b33991fc072ccbaa99ff134efa9fd0dc684bfc61f0fffeff60b02000000000
8004c0ff3fa0b2f724f7e1eee889e9fb9f3977c0437391ab135877fe0b00301edf93f4
bd63c62850fdbf8527e6e5cd438e3a208400e0ff43bb6f5fc2101c75b058daff375c5e
a4378f51940022effffff0fe1c97dcda81887c83a63007c9d5a7ed65ce6f901427bffff
3f9c04f735db1d55294a3bfc5f35ccc66df318c412181400140060eedbd7285feaf6a6
53f9bf9fc7fe27cd653633c0b5fcffff03197b4f8228d4e59d0cfbffa731b2f73b07e9
b68078f47f0000a9be7dcdcc51898da269fe839b6191ab9cc67701f21000fc3f0001a1
000000008002c03fb4362793b9bfeb657dfcffe6badabb9a4375b77f5bfff1fed87bce6
4454a98ae16c14ff4fec6f7a48f3206b03e8040138fbd0023d225492cd7679a4ffa562
3b08810e42bf05fce17fa41f9a9ccfc8e2626231edf2ff208a1225ce6150204067febf
ef030100000000000028000ca9cc8728bb3306e68af97f921cfce3e632f0d1cf8300c8
f701*6de99eb7
```

| Field | Field Type       | Description   | Format | Binary Bytes | Binary Offset  |
|-------|------------------|---|--------|--------------|----------------|
| 1     | RANGECMP4 header | Log header. See <i>Messages</i> on page 25 for more information.  | -      | H            | 0              |
| 2     | # bytes          | Number of bytes in the compressed binary Range Data.  | Uchar  | 4            | H              |
| 3     | Range Data       | <p>The compressed binary range data is organized into satellite system blocks which break down into measurement blocks for each active signal within each system. Refer to the following tables for more details about this format:</p> <p><i>Table 135: Header</i> on the next page (sent once)</p> <p><i>Table 136: Satellite and Signal Block</i> on page 682 (sent once per satellite system bit set to 1 in the GNSS Field found in <i>Table 135: Header</i> on the next page)</p> <p><i>Table 137: Measurement Block Header</i> on page 683 (sent once for each bit set to 1 in the Satellites Field found in <i>Table 136: Satellite and Signal Block</i> on page 682)</p> <p><i>Table 138: Primary Reference Signal Measurement Block</i> on page 684 and <i>Table 139: Secondary Reference Signals Measurement Block</i> on page 685, or <i>Table 140: Primary Differential Signal Measurement Block</i> on page 686 and <i>Table 141: Secondary Differential Signals Measurement Block</i> on page 687, Measurement Block (sent for each bit set to 1 in the Included Signals Field for a given satellite found in <i>Table 136: Satellite and Signal Block</i> on page 682)</p> <div style="border: 1px solid black; padding: 5px; margin-top: 10px;">  <p>The byte data is received MSB first so each group of bytes (as defined by the number of needed bits) must be swapped prior to processing.</p> </div> | Uchar  | # bytes      | H+4            |
| 4     | xxxx             | 32-bit CRC (ASCII only)   | Hex    | 4            | H+4+ (# bytes) |
| 5     | [CR][LF]         | Sentence terminator (ASCII only)  | -      | -            | -              |





**Table 135: Header**

| Data Name   | Description  | Bits | Scale Factor |
|---|--|------|--------------|
| GNSS  | <p>Indicates which satellite system data is encoded and in what order. When the bit is set the satellite data is included. Data for each system is encoded sequentially:</p> <ul style="list-style-type: none"> <li>Bit 0 = GPS</li> <li>Bit 1 = GLONASS</li> <li>Bit 2 = SBAS</li> <li>Bit 5 = Galileo</li> <li>Bit 6 = BeiDou</li> <li>Bit 7 = QZSS</li> <li>Bit 9 = NavIC</li> </ul> <div style="border: 1px solid black; background-color: #f0f0f0; padding: 5px; margin-top: 10px;">  L-Band channels are not reported.         </div> | 16   | 1            |
| Bit Sum:  |  | 16   |              |
| <div style="border: 1px solid black; background-color: #e0e0e0; padding: 5px;">  This block is sent once per message         </div> |  |      |              |



**Table 136: Satellite and Signal Block**

| Data Name   | Range               | Description  | Bits     | Scale Factor |
|---|---------------------|--|----------|--------------|
| Satellites  | 0...<br>1.84467E+19 | <p>Indicates which satellites are present for this system and their order in the message. Each PRN is represented by a bit. (Bit 0 = PRN 1, Bit 1 = PRN 2, ...)</p> <p><b>Notes:</b></p> <ul style="list-style-type: none"> <li>Manually assigned channels are not reported.</li> <li>GLONASS Satellite: This value represents the Slot ID of the satellite (range of 1 to 24 where Bit 0 = Slot ID 1). In the event the Slot ID is between 43 and 63, the actual GLONASS Slot ID has not yet been determined and has been replaced with a temporary Slot ID calculated using the GLONASS Frequency Number. See the GLONASS Frequency Number field in <i>Table 137: Measurement Block Header</i> on the next page for more details.</li> <li>SBAS Satellite PRNs 120 to 158 are offset by 120. (Bit 0 = PRN 120, Bit 1 = 121, ...)</li> <li>SBAS Satellite PRNs 183 to 187 are offset by 130</li> <li>QZSS Satellite PRNs are offset by 193</li> </ul> | 64       | 1            |
| Signals   | 0... 65535          | Indicates which signals are present for this system and their order in the message. Each signal is represented by a bit as defined in <i>Table 142: Signal BitMask</i> on page 688.  | 16       | 1            |
| Included Signals  | 0... mxn            | <p>A two dimensional field to tell the decoder which signals are present for each of the satellites.</p> <p><b>m</b> = The number of rows equals the number of bits set to 1 found in the Satellites field. (Maximum number of PRNs in the satellite system)</p> <p><b>n</b> = The number of columns equals the number of bits set to 1 found in the Signals field. (Maximum number of Signals in the satellite system)</p>  | mxn      |              |
| Bit Sum:  |                     |  | 80 + mxn |              |
| <div style="border: 1px solid black; padding: 10px; display: inline-block;">  This block is sent once for each bit set to 1 in the GNSS field found in <i>Table 135: Header</i> on the previous page.         </div> |                     |  |          |              |

**Table 137: Measurement Block Header**

| Data Name  | Range               | Description  | Bits            | Scale Factor |
|--|---------------------|--|-----------------|--------------|
| Data Format Flag   | 0... 1              | Identifies what type of Measurement Block will be used:<br>0 = Reference<br>(Table 138: Primary Reference Signal Measurement Block on the next page and Table 139: Secondary Reference Signals Measurement Block on page 685)<br>1 = Differential<br>(Table 140: Primary Differential Signal Measurement Block on page 686 and Table 141: Secondary Differential Signals Measurement Block on page 687)  | 1               | 1            |
| Ref Data Block ID  | 0... 7              | This ID identifies to which reference data the Differential Data is linked. This value is incremented by 1 each time a new Reference Measurement Block is used.  | 3               | 1            |
| GLONASS Frequency Number   | 0... 20 (-7 to +13) | These bits are only present for GLONASS satellites in the Reference Data. This represents the GLONASS Frequency Number which identifies the frequency offset of the carrier frequency. The value will appear as a number between 0 and 20 which directly translates into a frequency offset number between -7 to +13.<br><br>If the GLONASS Slot ID is unknown, a temporary Slot ID for this satellite will be set between 43 and 63 based on the GLONASS Frequency Number:<br>$PRN = 63 - \text{GLONASS Frequency Number}$ <div data-bbox="467 1178 1219 1335" style="border: 1px solid black; padding: 5px; margin-top: 10px;">  The GLONASS Frequency Number used in this calculation is the 0 to 20 value, not the adjusted -7 to +13 value.         </div> | 5               | 1            |
| Bit Sum:   |                     |  | 4 (Non-GLONASS) | 9 (GLONASS)  |
| <div data-bbox="191 1524 256 1587" style="float: left; margin-right: 10px;">  </div> This block is sent once for each bit set to 1 in the Satellites field found in Table 136: Satellite and Signal Block on the previous page. |                     |  |                 |              |

**Table 138: Primary Reference Signal Measurement Block**

| Data Name   | Range            | Description  | Bits | Scale Factor |
|---|------------------|--|------|--------------|
| Parity Flag   | 0... 1           | 0 = Parity Unknown<br>1 = Parity Known   | 1    | 1            |
| ½ Cycle Flag  | 0... 1           | 0 = Half Cycle Not Added<br>1 = Half Cycle Added   | 1    | 1            |
| C/No  | 0... 63.95       | C/No   | 11   | 0.05 dBHz    |
| Lock Time   | 0... 15          | The Lock Time – See <i>Table 143: Lock Time</i> on page 689  | 4    | 1            |
| Pseudorange Std Dev   | 0... 15          | The Pseudorange Standard Deviation (m) – See <i>Table 145: Pseudorange Std Dev</i> on page 691   | 4    | 1            |
| ADR Std Dev   | 0... 15          | The ADR Standard Deviation (cycles) – See <i>Table 144: ADR Std Dev</i> on page 690  | 4    | 1            |
| Primary Pseudorange   | 0... 68719476.74 | The Pseudo Range of the 1st signal (Signals field in <i>Table 136: Satellite and Signal Block</i> on page 682).<br>If this value equals $(2^{37}-1) = 137438953471$ , it represents a signal that is not locked. | 37   | 0.0005 m     |
| PhaseRange – Primary Pseudorange  | ±419.4303        | (2's Complement)<br>If this value equals $-(2^{23}-1) = -4194304$ , it represents the signal is not locked.  | 23   | 0.0001 m     |
| Primary Doppler   | +/- 3355.4431    | (2's Complement)<br>If this value equals $-(2^{26}-1) = -33554432$ , it represents an invalid Doppler.   | 26   | 0.0001 m/s   |
| Bit Sum:  |                  |  | 111  |              |
| <p> This block is sent once for the first bit set to 1 in the Included Signals field found in <i>Table 136: Satellite and Signal Block</i> on page 682. For any bits set to 1 after the first bit set to 1, refer to <i>Table 139: Secondary Reference Signals Measurement Block</i> on the next page.</p> |                  |  |      |              |
| <p> This table is for Reference blocks only, as indicated by the Data Format Flag (see <i>Table 137: Measurement Block Header</i> on the previous page).</p>   |                  |  |      |              |

**Table 139: Secondary Reference Signals Measurement Block**

| Data Name                                | Range      | Description  | Bits | Scale Factor |
|--|------------|--|------|--------------|
| Parity Flag                              | 0... 1     | 0 = Parity Unknown<br>1 = Parity Known   | 1    | 1            |
| ½ Cycle Flag                             | 0... 1     | 0 = Half Cycle Not Added<br>1 = Half Cycle Added   | 1    | 1            |
| C/No Indicator                           | 0... 63.95 | C/No   | 11   | 0.05 dBHz    |
| Lock Time                                | 0... 15    | The Lock Time – See <i>Table 143: Lock Time</i> on page 689  | 4    | 1            |
| Pseudorange Std Dev                      | 0... 15    | The Pseudorange Standard Deviation (m) – See <i>Table 145: Pseudorange Std Dev</i> on page 691             | 4    | 1            |
| ADR Std Dev                              | 0... 15    | The ADR Standard Deviation (cycles) – See <i>Table 144: ADR Std Dev</i> on page 690                        | 4    | 1            |
| Pseudorange – Primary Signal Pseudorange | ±262.1435  | (2's Complement)<br>If this value equals $-(2^{20}-1) = -524288$ , it indicates the signal is not locked.  | 20   | 0.0005 m     |
| Phaserange – Pseudorange                 | ±419.4303  | (2's Complement)<br>If this value equals $-(2^{23}-1) = -4194304$ , it indicates the signal is not locked. | 23   | 0.0001 m     |
| Doppler – Primary Doppler                | ±0.8191    | (2's Complement)<br>If this value equals $-(2^{14}-1) = -8192$ , it indicates an invalid Doppler.          | 14   | 0.0001 m/s   |
| Bit Sum:                                 |            |  | 82   |              |





This block is sent once for each bit set to 1 after the first bit set to 1 in the Included Signals field found in *Table 136: Satellite and Signal Block* on page 682.



This table is for Reference blocks only, as indicated by the Data Format Flag (see *Table 137: Measurement Block Header* on page 683).



**Table 140: Primary Differential Signal Measurement Block**

| <b>Data Name</b>                    | <b>Range</b> | <b>Description</b>  | <b>Bits</b> | <b>Scale Factor</b> |
|-------------------------------------|--------------|---|-------------|---------------------|
| Parity Flag                         | 0... 1       | 0 = Parity Unknown<br>1 = Parity Known  | 1           | 1                   |
| ½ Cycle Flag                        | 0... 1       | 0 = Half Cycle Not Added<br>1 = Half Cycle Added  | 1           | 1                   |
| C/No                                | 0... 63.95   | C/No  | 11          | 0.05 dBHz           |
| Lock Time                           | 0... 15      | The Lock Time – See <i>Table 143: Lock Time</i> on page 689   | 4           | 1                   |
| Pseudorange Std Dev                 | 0... 15      | The Pseudorange Standard Deviation (m) – See <i>Table 145: Pseudorange Std Dev</i> on page 691  | 4           | 1                   |
| ADR Std Dev                         | 0... 15      | The ADR Standard Deviation (cycles) – See <i>Table 144: ADR Std Dev</i> on page 690   | 4           | 1                   |
| Pseudorange – Predicted Pseudorange | ±131.0715    | (2's Complement)<br>If this value equals $-(2^{19}-1) = -262144$ , it indicates a signal that is not locked.<br><br>The Predicted Pseudorange = reference pseudorange plus (the reference doppler x time difference between the reference log and the differential log). The Reference log and Differential logs used must contain matching Ref Data Block ID references ( <i>Table 137: Measurement Block Header</i> on page 683). | 19          | 0.0005 m            |
| Phaserange – Predicted Phaserange   | ±3.2767      | (2's Complement)<br>If this value equals $-(2^{16}-1) = -32768$ , it indicates the signal is not locked.<br><br>The Predicted Phaserange = reference phaserange plus (the reference doppler x time difference between the reference log and the differential log). The Reference log and Differential logs used must contain matching Ref Data Block ID references ( <i>Table 137: Measurement Block Header</i> on page 683).       | 16          | 0.0001 m            |

| Data Name  | Range    | Description   | Bits | Scale Factor |
|--|----------|---|------|--------------|
| Doppler – Reference Doppler  | ±13.1071 | (2's Complement)<br>If this value equals $-(2^{18}-1) = -131072$ , it indicates an invalid Doppler.<br><br>The Reference Doppler is the Doppler for that PRN and for that signal from the Reference log. The Reference log and Differential logs used must contain matching Ref Data Block ID references ( <i>Table 137: Measurement Block Header</i> on page 683). | 18   | 0.0001 m/s   |
| Bit Sum:   |          |   | 78   |              |
| <div style="border: 1px solid black; padding: 10px; margin-bottom: 10px;">  This block is sent once for each bit set to 1 after the first bit set to 1 in the Included Signals field found in <i>Table 136: Satellite and Signal Block</i> on page 682. For any bits set to 1 after the first bit set to 1, refer to <i>Table 141: Secondary Differential Signals Measurement Block</i> below. </div> <div style="border: 1px solid black; padding: 10px;">  This table is for Differential blocks only, as indicated by the Data Format Flag (see <i>Table 137: Measurement Block Header</i> on page 683). </div> |          |   |      |              |

**Table 141: Secondary Differential Signals Measurement Block**

| Data Name           | Range      | Description  | Bits | Scale Factor |
|---------------------|------------|--|------|--------------|
| Parity Flag         | 0... 1     | 0 = Parity Unknown<br>1 = Parity Known   | 1    | 1            |
| ½ Cycle Flag        | 0... 1     | 0 = Half Cycle Not Added<br>1 = Half Cycle Added   | 1    | 1            |
| C/No                | 0... 63.95 | C/No   | 11   | 0.05 dBHz    |
| Lock Time           | 0... 15    | The Lock Time – See <i>Table 143: Lock Time</i> on page 689                                    | 4    | 1            |
| Pseudorange Std Dev | 0... 15    | The Pseudorange Standard Deviation (m) – See <i>Table 145: Pseudorange Std Dev</i> on page 691 | 4    | 1            |
| ADR Std Dev         | 0... 15    | The ADR Std Dev (cycles)– See <i>Table 144: ADR Std Dev</i> on page 690                        | 4    | 1            |

| Data Name   | Range     | Description  | Bits | Scale Factor  |
|---|-----------|--|------|---------------|
| Pseudorange<br>– Predicted<br>Pseudorange   | ±131.0715 | (2's Complement)<br>If this value equals $-(2^{19}-1) = -262144$ , it indicates the signal is not locked.<br><br>The Predicted Pseudorange = reference pseudorange plus (the reference doppler x time difference between the reference log and the differential log). The Reference log and Differential logs used must contain matching Ref Data Block ID references ( <i>Table 137: Measurement Block Header</i> on page 683). | 19   | 0.0005<br>m   |
| Phaserange<br>– Predicted<br>Phaserange   | ±3.2767   | (2's Complement)<br>If this value equals $-(2^{16}-1) = -32768$ , it indicates the signal is not locked.<br><br>The Predicted Phaserange = reference phaserange plus (the reference doppler x time difference between the reference log and the differential log). The Reference log and Differential logs used must contain matching Ref Data Block ID references ( <i>Table 137: Measurement Block Header</i> on page 683).    | 16   | 0.0001<br>m   |
| Doppler –<br>Reference<br>Doppler   | ±13.1071  | (2's Complement)<br>If this value equals $-(2^{14}-1) = -8192$ , it indicates an invalid Doppler.<br><br>The Reference Doppler is the Doppler for that PRN and for that signal from the Reference log. The Reference log and Differential logs used must contain matching Ref Data Block ID references ( <i>Table 137: Measurement Block Header</i> on page 683).  | 14   | 0.0001<br>m/s |
| Bit Sum:  |           |  | 74   |               |
| <div style="border: 1px solid black; padding: 5px; margin-bottom: 10px;">  This block is sent once for each bit set to 1 after the first bit set to 1 in the Included Signals field found in <i>Table 136: Satellite and Signal Block</i> on page 682. </div> <div style="border: 1px solid black; padding: 5px;">  This table is for Differential blocks only, as indicated by the Data Format Flag (see <i>Table 137: Measurement Block Header</i> on page 683). </div> |           |  |      |               |

**Table 142: Signal BitMask**

|              | GPS  | GLONASS | SBAS | Galileo | BeiDou | QZSS | NavIC |
|--------------|------|---------|------|---------|--------|------|-------|
| <b>Bit 1</b> | L1CA | L1CA    | L1CA | E1      | B1     | L1CA | L5SPS |



|               | GPS | GLONASS | SBAS | Galileo | BeiDou | QZSS | NavIC |
|---------------|-----|---------|------|---------|--------|------|-------|
| <b>Bit 2</b>  |     |         | L5I  | E5A     | B1GEO  |      |       |
| <b>Bit 3</b>  |     | L2CA    |      | E5B     | B2     | L2C  |       |
| <b>Bit 4</b>  | L2Y | L2P     |      | ALTBOC  | B2GEO  | L5Q  |       |
| <b>Bit 5</b>  | L2C |         |      |         | B3     |      |       |
| <b>Bit 6</b>  | L2P | L3      |      |         | B3GEO  |      |       |
| <b>Bit 7</b>  | L5Q |         |      |         |        |      |       |
| <b>Bit 8</b>  |     |         |      |         |        | L1C  |       |
| <b>Bit 9</b>  |     |         |      |         |        |      |       |
| <b>Bit 10</b> |     |         |      |         |        |      |       |
| <b>Bit 11</b> |     |         |      |         |        |      |       |
| <b>Bit 12</b> |     |         |      |         |        |      |       |
| <b>Bit 13</b> |     |         |      |         |        |      |       |
| <b>Bit 14</b> |     |         |      |         |        |      |       |
| <b>Bit 15</b> | L1C |         |      |         |        |      |       |

**Table 143: Lock Time**

| Indicator (i) | Minimum Lock Time (ms) | Range of Indicated Lock Times (t represents the Lock Time) (ms) |
|---------------|------------------------|---|
| 0             | 0                      | $0 \leq t < 16$   |
| 1             | 16                     | $16 \leq t < 32$  |
| 2             | 32                     | $32 \leq t < 64$  |
| 3             | 64                     | $64 \leq t < 128$   |
| 4             | 128                    | $128 \leq t < 256$  |
| 5             | 256                    | $256 \leq t < 512$  |
| 6             | 512                    | $512 \leq t < 1024$   |
| 7             | 1024                   | $1024 \leq t < 2048$  |
| 8             | 2048                   | $2048 \leq t < 4096$  |
| 9             | 4096                   | $4096 \leq t < 8192$  |

| Indicator (i) | Minimum Lock Time (ms) | Range of Indicated Lock Times (t represents the Lock Time) (ms) |
|---------------|------------------------|---|
| 10            | 8192                   | $8192 \leq t < 16384$   |
| 11            | 16384                  | $16384 \leq t < 32768$  |
| 12            | 32768                  | $32768 \leq t < 65536$  |
| 13            | 65536                  | $65536 \leq t < 131072$   |
| 14            | 131072                 | $131072 \leq t < 262144$  |
| 15            | 262144                 | $262144 \leq t$   |

**Table 144: ADR Std Dev**

| ADR Std Dev (cycles) |               |
|----------------------|---------------|
| 0                    | $\leq 0.0039$ |
| 1                    | $\leq 0.0052$ |
| 2                    | $\leq 0.0070$ |
| 3                    | $\leq 0.0093$ |
| 4                    | $\leq 0.0124$ |
| 5                    | $\leq 0.0165$ |
| 6                    | $\leq 0.0221$ |
| 7                    | $\leq 0.0295$ |
| 8                    | $\leq 0.0393$ |
| 9                    | $\leq 0.0525$ |
| 10                   | $\leq 0.0701$ |
| 11                   | $\leq 0.0935$ |
| 12                   | $\leq 0.1248$ |
| 13                   | $\leq 0.1666$ |
| 14                   | $\leq 0.2223$ |
| 15                   | $> 0.2223$    |

**Table 145: Pseudorange Std Dev**

| <b>Pseudorange Std Dev (m)</b> |         |
|--------------------------------|---------|
| 0                              | ≤ 0.020 |
| 1                              | ≤ 0.030 |
| 2                              | ≤ 0.045 |
| 3                              | ≤ 0.066 |
| 4                              | ≤ 0.099 |
| 5                              | ≤ 0.148 |
| 6                              | ≤ 0.220 |
| 7                              | ≤ 0.329 |
| 8                              | ≤ 0.491 |
| 9                              | ≤ 0.732 |
| 10                             | ≤ 1.092 |
| 11                             | ≤ 1.629 |
| 12                             | ≤ 2.430 |
| 13                             | ≤ 3.625 |
| 14                             | ≤ 5.409 |
| 15                             | > 5.409 |



For more information about decoding the RANGECP4 log, refer to *Example of Bit Parsing a RANGECP4 Log* on page 1022.

## 3.125 RANGEGPSL1

### *L1 version of the RANGE log*

**Platform: OEM719, OEM729, OEM7500, OEM7700, OEM7720, PwrPak7, HxGN PIM7500**

This log is identical to the **RANGE** log (see page 658) except that it only includes L1 GPS observations.

**Message ID: 631**

**Log Type: Synch**

**Recommended Input:**

```
log rangegpsl1a ontime 30
```

**ASCII Example:**

```
#RANGEGPSL1A,COM1,0,57.0,FINESTEERING,1337,404766.000,02000000,5862,
1984;
10,
14,0,21773427.400,0.037,-114420590.433332,0.006,2408.171,49.9,
14963.280,18109c04,
22,0,24822942.668,0.045,-130445851.055756,0.009,-3440.031,48.0,
22312.971,08109c24,
25,0,20831000.299,0.033,-109468139.214586,0.006,1096.876,50.7,
7887.840,08109c44,
1,0,20401022.863,0.032,-107208568.887106,0.006,-429.690,51.1,
10791.500,18109c64,
24,0,23988223.932,0.074,-126058964.619453,0.013,2519.418,43.8,
493.550,18109c84,
11,0,22154466.593,0.043,-116423014.826717,0.007,-1661.273,48.4,
11020.952,08109ca4,
5,0,24322401.516,0.067,-127815012.260616,0.012,-1363.596,44.6,
6360.282,18109cc4,
20,0,22294469.347,0.043,-117158267.467388,0.008,2896.813,48.5,
4635.968,08109ce4,
30,0,23267589.649,0.051,-122271969.418761,0.009,822.194,47.0,
4542.270,08109d04,
23,0,24975654.673,0.058,-131247903.805678,0.009,3395.097,45.9,
406.762,18109d24*be4b7d70
```



Since the RANGEGPSL1 log includes only L1 GPS observations, it is smaller in size than the RANGE log which contains entries for multiple systems and signals. Use the RANGEGPSL1 log when data throughput is limited and you are only interested in GPS L1 range data. For GPS L1 only models, RANGE and RANGEGPSL1 logs are identical.

| Field | Field type                                    | Description   | Format | Binary Bytes | Binary Offset          |
|-------|---|---|--------|--------------|------------------------|
| 1     | RANGEGPSL1 header                             | Log header. See <i>Messages</i> on page 25 for more information.            |        | H            | 0                      |
| 2     | # obs   | Number of L1 observations with information to follow                        | Long   | 4            | H                      |
| 3     | PRN   | Satellite PRN number of range measurement (1-32)                            | Ushort | 2            | H+4                    |
| 4     | Reserved                                      |   | Ushort | 2            | H+6                    |
| 5     | psr   | Pseudorange measurement (m)   | Double | 8            | H+8                    |
| 6     | psr std                                       | Pseudorange measurement standard deviation (m)                              | Float  | 4            | H+16                   |
| 7     | adr   | Carrier phase, in cycles (accumulated Doppler range)                        | Double | 8            | H+20                   |
| 8     | adr std                                       | Estimated carrier phase standard deviation (cycles)                         | Float  | 4            | H+28                   |
| 9     | dopp  | Instantaneous carrier Doppler frequency (Hz)                                | Float  | 4            | H+32                   |
| 10    | C/No  | Carrier to noise density ratio<br>$C/No = 10[\log_{10}(S/N_0)]$ (dB-Hz)     | Float  | 4            | H+36                   |
| 11    | locktime                                      | Number of seconds of continuous tracking (no cycle slipping)                | Float  | 4            | H+40                   |
| 12    | ch-tr-status                                  | Tracking status (see <i>Table 123: Channel Tracking Status</i> on page 662) | Ulong  | 4            | H+44                   |
| 13... | Next PRN offset = $H + 4 + (\#obs \times 44)$ |   |        |              |                        |
| 14    | xxxx  | 32-bit CRC (ASCII and Binary only)  | Ulong  | 4            | H+4+<br>(#obs<br>x 44) |
| 15    | [CR][LF]                                      | Sentence terminator (ASCII only)  | -      | -            | -                      |

## 3.126 RAWALM

### *Raw GPS Almanac data*

**Platform: OEM719, OEM729, OEM7500, OEM7700, OEM7720, PwrPak7, HxGN PIM7500**

This log contains the undecoded GPS almanac subframes as received from the satellite. For more information about Almanac data, refer to [An Introduction to GNSS](#) available on our website.

**Message ID: 74**

**Log Type: Asynch**

**Recommended Input:**

```
log rawalma onchanged
```

**ASCII Example:**

```
#RAWALMA, COM1, 0, 56.0, SATTIME, 1337, 405078.000, 02000000, cc1b, 1984; 1337, 5
89824.000, 43,
3, 8b04e4839f35433a5590f5aefd3900a10c9aaa6f40187925e50b9f03003f,
27, 8b04e483a1325b9cde9007f2fd5300a10da5562da3adc0966488dd01001a,
4, 8b04e483a1b44439979006e2fd4f00a10d15d96b3b021e6c6c5f23feff3c,
28, 8b04e483a3b05c5509900b7cfd5800a10cc483e2bfa1d2613003bd050017,
5, 8b04e483a43745351c90fcb0fd4500a10d8a800f0328067e5df8b6100031,
57, 8b04e483a6337964e036d74017509f38e13112df8dd92d040605eeaaaaaa,
6, 8b04e483a6b54633e390fa8bfd3f00a10d4facbc80b322528f62146800ba,
29, 8b04e483a8b05d47f7901b20fd5700a10ce02d570ed40a0a2216412400cb,
7, 8b04e483a935476dee90fb94fd4300a10d93aba327b7794ae853c02700ba,
...
1, 8b04e483d8b641305a901b9dfd5a00a10ce92f48f1ba0a5dccc7500003b,
25, 8b04e483dab25962259004fcfd4c00a10dc154eee5c555d7a2a5010d000d,
2, 8b04e483db37424aa6900720fd4f00a10c5ad89baa4dc1460790b6fc000f,
26, 8b04e483dd305a878c901d32fd5b00a10c902eb7f51db6b6ce95c701fff4*83cae9
7a
```



The OEM7 family of receivers automatically saves almanacs in their Non-Volatile Memory (NVM), therefore creating an almanac boot file is not necessary.

| Field | Field type    | Description  | Format | Binary Bytes | Binary Off-set |
|-------|---------------|--|--------|--------------|----------------|
| 1     | RAWALM header | Log header. See <i>Messages</i> on page 25 for more information. |        | H            | 0              |
| 2     | ref week      | Almanac reference week number                                    | Ulong  | 4            | H              |

| Field | Field type                                   | Description   | Format | Binary Bytes | Binary Offset                 |
|-------|--|---|--------|--------------|-------------------------------|
| 3     | ref secs                                     | Almanac reference time (ms)   | GPSec  | 4            | H+4                           |
| 4     | #subframes                                   | Number of subframes to follow   | Ulong  | 4            | H+8                           |
| 5     | svid   | <p>SV ID (satellite vehicle ID)</p> <p>A value between 1 and 32 for the SV ID indicates the PRN of the satellite. Any other values indicate the page ID.</p> <div style="border: 1px solid black; padding: 5px; margin: 10px 0;">  See section 20.3.3.5.1.1, Data ID and SV ID, of ICD-GPS-200C for more details. To obtain copies of ICD-GPS-200, refer to the GPS website (<a href="http://www.gps.gov/">www.gps.gov/</a>). </div> | Ushort | 2            | H+12                          |
| 6     | data   | Subframe page data  | Hex    | 30           | H+14                          |
| 7...  | Next subframe offset = H+12+(#subframe x 32) |   |        |              |                               |
| 8     | xxxx   | 32-bit CRC (ASCII and Binary only)  | Hex    | 4            | H+12+<br>(#subframes<br>x 32) |
| 9     | [CR][LF]                                     | Sentence terminator (ASCII only)  | -      | -            | -                             |

## 3.127 RAWCNAVFRAME

### *Raw GPS CNAV frame data*

**Platform: OEM719, OEM729, OEM7500, OEM7700, OEM7720, PwrPak7, HxGN PIM7500**

This log provides raw frame data from signals which contain the CNAV message (L2C, L5).



The RAWCNAVFRAME log is not output by default. To receive this log, data decoding for L2C or L5 must be enabled using the **DATADECODESIGNAL** command (see page 111) for the specific signal.

**Message ID: 1066**

**Log Type: Asynch**

**Recommended Input:**

```
log rawcnavframea onnew
```

**ASCII Example:**

```
#RAWCNAVFRAMEA, COM1, 0, 63.0, SATTIME, 1902, 431718.000, 02000020, ee56, 13677  
;17, 6, 11, 8b18b8c892cd499a403d89d3a5bfc05f500a1fff6007dff412e017a3c029c  
cff5d6001fc9a70*0dddab32
```

| Field | Field type          | Description  | Format  | Binary Bytes | Binary Offset |
|-------|---------------------|--|---------|--------------|---------------|
| 1     | RAWCNAVFRAME header | Log header. See <i>Messages</i> on page 25 for more information. |         | H            | 0             |
| 2     | sigchannum          | Signal channel providing the bits                                | Ulong   | 4            | H             |
| 3     | PRN                 | Satellite PRN number   | Ulong   | 4            | H+4           |
| 4     | frameId             | frame ID   | Ulong   | 4            | H+8           |
| 5     | data                | Raw frame data   | Hex[38] | 38           | H+12          |
| 6     | xxxx                | 32-bit CRC (ASCII and Binary only)                               | Hex     | 4            | H+50          |
| 7     | [CR][LF]            | Sentence terminator (ASCII only)                                 | -       | -            | -             |



## 3.128 RAWEPHEM

### *Raw GPS ephemeris*

**Platform: OEM719, OEM729, OEM7500, OEM7700, OEM7720, PwrPak7, HxGN PIM7500**

This log contains the raw binary information for subframes one, two and three from the GPS satellite L1 C/A signal with the parity information removed. Each subframe is 240 bits long (10 words - 24 bits each) and the log contains a total 720 bits (90 bytes) of information (240 bits x 3 subframes). This information is preceded by the PRN number of the satellite from which it originated. This message is not generated unless all 10 words from all 3 frames have passed parity.

Ephemeris data whose Time of Ephemeris (TOE) is older than six hours is not shown. Multiple logs are output, one for each GPS satellite with collected ephemeris information.

**Message ID: 41**

**Log Type: Asynch**

**Recommended Input:**

```
log rawephema onnew
```

**ASCII Example:**

```
#RAWEPHEMA,COM1,15,60.5,FINESTEERING,1337,405297.175,02000000,97b7,1984;3,1337,403184,8b04e4818da44e50007b0d9c05ee664ffbfe695df763626f00001b03c6b3,8b04e4818e2b63060536608fd8cdaa051803a41261157ea10d2610626f3d,8b04e4818ead0006aa7f7ef8ffda25c1a69a14881879b9c6ffa79863f9f2*0bb16ac3
```

...

```
#RAWEPHEMA,COM1,0,60.5,SATTIME,1337,405390.000,02000000,97b7,1984;1,1337,410400,8b04e483f7244e50011d7a6105ee664ffbfe695df9e1643200001200aa92,8b04e483f7a9e1faab2b16a27c7d41fb5c0304794811f7a10d40b564327e,8b04e483f82c00252f57a782001b282027a31c0fba0fc525ffac84e10a06*c5834a5b
```



A way to use only one receiver and achieve better than 1 metre accuracy is to use precise orbit and clock files. Three types of GPS ephemeris, clock and earth orientation solutions are compiled by an elaborate network of GNSS receivers around the world all monitoring the satellite characteristics. IGS rapid orbit data is processed to produce files that correct the satellite clock and orbit parameters. Since there is extensive processing involved, these files are available on a delayed schedule from the US National Geodetic Survey at: [www.ngs.noaa.gov/orbits](http://www.ngs.noaa.gov/orbits)

Precise ephemeris files are available today to correct GPS data which was collected a few days ago. All you need is one GNSS receiver and a computer to process on. Replace the ephemeris data with the precise ephemeris data and post-process to correct range values.

| Field | Field type      | Description  | Format  | Binary Bytes | Binary Offset |
|-------|-----------------|--|---------|--------------|---------------|
| 1     | RAWEPHEM header | Log header. See <i>Messages</i> on page 25 for more information. |         | H            | 0             |
| 2     | PRN             | Satellite PRN number   | Ulong   | 4            | H             |
| 3     | ref week        | Ephemeris reference week number                                  | Ulong   | 4            | H+4           |
| 4     | ref secs        | Ephemeris reference time (s)                                     | Ulong   | 4            | H+8           |
| 5     | subframe1       | Subframe 1 data  | Hex[30] | 30           | H+12          |
| 6     | subframe2       | Subframe 2 data  | Hex[30] | 30           | H+42          |
| 7     | subframe3       | Subframe 3 data  | Hex[30] | 30           | H+72          |
| 8     | xxxx            | 32-bit CRC (ASCII and Binary only)                               | Hex     | 4            | H+102         |
| 9     | [CR][LF]        | Sentence terminator (ASCII only)                                 | -       | -            | -             |

## 3.129 RAWGPSSUBFRAME

### *Raw GPS subframe data*

**Platform: OEM719, OEM729, OEM7500, OEM7700, OEM7720, PwrPak7, HxGN PIM7500**

This log contains the raw GPS subframe data.

A raw GPS subframe is 300 bits in total. This includes the parity bits which are interspersed with the raw data ten times in six bit chunks, for a total of 60 parity bits. Note Field #5, below, has these 60 parity bits stripped out and only the raw subframe data remains, for a total of 240 bits.

**Message ID: 25**

**Log Type: Asynch**

**Recommended Input:**

```
log rawgpssubframea onnew
```

**ASCII Example:**

```
#RAWGPSSUBFRAMEA,COM1,59,62.5,SATTIME,1337,405348.000,02000000,f690,1984;2,22,4,8b04e483f3b17ee037a3732fe0fc8ccf074303ebdf2f6505f5aaaaaaaa9,2*41e768e4
```

...

```
#RAWGPSSUBFRAMEA,COM1,35,62.5,SATTIME,1337,405576.000,02000000,f690,1984;4,25,2,8b04e48406a8b9fe8b364d786ee827ff2f062258840ea4a10e20b964327e,4*52d460a7
```

...

```
#RAWGPSSUBFRAMEA,COM1,0,62.5,SATTIME,1337,400632.000,02000000,f690,1984;20,9,3,8b04e4826aadff3557257871000a26fc34a31d7a300bede5ffa3de7e06af,20*55d16a4a
```



The RAWGPSSUBFRAME log can be used to receive the data bits with the parity bits stripped out. Alternately, you can use the **RAWGPSWORD** log (see page 701) to receive the parity bits in addition to the data bits.

| Field | Field type            | Description  | Format | Binary Bytes | Binary Offset |
|-------|-----------------------|--|--------|--------------|---------------|
| 1     | RAWGPSSUBFRAME header | Log header. See <i>Messages</i> on page 25 for more information. |        | H            | 0             |
| 2     | decode #              | Frame decoder number   | Long   | 4            | H             |
| 3     | PRN                   | Satellite PRN number   | Ulong  | 4            | H+4           |
| 4     | subframe id           | Subframe ID  | Ulong  | 4            | H+8           |

---

| Field | Field type | Description   | Format  | Binary Bytes    | Binary Offset |
|-------|------------|---|---------|-----------------|---------------|
| 5     | data       | Raw subframe data                                   | Hex[30] | 32 <sup>1</sup> | H+12          |
| 6     | chan       | Signal channel number that the frame was decoded on | Ulong   | 4               | H+44          |
| 7     | xxxx       | 32-bit CRC (ASCII and Binary only)                  | Ulong   | 4               | H+48          |
| 8     | [CR][LF]   | Sentence terminator (ASCII only)                    | -       | -               | -             |

---

<sup>1</sup>In the binary log case, an additional 2 bytes of padding are added to maintain 4-byte alignment.

## 3.130 RAWGPSWORD

### *Raw GPS navigation word*

**Platform: OEM719, OEM729, OEM7500, OEM7700, OEM7720, PwrPak7, HxGN PIM7500**

This message contains the framed GPS raw navigation words. Each log contains a new 30 bit navigation word (in the least significant 30 bits), plus the last 2 bits of the previous word (in the most significant 2 bits). The 30 bit navigation word contains 24 bits of data plus 6 bits of parity. The GPS reference time stamp in the log header is the time the first bit of the 30 bit navigation word was received. Only navigation data that has passed parity checking appears in this log. One log appears for each PRN being tracked every 0.6 seconds if logged ONNEW or ONCHANGED.

**Message ID: 407**

**Log Type: Asynch**

**Recommended Input:**

```
log rawgpsworda onnew
```

**ASCII Example:**

```
#RAWGPSWORDA,COM1,0,58.5,FINESTEERING,1337,405704.473,02000000,9b16,1984;14,7ff9f5dc*8e7b8721
```

...

```
#RAWGPSWORDA,COM1,0,57.0,FINESTEERING,1337,405783.068,02000000,9b16,1984;1,93feff8a*6dd62c81
```

...

```
#RAWGPSWORDA,COM1,0,55.5,FINESTEERING,1337,405784.882,02000000,9b16,1984;5,fffff8ce*a948b4de
```



The RAWGPSWORD log can be used to receive the parity bits in addition to the data bits. Alternately, you can use the RAWGPSSUBFRAME log which already has the parity bits stripped out

| Field | Field type        | Description  | Format | Binary Bytes | Binary Offset |
|-------|-------------------|--|--------|--------------|---------------|
| 1     | RAWGPSWORD header | Log header. See <i>Messages</i> on page 25 for more information. |        | H            | 0             |
| 2     | PRN               | Satellite PRN number   | Ulong  | 4            | H             |
| 3     | nav word          | Raw navigation word  | Hex[4] | 4            | H+4           |
| 4     | xxxx              | 32-bit CRC (ASCII and Binary only)                               | Ulong  | 4            | H+8           |
| 5     | [CR][LF]          | Sentence terminator (ASCII only)                                 | -      | -            | -             |

## 3.131 RAWSBASFRAME

### *Raw SBAS frame data*

**Platform: OEM719, OEM729, OEM7500, OEM7700, OEM7720, PwrPak7, HxGN PIM7500**

This log contains the raw SBAS frame data of 226 bits (8-bit preamble, 6-bit message type and 212 bits of data but without a 24-bit CRC). Only frame data with a valid preamble and CRC are reported.

**Message ID: 973**

**Log Type: Asynch**

**Recommended Input:**

```
log rawsbasframea onnew
```

**ASCII Example:**

```
#RAWSBASFRAMEA,COM1,0,91.0,SATTIME,1610,341534.000,02000000,58e4,38637
;32,133,4,c6115ffc00000c009ffc07004c089ffdfdfdfdfdfdf957bbb6bffffc0,3
2*5afc5f95

#RAWSBASFRAMEA,COM1,0,91.0,SATTIME,1610,341535.000,02000000,58e4,38637
;32,133,2,53084007ff9fffffc03002c0000f0009ffc004005ffd6b961e39b9fb80,3
2*db5dfa62

#RAWSBASFRAMEA,COM1,0,91.0,SATTIME,1610,341535.000,02000000,58e4,38637
;35,135,2,53084007ff9fffffc03002c0000f0009ffc004005ffd6b961e39b9fb80,3
5*b72ff2a0

...

#RAWSBASFRAMEA,COM1,0,90.0,SATTIME,1610,341539.000,02000000,58e4,38637
;34,138,3,9a0c4000009ffc009ffdfdfc007fb9ffdfdfc0000040315b9bb96fb95680,3
4*cb050361
```



The RAWSBASFRAME log output contains all the raw data required for an application to compute its own SBAS correction parameters.

| Field | Field type          | Description  | Format | Binary Bytes | Binary Offset |
|-------|---------------------|--|--------|--------------|---------------|
| 1     | RAWSBASFRAME header | Log header. See <i>Messages</i> on page 25 for more information. |        | H            | 0             |
| 2     | decode #            | Frame decoder number   | Ulong  | 4            | H             |
| 3     | PRN                 | SBAS satellite PRN number  | Ulong  | 4            | H+4           |
| 4     | WAASmsg id          | SBAS frame ID  | Ulong  | 4            | H+8           |

---

| Field | Field type | Description   | Format  | Binary Bytes    | Binary Offset |
|-------|------------|---|---------|-----------------|---------------|
| 5     | data       | Raw SBAS frame data. There are 226 bits of data and 6 bits of padding | Hex[29] | 32 <sup>1</sup> | H+12          |
| 6     | chan       | Signal channel number that the frame was decoded on                   | Ulong   | 4               | H+44          |
| 7     | xxxx       | 32-bit CRC (ASCII and Binary only)                                    | Ulong   | 4               | H+48          |
| 8     | [CR][LF]   | Sentence terminator (ASCII only)                                      | -       | -               | -             |

---

<sup>1</sup>In the binary log case, an additional 3 bytes of padding are added to maintain 4-byte alignment.

## 3.132 RAWSBASFRAME2

### *Raw SBAS frame data 2*

**Platform: OEM719, OEM729, OEM7500, OEM7700, OEM7720, PwrPak7, HxGN PIM7500**

This log contains the raw SBAS frame data of 226 bits (8-bit preamble, 6-bit message type and 212 bits of data but without a 24-bit CRC). It also contains the transmitted frequency. Only frame data with a valid preamble and CRC are reported.

**Message ID: 2185**

**Log Type: Asynch**

**Recommended Input:**

```
log rawsbasframe2a onnew
```

**ASCII Example:**

```
#RAWSBASFRAME2A,COM1,0,77.5,SATTIME,1977,514394.000,02000020,b39f,3276
8;135,209,2,1,0,3,c60d4009ffc018001ffc005ffdfbf9ffc00bfed79db9bb9
5b9540*9a75ce69
```

```
#RAWSBASFRAME2A,COM1,0,77.5,SATTIME,1977,514394.000,02000020,b39f,3276
8;138,207,2,1,0,4,c6125ffdfc005fffffbfe3fb9ffdfdfdfdfdfba3956ab
ffffc0*9324a574
```

```
#RAWSBASFRAME2A,COM1,0,77.5,SATTIME,1977,514395.000,02000020,b39f,3276
8;135,208,1,0,0,4,53125ffdfc011ffc000007fe3fb5ffdfdfdfdfdfba3956ab
ffffc0*69490ac5
```

```
#RAWSBASFRAME2A,COM1,0,78.5,SATTIME,1977,514395.000,02000020,b39f,3276
8;138,206,1,0,0,3,530c7ff9ffc017ff9ffff9ffdfbf9fedffc003fe579db9bb9
5b9540*c7ca1531
```



The **RAWSBASFRAME2** log output contains all the raw data required for an application to compute its own SBAS correction parameters.

| Field | Field Type           | Description  | Format | Binary Bytes | Binary Offset |
|-------|----------------------|--|--------|--------------|---------------|
| 1     | RAWSBASFRAME2 header | Log header. See <i>Messages</i> on page 25 for more information. |        | H            | 0             |
| 2     | PRN                  | SBAS satellite PRN number  | Ulong  | 4            | H             |
| 3     | chan                 | Signal channel number that the frame was decoded on              | Ulong  | 4            | H+4           |



| Field | Field Type         | Description   | Format  | Binary Bytes    | Binary Offset |
|-------|--------------------|---|---------|-----------------|---------------|
| 4     | SBAS Signal Source | Identifies the source of the SBAS signal:<br>1 – SBASL1CA<br>2 – SBASL5I  | Uchar   | 1               | H+8           |
| 5     | SBAS Preamble Type | Identifies what preamble was used when tracking the SBAS signal:<br>0 – SBASL1CA 8-bit Preamble<br>1 – SBASL5I 8-bit Preamble | Uchar   | 1               | H+9           |
| 6     | Reserved           |   | Ushort  | 2               | H+10          |
| 7     | WAASmsg id         | SBAS frame ID   | Ulong   | 4               | H+12          |
| 8     | data               | Raw SBAS frame data. There are 226 bits of data and 6 bits of padding   | Hex[29] | 32 <sup>1</sup> | H+16          |
| 9     | xxxx               | 32-bit CRC (ASCII and Binary only)  | Ulong   | 4               | H+48          |
| 10    | [CR][LF]           | Sentence terminator (ASCII only)  | -       | -               | -             |

<sup>1</sup>In the binary log case, an additional 3 bytes of padding are added to maintain 4-byte alignment.

### 3.133 REFSTATION

#### *Base station position and health*

**Platform: OEM719, OEM729, OEM7500, OEM7700, OEM7720, PwrPak7, HxGN PIM7500**

This log contains the ECEF Cartesian position of the base station as received through the RTCMV3 message. It also features a time tag, the health status of the base station and the station ID. This information is set at the base station using the **FIX** command (see page 158) and the **DGPSTXID** command (see page 121). See *Figure 11: The WGS84 ECEF Coordinate System* on page 437 for a definition of the ECEF coordinates.

The base station health, Field #6, may be one of 8 values (0 to 7). Values 0 through 5 indicate the scale factor that is multiplied with the satellite UDRE one-sigma differential error values. Below are values 0 to 5 and their corresponding UDRE scale factors:

0: 1 (Health OK) 0.75 2: 0.5 3: 0.3 4: 0.2 5: 0.1

The base station health field only applies to RTCM base stations. A value of 6 means the base station transmission is not monitored and a value of 7 means that the base station is not working.

**Message ID: 175**

**Log Type: Asynch**

**Recommended Input:**

```
log refstationa onchanged
```

**ASCII Example:**

```
#REFSTATIONA,COM1,0,66.5,FINESTEERING,1364,490401.124,82000000,4e46,23
10;00000000,-1634532.443,-
3664608.907,4942482.713,0,RTCMV3,"AAAA"*1e2a0508
```

| Field | Field type        | Description   | Format | Binary Bytes | Binary Offset |
|-------|-------------------|---|--------|--------------|---------------|
| 1     | REFSTATION header | Log header. See <i>Messages</i> on page 25 for more information.                                    |        | H            | 0             |
| 2     | status            | Status of the base station information (see <i>Table 146: Base Station Status</i> on the next page) | Ulong  | 4            | H             |
| 3     | x                 | ECEF X value (m)  | Double | 8            | H+4           |
| 4     | y                 | ECEF Y value (m)  | Double | 8            | H+12          |
| 5     | z                 | ECEF Z value (m)  | Double | 8            | H+20          |
| 6     | health            | Base station health, see the description at the start of this section                               | Ulong  | 4            | H+28          |

| Field | Field type | Description   | Format  | Binary Bytes   | Binary Offset |
|-------|------------|---|---------|----------------|---------------|
| 7     | stn type   | Station type (see <i>Table 147: Station Type</i> below) | Enum    | 4              | H+32          |
| 8     | stn ID     | Base station ID   | Char[5] | 8 <sup>1</sup> | H+36          |
| 9     | xxxx       | 32-bit CRC (ASCII and Binary only)                      | Ulong   | 4              | H+44          |
| 10    | [CR][LF]   | Sentence terminator (ASCII only)                        | -       | -              | -             |

**Table 146: Base Station Status**

| Bit # | Mask       | Description                  | Bit = 0 | Bit = 1 |
|-------|------------|------------------------------|---------|---------|
| 0     | 0x00000001 | Validity of the base station | Valid   | Invalid |

**Table 147: Station Type**

| Base Station Type |          | Description              |
|-------------------|----------|--------------------------|
| Binary            | ASCII    |                          |
| 0                 | NONE     | Base station is not used |
| 1 - 3             | Reserved |                          |
| 4                 | RTCMV3   | Base station is RTCMV3   |



The REFSTATION log can be used for checking the operational status of a remotely located base station. You can verify that the base station is operating properly without traveling to it. This is especially useful for RTK work on long baselines.

<sup>1</sup>In the binary log case, an additional 3 bytes of padding are added to maintain 4-byte alignment.

## 3.134 REFSTATIONINFO

### *Base Station position information*

**Platform: OEM719, OEM729, OEM7500, OEM7700, OEM7720, PwrPak7, HxGN PIM7500**

This is an extended version of the REFSTATION log with latitude, longitude and ellipsoidal height of the base station in WGS84. In addition to the base station position, ARP height, antenna model name and antenna serial number are available if provided by the base station only through RTCMV3.

**Message ID: 1325**

**Log Type: Asynch**

**Recommended Input:**

```
log refstationinfoa onchanged
```

**ASCII Example:**

```
#REFSTATIONINFOA,USB1,0,89.5,EXACT,0,0.000,02000040,d38f,6782;  
51.116375174,-114.038254922,1048.502830628,WGS84,1.234,0,RTCMV3,  
"0","702GG","NVH05410007"*bedf8ece
```

| Field | Field type            | Description   | Format  | Binary Bytes   | Binary Offset |
|-------|-----------------------|---|---------|----------------|---------------|
| 1     | REFSTATIONINFO header | Log header. See <i>Messages</i> on page 25 for more information.                                | H       | 0              |               |
| 2     | latitude              | Latitude (degrees)  | Double  | 8              | H             |
| 3     | longitude             | Longitude (degrees)   | Double  | 8              | H+8           |
| 4     | height                | Ellipsoidal Height (m)  | Double  | 8              | H+16          |
| 5     | datum                 | Datum ID number (WGS84) (refer to <i>Table 28: Datum Transformation Parameters</i> on page 116) | Enum    | 4              | H+24          |
| 6     | ARP height            | Base Antenna ARP (m)  | Float   | 4              | H+28          |
| 7     | health                | Base Station Health, see <i>Table 146: Base Station Status</i> on the previous page             | Ulong   | 4              | H+32          |
| 8     | Ref Stn Type          | Base Station Type, see ( <i>Table 147: Station Type</i> on the previous page)                   | Enum    | 4              | H+36          |
| 9     | stn ID                | Base Station ID   | Char[5] | 8 <sup>a</sup> | H+40          |

<sup>a</sup>In the binary log case, an additional 3 bytes of padding are added to maintain 4-byte alignment.

---

| <b>Field</b> | <b>Field type</b> | <b>Description</b>                 | <b>Format</b> | <b>Binary Bytes</b> | <b>Binary Offset</b> |
|--------------|-------------------|------------------------------------|---------------|---------------------|----------------------|
| 10           | Ant Model         | Base Antenna Model Name            | Char<br>[32]  | 32                  | H+48                 |
| 11           | Ant Serial        | Base Antenna Serial Number         | Char<br>[32]  | 32                  | H+80                 |
| 12           | xxxx              | 32-bit CRC (ASCII and Binary only) | Ulong         | 4                   | H+112                |
| 13           | [CR][LF]          | Sentence terminator (ASCII only)   | -             | -                   | -                    |

## 3.135 ROVERPOS

### *Position using ALIGN*

**Platform: OEM719, OEM729, OEM7500, OEM7700, OEM7720, PwrPak7, HxGN PIM7500**

ALIGN generates distance and bearing information between a master and rover receiver. This log outputs the position information of the rover when using the ALIGN feature. This log can only be output from a Y ALIGN model and can be output at both Master and Rover ends.



You must have an ALIGN capable receiver to use this log.



- ALIGN is useful for obtaining the relative directional heading of a vessel/body, separation heading between two vessels/bodies, or heading information with moving base and pointing applications.
- The log can be output at the Y model Rover only if it is receiving the RTCAREFEXT message from the Master. The log can be output at any Master if the Master is receiving HEADINGEXTB from the Rover. Refer to the NovAtel application note [APN-048](#) for details on HEADINGEXT (available at [www.novatel.com/support/](http://www.novatel.com/support/)).
- ROVERPOS is dependent on the output frequency of the RTCAREFEXT message from the master to the rover.
- On dual antenna receivers, the ROVERPOS log is not available for the secondary antenna input

**Message ID: 1052**

**Log Type: Asynch**

**Recommended Input:**

```
log roverposa onchanged
```

**ASCII Example:**

```
#ROVERPOSA,COM1,0,21.5,FINESTEERING,1544,340322.000,02000008,7453,4655
;SOL_COMPUTED,NARROW_INT,51.11605565964,-114.03854655975,1055.8559,-
16.9000,WGS84,0.0130,0.0122,0.0206,"RRRR",0.0,0.0,13,12,12,11,0,0,0,0*
635b3a1c
```



Asynchronous logs, such as ROVERPOS, should only be logged ONCHANGED or ONNEW otherwise the most current data is not output when it is available. This is especially true of the ONTIME trigger, which may cause inaccurate time tags to result.

| Field | Field Type      | Description   | Format  | Binary Bytes | Binary Offset |
|-------|-----------------|---|---------|--------------|---------------|
| 1     | ROVERPOS header | Log header. See <i>Messages</i> on page 25 for more information.                        |         | H            | 0             |
| 2     | sol stat        | Solution Status, see <i>Table 73: Solution Status</i> on page 419                       | Enum    | 4            | H             |
| 3     | pos type        | Position Type see <i>Table 74: Position or Velocity Type</i> on page 420                | Enum    | 4            | H+4           |
| 4     | lat             | Rover WGS84 Latitude in degrees   | Double  | 8            | H+8           |
| 5     | long            | Rover WGS84 Longitude in degrees  | Double  | 8            | H+16          |
| 6     | hgt             | Rover MSL Height in metres  | Double  | 8            | H+24          |
| 7     | undulation      | Undulation in metres  | Float   | 4            | H+32          |
| 8     | datum id#       | WGS84 (default) (refer to <i>Table 28: Datum Transformation Parameters</i> on page 116) | Enum    | 4            | H+36          |
| 9     | lat $\sigma$    | Latitude standard deviation in metres   | Float   | 4            | H+40          |
| 10    | long $\sigma$   | Longitude standard deviation in metres  | Float   | 4            | H+44          |
| 11    | hgt $\sigma$    | Height standard deviation in metres   | Float   | 4            | H+48          |
| 12    | stn id          | Rover ID (default = "RRRR")   | Char[4] | 4            | H+52          |
| 13    | Reserved        |   | Float   | 4            | H+56          |
| 14    | Reserved        |   | Float   | 4            | H+60          |
| 15    | #SVs            | Number of satellite tracked   | Uchar   | 1            | H+64          |
| 16    | #solnSVs        | Number of satellite in solution   | Uchar   | 1            | H+65          |
| 17    | #obs            | Number of satellites above elevation mask angle   | Uchar   | 1            | H+66          |
| 18    | #multi          | Number of satellites above the mask angle with L2, B2                                   | Uchar   | 1            | H+67          |
| 19    | Reserved        |   | Hex     | 1            | H+68          |
| 20    |                 |   | Uchar   | 1            | H+69          |
| 21    |                 |   | Uchar   | 1            | H+70          |
| 22    |                 |   | Uchar   | 1            | H+71          |
| 23    | xxxx            | 32-bit CRC (ASCII and Binary only)  | Hex     | 1            | H+72          |
| 24    | [CR][LF]        | Sentence Terminator (ASCII only)  | -       | -            | -             |

## 3.136 RTCMV3 Standard Logs

**Platform: OEM719, OEM729, OEM7500, OEM7700, OEM7720, PwrPak7, HxGN PIM7500**

NovAtel's RTCMV3 logs are implementations of the messages described by the RTCM SC-104 committee's "Differential GNSS (Global Navigation Satellite Systems) Services – Version 3" standard. These messages are primarily intended to support RTK operations. They are also an alternative raw data format to NovAtel's proprietary messages.

The RTCMV3 logs can be divided into several categories that are described below. An RTK base station must minimally transmit one or more observable message, together with one or more station and antenna message. The **GENERATERTKCORRECTIONS** command on page 178 illustrates an appropriate set of messages and is an easy way to configure logging.

### Example Input:

```
interfacemode com2 none RTCMV3
fix position 51.1136 -114.0435 1059.4
thisantennatype NOV702
log com2 rtcml006 ontime 10
log com2 rtcml033 ontime 10 2
log com2 rtcml004 ontime 1
log com2 rtcml012 ontime 1
```

### 3.136.1 Legacy Observable Messages

The legacy observable messages contain GPS and GLONASS code and phase observables. The *extended* messages additionally contain the C/N0.

**Table 148: Legacy Observable Messages**

| Log Name | Message ID | Description                               |
|----------|------------|---|
| RTCM1001 | 772        | GPS L1-only observables, basic            |
| RTCM1002 | 774        | GPS L1-only observables, extended         |
| RTCM1003 | 776        | GPS L1/L2 basic observables, basic        |
| RTCM1004 | 770        | GPS L1/L2 basic observables, extended     |
| RTCM1009 | 885        | GLONASS L1-only observables, basic        |
| RTCM1010 | 887        | GLONASS L1-only observables, extended     |
| RTCM1011 | 889        | GLONASS L1/L2 basic observables, basic    |
| RTCM1012 | 891        | GLONASS L1/L2 basic observables, extended |



### 3.136.2 MSM Observable Messages

The Multiple Signal Messages (MSM) are observable messages for all current GNSS systems. They provide a standardized framework for message content and are designed to support future systems and signals.



Sending legacy (1001-1004 and 1009-1012) and MSM messages in the same stream can cause problems for remote RTK users and is not recommended.

Each GNSS system has a set of seven MSM types numbered from 1 to 7. The MSM type for each GNSS system provides the same generic information. Generally, as the MSM number increases, more information is available in the messages. For example, MSM1 for each GNSS system provides the code measurements for the system, while MSM3 provides both the code and phase. The information encoded in each MSM variant is described in *Table 149: MSM Type Descriptions* below for the descriptions of each of the seven MSM types. For RTK operations, MSM3 is minimally recommended.

**Table 149: MSM Type Descriptions**

| Message | Description  |
|---------|--|
| MSM1    | Provides the code measurements.  |
| MSM2    | Provides the phase measurements.   |
| MSM3    | Provides the data from MSM1 (code) and MSM2 (phase) in a single message.                 |
| MSM4    | Provides all the data from MSM3 (code and phase) and adds the CNR measurements.          |
| MSM5    | Provides all the data from MSM4 (code, phase and CNR) and adds the doppler measurements. |
| MSM6    | Provides the same information as MSM4, but has extended resolution on the measurements.  |
| MSM7    | Provides the same information as MSM5, but has extended resolution on the measurements.  |

*Table 150: MSM Log Names* below lists the MSM message name and *Table 151: MSM Message IDs* on the next page lists the message IDs.

**Table 150: MSM Log Names**

| Message | GPS      | GLONASS  | Galileo  | QZSS     | BeiDou   |
|---------|----------|----------|----------|----------|----------|
| MSM1    | RTCM1071 | RTCM1081 | RTCM1091 | RTCM1111 | RTCM1121 |
| MSM2    | RTCM1072 | RTCM1082 | RTCM1092 | RTCM1112 | RTCM1122 |
| MSM3    | RTCM1073 | RTCM1083 | RTCM1093 | RTCM1113 | RTCM1123 |

| Message | GPS      | GLONASS  | Galileo  | QZSS     | BeiDou   |
|---------|----------|----------|----------|----------|----------|
| MSM4    | RTCM1074 | RTCM1084 | RTCM1094 | RTCM1114 | RTCM1124 |
| MSM5    | RTCM1075 | RTCM1085 | RTCM1095 | RTCM1115 | RTCM1125 |
| MSM6    | RTCM1076 | RTCM1086 | RTCM1096 | RTCM1116 | RTCM1126 |
| MSM7    | RTCM1077 | RTCM1087 | RTCM1097 | RTCM1117 | RTCM1127 |

Table 151: MSM Message IDs

| Message | GPS  | GLONASS | Galileo | QZSS | BeiDou |
|---------|------|---------|---------|------|--------|
| MSM1    | 1472 | 1479    | 1486    | 1648 | 1592   |
| MSM2    | 1473 | 1480    | 1487    | 1649 | 1593   |
| MSM3    | 1474 | 1481    | 1488    | 1650 | 1594   |
| MSM4    | 1475 | 1482    | 1489    | 1651 | 1595   |
| MSM5    | 1476 | 1483    | 1490    | 1652 | 1596   |
| MSM6    | 1477 | 1484    | 1491    | 1653 | 1597   |
| MSM7    | 1478 | 1485    | 1492    | 1654 | 1598   |

### 3.136.3 Station and Antenna Messages

The station and antenna messages listed in *Table 152: Station and Antenna Messages* on the next page provide the base station's coordinates and hardware. Remote RTK users require this information so that they can position themselves relative to a base station.

- Message Type 1005 provides the Earth-Centered, Earth-Fixed (ECEF) coordinates of the Antenna Reference Point (ARP). The ARP is an explicit physical point on the antenna, typically the center of its base. It is related to the antenna phase center from where the measurements are emitted via the Phase Center Offsets (PCOs). The PCOs can be set using the **THISANTENNAPCO** command (see page 359) or **THISANTENNATYPE** command (see page 361). If the PCOs are not set, then the coordinates transmitted by Message types 1005 and 1006 will be those that the receiver is fixed to by the **FIX** command (see page 158).
- Message Type 1006 is the same as 1005 but additionally provides the antenna height. This value is always set to zero by the receiver firmware.
- Message Type 1007 provides the base station antenna type. Conventionally, the antenna name from the International GNSS Service (IGS) is used. The antenna name can be set using the **THISANTENNATYPE** command (see page 361).
- Message Type 1008 is the same as 1007 but additionally provides the antenna serial number. The serial number is always set to null by the receiver firmware.
- Message Type 1033, like message types 1007 and 1008, also provides the antenna information. Message type 1033 additionally provides the receiver type and firmware version. The primary use of this information is to more-easily enable RTK rovers to fix their GLONASS

ambiguities. This information is filled automatically and appropriately by the receiver firmware.

For a receiver operating as an RTK base station, the recommended messages to transmit are 1006 and 1033. With these messages remote RTK users have all the information describing the base station.

**Table 152: Station and Antenna Messages**

| Log Name | Message ID | RTCM Message Type | Description  |
|----------|------------|-------------------|--|
| RTCM1005 | 765        | 1005              | Stationary RTK Base Station Antenna Reference Point (ARP)        |
| RTCM1006 | 768        | 1006              | Stationary RTK Base Station ARP with Antenna Height              |
| RTCM1007 | 852        | 1007              | Extended Antenna Descriptor and Setup Information                |
| RTCM1008 | 854        | 1008              | Extended Antenna Reference Station Description and Serial Number |
| RTCM1033 | 1097       | 1033              | Receiver and antenna descriptors                                 |

### 3.136.4 Ephemeris Messages

The ephemeris messages listed in *Table 153: Ephemeris Messages* below provide the satellite ephemerides. For RTK operations this information is optional, as RTK rovers will be downloading their own ephemerides directly from the satellites.

There are two messages for each ephemeris type. For the messages logged ONTIME (e.g. LOG RTCM1019 ONTIME 10) a single satellite's ephemeris is output at each ONTIME interval. The ephemerides will be cycled through in numerical order. For the messages logged ONCHANGED (e.g., LOG RTCM1019ASYNC ONCHANGED), new or changed ephemerides will be output as soon as they are available.

**Table 153: Ephemeris Messages**

| Log Name      | Message ID | RTCM Message Type | Description                           |
|---------------|------------|-------------------|---------------------------------------|
| RTCM1019      | 893        | 1019              | GPS Ephemerides, logged ONTIME        |
| RTCM1019ASYNC | 2088       | 1019              | GPS Ephemerides, logged ONCHANGED     |
| RTCM1020      | 895        | 1020              | GLONASS Ephemerides, logged ONTIME    |
| RTCM1020ASYNC | 2089       | 1020              | GLONASS Ephemerides, logged ONCHANGED |
| RTCM1042      | 2171       | 1042              | BeiDou Ephemerides, logged ONTIME     |
| RTCM1042ASYNC | 2170       | 1042              | BeiDou Ephemerides, logged ONCHANGED  |
| RTCM1044      | 2177       | 1044              | QZSS Ephemerides, logged ONTIME       |

---

| <b>Log Name</b> | <b>Message ID</b> | <b>RTCM Message Type</b> | <b>Description</b>                          |
|-----------------|-------------------|--------------------------|---|
| RTCM1044ASYNC   | 2176              | 1044                     | QZSS Ephemerides, logged ONCHANGED          |
| RTCM1045        | 2173              | 1045                     | Galileo F/NAV Ephemerides, logged ONTIME    |
| RTCM1045ASYNC   | 2172              | 1045                     | Galileo F/NAV Ephemerides, logged ONCHANGED |
| RTCM1046        | 2175              | 1046                     | Galileo I/NAV Ephemerides, logged ONTIME    |
| RTCM1046ASYNC   | 2174              | 1046                     | Galileo I/NAV Ephemerides, logged ONCHANGED |

## 3.137 RTKASSISTSTATUS

### *RTK ASSIST status*

**Platform: OEM719, OEM729, OEM7500, OEM7700, OEM7720, PwrPak7, HxGN PIM7500**

This log provides information on the state of RTK ASSIST.

RTK ASSIST operates in two modes: coast and full assist. The RTKASSISTSTATUS log reports which mode is currently available. Coast mode is available as soon as the RTK ASSIST corrections are received from the L-Band satellite, while full assist mode requires a convergence period. In coast mode, position error growth during RTK correction outages is slightly worse than in full assist mode and RTK will not resume following a full signal outage until after RTK corrections are restored. Full assist gives the lowest position error growth during RTK correction outages, and makes it possible for RTK to resume even if there are complete GNSS signal outages during the RTK ASSIST period.

The RTK ASSIST ACTIVE state reported in the RTKASSISTSTATUS log is also reported in the RTKPOS and BESTPOS extended solution status field. See *Table 77: Extended Solution Status* on page 423.

The RTKASSISTSTATUS log reports the time remaining in the RTK ASSIST ACTIVE state. Once RTK ASSIST becomes active, the remaining time will count down from the time out set by the **RTKASSISTTIMEOUT** command (see page 293) .

The corrections age reported in the RTKASSISTSTATUS log should typically be below 30 seconds. If the age exceeds this value, then L-Band tracking is likely being degraded. The most likely cause of degraded L-Band tracking are obstructions between the antenna and the L-Band satellite.

**Message ID: 2048**

**Log Type: Synch**

**Recommended Input:**

```
log rtkassiststatusa ontime 5
```

**ASCII Example:**

```
#RTKASSISTSTATUSA,COM1,0,80.0,FINESTEERING,1932,491359.000,02000020,80fe,46672;ACTIVE,ASSIST,969.0,14.0*26e32616
```

| Field | Field type             | Description  | Format | Binary Bytes | Binary Offset |
|-------|------------------------|--|--------|--------------|---------------|
| 1     | RTKASSISTSTATUS header | Log header. See <i>Messages</i> on page 25 for more information. |        | H            | 0             |
| 2     | State                  | State:<br>INACTIVE (0)<br>ACTIVE (1)                             | Enum   | 4            | H             |

| Field | Field type      | Description   | Format | Binary Bytes | Binary Offset |
|-------|-----------------|---|--------|--------------|---------------|
| 3     | Mode            | Mode:<br>UNAVAILABLE (0)<br>COAST (1)<br>ASSIST (2)                         | Enum   | 4            | H+4           |
| 4     | Remaining time  | Time remaining in seconds   | Float  | 4            | H+8           |
| 5     | Corrections age | Age of the RTK ASSIST corrections in seconds. Maximum value of 120 seconds. | Float  | 4            | H+12          |
| 6     | xxxx            | 32-bit CRC (ASCII and Binary only)  | Hex    | 4            | H+16          |
| 7     | [CR][LF]        | Sentence terminator (ASCII only)  | -      | -            | -             |

## 3.138 RTKDOP

### *DOP values from the RTK fast filter*

**Platform: OEM719, OEM729, OEM7500, OEM7700, OEM7720, PwrPak7, HxGN PIM7500**

This log contains the DOP values calculated by the RTK fast filter.

The RTKDOP log contains single-point DOPs, calculated using only the satellites used in the fast RTK solution, that is, those used for the RTKPOS position. Calculation of the RTK DOPs are limited to once a second.

The calculation of the RTK DOP is different than that for the pseudorange DOP. In the pseudorange filter, new DOPs are calculated every 60 seconds. The RTK DOP is calculated at the rate requested and regardless of a change in satellites. However, the DOP is only calculated when the RTKDOP log is requested.

**Message ID: 952**

**Log Type: Synch**

**Recommended Input:**

```
log rtkdopa ontime 10
```

**ASCII Example:**

```
#RTKDOPA,COM1,0,60.0,FINESTEERING,1449,446982.000,02000008,b42b,3044;2
.3386,1.9856,0.9407,1.5528,1.2355,10.0,11,21,58,6,7,10,16,18,24,26,29,
41*85f8338b
```

| Field | Field type                               | Description  | Format | Binary Bytes | Binary Offset |
|-------|--|--|--------|--------------|---------------|
| 1     | RTKDOP header                            | Log header. See <i>Messages</i> on page 25 for more information. |        | H            | 0             |
| 2     | GDOP                                     | Geometric DOP  | Float  | 4            | H             |
| 3     | PDOP                                     | Position DOP   | Float  | 4            | H+4           |
| 4     | HDOP                                     | Horizontal DOP   | Float  | 4            | H+8           |
| 5     | HTDOP                                    | Horizontal and Time DOP  | Float  | 4            | H+12          |
| 6     | TDOP                                     | Time DOP   | Float  | 4            | H+16          |
| 7     | elev mask                                | GPS elevation mask angle   | Float  | 4            | H+20          |
| 8     | #sats                                    | Number of satellites to follow                                   | Ulong  | 4            | H+24          |
| 9     | sats                                     | Satellites in use at time of calculation                         | Ulong  | 4            | H+28          |
| 10    | Next satellite offset = H+28+(#sats * 4) |  |        |              |               |

---

| <b>Field</b> | <b>Field type</b> | <b>Description</b>                 | <b>Format</b> | <b>Binary Bytes</b> | <b>Binary Offset</b> |
|--------------|-------------------|------------------------------------|---------------|---------------------|----------------------|
| 11           | xxxx              | 32-bit CRC (ASCII and Binary only) | Ulong         | 4                   | H+28+<br>(#sats * 4) |
| 12           | [CR][LF]          | Sentence terminator (ASCII only)   | -             | -                   | -                    |



## 3.139 RTKDOP2

### *DOP values from the RTK low latency filter*

**Platform: OEM719, OEM729, OEM7500, OEM7700, OEM7720, PwrPak7, HxGN PIM7500**

This log is similar to the RTKDOP log, but contains the per-system TDOPs.

**Message ID: 1172**

**Log Type: Synch**

**Recommended Input:**

```
log rtkdop2a ontime 10
```

**ASCII Example:**

```
#RTKDOP2A,COM1,0,80.0,FINESTEERING,1690,601478.000,02000008,ab50,43488;1.5000,1.1850,0.6580,0.9850,2,GPS,0.6530,GLONASS,0.6490*c5f1a25f
```

| Field | Field type                                  | Description  | Format | Binary Bytes | Binary Offset           |
|-------|---|--|--------|--------------|-------------------------|
| 1     | RTKDOP2 header                              | Log header. See <i>Messages</i> on page 25 for more information. |        | H            | 0                       |
| 2     | GDOP  | Geometric DOP  | Float  | 4            | H                       |
| 3     | PDOP  | Position DOP   | Float  | 4            | H+4                     |
| 4     | HDOP  | Horizontal DOP   | Float  | 4            | H+8                     |
| 5     | VDOP  | Vertical DOP   | Float  | 4            | H+12                    |
| 6     | #systems                                    | Number of entries to follow                                      | Ulong  | 4            | H+16                    |
| 7     | system                                      | See <i>Table 64: System Used for Timing</i> on page 345          | Enum   | 4            | H+20                    |
| 8     | TDOP  | Time DOP (Dilution of Precision)                                 | Float  | 4            | H+24                    |
| 9     | Next satellite offset = H+20+(#systems * 8) |  |        |              |                         |
| 10    | xxxx  | 32-bit CRC (ASCII and Binary only)                               | Hex    | 4            | H+20+<br>(#systems * 8) |
| 11    | [CR][LF]                                    | Sentence terminator (ASCII only)                                 | -      | -            | -                       |

## 3.140 RTKPOS

### *RTK low latency position data*

**Platform: OEM719, OEM729, OEM7500, OEM7700, OEM7720, PwrPak7, HxGN PIM7500**

This log contains the low latency RTK position computed by the receiver, along with two status flags. In addition, it reports other status indicators, including differential age, which is useful in predicting anomalous behavior brought about by outages in differential corrections. This log is recommended for kinematic operation. Better accuracy can be obtained in static operation with the **MATCHEDPOS** log (see page 576).

With the system operating in an RTK mode, this log reflects if the solution is a good RTK low latency solution (from extrapolated base station measurements) or invalid. A valid RTK low latency solution is computed for up to 60 seconds after reception of the last base station observation. The degradation in accuracy, due to differential age, is reflected in the standard deviation fields, and is summarized in the [Standards and References](#) section of our website [www.novatel.com/support/](http://www.novatel.com/support/). See also the **DGPSTXID** command (see page 121).



The RTK system in the receiver provides two kinds of position solutions. The Matched RTK position is computed with buffered observations, so there is no error due to the extrapolation of base station measurements. This provides the highest accuracy solution possible at the expense of some latency which is affected primarily by the speed of the differential data link. The **MATCHEDPOS** log (see page 576) contains the matched RTK solution and can be generated for each processed set of base station observations.

The Low-Latency RTK position is computed from the latest local observations and extrapolated base station observations. This supplies a valid RTK position with the lowest latency possible at the expense of some accuracy. The degradation in accuracy is reflected in the standard deviation and is summarized in [An Introduction to GNSS](#) available on our website. The amount of time that the base station observations are extrapolated is in the "differential age" field of the position log. The Low-Latency RTK system extrapolates for 60 seconds. The **RTKPOS** log contains the Low-Latency RTK position when valid, and an "invalid" status when a Low-Latency RTK solution could not be computed. The **BESTPOS** log (see page 416) contains either the low-latency RTK, PPP or pseudorange-based position, whichever has the smallest standard deviation.

**Message ID: 141**

**Log Type: Synch**

**Recommended Input:**

```
log rtkposa ontime 1
```

**ASCII Example:**

```
#RTKPOSA, COM1, 0, 54.5, FINESTEERING, 1419, 340040.000, 02000040, 176e, 2724;S  
OL_COMPUTED, NARROW_INT, 51.11635911294, -114.03833103654, 1063.8336, -  
16.2712, WGS84, 0.0179, 0.0096, 0.0174, "AAAA", 1.000, 0.000, 12, 11, 11, 11, 0, 01  
, 0, 33*0adb3e47
```



Consider the case of a racing car, on a closed circuit, requiring RTK operation. In this situation, you would have to send live data to the pits using a radio link.

RTK operation enables live centimeter level position accuracy. When answers are required in the field, the base station must transmit information to the rover in real-time. For RTK operation, extra equipment such as radios are required to transmit and receive this information. The base station has a corresponding base radio and the rover station has a corresponding rover radio.

Post-processing can provide post-mission position and velocity data using raw GNSS data collected from the car. The logs necessary for post-processing include:

```
RANGECMPB ONTIME 1
RAWEPHEMB ONNEW
```

These are examples of data collection for post-processing, and real-time operation. OEM7-based output is compatible with post-processing software from the NovAtel's Waypoint Products Group or refer to our website at [www.novatel.com](http://www.novatel.com) for more details.

| Field | Field type    | Description  | Format | Binary Bytes | Binary Offset |
|-------|---------------|--|--------|--------------|---------------|
| 1     | RTKPOS header | Log header. See <i>Messages</i> on page 25 for more information.   |        | H            | 0             |
| 2     | sol status    | Solution status (see <i>Table 73: Solution Status</i> on page 419)   | Enum   | 4            | H             |
| 3     | pos type      | Position type (see <i>Table 74: Position or Velocity Type</i> on page 420)   | Enum   | 4            | H+4           |
| 4     | lat           | Latitude (degrees)   | Double | 8            | H+8           |
| 5     | lon           | Longitude (degrees)  | Double | 8            | H+16          |
| 6     | hgt           | Height above mean sea level (m)  | Double | 8            | H+24          |
| 7     | undulation    | Undulation - the relationship between the geoid and the WGS84 ellipsoid (m)<br><br><div style="border: 1px solid black; padding: 5px; width: fit-content; margin: 10px auto;">  When using a datum other than WGS84, the undulation value also includes the vertical shift due to differences between the datum in use and WGS84. </div> | Float  | 4            | H+32          |
| 8     | datum id#     | Datum ID number (see <i>Table 28: Datum Transformation Parameters</i> on page 116)   | Enum   | 4            | H+36          |
| 9     | lat $\sigma$  | Latitude standard deviation (m)  | Float  | 4            | H+40          |
| 10    | lon $\sigma$  | Longitude standard deviation (m)   | Float  | 4            | H+44          |

| Field | Field type                  | Description   | Format  | Binary Bytes | Binary Offset |
|-------|-----------------------------|---|---------|--------------|---------------|
| 11    | hgt $\sigma$                | Height standard deviation (m)   | Float   | 4            | H+48          |
| 12    | stn id                      | Base station ID   | Char[4] | 4            | H+52          |
| 13    | diff_age                    | Differential age in seconds   | Float   | 4            | H+56          |
| 14    | sol_age                     | Solution age in seconds   | Float   | 4            | H+60          |
| 15    | #SVs                        | Number of satellites tracked  | Uchar   | 1            | H+64          |
| 16    | #solnSVs                    | Number of satellites vehicles used in solution  | Uchar   | 1            | H+65          |
| 17    | #ggL1                       | Number of satellites with L1/E1/B1 signals used in solution   | Uchar   | 1            | H+66          |
| 18    | #solnMultiSVs               | Number of satellites with multi-frequency signals used in solution  | Uchar   | 1            | H+67          |
| 19    | Reserved                    |   | Hex     | 1            | H+68          |
| 20    | ext sol stat                | Extended solution status (see <i>Table 77: Extended Solution Status</i> on page 423)                        | Hex     | 1            | H+69          |
| 21    | Galileo and BeiDou sig mask | Galileo and BeiDou signals used mask (see <i>Table 76: Galileo and BeiDou Signal-Used Mask</i> on page 423) | Hex     | 1            | H+70          |
| 22    | GPS and GLONASS sig mask    | GPS and GLONASS signals used mask (see <i>Table 75: GPS and GLONASS Signal-Used Mask</i> on page 422)       | Hex     | 1            | H+71          |
| 23    | xxxx                        | 32-bit CRC (ASCII and Binary only)  | Hex     | 4            | H+72          |
| 24    | [CR][LF]                    | Sentence terminator (ASCII only)  | -       | -            | -             |

## 3.141 RTKSATS

### *Satellites used in RTKPOS solution*

**Platform: OEM719, OEM729, OEM7500, OEM7700, OEM7720, PwrPak7, HxGN PIM7500**

This log lists the used and unused satellites for the corresponding RTKPOS solution. It also describes the signals of the used satellites and reasons for exclusions.

**Message ID: 1174**

**Log Type: Synch**

**Recommended Input:**

```
log rtkstats ontime 1
```

**Abbreviated ASCII Example:**

```
<RTKSATS COM1 0 60.5 FINESTEERING 1728 524924.000 02000000 95e7 11487
< 24
< GPS 3 GOOD 00000003
< GPS 5 GOOD 00000003
...
< GPS 23 GOOD 00000003
< GPS 30 GOOD 00000003
< GLONASS 1+1 GOOD 00000003
< GLONASS 2-4 GOOD 00000003
...
< GLONASS 20+2 GOOD 00000003
< GLONASS 21+4 GOOD 00000003
< BEIDOU 6 GOOD 00000003
< BEIDOU 11 GOOD 00000003
...
< BEIDOU 12 GOOD 00000003
< BEIDOU 13 GOOD 00000003
```

| Field | Field type     | Description  | Format | Binary Bytes | Binary Offset |
|-------|----------------|--|--------|--------------|---------------|
| 1     | RTKSATS header | Log header. See <i>Messages</i> on page 25 for more information.           |        | H            | 0             |
| 2     | #entries       | Number of records to follow  | Ulong  | 4            | H             |
| 3     | system         | Satellite system (refer to <i>Table 102: Satellite System</i> on page 532) | Enum   | 4            | H+4           |
| 4     | Satellite ID   | Satellite identifiers  | Ulong  | 4            | H+8           |

| Field | Field type                              | Description   | Format | Binary Bytes | Binary Offset       |
|-------|---|---|--------|--------------|---------------------|
| 5     | Status                                  | Satellite status. See <i>Table 79: Observation Statuses</i> on page 426   | Enum   | 4            | H+12                |
| 6     | Signal mask                             | See <i>Table 80: BESTSATS GPS Signal Mask</i> on page 427, <i>Table 81: BESTSATS GLONASS Signal Mask</i> on page 428, <i>Table 82: BESTSATS Galileo Signal Mask</i> on page 428, and <i>Table 83: BESTSATS BeiDou Signal Mask</i> on page 428 | Hex    | 4            | H+16                |
| 7     | Next satellite offset = H+4+(#sat x 16) |   |        |              |                     |
| 8     | xxxx                                    | 32-bit CRC (ASCII and Binary only)  | Hex    | 4            | H+4+<br>(#sat x 16) |
| 9     | [CR][LF]                                | Sentence terminator (ASCII only)  | -      | -            | -                   |

## 3.142 RTKVEL

### *RTK velocity*

**Platform: OEM719, OEM729, OEM7500, OEM7700, OEM7720, PwrPak7, HxGN PIM7500**

This log contains the RTK velocity information computed by the receiver. In addition, it reports a velocity status indicator that is useful in indicating whether or not the corresponding data is valid and differential age is useful in predicting anomalous behavior brought about by outages in differential corrections. The velocity measurements sometimes have a latency associated with them. The time of validity is the time tag in the log minus the latency value.



Velocities from the RTK filter are calculated from the delta-position. In RTKVEL, the velocity type is the same as the position type.



In an RTKVEL log, the actual speed and direction of the receiver antenna over ground is provided. The receiver does not determine the direction a vessel, craft or vehicle is pointed (heading) but rather the direction of motion of the GNSS antenna relative to ground.

With the system operating in an RTK mode, this log reflects if the solution is a good RTK low latency solution (from extrapolated base station measurements) or invalid. A valid RTK low latency solution is computed for up to 60 seconds after reception of the last base station observation.

The velocity is computed from consecutive RTK low latency updates. As such, it is an average velocity based on the time difference between successive position computations and not an instantaneous velocity at the RTKVEL time tag. The velocity latency to be subtracted from the time tag is normally half the time between filter updates. Under default operation, the RTK low latency filter is updated at a rate of 2 Hz. This translates into a velocity latency of 0.25 seconds. The latency can be reduced by increasing the update rate of the RTK low latency filter by requesting the BESTVEL, RTKVEL, BESTPOS or RTKPOS messages at a rate higher than 2 Hz. For example, a logging rate of 10 Hz would reduce the velocity latency to 0.05 seconds. For integration purposes, the velocity latency should be applied to the record time tag.

**Message ID: 216**

**Log Type: Synch**

**Recommended Input:**

```
log rtkvela ontime 1
```

**ASCII Example:**

```
#RTKVELA,COM1,0,43.5,FINESTEERING,1364,496137.000,02100000,71e2,2310;S  
OL_COMPUTED,NARROW_  
INT,0.250,1.000,0.0027,207.645811,0.0104,0.0*f551cc42
```



Consider the case of an unmanned aircraft. A base station must send differential correction data to the remote aircraft. In this type of application, the aircraft's radio may pass the differential solution, for example RTKVEL, to the positioning system so it can process it and generate precise position information for the flight controls.

| Field | Field type    | Description   | Format | Binary Bytes | Binary Offset |
|-------|---------------|---|--------|--------------|---------------|
| 1     | RTKVEL header | Log header. See <i>Messages</i> on page 25 for more information.  |        | H            | 0             |
| 2     | sol status    | Solution status, see <i>Table 73: Solution Status</i> on page 419   | Enum   | 4            | H             |
| 3     | vel type      | Velocity type, see <i>Table 74: Position or Velocity Type</i> on page 420   | Enum   | 4            | H+4           |
| 4     | latency       | A measure of the latency in the velocity time tag in seconds. It should be subtracted from the time to give improved results                          | Float  | 4            | H+8           |
| 5     | age           | Differential age in seconds   | Float  | 4            | H+12          |
| 6     | hor spd       | Horizontal speed over ground, in metres per second  | Double | 8            | H+16          |
| 7     | trk gnd       | Actual direction of motion over ground (track over ground) with respect to True North, in degrees   | Double | 8            | H+24          |
| 8     | vert spd      | Vertical speed, in metres per second, where positive values indicate increasing altitude (up) and negative values indicate decreasing altitude (down) | Double | 8            | H+32          |
| 9     | Reserved      |   | Float  | 4            | H+40          |
| 10    | xxxx          | 32-bit CRC (ASCII and Binary only)  | Ulong  | 4            | H+44          |
| 11    | [CR]<br>[LF]  | Sentence terminator (ASCII only)  | -      | -            | -             |



## 3.143 RTKXYZ

### *RTK Cartesian position and velocity*

**Platform: OEM719, OEM729, OEM7500, OEM7700, OEM7720, PwrPak7, HxGN PIM7500**

This log contains the receiver's low latency position and velocity in ECEF coordinates. The position and velocity status fields indicate whether or not the corresponding data is valid. See *Figure 11: The WGS84 ECEF Coordinate System* on page 437 for a definition of the ECEF coordinates.

The velocity measurements have a latency associated with them. The time of validity is the time tag in the log minus the latency value.

With the system operating in an RTK mode, this log reflects if the solution is a good RTK low latency solution (from extrapolated base station measurements) or invalid. A valid RTK low latency solution is computed for up to 60 seconds after reception of the last base station observation. The degradation in accuracy due to differential age is reflected in the standard deviation fields, and is summarized in the [Standards and References](#) section of our website [www.novatel.com/support/](http://www.novatel.com/support/). See also the **DGPSTXID** command (see page 121).

The velocity is computed from consecutive RTK low latency updates. As such, it is an average velocity based on the time difference between successive position computations and not an instantaneous velocity at the RTKVEL time tag. The velocity latency to be subtracted from the time tag is normally half the time between filter updates. Under default operation, the RTK low latency filter is updated at a rate of 2 Hz. This translates into a velocity latency of 0.25 seconds. The latency can be reduced by increasing the update rate of the RTK low latency filter by requesting the BESTXYZ message at a rate higher than 2 Hz. For example, a logging rate of 10 Hz would reduce the velocity latency to 0.05 seconds. For integration purposes, the velocity latency should be applied to the record time tag.

See also the **BESTXYZ** log on page 435 and **MATCHEDXYZ** log on page 581.

**Message ID: 244**

**Log Type: Synch**

**Recommended Input:**

```
log rtkxyza ontime 1
```

**ASCII Example:**

```
#RTKXYZA,COM1,0,56.0,FINESTEERING,1419,340041.000,02000040,3d88,2724;S
OL_COMPUTED,NARROW_INT,-1634531.5666,-
3664618.0291,4942496.3230,0.0099,0.0219,0.0115,SOL_COMPUTED,NARROW_
INT,0.0030,0.0003,-
0.0016,0.0198,0.0438,0.0230,"AAAA",0.250,1.000,0.000,12,11,11,11,0,01,
0,33*0497d146
```

| Field | Field type    | Description  | Format  | Binary Bytes | Binary Offset |
|-------|---------------|--|---------|--------------|---------------|
| 1     | RTKXYZ header | Log header. See <i>Messages</i> on page 25 for more information.   |         | H            | 0             |
| 2     | P-sol status  | Solution status, see <i>Table 73: Solution Status</i> on page 419  | Enum    | 4            | H             |
| 3     | pos type      | Position type, see <i>Table 74: Position or Velocity Type</i> on page 420  | Enum    | 4            | H+4           |
| 4     | P-X           | Position X-coordinate (m)  | Double  | 8            | H+8           |
| 5     | P-Y           | Position Y-coordinate (m)  | Double  | 8            | H+16          |
| 6     | P-Z           | Position Z-coordinate (m)  | Double  | 8            | H+24          |
| 7     | P-X $\sigma$  | Standard deviation of P-X (m)  | Float   | 4            | H+32          |
| 8     | P-Y $\sigma$  | Standard deviation of P-Y (m)  | Float   | 4            | H+36          |
| 9     | P-Z $\sigma$  | Standard deviation of P-Z (m)  | Float   | 4            | H+40          |
| 10    | V-sol status  | Solution status, see <i>Table 73: Solution Status</i> on page 419  | Enum    | 4            | H+44          |
| 11    | vel type      | Velocity type, see <i>Table 74: Position or Velocity Type</i> on page 420  | Enum    | 4            | H+48          |
| 12    | V-X           | Velocity vector along X-axis (m)   | Double  | 8            | H+52          |
| 13    | V-Y           | Velocity vector along Y-axis (m)   | Double  | 8            | H+60          |
| 14    | V-Z           | Velocity vector along Z-axis (m)   | Double  | 8            | H+68          |
| 15    | V-X $\sigma$  | Standard deviation of V-X (m)  | Float   | 4            | H+76          |
| 16    | V-Y $\sigma$  | Standard deviation of V-Y (m)  | Float   | 4            | H+80          |
| 17    | V-Z $\sigma$  | Standard deviation of V-Z (m)  | Float   | 4            | H+84          |
| 18    | stn ID        | Base station identification  | Char[4] | 4            | H+88          |
| 19    | V-latency     | A measure of the latency in the velocity time tag in seconds. It should be subtracted from the time to give improved results | Float   | 4            | H+92          |
| 20    | diff_age      | Differential age in seconds  | Float   | 4            | H+96          |
| 21    | sol_age       | Solution age in seconds  | Float   | 4            | H+100         |
| 22    | #SVs          | Number of satellites tracked   | Uchar   | 1            | H+104         |
| 23    | #solnSVs      | Number of satellite vehicles used in solution  | Uchar   | 1            | H+105         |

| Field | Field type                  | Description   | Format | Binary Bytes | Binary Offset |
|-------|-----------------------------|---|--------|--------------|---------------|
| 24    | #ggL1                       | Number of satellites with L1/E1/B1 signals used in solution   | Uchar  | 1            | H+106         |
| 25    | #solnMultiSVs               | Number of satellites with multi-frequency signals used in solution  | Uchar  | 1            | H+107         |
| 26    | Reserved                    |   | Char   | 1            | H+108         |
| 27    | ext sol stat                | Extended solution status (see <i>Table 77: Extended Solution Status</i> on page 423)                        | Hex    | 1            | H+109         |
| 28    | Galileo and BeiDou sig mask | Galileo and BeiDou signals used mask (see <i>Table 76: Galileo and BeiDou Signal-Used Mask</i> on page 423) | Hex    | 1            | H+110         |
| 29    | GPS and GLONASS sig mask    | GPS and GLONASS signals used mask (see <i>Table 75: GPS and GLONASS Signal-Used Mask</i> on page 422)       | Hex    | 1            | H+111         |
| 30    | xxxx                        | 32-bit CRC (ASCII and Binary only)  | Ulong  | 4            | H+112         |
| 31    | [CR][LF]                    | Sentence terminator (ASCII only)  | -      | -            | -             |

## 3.144 RXCONFIG

### *Receiver configuration*

**Platform: OEM719, OEM729, OEM7500, OEM7700, OEM7720, PwrPak7, HxGN PIM7500**

This log is used to output a list of all current command settings. When requested, an RXCONFIG log is output for each setting. See also the **LOGLIST** log on page 564 for a list of currently active logs. One log is output for each current command.

**Message ID: 128**

**Log Type: Collection**

**Recommended Input:**

```
log rxconfiga once
```

**ASCII Example<sup>1</sup>:**

```
#RXCONFIGA, COM1, 71, 47.5, APPROXIMATE, 1337, 333963.260, 02000000, f702, 1984;
#ADJUST1PPSA, COM1, 71, 47.5, APPROXIMATE, 1337, 333963.260, 02000000, f702, 19
84; OFF, ONCE, 0*ba85a20b*91f89b07
#RXCONFIGA, COM1, 70, 47.5, APPROXIMATE, 1337, 333963.398, 02000000, f702, 1984;
#ANTENNAPOWERA, COM1, 70, 47.5, APPROXIMATE, 1337, 333963.398, 02000000, f702, 1
984; ON*d12f6135*8f8741be
#RXCONFIGA, COM1, 69, 47.5, APPROXIMATE, 1337, 333963.455, 02000000, f702, 1984;
#CLOCKADJUSTA, COM1, 69, 47.5, APPROXIMATE, 1337, 333963.455, 02000000, f702, 1
984; ENABLE*0af36d92*b13280f2
...
#RXCONFIGA, COM1, 7, 47.5, APPROXIMATE, 1337, 333966.781, 02000000, f702, 1984;
#STATUSCONFIGA, COM1, 7, 47.5, APPROXIMATE, 1337, 333966.781, 02000000, f702, 1
984; CLEAR, AUX2, 0*a6141e28*d0bba9f2
#RXCONFIGA, COM1, 2, 47.5, APPROXIMATE, 1337, 333967.002, 02000000, f702, 1984;
#SBASECUTOFFA, COM1, 2, 47.5, APPROXIMATE, 1337, 333967.002, 02000000, f702, 19
84; -5.000000000*b9b11096*2e8b77cf
#RXCONFIGA, COM1, 1, 47.5, FINESTEERING, 1337, 398382.787, 02000000, f702, 1984;
#LOGA, COM1, 1, 47.5, FINESTEERING, 1337, 398382.787, 02000000, f702, 1984; COM1
, MARKPOSA, ONNEW, 0.000000, 0.000000, NOHOLD*a739272d*6692c084
```

<sup>1</sup>The embedded CRCs are flipped to make the embedded messages recognizable to the receiver. For example, consider the first embedded message above.

**91f89b07: 10010001111110001001101100000111  
11100000110110010001111110001001:e0d91f89**

The CRC is really **e0d91f89**.

```
#RXCONFIGA,COM1,0,47.5,FINESTEERING,1337,400416.370,02000000,f702,1984;
#LOGA,COM1,0,47.5,FINESTEERING,1337,400416.370,02000000,f702,1984;COM2
,PASSCOM2A,ONCHANGED,0.000000,0.000000,NOHOLD*55fc0c62*17086d18
```



Do not use undocumented commands or logs! Doing so may produce errors and void your warranty.



The RXCONFIG log can be used to ensure your receiver is correctly setup for your application.

| Field | Field type      | Description  | Format | Binary Bytes | Binary Offset |
|-------|-----------------|--|--------|--------------|---------------|
| 1     | RXCONFIG header | Log header. See <i>Messages</i> on page 25 for more information.   | -      | H            | 0             |
| 2     | e header        | Embedded header  | -      | h            | H             |
| 3     | e msg           | Embedded message   | Varied | a            | H+h           |
| 4     | e xxxx          | Embedded (inverted) 32-bit CRC (ASCII and Binary only). The embedded CRC is inverted so that the receiver does not recognize the embedded messages as messages to be output but continues with the RXCONFIG message. If you wish to use the messages output from the RXCONFIG log, simply flip the embedded CRC around for individual messages | Ulong  | 4            | H+h+a         |
| 5     | xxxx            | 32-bit CRC (ASCII and Binary only)   | Hex    | 4            | H+h+a+4       |
| 6     | [CR][LF]        | Sentence terminator (ASCII only)   | -      | -            | -             |

## 3.145 RXSTATUS

### *Receiver status*

**Platform: OEM719, OEM729, OEM7500, OEM7700, OEM7720, PwrPak7, HxGN PIM7500**

This log conveys various status parameters of the GNSS receiver system. These include the Receiver Status and Error words which contain several flags specifying status and error conditions. If an error occurs (shown in the Receiver Error word), the receiver idles all channels, turns off the antenna and disables the RF hardware as these conditions are considered to be fatal errors. The log contains a variable number of status words to allow for maximum flexibility and future expansion.

The receiver gives the user the ability to determine the importance of the status bits. In the case of the Receiver Status, setting a bit in the priority mask causes the condition to trigger an error. This causes the receiver to idle all channels, turn off the antenna and disable the RF hardware, the same as if a bit in the Receiver Error word is set. Setting a bit in an Auxiliary Status priority mask causes that condition to set the bit in the Receiver Status word corresponding to that Auxiliary Status. See also the **STATUSCONFIG** command on page 354.



Field #4, the receiver status word as represented in *Table 155: Receiver Status* on page 739, is also in Field #8 of the header. See the ASCII Example below and *Table 155: Receiver Status* on page 739 for clarification.

Refer also to the chapter on *Built-In Status Tests* in the [OEM7 Installation and Operation User Manual](#).

**Message ID: 93**

**Log Type: Asynch**

**Recommended Input:**

```
log rxstatusa onchanged
```

**Abbreviated ASCII Example:**

```
#RXSTATUS COM1 0 90.5 FINESTEERING 1740 232531.278 02000020 2AE1 44913
00000000 4 (Receiver Error)
02000020 00000000 00000000 00000000 (Receiver Status)
00040080 00001008 00000000 00000000 (Aux1 Status)
00000000 00000000 00000000 00000000 (Aux2 Status)
02000000 00000000 00000000 00000000 (Aux3 Status)
00000000 00000000 00000000 00000000 (Aux4 Status)
```



Receiver errors automatically generate event messages. These event messages are output in RXSTATUSEVENT logs. It is also possible to have status conditions trigger event messages to be generated by the receiver. This is done by setting/clearing the appropriate bits in the event set/clear masks. The set mask tells the receiver to generate an event message when the bit becomes set. Likewise, the clear mask causes messages to be generated when a bit is cleared. See the **STATUSCONFIG** command on page 354 for details.

If you wish to disable all these messages without changing the bits, simply UNLOG the **RXSTATUSEVENT** logs on the appropriate ports. See the **UNLOG** command on page 376.

| Field | Field type      | Description   | Format | Binary Bytes | Binary Offset |
|-------|-----------------|---|--------|--------------|---------------|
| 1     | RXSTATUS header | Log header. See <i>Messages</i> on page 25 for more information.  |        | H            | 0             |
| 2     | error           | Receiver error (see <i>Table 154: Receiver Error</i> on page 737). A value of zero indicates no errors  | Ulong  | 4            | H             |
| 3     | # stats         | Number of status codes (including Receiver Status). Each status code consists of 4 fields, the status, priority mask, event set mask and event clear mask. Each set is repeated for each status type.<br><br>Note that for clarity, the Receiver Status, Auxiliary1 Status, Auxiliary 2 Status and Auxiliary3 Status is listed separately in this message | Ulong  | 4            | H+4           |
| 4     | rxstat          | Receiver status word (see <i>Table 155: Receiver Status</i> on page 739)  | Ulong  | 4            | H+8           |
| 5     | rxstat pri      | Receiver status priority mask, which can be set using the <b>STATUSCONFIG</b> command on page 354   | Ulong  | 4            | H+12          |
| 6     | rxstat set      | Receiver status event set mask, which can be set using the <b>STATUSCONFIG</b> command on page 354  | Ulong  | 4            | H+16          |
| 7     | rxstat clear    | Receiver status event clear mask, which can be set using the <b>STATUSCONFIG</b> command on page 354  | Ulong  | 4            | H+20          |
| 8     | aux1stat        | Auxiliary 1 status word (see <i>Table 157: Auxiliary 1 Status</i> on page 741)  | Ulong  | 4            | H+24          |

| Field | Field type     | Description   | Format | Binary Bytes | Binary Offset |
|-------|----------------|---|--------|--------------|---------------|
| 9     | aux1stat pri   | Auxiliary 1 status priority mask, which can be set using the <b>STATUSCONFIG</b> command on page 354    | Ulong  | 4            | H+28          |
| 10    | aux1stat set   | Auxiliary 1 status event set mask, which can be set using the <b>STATUSCONFIG</b> command on page 354   | Ulong  | 4            | H+32          |
| 11    | aux1stat clear | Auxiliary 1 status event clear mask, which can be set using the <b>STATUSCONFIG</b> command on page 354 | Ulong  | 4            | H+36          |
| 12    | aux2stat       | Auxiliary 2 status word (see <i>Table 158: Auxiliary 2 Status</i> on page 743)                          | Ulong  | 4            | H+40          |
| 13    | aux2stat pri   | Auxiliary 2 status priority mask, which can be set using the <b>STATUSCONFIG</b> command on page 354    | Ulong  | 4            | H+44          |
| 14    | aux2stat set   | Auxiliary 2 status event set mask, which can be set using the <b>STATUSCONFIG</b> command on page 354   | Ulong  | 4            | H+48          |
| 15    | aux2stat clear | Auxiliary 2 status event clear mask, which can be set using the <b>STATUSCONFIG</b> command on page 354 | Ulong  | 4            | H+52          |
| 16    | aux3stat       | Auxiliary 3 status word (see <i>Table 159: Auxiliary 3 Status</i> on page 745)                          | Ulong  | 4            | H+56          |
| 17    | aux3stat pri   | Auxiliary 3 status priority mask, which can be set using the <b>STATUSCONFIG</b> command on page 354    | Ulong  | 4            | H+60          |
| 18    | aux3stat set   | Auxiliary 3 status event set mask, which can be set using the <b>STATUSCONFIG</b> command on page 354   | Ulong  | 4            | H+64          |
| 19    | aux3stat clear | Auxiliary 3 status event clear mask, which can be set using the <b>STATUSCONFIG</b> command on page 354 | Ulong  | 4            | H+68          |
| 20    | aux4stat       | Auxiliary 4 status word (see <i>Table 161: Auxiliary 4 Status</i> on page 747)                          | Ulong  | 4            | H+72          |
| 21    | aux4stat pri   | Auxiliary 4 status priority mask, which can be set using the <b>STATUSCONFIG</b> command on page 354    | Ulong  | 4            | H+76          |



| Field | Field type     | Description   | Format | Binary Bytes | Binary Offset |
|-------|----------------|---|--------|--------------|---------------|
| 22    | aux4stat set   | Auxiliary 4 status event set mask, which can be set using the <b>STATUSCONFIG</b> command on page 354   | Ulong  | 4            | H+80          |
| 23    | aux4stat clear | Auxiliary 4 status event clear mask, which can be set using the <b>STATUSCONFIG</b> command on page 354 | Ulong  | 4            | H+84          |
| 24    | xxxx           | 32-bit CRC (ASCII and Binary only)  | Ulong  | 4            | H+88          |
| 25    | [CR][LF]       | Sentence terminator (ASCII only)  | -      | -            | -             |

Table 154: Receiver Error

| Nibble | Bit | Mask       | Description   | Bit = 0 | Bit = 1 |
|--------|-----|------------|---|---------|---------|
| N0     | 0   | 0x00000001 | Dynamic Random Access Memory (DRAM) status<br>RAM failure on an OEM7 card may also be indicated by a flashing red LED.                  | OK      | Error   |
|        | 1   | 0x00000002 | Invalid firmware  | OK      | Error   |
|        | 2   | 0x00000004 | ROM status  | OK      | Error   |
|        | 3   | 0x00000008 | Reserved  |         |         |
| N1     | 4   | 0x00000010 | Electronic Serial Number (ESN) access status  | OK      | Error   |
|        | 5   | 0x00000020 | Authorization code status   | OK      | Error   |
|        | 6   | 0x00000040 | Reserved  |         |         |
|        | 7   | 0x00000080 | Supply voltage status   | OK      | Error   |
| N2     | 8   | 0x00000100 | Reserved  |         |         |
|        | 9   | 0x00000200 | Temperature status (as compared against acceptable limits)  | OK      | Error   |
|        | 10  | 0x00000400 | MINOS status  | OK      | Error   |
|        | 11  | 0x00000800 | PLL RF status. Error with an RF PLL. See AUX2 status bits ( <i>Table 158: Auxiliary 2 Status</i> on page 743) for individual PLL status | OK      | Error   |

| Nibble | Bit | Mask       | Description                     | Bit = 0 | Bit = 1 |
|--------|-----|------------|---------------------------------|---------|---------|
| N3     | 12  | 0x00001000 | Reserved                        |         |         |
|        | 13  | 0x00002000 |                                 |         |         |
|        | 14  | 0x00004000 |                                 |         |         |
|        | 15  | 0x00008000 | NVM status                      | OK      | Error   |
| N4     | 16  | 0x00010000 | Software resource lim exceeded  | OK      | Error   |
|        | 17  | 0x00020000 | Model invalid for this receiver | OK      | Error   |
|        | 18  | 0x00040000 | Reserved                        |         |         |
|        | 19  | 0x00080000 |                                 |         |         |
| N5     | 20  | 0x00100000 | Remote loading has begun        | No      | Yes     |
|        | 21  | 0x00200000 | Export restriction              | OK      | Error   |
|        | 22  | 0x00400000 | Safe Mode                       | OK      | Error   |
|        | 23  | 0x00800000 | Reserved                        |         |         |
| N6     | 24  | 0x01000000 |                                 |         |         |
|        | 25  | 0x02000000 |                                 |         |         |
|        | 26  | 0x04000000 |                                 |         |         |
|        | 27  | 0x08000000 |                                 |         |         |
| N7     | 28  | 0x10000000 |                                 |         |         |
|        | 29  | 0x20000000 |                                 |         |         |
|        | 30  | 0x40000000 |                                 |         |         |
|        | 31  | 0x80000000 | Component hardware failure      | OK      | Error   |

**Table 155: Receiver Status**

| Nibble | Bit | Mask       | Description  | Bit = 0               | Bit = 1                    |
|--------|-----|------------|--|-----------------------|----------------------------|
| N0     | 0   | 0x00000001 | Error flag, see <i>Table 154: Receiver Error</i> on page 737   | No error              | Error                      |
|        | 1   | 0x00000002 | Temperature status   | Within specifications | Warning                    |
|        | 2   | 0x00000004 | Voltage supply status  | OK                    | Warning                    |
|        | 3   | 0x00000008 | Primary antenna power status<br>See the <b>ANTENNAPOWER</b> command on page 64   | Powered               | Not powered                |
| N1     | 4   | 0x00000010 | LNA Failure  | OK                    | Failure                    |
|        | 5   | 0x00000020 | Primary antenna open circuit flag<br>This flag is only available on certain products.  | OK                    | Open, antenna disconnected |
|        | 6   | 0x00000040 | Primary antenna short circuit flag<br>This flag is only available on certain products.   | OK                    | Short circuit detected     |
|        | 7   | 0x00000080 | CPU overload flag<br>This flag is only available on certain products.  | No overload           | Overload                   |
| N2     | 8   | 0x00000100 | COM port transmit buffer overrun.<br>See AUX2 status bits ( <i>Table 158: Auxiliary 2 Status</i> on page 743) for individual COM port status   | OK                    | COM buffer overrun         |
|        | 9   | 0x00000200 | Reserved   |                       |                            |
|        | 10  | 0x00000400 |  |                       |                            |
|        | 11  | 0x00000800 | Link overrun flag<br>This flag indicates if any of the USB, ICOM, CCOM, NCOM, XCOM or File ports are overrun. See AUX1, AUX2 and AUX3 status bits ( <i>Table 157: Auxiliary 1 Status</i> on page 741, <i>Table 158: Auxiliary 2 Status</i> on page 743 or <i>Table 159: Auxiliary 3 Status</i> on page 745) for the specific port for which the buffer is overrun. | No overrun            | Overrun                    |

| Nibble | Bit | Mask       | Description  | Bit = 0   | Bit = 1              |
|--------|-----|------------|--|---|----------------------|
| N3     | 12  | 0x00001000 | Input overrun flag<br>This flag is set if any of the receiver ports (COM, USB, ICOM, NCOM or XCOM) experience an input overrun.  | No overrun  | Overrun              |
|        | 13  | 0x00002000 | Aux transmit overrun flag  | No overrun  | Overrun              |
|        | 14  | 0x00004000 | AGC out of range<br>See the AUX1 status bits ( <i>Table 157: Auxiliary 1 Status</i> on the next page) for individual AGC status. | OK  | Out of range         |
|        | 15  | 0x00008000 | Jammer Detected.<br>See the AUX1 status bits ( <i>Table 157: Auxiliary 1 Status</i> on the next page) for individual RF status   | OK  | Jammer Detected      |
| N4     | 16  | 0x00010000 | INS reset flag   | No INS reset  | INS reset            |
|        | 17  | 0x00020000 | IMU communication failure  | No error  | No IMU communication |
|        | 18  | 0x00040000 | GPS almanac flag/UTC known   | Valid   | Invalid              |
|        | 19  | 0x00080000 | Position solution flag   | Valid   | Invalid              |
| N5     | 20  | 0x00100000 | Position fixed flag, see the <b>FIX</b> command on page 158  | Not fixed   | Fixed                |
|        | 21  | 0x00200000 | Clock steering status  | Enabled   | Disabled             |
|        | 22  | 0x00400000 | Clock model flag   | Valid   | Invalid              |
|        | 23  | 0x00800000 | External oscillator locked flag  | Unlocked  | Locked               |
| N6     | 24  | 0x01000000 | Software resource  | OK  | Warning              |
|        | 25  | 0x06000000 | Version bit 0  | See <i>Table 156: Version Bits</i> on the next page |                      |
|        | 26  |            | Version bit 1  | See <i>Table 156: Version Bits</i> on the next page |                      |
|        | 27  | 0x08000000 | Tracking mode  | Normal tracking                                     | HDR tracking         |
| N7     | 28  | 0x10000000 | Digital Filtering Enabled  | Disabled  | Enabled              |
|        | 29  | 0x20000000 | Auxiliary 3 status event flag  | No event  | Event                |
|        | 30  | 0x40000000 | Auxiliary 2 status event flag  | No event  | Event                |
|        | 31  | 0x80000000 | Auxiliary 1 status event flag  | No event  | Event                |

**Table 156: Version Bits**

| Bit 25 | Bit 26 | Description   |
|--------|--------|---|
| 0      | 0      | Interpret Status/Error Bits as OEM6 or earlier format |
| 1      | 0      | Interpret Status/Error Bits as OEM7 format            |
| 0      | 1      | Reserved for a future version                         |
| 1      | 1      | Reserved for a future version                         |

**Table 157: Auxiliary 1 Status**

| Nibble | Bit | Mask       | Description              | Bit = 0    | Bit = 1         |
|--------|-----|------------|--------------------------|------------|-----------------|
| N0     | 0   | 0x00000001 | Jammer detected on RF1   | OK         | Jammer detected |
|        | 1   | 0x00000002 | Jammer detected on RF2   | OK         | Jammer detected |
|        | 2   | 0x00000004 | Jammer detected on RF3   | OK         | Jammer detected |
|        | 3   | 0x00000008 | Position averaging       | Off        | On              |
| N1     | 4   | 0x00000010 | Jammer detected on RF4   | OK         | Jammer detected |
|        | 5   | 0x00000020 | Jammer detected on RF5   | OK         | Jammer detected |
|        | 6   | 0x00000040 | Jammer detected on RF6   | OK         | Jammer detected |
|        | 7   | 0x00000080 | USB connection status    | Connected  | Not connected   |
| N2     | 8   | 0x00000100 | USB1 buffer overrun flag | No overrun | Overrun         |
|        | 9   | 0x00000200 | USB2 buffer overrun flag | No overrun | Overrun         |
|        | 10  | 0x00000400 | USB3 buffer overrun flag | No overrun | Overrun         |
|        | 11  | 0x00000800 | Reserved                 |            |                 |

| Nibble | Bit | Mask       | Description                  | Bit = 0    | Bit = 1       |
|--------|-----|------------|------------------------------|------------|---------------|
| N3     | 12  | 0x00001000 | Profile Activation Bit       | OK         | Error         |
|        | 13  | 0x00002000 | Throttled Ethernet Reception | OK         | Throttled     |
|        | 14  | 0x00004000 | RF1 AGC out of range         | OK         | Out of range  |
|        | 15  | 0x00008000 | RF2 AGC out of range         | OK         | Out of range  |
| N4     | 16  | 0x00010000 | RF3 AGC out of range         | OK         | Out of range  |
|        | 17  | 0x00020000 | RF4 AGC out of range         | OK         | Out of range  |
|        | 18  | 0x00040000 | Ethernet not connected       | Connected  | Not connected |
|        | 19  | 0x00080000 | ICOM1 buffer overrun flag    | No overrun | Overrun       |
| N5     | 20  | 0x00100000 | ICOM2 buffer overrun flag    | No overrun | Overrun       |
|        | 21  | 0x00200000 | ICOM3 buffer overrun flag    | No overrun | Overrun       |
|        | 22  | 0x00400000 | NCOM1 buffer overrun flag    | No overrun | Overrun       |
|        | 23  | 0x00800000 | NCOM2 buffer overrun flag    | No overrun | Overrun       |
| N6     | 24  | 0x01000000 | NCOM3 buffer overrun flag    | No overrun | Overrun       |
|        | 25  | 0x02000000 | XCOM1 buffer overrun flag    | No overrun | Overrun       |
|        | 26  | 0x04000000 | XCOM2 buffer overrun flag    | No overrun | Overrun       |
|        | 27  | 0x08000000 | XCOM3 buffer overrun flag    | No overrun | Overrun       |

| Nibble | Bit | Mask       | Description  | Bit = 0 | Bit = 1          |
|--------|-----|------------|--|---------|------------------|
| N7     | 28  | 0x10000000 | RF5 AGC out of range   | OK      | Out of range     |
|        | 29  | 0x20000000 | RF6 AGC out of range   | OK      | Out of range     |
|        | 30  | 0x40000000 | Reserved   |         |                  |
|        | 31  | 0x80000000 | IMU measurement outlier detected. Indicates when the SPAN system has detected an outlier in the IMU performance. May be treated as a notice unless the issue persists. | OK      | Outlier detected |

**Table 158: Auxiliary 2 Status**

| Nibble | Bit | Mask       | Description                            | Bit = 0    | Bit = 1        |
|--------|-----|------------|--|------------|----------------|
| N0     | 0   | 0x00000001 | SPI Communication Failure              | OK         | Error          |
|        | 1   | 0x00000002 | I <sup>2</sup> C Communication Failure | OK         | Error          |
|        | 2   | 0x00000004 | COM4 buffer overrun flag               | No overrun | Buffer Overrun |
|        | 3   | 0x00000008 | COM5 buffer overrun flag               | No overrun | Buffer Overrun |
| N1     | 4   | 0x00000010 | Reserved                               |            |                |
|        | 5   | 0x00000020 | Reserved                               |            |                |
|        | 6   | 0x00000040 | Reserved                               |            |                |
|        | 7   | 0x00000080 | Reserved                               |            |                |
| N2     | 8   | 0x00000100 | Reserved                               |            |                |
|        | 9   | 0x00000200 | COM1 buffer overrun flag               | OK         | Buffer Overrun |
|        | 10  | 0x00000400 | COM2 buffer overrun flag               | OK         | Buffer Overrun |
|        | 11  | 0x00000800 | COM3 buffer overrun flag               | OK         | Buffer Overrun |
| N3     | 12  | 0x00001000 | PLL RF1 unlock flag                    | OK         | PLL Unlock     |
|        | 13  | 0x00002000 | PLL RF2 unlock flag                    | OK         | PLL Unlock     |
|        | 14  | 0x00004000 | PLL RF3 unlock flag                    | OK         | PLL Unlock     |
|        | 15  | 0x00008000 | PLL RF4 unlock flag                    | OK         | PLL Unlock     |

| Nibble | Bit | Mask       | Description  | Bit = 0 | Bit = 1                       |
|--------|-----|------------|--|---------|-------------------------------|
| N4     | 16  | 0x00010000 | PLL RF5 unlock flag  | OK      | PLL Unlock                    |
|        | 17  | 0x00020000 | PLL RF6 unlock flag  | OK      | PLL Unlock                    |
|        | 18  | 0x00040000 | CCOM1 buffer overrun   | OK      | Buffer Overrun                |
|        | 19  | 0x00080000 | CCOM2 buffer overrun   | OK      | Buffer Overrun                |
| N5     | 20  | 0x00100000 | CCOM3 buffer overrun   | OK      | Buffer Overrun                |
|        | 21  | 0x00200000 | CCOM4 buffer overrun   | OK      | Buffer Overrun                |
|        | 22  | 0x00400000 | CCOM5 buffer overrun   | OK      | Buffer Overrun                |
|        | 23  | 0x00800000 | CCOM6 buffer overrun   | OK      | Buffer Overrun                |
| N6     | 24  | 0x01000000 | ICOM4 buffer overrun   | OK      | Buffer Overrun                |
|        | 25  | 0x02000000 | ICOM5 buffer overrun   | OK      | Buffer Overrun                |
|        | 26  | 0x04000000 | ICOM6 buffer overrun   | OK      | Buffer Overrun                |
|        | 27  | 0x08000000 | ICOM7 buffer overrun   | OK      | Buffer Overrun                |
| N7     | 28  | 0x10000000 | Secondary antenna power status<br>See the <b>ANTENNAPOWER</b><br>command (see page 64) | Powered | Not Powered                   |
|        | 29  | 0x20000000 | Secondary antenna open circuit<br>This flag is only available on certain<br>products   | OK      | Open, antenna<br>disconnected |
|        | 30  | 0x40000000 | Secondary antenna short circuit<br>This flag is only available on certain<br>products  | OK      | Short circuit<br>detected     |
|        | 31  | 0x80000000 | Reset loop detected  | OK      | Reset Detected                |



**Table 159: Auxiliary 3 Status**

| Nibble | Bit | Mask       | Description  | Bit = 0   | Bit = 1 |
|--------|-----|------------|--|---|---------|
| N0     | 0   | 0x00000001 | SCOM buffer overrun flag.<br>This flag is set if any of the SCOM ports (SCOM1 – SCOM4) experience overrun. | No overrun  | Overrun |
|        | 1   | 0x00000002 | WCOM1 buffer overrun flag  | No overrun  | Overrun |
|        | 2   | 0x00000004 | FILE buffer overrun flag   | No overrun  | Overrun |
|        | 3   | 0x00000008 | Reserved   |   |         |
| N1     | 4   | 0x00000010 | Antenna 1 Gain State   | <i>Table 160: Antenna Gain State on the next page</i> |         |
|        | 5   | 0x00000020 |  |   |         |
|        | 6   | 0x00000040 | Antenna 2 Gain State   | <i>Table 160: Antenna Gain State on the next page</i> |         |
|        | 7   | 0x00000080 |  |   |         |
| N2     | 8   | 0x00000100 | Reserved   |   |         |
|        | 9   | 0x00000200 |  |   |         |
|        | 10  | 0x00000400 |  |   |         |
|        | 11  | 0x00000800 |  |   |         |
| N3     | 12  | 0x00001000 | Reserved   |   |         |
|        | 13  | 0x00002000 |  |   |         |
|        | 14  | 0x00004000 |  |   |         |
|        | 15  | 0x00008000 |  |   |         |
| N4     | 16  | 0x00010000 | Reserved   |   |         |
|        | 17  | 0x00020000 |  |   |         |
|        | 18  | 0x00040000 |  |   |         |
|        | 19  | 0x00080000 |  |   |         |

<sup>1</sup>Some bits are only active when the corresponding modules are active. For example, the BT Pairing bit will not show 1 = device not paired unless the Bluetooth module is enabled.

| Nibble | Bit | Mask       | Description                                 | Bit = 0       | Bit = 1                       |
|--------|-----|------------|---|---------------|-------------------------------|
| N5     | 20  | 0x00100000 | Reserved                                    |               |                               |
|        | 21  | 0x00200000 |   |               |                               |
|        | 22  | 0x00400000 |   |               |                               |
|        | 23  | 0x00800000 |   |               |                               |
| N6     | 24  | 0x01000000 | Reserved                                    |               |                               |
|        | 25  | 0x02000000 |   |               |                               |
|        | 26  | 0x04000000 |   |               |                               |
|        | 27  | 0x08000000 |   |               |                               |
| N7     | 28  | 0x10000000 | Reserved                                    |               |                               |
|        | 29  | 0x20000000 | Web content is corrupt or does not exist    | Content is OK | Error with content            |
|        | 30  | 0x40000000 | RF Calibration Data is present and in error | Data is OK    | Data has an error             |
|        | 31  | 0x80000000 | RF Calibration Data is present              | No data found | Data exists and has no errors |

**Table 160: Antenna Gain State**

| Bits 4-5<br>or<br>Bits 6-7 | Description   |
|----------------------------|---|
| 00                         | Antenna Gain in range   |
| 01                         | Antenna Gain Low<br>This state indicates that the input signal is very weak (under -160 dBm/Hz). It can indicate the antenna is not operating correctly, the antenna is not suitable for NovAtel receivers, or there is no antenna connected. |
| 10                         | Antenna Gain High.<br>This state indicates that the input signal is very strong (above -120 dBm/Hz). This can be caused by a strong in-band interference or by too much signal gain or too many LNAs cascaded in the path.                    |

<sup>1</sup>Some bits are only active when the corresponding modules are active. For example, the BT Pairing bit will not show 1 = device not paired unless the Bluetooth module is enabled.

| Bits 4-5<br>or<br>Bits 6-7 | Description  |
|----------------------------|--|
| 11                         | Antenna Gain Anomaly.<br>This state indicates that an anomaly has been detected for the input signal. It can be caused by strong in-band or out-of-band interference, or by the antenna being disconnected/changed during operation. |

**Table 161: Auxiliary 4 Status**

| Nibble | Bit | Mask       | Description | Bit = 0 | Bit = 1 |
|--------|-----|------------|-------------|---------|---------|
| N0     | 0   | 0x00000001 | Reserved    |         |         |
|        | 1   | 0x00000002 |             |         |         |
|        | 2   | 0x00000004 |             |         |         |
|        | 3   | 0x00000008 |             |         |         |
| N1     | 4   | 0x00000010 | Reserved    |         |         |
|        | 5   | 0x00000020 |             |         |         |
|        | 6   | 0x00000040 |             |         |         |
|        | 7   | 0x00000080 |             |         |         |
| N2     | 8   | 0x00000100 | Reserved    |         |         |
|        | 9   | 0x00000200 |             |         |         |
|        | 10  | 0x00000400 |             |         |         |
|        | 11  | 0x00000800 |             |         |         |
| N3     | 12  | 0x00001000 | Reserved    |         |         |
|        | 13  | 0x00002000 |             |         |         |
|        | 14  | 0x00004000 |             |         |         |
|        | 15  | 0x00008000 |             |         |         |

<sup>1</sup>Some bits are only active when the corresponding modules are active. For example, the BT Pairing bit will not show 1 = device not paired unless the Bluetooth module is enabled.

| Nibble | Bit | Mask       | Description | Bit = 0 | Bit = 1 |
|--------|-----|------------|-------------|---------|---------|
| N4     | 16  | 0x00010000 | Reserved    |         |         |
|        | 17  | 0x00020000 |             |         |         |
|        | 18  | 0x00040000 |             |         |         |
|        | 19  | 0x00080000 |             |         |         |
| N5     | 20  | 0x00100000 | Reserved    |         |         |
|        | 21  | 0x00200000 |             |         |         |
|        | 22  | 0x00400000 |             |         |         |
|        | 23  | 0x00800000 |             |         |         |
| N6     | 24  | 0x01000000 | Reserved    |         |         |
|        | 25  | 0x02000000 |             |         |         |
|        | 26  | 0x04000000 |             |         |         |
|        | 27  | 0x08000000 |             |         |         |
| N7     | 28  | 0x10000000 | Reserved    |         |         |
|        | 29  | 0x20000000 |             |         |         |
|        | 30  | 0x40000000 |             |         |         |
|        | 31  | 0x80000000 |             |         |         |

<sup>1</sup>Some bits are only active when the corresponding modules are active. For example, the BT Pairing bit will not show 1 = device not paired unless the Bluetooth module is enabled.

## 3.146 RXSTATUSEVENT

### *Status event indicator*

**Platform: OEM719, OEM729, OEM7500, OEM7700, OEM7720, PwrPak7, HxGN PIM7500**

This log is used to output event messages as indicated in the **RXSTATUS** log (see page 734). An event message is automatically generated for all receiver errors, which are indicated in the receiver error word. In addition, event messages can be generated when other conditions, which are indicated in the receiver status and auxiliary status words, are met. Whether or not an event message is generated under these conditions is specified using the **STATUSCONFIG** command (see page 354).

On start-up, the receiver is set to log the RXSTATUSEVENTA log ONNEW on all ports. You can remove this message by using the **UNLOG** command (see page 376).



See also the chapter on Built-In Status Tests in the [OEM7 Installation and Operation User Manual](#).

**Message ID: 94**

**Log Type: Asynch**

**Recommended Input:**

```
log rxstatuseventa onchanged
```

**ASCII Example 1:**

```
#RXSTATUSEVENTA, COM1, 0, 17.0, FREEWHEELING, 1337, 408334.510, 02480000, b967, 1984; STATUS, 19, SET, "No Valid Position Calculated"*6de945ad
```

**ASCII Example 2:**

```
#RXSTATUSEVENTA, COM1, 0, 41.0, FINESTEERING, 1337, 408832.031, 03000400, b967, 1984; STATUS, 10, SET, "COM3 Transmit Buffer Overrun"*5b5682a9
```



When a fatal event occurs (for example, in the event of a receiver hardware failure), a bit is set in the receiver error word, part of the **RXSTATUS** log (see page 734) to indicate the cause of the problem. Bit 0 is set in the receiver status word to show that an error occurred, the error strobe is driven high and the LED flashes red and yellow showing an error code. An RXSTATUSEVENT log is generated on all ports to show the cause of the error. Receiver tracking is disabled at this point but command and log processing continues to allow you to diagnose the error. Even if the source of the error is corrected at this point, the receiver must be reset to resume normal operation.

| Field | Field type           | Description  | Format    | Binary Bytes | Binary Offset |
|-------|----------------------|--|-----------|--------------|---------------|
| 1     | RXSTATUSEVENT header | Log header. See <i>Messages</i> on page 25 for more information.   |           | H            | 0             |
| 2     | word                 | The status word that generated the event message (see <i>Table 162: Status Word</i> below)   | Enum      | 4            | H             |
| 3     | bit position         | Location of the bit in the status word (see <i>Table 155: Receiver Status</i> on page 739, <i>Table 157: Auxiliary 1 Status</i> on page 741, <i>Table 158: Auxiliary 2 Status</i> on page 743 or <i>Table 159: Auxiliary 3 Status</i> on page 745) | Ulong     | 4            | H+4           |
| 4     | event                | Event type (see <i>Table 163: Event Type</i> below)  | Enum      | 4            | H+8           |
| 5     | description          | This is a text description of the event or error   | Char [32] | 32           | H+12          |
| 6     | xxxx                 | 32-bit CRC (ASCII and Binary only)   | Ulong     | 4            | H+44          |
| 7     | [CR][LF]             | Sentence terminator (ASCII only)   | -         | -            | -             |

**Table 162: Status Word**

| Binary | ASCII  | Description   |
|--------|--------|---|
| 0      | ERROR  | Receiver Error word, see <i>Table 154: Receiver Error</i> on page 737         |
| 1      | STATUS | Receiver Status word, see <i>Table 155: Receiver Status</i> on page 739       |
| 2      | AUX1   | Auxiliary 1 Status word, see <i>Table 157: Auxiliary 1 Status</i> on page 741 |
| 3      | AUX2   | Auxiliary 2 Status word see <i>Table 158: Auxiliary 2 Status</i> on page 743  |
| 4      | AUX3   | Auxiliary 3 Status word see <i>Table 159: Auxiliary 3 Status</i> on page 745  |

**Table 163: Event Type**

| Binary | ASCII | Description     |
|--------|-------|-----------------|
| 0      | CLEAR | Bit was cleared |
| 1      | SET   | Bit was set     |

## 3.147 SAFEMODESTATUS

### *Safe Mode Status*

**Platform: OEM719, OEM729, OEM7500, OEM7700, OEM7720, PwrPak7, HxGN PIM7500**

This log provides additional information about the state of the receiver in the event that the *Safe Mode* error bit and/or *Reset Loop Detected* status bit are set in the **RXSTATUS** log (see page 734).

The data within this log is set at receiver start up and will not change over time.

**Message ID: 2060**

**Log Type: Asynch**

**Recommended Input:**

```
log SAFEMODESTATUSA once
```

**Abbreviated ASCII Example:**

```
#SAFEMODESTATUSA, COM1, 0, 89.0, UNKNOWN, 0, 0.000, 024c0020, 8e55, 32768;SAFE_
MODE_OK, 0, "Normal Operation."*29c7d28a
```

| Field | Field Type            | Description  | Binary Format | Binary Bytes | Binary Offset |
|-------|-----------------------|--|---------------|--------------|---------------|
| 1     | SAFEMODESTATUS header | Log header. See <i>Messages</i> on page 25 for more information.         | -             | H            | 0             |
| 2     | Status                | Safe Mode State. See <i>Table 164: Safe Mode States</i> on the next page | Enum          | 4            | H             |
| 3     | Reset Count           | Number of resets since power up or a successful boot                     | Ulong         | 4            | H+4           |
| 4     | Description           | String for additional information about the Safe Mode State              | String        | 80           | H+8           |
| 5     | xxxx                  | 32-bit CRC (ASCII and Binary only)                                       | Ulong         | 4            | H+88          |
| 6     | [CR][LF]              | Sentence terminator (ASCII only)   | -             | -            | -             |

**Table 164: Safe Mode States**

| Value | State                                   | Safe Mode Error Bit | Reset Loop Detected Bit | Notes  | Recovery Steps   |
|-------|---|---------------------|-------------------------|--|--|
| 0     | SAFE_MODE_OK                            | 0                   | 0                       | Normal Operation. No reset loop detected.  | No action required   |
| 1     | SAFE_MODE_WARNING                       | 0                   | 1                       | An unexpected reset was detected. The receiver will operate as normal  | No action required   |
| 2     | SAFE_MODE_DISABLE_SATELLITE_DATA        | 0                   | 1                       | Satellite Navigation Data previously saved to NVM is ignored in this state. As the receiver continues to track GNSS satellites, new data will be downloaded. There may be some delay in initial satellite acquisition as this will effectively be a Cold Start, but the receiver will otherwise operate as normal. | No action required   |
| 3     | SAFE_MODE_DISABLE_NON_COMMUNICATION_NVM | 1                   | 1                       | All data previously saved to NVM that is not related to communication is ignored in this state.<br><br>Communication ports (COM, USB, ICOM, etc.) will remain in the configuration previously saved by SAVECONFIG allowing the user to take corrective action.   | Depending on what NVM data is causing the problem, a <b>FRESET</b> may resolve the issue.<br><br>If a standard <b>FRESET</b> does not resolve the issue, see the <b>FRESET</b> command on page 170 for other NVM targets that may be causing the issue and could be removed. |



| Value | State                              | Safe Mode Error Bit | Reset Loop Detected Bit | Notes  | Recovery Steps   |
|-------|------------------------------------|---------------------|-------------------------|--|--|
| 4     | SAFE_MODE_DISABLE_ALL_NVM          | 1                   | 1                       | All data previously saved to NVM is ignored in this state.                     | See recovery steps for SAFE_MODE_DISABLE_NON_COMMUNICATION_NVM.  |
| 5     | SAFE_MODE_DISABLE_AUTH             | 1                   | 1                       | All data previously saved to NVM and all Auth Codes are ignored in this state. | Use the <b>AUTH REMOVE</b> command to remove the offending Auth Code. The <b>AUTHCODES</b> log (see page 401) can be used to determine what Auth Codes are currently loaded. |
| 6     | SAFE_MODE_FAILED                   | 1                   | 1                       | All data previously saved to NVM and all Auth Codes are ignored in this state. | This state is unexpected. The recovery steps for other states may apply.   |
| 7     | SAFE_MODE_UNEXPECTED_MAIN_FIRMWARE | 1                   | 0 or 1                  | An error related to main firmware loading occurred.                            | Reload the main firmware.  |

## 3.148 SATVIS2

### *Satellite visibility*

**Platform: OEM719, OEM729, OEM7500, OEM7700, OEM7720, PwrPak7, HxGN PIM7500**

This log contains satellite visibility data for all available systems with additional satellite and satellite system information. One log is output for each available satellite system.



1. The SATVIS2 log is meant to provide a brief overview. The satellite positions and velocities used in the computation of this log are based on Almanac orbital parameters, not the higher precision Ephemeris parameters.
2. In the SATVIS2 log output, there may be double satellite number entries. These are GLONASS antipodal satellites in the same orbit plane separated by 180 degrees latitude. Refer to the GLONASS section of [An Introduction to GNSS](#) available on our website.
3. The SATVIS2 log is generated every 10 seconds. If the log is requested at a faster rate than ontime 10, it will only be output every 10 seconds.

**Message ID: 1043**

**Log Type: Asynch**

**Recommended Input:**

```
log satvis2a onchanged
```

**Abbreviated ASCII Example:**

```
<SATVIS2 COM1 5 70.0 FINESTEERING 1729 166550.000 02000000 a867 44263
< GPS TRUE TRUE 31
< 32 0 71.1 177.8 -1183.650 -1184.441
< 20 0 66.2 265.9 462.684 461.894
...
< 26 0 -78.7 246.3 805.272 804.481
< 9 0 -79.0 7.3 -930.480 -931.271
<SATVIS2 COM1 4 70.0 FINESTEERING 1729 166550.000 02000000 a867 44263
< GLONASS TRUE TRUE 24
< 3+5 0 75.2 326.1 1088.078 1087.272
< 13-2 0 61.4 188.2 2243.727 2242.923
...
< 9-2 0 -72.3 6.3 -1384.534 -1385.337
< 7+5 0 -81.2 146.3 -666.742 -667.548
<SATVIS2 COM1 0 70.0 FINESTEERING 1729 166550.000 02000000 a867 44263
< BEIDOU TRUE TRUE 14
< 11 0 2.6 342.2 -711.023 -711.807
< 12 0 -5.0 297.0 -2407.877 -2408.661
...
```

```

< 10 216 -79.3 254.5 122.316 121.532
< 13 216 -81.5 51.2 76.611 75.827

```

| Field | Field type       | Description  | Format | Binary Bytes | Binary Offset |
|-------|------------------|--|--------|--------------|---------------|
| 1     | SATVIS2 header   | Log header. See <i>Messages</i> on page 25 for more information.   |        | H            | 0             |
| 2     | Satellite System | GNSS satellite system identifier. See <i>Table 102: Satellite System</i> on page 532   | Enum   | 4            | H             |
| 3     | sat vis          | Is satellite visibility valid?<br>0 = FALSE<br>1 = TRUE  | Enum   | 4            | H+4           |
| 4     | comp alm         | Was complete GNSS almanac used?<br>0 = FALSE<br>1 = TRUE   | Enum   | 4            | H+8           |
| 5     | #sat             | Number of satellites with data to follow   | Ulong  | 4            | H+12          |
| 6     | Satellite ID     | In binary logs, the satellite ID field is 4 bytes. The 2 lowest order bytes, interpreted as a USHORT, are the system identifier: for instance, the PRN for GPS or the slot for GLONASS. The 2 highest-order bytes are the frequency channel for GLONASS, interpreted as a SHORT and zero for all other systems. In ASCII and abbreviated ASCII logs, the satellite ID field is the system identifier. If the system is GLONASS and the frequency channel is not zero, then the signed channel is appended to the system identifier. For example, slot 13, frequency channel -2 is output as 13-2<br>For more information, refer to <i>PRN Numbers</i> on page 46 | Ulong  | 4            | H+16          |
| 7     | health           | Satellite health<br> Satellite health values may be found in the applicable Interface Control Document for each system.   | Ulong  | 4            | H+20          |
| 8     | elev             | Elevation (degrees)  | Double | 8            | H+24          |
| 9     | az               | Azimuth (degrees)  | Double | 8            | H+32          |

| Field | Field type                                   | Description   | Format | Binary Bytes | Binary Offset     |
|-------|--|---|--------|--------------|-------------------|
| 10    | true dop                                     | Theoretical Doppler of satellite - the expected Doppler frequency based on a satellite's motion relative to the receiver. It is computed using the satellite's coordinates and velocity along with the receiver's coordinates and velocity (Hz) | Double | 8            | H+40              |
| 11    | app dop                                      | Apparent Doppler for this receiver - the same as Theoretical Doppler above but with clock drift correction added (Hz)   | Double | 8            | H+48              |
| 12    | Next satellite offset = H + 16 + (#sat x 40) |   |        |              |                   |
| 13    | xxxx   | 32-bit CRC (ASCII and Binary only)  | Ulong  | 4            | H+16+ (#sat x 40) |
| 14    | [CR][LF]                                     | Sentence terminator (ASCII only)  | -      | -            | -                 |

## 3.149 SATXYZ2

### *Satellite positions in ECEF Cartesian coordinates*

**Platform: OEM719, OEM729, OEM7500, OEM7700, OEM7720, PwrPak7, HxGN PIM7500**

When combined with a RANGE log, this data set contains the decoded satellite information necessary to compute the solution: satellite coordinates (ECEF WGS84), satellite clock correction, ionospheric corrections and tropospheric corrections. See the calculation examples in the usage box below. Only those satellites used in the corresponding PSRPOS solution are reported here. See also *Figure 11: The WGS84 ECEF Coordinate System* on page 437.

**Message ID: 1451**

**Log Type: Synch**

**Recommended Input:**

```
log satxyz2 ontime 1
```

**Abbreviated ASCII Example:**

```
<SATXYZ2 COM1 0 83.5 FINESTEERING 1686 489605.000 02000040 7513 43391
< 18
< GPS 1 -15502299.3828 1012325.6443 21538404.8435 76246.262 6.990
3.395 0.0 0.0
< GPS 19 -25806091.5135 -6923139.1454 1709844.1975 -78547.421 5.734
9.238 0.0 0.0
< GPS 12 20368857.0090 -5772890.2153 15912912.0724 20118.104 2.415
12.239 0.0 0.0
...
< GLONASS 23+3 -22246787.0962 -4287240.2873 11721201.0046 -
116210.453 6.928 4.205 0.0 0.0
< GLONASS 7+5 4586441.8834 -14896106.2729 20222034.1193 -6061.174
1.636 2.529 0.0 0.0
< GLONASS 8+6 -12121452.4145 -4467306.1322 21995556.9720 -7165.609
0.350 2.586 0.0 0.0
```



The OEM7 family use positive numbers for ionospheric and tropospheric corrections. A positive clock offset indicates the clock is running ahead of the reference time. Positive ionospheric and tropospheric corrections are added to the geometric ranges or subtracted from the measured pseudoranges. For example:

$$P = p + pd + c(dT - dt) + d(\text{ion}) + d(\text{trop}) + E_p$$

is equivalent to

$$P - c(dT - dt) - d(\text{ion}) - d(\text{trop}) = p + pd + E_p$$

where

$P$  = measured pseudorange

$p$  = geometric range

$pd$  = orbit error

$dt$  = satellite clock offset

$dT$  = receiver clock offset

$d(\text{ion})$  = ionospheric delay

$d(\text{trop})$  = tropospheric delay

$c$  = speed of light

$E_p$  = noise and multipath

| Field | Field Type                              | Description  | Format | Binary Bytes | Binary Offset |
|-------|---|--|--------|--------------|---------------|
| 1     | SATXYZ2 header                          | Log header. See <i>Messages</i> on page 25 for more information.           | -      | H            | 0             |
| 2     | #sat                                    | Number of satellites to follow   | Ulong  | 4            | H             |
| 3     | System                                  | Satellite system (refer to <i>Table 102: Satellite System</i> on page 532) | Enum   | 4            | H+4           |
| 4     | Satellite ID                            | Satellite ID   | Ulong  | 4            | H+8           |
| 5     | X                                       | Satellite X co-ordinates (ECEF,m)  | Double | 8            | H+12          |
| 6     | Y                                       | Satellite Y co-ordinates (ECEF,m)  | Double | 8            | H+20          |
| 7     | Z                                       | Satellite Z co-ordinates (ECEF,m)  | Double | 8            | H+28          |
| 8     | clk corr                                | Satellite clock correction (m)   | Double | 8            | H+36          |
| 9     | iono delay                              | Ionosphere delay (m)   | Double | 8            | H+44          |
| 10    | tropo delay                             | Troposphere delay (m)  | Double | 8            | H+52          |
| 11    | Reserved1                               |  | Double | 8            | H+60          |
| 12    | Reserved2                               |  | Double | 8            | H+68          |
| 13    | Next satellite offset = H+4+(#sat x 72) |  |        |              |               |

---

| Field | Field Type | Description                        | Format | Binary Bytes | Binary Offset          |
|-------|------------|------------------------------------|--------|--------------|------------------------|
| 14    | xxxx       | 32-bit CRC (ASCII and Binary only) | Ulong  | 4            | H+4+<br>(#sat x<br>72) |
| 15    | [CR][LF]   | Sentence terminator (ASCII only)   |        |              |                        |

## 3.150 SBAS0

***Do not use for safety applications***

**Platform: OEM719, OEM729, OEM7500, OEM7700, OEM7720, PwrPak7, HxGN PIM7500**

This message specifies the PRN if GEO transmitting SBAS corrections is operating in test mode, and should not be used for safety applications for a period of time outlined in the SBAS signal specification.



The GEO transmitting SBAS corrections is operating in test mode, and should not be used for safety-of-life applications.

See how the SBAS0 message relates to the SBAS testing modes in the **SBASCONTROL** command on page 314.

**Message ID: 976**

**Log Type: Asynch**

**Recommended Input:**

```
log SBAS0a onchanged
```

**ASCII Example:**

```
#SBAS0A, COM1, 0, 68.5, SATTIME, 1093, 161299.000, 02040020, 7d6a, 209; 122*e9a5ab08
```



Although the SBAS was designed for aviation users, it supports a wide variety of non-aviation uses including agriculture, surveying, recreation, and surface transportation.

| Field | Field type   | Description  | Format | Binary Bytes | Binary Offset |
|-------|--------------|--|--------|--------------|---------------|
| 1     | SBAS0 header | Log header. See <i>Messages</i> on page 25 for more information. |        | H            | 0             |
| 2     | prn          | Source PRN message - also PRN not to use                         | Ulong  | 4            | H             |
| 3     | xxxx         | 32-bit CRC (ASCII and Binary only)                               | Ulong  | 4            | H+4           |
| 4     | [CR][LF]     | Sentence terminator (ASCII only)                                 | -      | -            | -             |



## 3.151 SBAS1

### *PRN mask assignments*

**Platform: OEM719, OEM729, OEM7500, OEM7700, OEM7720, PwrPak7, HxGN PIM7500**

The PRN mask is given in SBAS1. The transition of the PRN mask to a new one (which will be infrequent) is controlled with the 2-bit IODP, which sequences to a number between 0 and 3. The same IODP appears in the applicable SBAS2, SBAS3, SBAS4, SBAS5, SBAS7, SBAS24 and SBAS25 messages (SBAS32, SBAS33, SBAS34, SBAS35 and SBAS45). This transition would probably only occur when a new satellite is launched or when a satellite fails and is taken out of service permanently. A degraded satellite may be flagged as a “don’t use” satellite temporarily.

**Message ID: 977**

**Log Type: Asynch**

**Recommended Input:**

```
log SBAS1a onchanged
```

**ASCII Example:**

```
#SBAS1A, COM1, 0, 24.5, SATTIME, 1337, 415802.000, 02000000, 5955, 1984;134, ffe  
ffffe0000000000000000000000000004004000000000000000000, 2*3633cf7b
```



Each raw SBAS frame gives data for a specific frame decoder number. The SBAS1 message can be logged to view the data breakdown of SBAS frame 1 which contains information about the PRN mask assignment.

| Field | Field type   | Description  | Format     | Binary Bytes    | Binary Offset |
|-------|--------------|--|------------|-----------------|---------------|
| 1     | SBAS1 header | Log header. See <i>Messages</i> on page 25 for more information. |            | H               | 0             |
| 2     | prn          | Source PRN of message  | Ulong      | 4               | H             |
| 3     | mask         | PRN bit mask   | Uchar [27] | 28 <sup>1</sup> | H+4           |
| 4     | iodp         | Issue of PRN mask data   | Ulong      | 4               | H+32          |
| 5     | xxxx         | 32-bit CRC (ASCII and Binary only)                               | Ulong      | 4               | H+36          |
| 6     | [CR][LF]     | Sentence terminator (ASCII only)                                 | -          | -               | -             |

<sup>1</sup>In the binary log case, an additional 1 byte of padding is added to maintain 4-byte alignment.

## 3.152 SBAS2

### *Fast correction slots 0-12*

**Platform: OEM719, OEM729, OEM7500, OEM7700, OEM7720, PwrPak7, HxGN PIM7500**

SBAS2 are fast corrections for slots 0-12 in the mask of SBAS1. This message may or may not come when SBAS is in testing mode (see the **SBASCONTROL** command on page 314 for details).

**Message ID: 982**

**Log Type: Asynch**

**Recommended Input:**

log SBAS2a onchanged

**ASCII Example:**

```
#SBAS2A, COM1, 0, 29.0, SATTIME, 1337, 415925.000, 02000000, e194, 1984; 134, 2, 2, 3, -3, 5, 1, 2047, -2, 2047, 2047, 2047, 2047, 2047, -3, 2, 5, 11, 7, 8, 14, 8, 14, 14, 14, 14, 14, 14, 6, 12*8d8d2e1c
```



Each raw SBAS frame gives data for a specific frame decoder number. The SBAS2 message can be logged to view the data breakdown of SBAS frame 2 which contains information about fast correction slots 0-12.

| Field | Field type   | Description  | Format | Binary Bytes | Binary Offset |
|-------|--------------|--|--------|--------------|---------------|
| 1     | SBAS2 header | Log header. See <i>Messages</i> on page 25 for more information. |        | H            | 0             |
| 2     | prn          | Source PRN of message  | Ulong  | 4            | H             |
| 3     | iodf         | Issue of fast corrections data                                   | Ulong  | 4            | H+4           |
| 4     | iodp         | Issue of PRN mask data   | Ulong  | 4            | H+8           |

| Field | Field type   | Description   | Format | Binary Bytes | Binary Offset |
|-------|--------------|---|--------|--------------|---------------|
| 5     | prc0         | prc(i):<br>Fast corrections<br>(-2048 to +2047) for the PRN in slot i (i = 0-12)  | Long   | 4            | H+12          |
| 6     | prc1         |   | Long   | 4            | H+16          |
| 7     | prc2         |   | Long   | 4            | H+20          |
| 8     | prc3         |   | Long   | 4            | H+24          |
| 9     | prc4         |   | Long   | 4            | H+28          |
| 10    | prc5         |   | Long   | 4            | H+32          |
| 11    | prc6         |   | Long   | 4            | H+36          |
| 12    | prc7         |   | Long   | 4            | H+40          |
| 13    | prc8         |   | Long   | 4            | H+44          |
| 14    | prc9         |   | Long   | 4            | H+48          |
| 15    | prc10        |   | Long   | 4            | H+52          |
| 16    | prc11        |   | Long   | 4            | H+56          |
| 17    | prc12        |   | Long   | 4            | H+60          |
| 18    | udre0        | udre(i):<br>User differential range error indicator for the PRN in slot i (i = 0-12)<br><i>See Table 165: Evaluation of UDREI on the next page for scaling information.</i> | Ulong  | 4            | H+64          |
| 19    | udre1        |   | Ulong  | 4            | H+68          |
| 20    | udre2        |   | Ulong  | 4            | H+72          |
| 21    | udre3        |   | Ulong  | 4            | H+76          |
| 22    | udre4        |   | Ulong  | 4            | H+80          |
| 23    | udre5        |   | Ulong  | 4            | H+84          |
| 24    | udre6        |   | Ulong  | 4            | H+88          |
| 25    | udre7        |   | Ulong  | 4            | H+92          |
| 26    | udre8        |   | Ulong  | 4            | H+96          |
| 27    | udre9        |   | Ulong  | 4            | H+100         |
| 28    | udre10       |   | Ulong  | 4            | H+104         |
| 29    | udre11       |   | Ulong  | 4            | H+108         |
| 30    | udre12       |   | Ulong  | 4            | H+112         |
| 31    | xxxx         | 32-bit CRC (ASCII and Binary only)  | Ulong  | 4            | H+116         |
| 32    | [CR]<br>[LF] | Sentence terminator (ASCII only)  | -      | -            | -             |

**Table 165: Evaluation of UDREI**

| <b>UDREI</b> | <b>UDRE metres</b> | <b><math>\sigma^2_{i.udre}</math> metres<sup>2</sup></b> |
|--------------|--------------------|--|
| 0            | 0.75               | 0.0520   |
| 1            | 1.0                | 0.0924   |
| 2            | 1.25               | 0.1444   |
| 3            | 1.75               | 0.2830   |
| 4            | 2.25               | 0.4678   |
| 5            | 3.0                | 0.8315   |
| 6            | 3.75               | 1.2992   |
| 7            | 4.5                | 1.8709   |
| 8            | 5.25               | 2.5465   |
| 9            | 6.0                | 3.3260   |
| 10           | 7.5                | 5.1968   |
| 11           | 15.0               | 20.7870  |
| 12           | 50.0               | 230.9661   |
| 13           | 150.0              | 2078.695   |
| 14           | Not Monitored      | Not Monitored  |
| 15           | Do Not Use         | Do Not Use   |

---

<sup>1</sup>The s2UDRE broadcast in SBAS2, SBAS3, SBAS4, SBAS5, SBAS6 and SBAS24 applies at a time prior to or at the time of applicability of the associated corrections.

## 3.153 SBAS3

### *Fast corrections slots 13-25*

**Platform: OEM719, OEM729, OEM7500, OEM7700, OEM7720, PwrPak7, HxGN PIM7500**

SBAS3 are fast corrections for slots 13-25 in the mask of SBAS1.

**Message ID: 987**

**Log Type: Asynch**

**Recommended Input:**

```
log SBAS3a onchanged
```

**ASCII Example:**

```
#SBAS3A,COM1,0,17.0,SATTIME,1337,415990.000,02000000,bff5,1984;134,1,2,2047,0,2047,2047,-21,-4,2047,2047,-1,0,2,2047,6,14,5,14,14,11,5,14,14,5,7,5,14,8*a25aebc5
```



Each raw SBAS frame gives data for a specific frame decoder number. The SBAS3 message can be logged to view the data breakdown of SBAS frame 3 which contains information about fast correction slots 13-25.

| Field | Field type   | Description  | Format | Binary Bytes | Binary Offset |
|-------|--------------|--|--------|--------------|---------------|
| 1     | SBAS3 header | Log header. See <i>Messages</i> on page 25 for more information. |        | H            | 0             |
| 2     | prn          | Source PRN of message  | Ulong  | 4            | H             |
| 3     | iodf         | Issue of fast corrections data                                   | Ulong  | 4            | H+4           |
| 4     | iodp         | Issue of PRN mask data   | Ulong  | 4            | H+8           |

| Field | Field type | Description   | Format | Binary Bytes | Binary Offset |
|-------|------------|---|--------|--------------|---------------|
| 5     | prc13      | prc(i):<br><br>Fast corrections (-2048 to +2047) for the PRN in slot i (i = 13-25)  | Long   | 4            | H+12          |
| 6     | prc14      |   | Long   | 4            | H+16          |
| 7     | prc15      |   | Long   | 4            | H+20          |
| 8     | prc16      |   | Long   | 4            | H+24          |
| 9     | prc17      |   | Long   | 4            | H+28          |
| 10    | prc18      |   | Long   | 4            | H+32          |
| 11    | prc19      |   | Long   | 4            | H+36          |
| 12    | prc20      |   | Long   | 4            | H+40          |
| 13    | prc21      |   | Long   | 4            | H+44          |
| 14    | prc22      |   | Long   | 4            | H+48          |
| 15    | prc23      |   | Long   | 4            | H+52          |
| 16    | prc24      |   | Long   | 4            | H+56          |
| 17    | prc25      |   | Long   | 4            | H+60          |
| 18    | udre13     | udre(i):<br><br>User differential range error indicator for the PRN in slot i (i = 13-25)<br><br><i>See Table 165: Evaluation of UDREI on page 764 for scaling information.</i> | Ulong  | 4            | H+64          |
| 19    | udre14     |   | Ulong  | 4            | H+68          |
| 20    | udre15     |   | Ulong  | 4            | H+72          |
| 21    | udre16     |   | Ulong  | 4            | H+76          |
| 22    | udre17     |   | Ulong  | 4            | H+80          |
| 23    | udre18     |   | Ulong  | 4            | H+84          |
| 24    | udre19     |   | Ulong  | 4            | H+88          |
| 25    | udre20     |   | Ulong  | 4            | H+92          |
| 26    | udre21     |   | Ulong  | 4            | H+96          |
| 27    | udre22     |   | Ulong  | 4            | H+100         |
| 28    | udre23     |   | Ulong  | 4            | H+104         |
| 29    | udre24     |   | Ulong  | 4            | H+108         |
| 30    | udre25     |   | Ulong  | 4            | H+112         |
| 31    | xxxx       | 32-bit CRC (ASCII and Binary only)  | Ulong  | 4            | H+116         |
| 32    | [CR][LF]   | Sentence terminator (ASCII only)  | -      | -            | -             |

## 3.154 SBAS4

### *Fast correction slots 26-38*

**Platform: OEM719, OEM729, OEM7500, OEM7700, OEM7720, PwrPak7, HxGN PIM7500**

SBAS4 are fast corrections for slots 26-38 in the mask of SBAS1.

**Message ID: 992**

**Log Type: Asynch**

**Recommended Input:**

```
log SBAS4a onchanged
```

**ASCII Example:**

```
#SBAS4A,COM1,0,58.0,SATTIME,1093,163399.000,02000020,b4b0,209;122,0,3,
2047,3,-1,2047,2047,2047,-3,-
1,5,3,3,2047,2,14,3,3,14,14,14,6,3,4,5,4,14,3*2e0894b1
```



Each raw SBAS frame gives data for a specific frame decoder number. The SBAS4 message can be logged to view the data breakdown of SBAS frame 4 which contains information about fast correction slots 26-38.

| Field | Field type   | Description  | Format | Binary Bytes | Binary Offset |
|-------|--------------|--|--------|--------------|---------------|
| 1     | SBAS4 header | Log header. See <i>Messages</i> on page 25 for more information. |        | H            | 0             |
| 2     | prn          | Source PRN of message  | Ulong  | 4            | H             |
| 3     | iodf         | Issue of fast corrections data                                   | Ulong  | 4            | H+4           |
| 4     | iodp         | Issue of PRN mask data   | Ulong  | 4            | H+8           |

| Field | Field type | Description   | Format | Binary Bytes | Binary Offset |
|-------|------------|---|--------|--------------|---------------|
| 5     | prc26      | prc(i):<br><br>Fast corrections (-2048 to +2047) for the PRN in slot i (i = 26-38)  | Long   | 4            | H+12          |
| 6     | prc27      |   | Long   | 4            | H+16          |
| 7     | prc28      |   | Long   | 4            | H+20          |
| 8     | prc29      |   | Long   | 4            | H+24          |
| 9     | prc30      |   | Long   | 4            | H+28          |
| 10    | prc31      |   | Long   | 4            | H+32          |
| 11    | prc32      |   | Long   | 4            | H+36          |
| 12    | prc33      |   | Long   | 4            | H+40          |
| 13    | prc34      |   | Long   | 4            | H+44          |
| 14    | prc35      |   | Long   | 4            | H+48          |
| 15    | prc36      |   | Long   | 4            | H+52          |
| 16    | prc37      |   | Long   | 4            | H+56          |
| 17    | prc38      |   | Long   | 4            | H+60          |
| 18    | udre26     | udre(i):<br><br>User differential range error indicator for the PRN in slot i (i = 26-38)<br><br><i>See Table 165: Evaluation of UDREI on page 764 for scaling information.</i> | Ulong  | 4            | H+64          |
| 19    | udre27     |   | Ulong  | 4            | H+68          |
| 20    | udre28     |   | Ulong  | 4            | H+72          |
| 21    | udre29     |   | Ulong  | 4            | H+76          |
| 22    | udre30     |   | Ulong  | 4            | H+80          |
| 23    | udre31     |   | Ulong  | 4            | H+84          |
| 24    | udre32     |   | Ulong  | 4            | H+88          |
| 25    | udre33     |   | Ulong  | 4            | H+92          |
| 26    | udre34     |   | Ulong  | 4            | H+96          |
| 27    | udre35     |   | Ulong  | 4            | H+100         |
| 28    | udre36     |   | Ulong  | 4            | H+104         |
| 29    | udre37     |   | Ulong  | 4            | H+108         |
| 30    | udre38     | Ulong   | 4      | H+112        |               |
| 31    | xxxx       | 32-bit CRC (ASCII and Binary only)  | Ulong  | 4            | H+116         |
| 32    | [CR][LF]   | Sentence terminator (ASCII only)  | -      | -            | -             |



## 3.155 SBAS5

### *Fast correction slots 39-50*

**Platform: OEM719, OEM729, OEM7500, OEM7700, OEM7720, PwrPak7, HxGN PIM7500**

SBAS5 are fast corrections for slots 39-50 in the mask of SBAS1.

**Message ID: 994**

**Log Type: Asynch**

**Recommended Input:**

```
log SBAS5a onchanged
```

**ASCII Example:**

```
#SBAS5A,COM1,0,72.5,SATTIME,1093,161480.000,02040020,31d4,209;122,1,3,-
7,2047,2047,2047,-4,2047,2047,2047,9,2047,2047,-3,-
2,11,14,14,14,4,14,14,14,5,14,14,4,2*2bf0109b
```



Each raw SBAS frame gives data for a specific frame decoder number. The SBAS5 message can be logged to view the data breakdown of SBAS frame 5 which contains information about fast correction slots 39-50.

| Field | Field type   | Description  | Format | Binary Bytes | Binary Offset |
|-------|--------------|--|--------|--------------|---------------|
| 1     | SBAS5 header | Log header. See <i>Messages</i> on page 25 for more information. |        | H            | 0             |
| 2     | prn          | Source PRN of message  | Ulong  | 4            | H             |
| 3     | iodf         | Issue of fast corrections data                                   | Ulong  | 4            | H+4           |
| 4     | iodp         | Issue of PRN mask data   | Ulong  | 4            | H+8           |

| Field | Field type                   | Description   | Format | Binary Bytes | Binary Offset |
|-------|------------------------------|---|--------|--------------|---------------|
| 5     | prc39                        | prc(i):<br><br>Fast corrections (-2048 to +2047) for the PRN in slot i (i = 39-50)  | Long   | 4            | H+12          |
| 6     | prc40                        |   | Long   | 4            | H+16          |
| 7     | prc41                        |   | Long   | 4            | H+20          |
| 8     | prc42                        |   | Long   | 4            | H+24          |
| 9     | prc43                        |   | Long   | 4            | H+28          |
| 10    | prc44                        |   | Long   | 4            | H+32          |
| 11    | prc45                        |   | Long   | 4            | H+36          |
| 12    | prc46                        |   | Long   | 4            | H+40          |
| 13    | prc47                        |   | Long   | 4            | H+44          |
| 14    | prc48                        |   | Long   | 4            | H+48          |
| 15    | prc49                        |   | Long   | 4            | H+52          |
| 16    | prc50                        |   | Long   | 4            | H+56          |
| 17    | prc51 (Invalid, do not use)  |   | Long   | 4            | H+60          |
| 18    | udre39                       | udre(i):<br><br>User differential range error indicator for the PRN in slot i (i = 39-50)<br><br><i>See Table 165: Evaluation of UDREI on page 764 for scaling information.</i> | Ulong  | 4            | H+64          |
| 19    | udre40                       |   | Ulong  | 4            | H+68          |
| 20    | udre41                       |   | Ulong  | 4            | H+72          |
| 21    | udre42                       |   | Ulong  | 4            | H+76          |
| 22    | udre43                       |   | Ulong  | 4            | H+80          |
| 23    | udre44                       |   | Ulong  | 4            | H+84          |
| 24    | udre45                       |   | Ulong  | 4            | H+88          |
| 25    | udre46                       |   | Ulong  | 4            | H+92          |
| 26    | udre47                       |   | Ulong  | 4            | H+96          |
| 27    | udre48                       |   | Ulong  | 4            | H+100         |
| 28    | udre49                       |   | Ulong  | 4            | H+104         |
| 29    | udre50                       |   | Ulong  | 4            | H+108         |
| 30    | udre51 (Invalid, do not use) |   | Ulong  | 4            | H+112         |
| 31    | xxxx                         | 32-bit CRC (ASCII and Binary only)  | Ulong  | 4            | H+116         |
| 32    | [CR][LF]                     | Sentence terminator (ASCII only)  | -      | -            | -             |

## 3.156 SBAS6

### *Integrity message*

**Platform: OEM719, OEM729, OEM7500, OEM7700, OEM7720, PwrPak7, HxGN PIM7500**

SBAS6 is the integrity information message. Each message includes an IODF for each fast corrections message. The  $\sigma^2_{UDRE}$  information for each block of satellites applies to the fast corrections with the corresponding IODF.

**Message ID: 995**

**Log Type: Asynch**

**Recommended Input:**

log SBAS6a onchanged

**ASCII Example:**

```
#SBAS6A, COM1, 0, 57.5, SATTIME, 1093, 273317.000, 02000020, 526a, 209; 122, 3, 3, 3, 3, 9, 14, 14, 2, 3, 10, 2, 14, 14, 3, 14, 14, 5, 14, 14, 7, 14, 14, 14, 14, 14, 14, 3, 3, 14, 14, 14, 14, 3, 15, 11, 11, 15, 0, 0, 0, 0, 0, 0, 0, 0, 0, 0, 0, 0, 0, 0, 0, 0, 0, 0, 0*925a2a9b
```



Each raw SBAS frame gives data for a specific frame decoder number. The SBAS6 message can be logged to view the data breakdown of SBAS frame 6 which contains information about the integrity message.

| Field | Field type   | Description  | Format | Binary Bytes | Binary Offset |
|-------|--------------|--|--------|--------------|---------------|
| 1     | SBAS6 header | Log header. See <i>Messages</i> on page 25 for more information.   |        | H            | 0             |
| 2     | prn          | Source PRN of message  | Ulong  | 4            | H             |
| 3     | iodf2        | Issue of fast corrections data   | Ulong  | 4            | H+4           |
| 4     | iodf3        | Issue of fast corrections data   | Ulong  | 4            | H+8           |
| 5     | iodf4        | Issue of fast corrections data   | Ulong  | 4            | H+12          |
| 6     | iodf5        | Issue of fast corrections data   | Ulong  | 4            | H+16          |
| 7     | udre0        | udre(i):<br>User differential range error indicator for the PRN in slot i (i = 0-50)<br><br>See <i>Table 165: Evaluation of UDREI</i> on page 764 for scaling information. | Ulong  | 4            | H+20          |

| Field | Field type | Description | Format | Binary Bytes | Binary Offset |
|-------|------------|-------------|--------|--------------|---------------|
| 8     | udre1      |             | Ulong  | 4            | H+24          |
| 9     | udre2      |             | Ulong  | 4            | H+28          |
| 10    | udre3      |             | Ulong  | 4            | H+32          |
| 11    | udre4      |             | Ulong  | 4            | H+36          |
| 12    | udre5      |             | Ulong  | 4            | H+40          |
| 13    | udre6      |             | Ulong  | 4            | H+44          |
| 14    | udre7      |             | Ulong  | 4            | H+48          |
| 15    | udre8      |             | Ulong  | 4            | H+52          |
| 16    | udre9      |             | Ulong  | 4            | H+56          |
| 17    | udre10     |             | Ulong  | 4            | H+60          |
| 18    | udre11     |             | Ulong  | 4            | H+64          |
| 19    | udre12     |             | Ulong  | 4            | H+68          |
| 20    | udre13     |             | Ulong  | 4            | H+72          |
| 21    | udre14     |             | Ulong  | 4            | H+76          |
| 22    | udre15     |             | Ulong  | 4            | H+80          |
| 23    | udre16     |             | Ulong  | 4            | H+84          |
| 24    | udre17     |             | Ulong  | 4            | H+88          |
| 25    | udre18     |             | Ulong  | 4            | H+92          |
| 26    | udre19     |             | Ulong  | 4            | H+96          |
| 27    | udre20     |             | Ulong  | 4            | H+100         |
| 28    | udre21     |             | Ulong  | 4            | H+104         |
| 29    | udre22     |             | Ulong  | 4            | H+108         |
| 30    | udre23     |             | Ulong  | 4            | H+112         |
| 31    | udre24     |             | Ulong  | 4            | H+116         |
| 32    | udre25     |             | Ulong  | 4            | H+120         |
| 33    | udre26     |             | Ulong  | 4            | H+124         |
| 34    | udre27     |             | Ulong  | 4            | H+128         |

| Field | Field type                   | Description                        | Format | Binary Bytes | Binary Offset |
|-------|------------------------------|------------------------------------|--------|--------------|---------------|
| 35    | udre28                       |                                    | Ulong  | 4            | H+132         |
| 36    | udre29                       |                                    | Ulong  | 4            | H+136         |
| 37    | udre30                       |                                    | Ulong  | 4            | H+140         |
| 38    | udre31                       |                                    | Ulong  | 4            | H+144         |
| 39    | udre32                       |                                    | Ulong  | 4            | H+148         |
| 40    | udre33                       |                                    | Ulong  | 4            | H+152         |
| 41    | udre34                       |                                    | Ulong  | 4            | H+156         |
| 42    | udre35                       |                                    | Ulong  | 4            | H+160         |
| 43    | udre36                       |                                    | Ulong  | 4            | H+164         |
| 44    | udre37                       |                                    | Ulong  | 4            | H+168         |
| 45    | udre38                       |                                    | Ulong  | 4            | H+172         |
| 46    | udre39                       |                                    | Ulong  | 4            | H+176         |
| 47    | udre40                       |                                    | Ulong  | 4            | H+180         |
| 48    | udre41                       |                                    | Ulong  | 4            | H+184         |
| 49    | udre42                       |                                    | Ulong  | 4            | H+188         |
| 50    | udre43                       |                                    | Ulong  | 4            | H+192         |
| 51    | udre44                       |                                    | Ulong  | 4            | H+196         |
| 52    | udre45                       |                                    | Ulong  | 4            | H+200         |
| 53    | udre46                       |                                    | Ulong  | 4            | H+204         |
| 54    | udre47                       |                                    | Ulong  | 4            | H+208         |
| 55    | udre48                       |                                    | Ulong  | 4            | H+212         |
| 56    | udre49                       |                                    | Ulong  | 4            | H+216         |
| 58    | udre50                       |                                    | Ulong  | 4            | H+220         |
| 58    | udre51 (Invalid, do not use) |                                    | Ulong  | 4            | H+224         |
| 59    | xxxx                         | 32-bit CRC (ASCII and Binary only) | Ulong  | 4            | H+228         |
| 60    | [CR][LF]                     | Sentence terminator (ASCII only)   | -      | -            | -             |

## 3.157 SBAS7

### *Fast correction degradation*

**Platform:** OEM719, OEM729, OEM7500, OEM7700, OEM7720, PwrPak7, HxGN PIM7500

The SBAS7 message specifies the applicable IODP, system latency time and fast degradation factor indicator for computing the degradation of fast and long term corrections.

**Message ID:** 996

**Log Type:** Asynch

**Recommended Input:**

```
log SBAS7a onchanged
```

**ASCII Example:**

```
#SBAS7A,COM1,0,36.5,SATTIME,1337,416367.000,02000000,12e3,1984;122,1,2
,0,15,15,15,15,15,15,15,15,15,15,15,15,15,15,15,15,15,15,15,15,15,1
5,15,15,15,15,15,15,15,15,0,0,0,0,0,0,0,0,0,0,0,0,0,0,0,0,0,0,0*827
a7364
```



Each raw SBAS frame gives data for a specific frame decoder number. The SBAS7 message can be logged to view the data breakdown of SBAS frame 7 which contains information about fast correction degradation.

| Field | Field type   | Description   | Format | Binary Bytes | Binary Offset |
|-------|--------------|---|--------|--------------|---------------|
| 1     | SBAS7 header | Log header. See <i>Messages</i> on page 25 for more information.        |        | H            | 0             |
| 2     | prn          | Source PRN of message   | Ulong  | 4            | H             |
| 3     | latency      | System latency (s)  | Ulong  | 4            | H+4           |
| 4     | iodp         | Issue of PRN mask data  | Ulong  | 4            | H+8           |
| 5     | spare bits   | Unused spare bits   | Ulong  | 4            | H+12          |
| 6     | aI(0)        | aI(i):<br>Degradation factor indicator for the PRN in slot i (i = 0-50) | Ulong  | 4            | H+16          |
| 7     | aI(1)        |   | Ulong  | 4            | H+20          |
| 8     | aI(2)        |   | Ulong  | 4            | H+24          |
| 9     | aI(3)        |   | Ulong  | 4            | H+28          |

| Field | Field type | Description | Format | Binary Bytes | Binary Offset |
|-------|------------|-------------|--------|--------------|---------------|
| 10    | aI(4)      |             | Ulong  | 4            | H+32          |
| 11    | aI(5)      |             | Ulong  | 4            | H+36          |
| 12    | aI(6)      |             | Ulong  | 4            | H+40          |
| 13    | aI(7)      |             | Ulong  | 4            | H+44          |
| 14    | aI(8)      |             | Ulong  | 4            | H+48          |
| 15    | aI(9)      |             | Ulong  | 4            | H+52          |
| 16    | aI(10)     |             | Ulong  | 4            | H+56          |
| 17    | aI(11)     |             | Ulong  | 4            | H+60          |
| 18    | aI(12)     |             | Ulong  | 4            | H+64          |
| 19    | aI(13)     |             | Ulong  | 4            | H+68          |
| 20    | aI(14)     |             | Ulong  | 4            | H+72          |
| 21    | aI(15)     |             | Ulong  | 4            | H+76          |
| 22    | aI(16)     |             | Ulong  | 4            | H+80          |
| 23    | aI(17)     |             | Ulong  | 4            | H+84          |
| 24    | aI(18)     |             | Ulong  | 4            | H+88          |
| 25    | aI(19)     |             | Ulong  | 4            | H+92          |
| 26    | aI(20)     |             | Ulong  | 4            | H+96          |
| 27    | aI(21)     |             | Ulong  | 4            | H+100         |
| 28    | aI(22)     |             | Ulong  | 4            | H+104         |
| 29    | aI(23)     |             | Ulong  | 4            | H+108         |
| 30    | aI(24)     |             | Ulong  | 4            | H+112         |
| 31    | aI(25)     |             | Ulong  | 4            | H+116         |
| 32    | aI(26)     |             | Ulong  | 4            | H+120         |
| 33    | aI(27)     |             | Ulong  | 4            | H+124         |
| 34    | aI(28)     |             | Ulong  | 4            | H+128         |
| 35    | aI(29)     |             | Ulong  | 4            | H+132         |
| 36    | aI(30)     |             | Ulong  | 4            | H+136         |

| Field | Field type                   | Description                        | Format | Binary Bytes | Binary Offset |
|-------|------------------------------|------------------------------------|--------|--------------|---------------|
| 37    | aI(31)                       |                                    | Ulong  | 4            | H+140         |
| 38    | aI(32)                       |                                    | Ulong  | 4            | H+144         |
| 39    | aI(33)                       |                                    | Ulong  | 4            | H+148         |
| 40    | aI(34)                       |                                    | Ulong  | 4            | H+152         |
| 41    | aI(35)                       |                                    | Ulong  | 4            | H+156         |
| 42    | aI(36)                       |                                    | Ulong  | 4            | H+160         |
| 43    | aI(37)                       |                                    | Ulong  | 4            | H+164         |
| 44    | aI(38)                       |                                    | Ulong  | 4            | H+168         |
| 45    | aI(39)                       |                                    | Ulong  | 4            | H+172         |
| 46    | aI(40)                       |                                    | Ulong  | 4            | H+176         |
| 47    | aI(41)                       |                                    | Ulong  | 4            | H+180         |
| 48    | aI(42)                       |                                    | Ulong  | 4            | H+184         |
| 49    | aI(43)                       |                                    | Ulong  | 4            | H+188         |
| 50    | aI(44)                       |                                    | Ulong  | 4            | H+192         |
| 51    | aI(45)                       |                                    | Ulong  | 4            | H+196         |
| 52    | aI(46)                       |                                    | Ulong  | 4            | H+200         |
| 53    | aI(47)                       |                                    | Ulong  | 4            | H+204         |
| 54    | aI(48)                       |                                    | Ulong  | 4            | H+208         |
| 55    | aI(49)                       |                                    | Ulong  | 4            | H+212         |
| 56    | aI(50)                       |                                    | Ulong  | 4            | H+216         |
| 57    | aI(51) (Invalid, do not use) |                                    | Ulong  | 4            | H+220         |
| 58    | xxxx                         | 32-bit CRC (ASCII and Binary only) | Ulong  | 4            | H+224         |
| 59    | [CR][LF]                     | Sentence terminator (ASCII only)   | -      | -            | -             |



## 3.158 SBAS9

### *GEO navigation message*

**Platform: OEM719, OEM729, OEM7500, OEM7700, OEM7720, PwrPak7, HxGN PIM7500**

SBAS9 provides the GEO navigation message representing the position, velocity and acceleration of the geostationary satellite, in ECEF coordinates and its apparent clock time and frequency offsets.

Also included is the time of applicability, an Issue of Data (IOD) and an accuracy exponent (URA) representing the estimated accuracy of the message. The time offset and time drift are with respect to SBAS Network Time. Their combined effect is added to the estimate of the satellite's transmit time.

**Message ID: 997**

**Log Type: Asynch**

**Recommended Input:**

log SBAS9a onchanged

**ASCII Example:**

```
#SBAS9A, COM1, 0, 38.0, SATTIME, 1337, 416426.000, 02000000, b580, 1984; 122, 175
, 70848, 2, 24802064.1600, -34087313.9200, -
33823.2000, 1.591250000, 0.107500000, 0.6080000, -0.0000750, -
0.0001125, 0.000187500, -2.235174179e-08, 9.094947018e-12*636051d2
```



Each raw SBAS frame gives data for a specific frame decoder number. The SBAS9 message can be logged to view the data breakdown of SBAS frame 9 which contains the GEO navigation message.

| Field | Field type   | Description  | Format | Binary Bytes | Binary Offset |
|-------|--------------|--|--------|--------------|---------------|
| 1     | SBAS9 header | Log header. See <i>Messages</i> on page 25 for more information. |        | H            | 0             |
| 2     | prn          | Source PRN of message  | Ulong  | 4            | H             |
| 3     | iodn         | Issue of GEO navigation data                                     | Ulong  | 4            | H+4           |
| 4     | $t_0$        | Time of applicability  | Ulong  | 4            | H+8           |
| 5     | ura          | URA value  | Ulong  | 4            | H+12          |
| 6     | x            | ECEF x coordinate (m)  | Double | 8            | H+16          |
| 7     | y            | ECEF y coordinate (m)  | Double | 8            | H+24          |

| Field | Field type      | Description                               | Format | Binary Bytes | Binary Offset |
|-------|-----------------|---|--------|--------------|---------------|
| 8     | z               | ECEF z coordinate (m)                     | Double | 8            | H+32          |
| 9     | xvel            | X rate of change (m/s)                    | Double | 8            | H+40          |
| 10    | yvel            | Y rate of change (m/s)                    | Double | 8            | H+48          |
| 11    | zvel            | Z rate of change (m/s)                    | Double | 8            | H+56          |
| 12    | xaccel          | X rate of rate change (m/s <sup>2</sup> ) | Double | 8            | H+64          |
| 13    | yaccel          | Y rate of rate change (m/s <sup>2</sup> ) | Double | 8            | H+72          |
| 14    | zaccel          | Z rate of rate change (m/s <sup>2</sup> ) | Double | 8            | H+80          |
| 15    | a <sub>f0</sub> | Time offset (s)                           | Double | 8            | H+88          |
| 16    | a <sub>f1</sub> | Time drift (s)                            | Double | 8            | H+96          |
| 17    | xxxx            | 32-bit CRC (ASCII and Binary only)        | Ulong  | 4            | H+104         |
| 18    | [CR][LF]        | Sentence terminator (ASCII only)          | -      | -            | -             |

## 3.159 SBAS10

### *Degradation factor*

**Platform: OEM719, OEM729, OEM7500, OEM7700, OEM7720, PwrPak7, HxGN PIM7500**

The fast corrections, long term corrections and ionospheric corrections are all provided in the SBAS10 message.

**Message ID: 978**

**Log Type: Asynch**

**Recommended Input:**

log SBAS10a onchanged

**ASCII Example:**

```
#SBAS10A,COM1,0,35.5,SATTIME,1337,416469.000,02000000,c305,1984;122,54
,38,76,256,152,100,311,83,256,6,0,300,292,0,1,0000000000000000000000*8
884d248
```



Each raw SBAS frame gives data for a specific frame decoder number. The SBAS10 message can be logged to view the data breakdown of SBAS frame 10 which contains information about degradation factors.

| Field | Field type          | Description   | Format | Binary Bytes | Binary Offset | Scaling |
|-------|---------------------|---|--------|--------------|---------------|---------|
| 1     | SBAS10 header       | Log header. See <i>Messages</i> on page 25 for more information.              |        | H            | 0             | -       |
| 2     | prn                 | Source PRN of message   | Ulong  | 4            | H             | -       |
| 3     | b <sub>rcc</sub>    | Estimated noise and round off error parameter                                 | Ulong  | 4            | H+4           | 0.002   |
| 4     | c <sub>lrc_ls</sub> | Maximum round off due to the least significant bit (lsb) of the orbital clock | Ulong  | 4            | H+8           | 0.002   |
| 5     | c <sub>lrc_vl</sub> | Velocity error bound  | Ulong  | 4            | H+12          | 0.00005 |
| 6     | i <sub>lrc_vl</sub> | Update interval for v=1 long term   | Ulong  | 4            | H+16          | -       |
| 7     | c <sub>lrc_v0</sub> | Bound on update delta   | Ulong  | 4            | H+20          | 0.002   |
| 8     | i <sub>lrc_v1</sub> | Minimum update interval v = 0   | Ulong  | 4            | H+24          | -       |
| 9     | c <sub>geo_ls</sub> | Maximum round off due to the lsb of the orbital clock                         | Ulong  | 4            | H+28          | 0.0005  |

| Field | Field type             | Description                                | Format  | Binary Bytes | Binary Offset | Scaling  |
|-------|------------------------|--|---------|--------------|---------------|----------|
| 10    | C <sub>geo_v</sub>     | Velocity error bound                       | Ulong   | 4            | H+32          | 0.00005  |
| 11    | i <sub>geo</sub>       | Update interval for GEO navigation message | Ulong   | 4            | H+36          | -        |
| 12    | C <sub>er</sub>        | Degradation parameter                      | Ulong   | 4            | H+40          | 0.5      |
| 13    | C <sub>iono_step</sub> | Bound on ionospheric grid delay difference | Ulong   | 4            | H+44          | 0.001    |
| 14    | i <sub>iono</sub>      | Minimum ionospheric update interval        | Ulong   | 4            | H+48          | -        |
| 15    | C <sub>iono_ramp</sub> | Rate of ionospheric corrections change     | Ulong   | 4            | H+52          | 0.000005 |
| 16    | rss <sub>udre</sub>    | User differential range error flag         | Ulong   | 4            | H+56          | -        |
| 17    | rss <sub>iono</sub>    | Root sum square flag                       | Ulong   | 4            | H+60          | -        |
| 18    | spare bits             | Spare 88 bits, possibly GLONASS            | Hex[11] | 11           | H+64          | -        |
| 19    | xxxx                   | 32-bit CRC (ASCII and Binary only)         | Ulong   | 4            | H+75          | -        |
| 20    | [CR]<br>[LF]           | Sentence terminator (ASCII only)           | -       | -            | -             | -        |

## 3.160 SBAS12

### *SBAS network time and UTC*

**Platform: OEM719, OEM729, OEM7500, OEM7700, OEM7720, PwrPak7, HxGN PIM7500**

SBAS12 contains information bits for the UTC parameters and UTC time standard from which an offset is determined. The UTC parameters correlate UTC time with the SBAS network time rather than with GPS reference time.

**Message ID: 979**

**Log Type: Asynch**

**Recommended Input:**

```
log SBAS12a onchanged
```



Each raw SBAS frame gives data for a specific frame decoder number. The SBAS12 message can be logged to view the data breakdown of SBAS frame 12 which contains information about time parameters.

| Field | Field type        | Description   | Format | Binary Bytes | Binary Offset |
|-------|-------------------|---|--------|--------------|---------------|
| 1     | SBAS12 header     | Log header. See <i>Messages</i> on page 25 for more information.        |        | H            | 0             |
| 2     | prn               | Source PRN of message   | Ulong  | 4            | H             |
| 3     | A <sub>1</sub>    | Time drift (s/s)  | Double | 8            | H+4           |
| 4     | A <sub>0</sub>    | Time offset (s)   | Double | 8            | H+12          |
| 5     | seconds           | Seconds into the week (s)   | Ulong  | 4            | H+20          |
| 6     | week              | Week number   | Ushort | 2            | H+24          |
| 7     | dt <sub>ls</sub>  | Delta time due to leap seconds  | Short  | 2            | H+26          |
| 8     | wn <sub>lsf</sub> | Week number, leap second future   | Ushort | 2            | H+28          |
| 9     | dn                | Day of the week (the range is 1 to 7 where Sunday = 1 and Saturday = 7) | Ushort | 2            | H+30          |
| 10    | dt <sub>lsf</sub> | Delta time, leap second future  | Ushort | 2            | H+32          |
| 11    | utc id            | UTC type identifier   | Ushort | 2            | H+34          |
| 12    | gpstow            | GPS reference time of the week  | Ulong  | 4            | H+36          |

| Field | Field type                              | Description  | Format    | Binary Bytes    | Binary Offset |
|-------|---|--|-----------|-----------------|---------------|
| 13    | gpswn                                   | GPS de-modulo week number                                | Ulong     | 4               | H+40          |
| 14    | glo indicator                           | Is GLONASS information present?<br>0 = FALSE<br>1 = TRUE | Enum      | 4               | H+44          |
| 15    | Reserved array of hexabytes for GLONASS |  | Char [10] | 12 <sup>1</sup> | H+48          |
| 16    | xxxx                                    | 32-bit CRC (ASCII and Binary only)                       | Ulong     | 4               | H+60          |
| 17    | [CR][LF]                                | Sentence terminator (ASCII only)                         | -         | -               | -             |

<sup>1</sup>In the binary log case, an additional 2 bytes of padding are added to maintain 4-byte alignment.

## 3.161 SBAS17

### *GEO Almanac message*

**Platform: OEM719, OEM729, OEM7500, OEM7700, OEM7720, PwrPak7, HxGN PIM7500**

Almanacs for all GEOs are broadcast periodically to alert you of their existence, location, the general service provided, status and health.



Unused almanacs have a PRN number of 0 and should be ignored, see *ASCII Example* below.

**Message ID: 980**

**Log Type: Asynch**

**Recommended Input:**

```
log SBAS17a onchanged
```

**ASCII Example:**

```
#SBAS17A,COM1,0,84.5,SATTIME,1610,514149.000,02000000,896c,39061;135,3,0,135,0,-11536200,-40536600,-260000,0,0,0,0,138,0,-12521600,-40258400,0,0,0,0,0,133,0,-5551000,-41774200,-1248000,0,0,120,82112*2be5146f
```



Each raw SBAS frame gives data for a specific frame decoder number. The SBAS17 message can be logged to view the data breakdown of SBAS frame 17 which contains GEO almanacs.

| Field | Field type    | Description  | Format | Binary Bytes   | Binary Offset |
|-------|---------------|--|--------|----------------|---------------|
| 1     | SBAS17 header | Log header. See <i>Messages</i> on page 25 for more information. |        | H              | 0             |
| 2     | prn           | Source PRN of message  | Ulong  | 4              | H             |
| 3     | #ents         | Number of almanac entries with information to follow             | Ulong  | 4              | H+4           |
| 4     | data id       | Data ID type   | Ushort | 2              | H+8           |
| 5     | entry prn     | PRN for this entry   | Ushort | 2              | H+10          |
| 6     | health        | Health bits  | Ushort | 4 <sup>1</sup> | H+12          |

<sup>1</sup>In the binary log case, an additional 2 bytes of padding is added to maintain 4-byte alignment.

| Field | Field type                    | Description   | Format | Binary Bytes | Binary Offset         |
|-------|-------------------------------|---|--------|--------------|-----------------------|
| 7     | x                             | ECEF x coordinate (m)                               | Long   | 4            | H+16                  |
| 8     | y                             | ECEF y coordinate (m)                               | Long   | 4            | H+20                  |
| 9     | z                             | ECEF z coordinate (m)                               | Long   | 4            | H+24                  |
| 10    | x vel                         | X rate of change (m/s)                              | Long   | 4            | H+28                  |
| 11    | y vel                         | Y rate of change (m/s)                              | Long   | 4            | H+32                  |
| 12    | z vel                         | Z rate of change (m/s)                              | Long   | 4            | H+36                  |
| 13... | Next entry = H+8+(#ents x 32) |   |        |              |                       |
| 14    | t0                            | Time of day in seconds (0 to 86336)<br>Scaling = 64 | Ulong  | 4            | H+8+<br>(#ents x 32)  |
| 15    | xxxx                          | 32-bit CRC (ASCII and Binary only)                  | Ulong  | 4            | H+12+<br>(#ents x 32) |
| 16    | [CR][LF]                      | Sentence terminator (ASCII only)                    | -      | -            | -                     |



## 3.162 SBAS18

### *IGP mask*

**Platform: OEM719, OEM729, OEM7500, OEM7700, OEM7720, PwrPak7, HxGN PIM7500**

The ionospheric delay corrections are broadcast as vertical delay estimates, at specified ionospheric grid points (IGPs), applicable to a signal on L1. The predefined IGPs are contained in 11 bands (numbered 0 to 10). Bands 0-8 are vertical bands on a Mercator projection map and bands 9-10 are horizontal bands on a Mercator projection map. Since it is impossible to broadcast IGP delays for all possible locations, a mask is broadcast to define the IGP locations providing the most efficient model of the ionosphere at the time.

**Message ID: 981**

**Log Type: Asynch**

**Recommended Input:**

```
log SBAS18a onchanged
```

**ASCII Example:**

```
#SBAS18A,COM1,0,33.0,SATTIME,1337,417074.000,02000000,f2c0,1984;122,4,2,2,0000ffc0007fc0003ff0000ff80007fe0007fe0003ff0000ff80,0*b1ed353e
```



Each raw SBAS frame gives data for a specific frame decoder number. The SBAS18 message can be logged to view the data breakdown of SBAS frame 18 which contains information about ionospheric grid points.

| Field | Field type    | Description  | Format     | Binary Bytes    | Binary Offset |
|-------|---------------|--|------------|-----------------|---------------|
| 1     | SBAS18 header | Log header. See <i>Messages</i> on page 25 for more information.                   |            | H               | 0             |
| 2     | prn           | Source PRN of message  | Ulong      | 4               | H             |
| 3     | #bands        | Number of bands broadcast  | Ulong      | 4               | H+4           |
| 4     | band num      | Specific band number that identifies which of the 11 IGP bands the data belongs to | Ulong      | 4               | H+8           |
| 5     | iodi          | Issue of ionospheric data  | Ulong      | 4               | H+12          |
| 6     | igp mask      | IGP mask   | Uchar [26] | 28 <sup>a</sup> | H+16          |

<sup>a</sup>In the binary log case, an additional 2 bytes of padding are added to maintain 4-byte alignment.

---

| <b>Field</b> | <b>Field type</b> | <b>Description</b>                 | <b>Format</b> | <b>Binary Bytes</b> | <b>Binary Offset</b> |
|--------------|-------------------|------------------------------------|---------------|---------------------|----------------------|
| 7            | spare bit         | One spare bit                      | Ulong         | 4                   | H+44                 |
| 8            | xxxx              | 32-bit CRC (ASCII and Binary only) | Ulong         | 4                   | H+48                 |
| 9            | [CR][LF]          | Sentence terminator (ASCII only)   | -             | -                   | -                    |

## 3.163 SBAS24

### *Mixed fast/slow corrections*

**Platform: OEM719, OEM729, OEM7500, OEM7700, OEM7720, PwrPak7, HxGN PIM7500**

If there are 6 or fewer satellites in a block, they may be placed in this mixed correction message. There is a fast data set for each satellite and a UDRE indicator. Each message also contains an IODP indicating the associated PRN mask.

The fast correction (PRC) has a valid range of -2048 to +2047. If the range is exceeded, a don't use indication is inserted into the user differential range error indicator (UDREI) field, see *Table 165: Evaluation of UDREI* on page 764. You should ignore extra data sets not represented in the PRN mask.

The time of applicability (T0) of the PRC is the start of the epoch of the WNT second that is coincident with the transmission at the GEO satellite of the first bit of the message block.

**Message ID: 983**

**Log Type: Asynch**

**Recommended Input:**

```
log SBAS24a onchanged
```

**ASCII Example:**

```
#SBAS24A,COM1,0,34.0,SATTIME,1337,417108.000,02000000,0a33,1984;134,2047,2047,2047,-1,-2,14,14,14,14,11,14,2,2,0,0,1,0,0,0,0,0,0,0,0,0,0,0,0,0,0*76ff954b
```



Each raw SBAS frame gives data for a specific frame decoder number. The SBAS24 message can be logged to view the data breakdown of SBAS frame 24 which contains mixed fast/slow corrections.

| Field | Field type    | Description  | Format | Binary Bytes | Binary Offset | Scaling |
|-------|---------------|--|--------|--------------|---------------|---------|
| 1     | SBAS24 header | Log header. See <i>Messages</i> on page 25 for more information. |        | H            | 0             | -       |
| 2     | prn           | Source PRN of message  | Ulong  | 4            | H             | -       |

| Field | Field type       | Description  | Format | Binary Bytes | Binary Offset | Scaling  |
|-------|------------------|--|--------|--------------|---------------|--|
| 3     | prc0             | prc(i):<br>Fast corrections (-2048 to +2047) for the PRN in slot i<br>(i = 0-5)        | Long   | 4            | H+4           | -  |
| 4     | prc1             |  | Long   | 4            | H+8           | -  |
| 5     | prc2             |  | Long   | 4            | H+12          | -  |
| 6     | prc3             |  | Long   | 4            | H+16          | -  |
| 7     | prc4             |  | Long   | 4            | H+20          | -  |
| 8     | prc5             |  | Long   | 4            | H+24          | -  |
| 9     | udre0            | udre(i):<br>User differential range error indicator for the PRN in slot i<br>(i = 0-5) | Ulong  | 4            | H+28          | See Table 165:<br>Evaluation of UDREI<br>on page 764 |
| 10    | udre1            |  | Ulong  | 4            | H+32          |  |
| 11    | udre2            |  | Ulong  | 4            | H+36          |  |
| 12    | udre3            |  | Ulong  | 4            | H+40          |  |
| 13    | udre4            |  | Ulong  | 4            | H+44          |  |
| 14    | udre5            |  | Ulong  | 4            | H+48          |  |
| 15    | iodp             | Issue of PRN mask data   | Ulong  | 4            | H+52          | -  |
| 16    | block id         | Associated message type  | Ulong  | 4            | H+56          |  |
| 17    | iodf             | Issue of fast corrections data   | Ulong  | 4            | H+60          | -  |
| 18    | spare            | Spare value  | Ulong  | 4            | H+64          | -  |
| 19    | vel              | Velocity code flag   | Ulong  | 4            | H+68          | -  |
| 20    | mask1            | Index into PRN mask (Type 1)   | Ulong  | 4            | H+72          | -  |
| 21    | iode1            | Issue of ephemeris data  | Ulong  | 4            | H+76          | -  |
| 22    | dx1              | Delta x (ECEF)   | Long   | 4            | H+80          | 0.125  |
| 23    | dy1              | Delta y (ECEF)   | Long   | 4            | H+84          | 0.125  |
| 24    | dz1              | Delta z (ECEF)   | Long   | 4            | H+88          | 0.125  |
| 25    | da <sup>f0</sup> | Delta a <sup>f0</sup> clock offset   | Long   | 4            | H+92          | 2 <sup>-31</sup>                                     |
| 26    | mask2            | Second index into PRN mask (Type 1)  | Ulong  | 4            | H+96          | -  |
| 27    | iode2            | Second issue of ephemeris data   | Ulong  | 4            | H+100         | -  |

| Field | Field type       | Description                                  | Format | Binary Bytes | Binary Offset | Scaling   |
|-------|------------------|--|--------|--------------|---------------|-----------|
| 28    | ddx              | Delta delta x (ECEF)                         | Long   | 4            | H+104         | $2^{-11}$ |
| 29    | ddy              | Delta delta y (ECEF)                         | Long   | 4            | H+108         | $2^{-11}$ |
| 30    | ddz              | Delta delta z (ECEF)                         | Long   | 4            | H+112         | $2^{-11}$ |
| 31    | da <sup>f1</sup> | Delta a <sup>f1</sup> clock offset           | Long   | 4            | H+116         | $2^{-39}$ |
| 32    | t <sub>0</sub>   | Applicable time of day                       | Ulong  | 4            | H+120         | 16        |
| 33    | iodp             | Issue of PRN mask data                       | Ulong  | 4            | H+124         | -         |
| 34    | corr spare       | Spare value when velocity code is equal to 0 | Ulong  | 4            | H+128         | -         |
| 35    | xxxx             | 32-bit CRC (ASCII and Binary only)           | Ulong  | 4            | H+132         | -         |
| 36    | [CR]<br>[LF]     | Sentence terminator (ASCII only)             | -      | -            | -             | -         |

## 3.164 SBAS25

### *Long term slow satellite corrections*

**Platform: OEM719, OEM729, OEM7500, OEM7700, OEM7720, PwrPak7, HxGN PIM7500**

SBAS25 provides error estimates for slow varying satellite ephemeris and clock errors with respect to WGS-84 ECEF coordinates.

**Message ID: 984**

**Log Type: Asynch**

**Recommended Input:**

log SBAS25a onchanged

**ASCII Example:**

```
#SBAS25A,COM1,0,37.5,SATTIME,1337,417193.000,02000000,b8ff,1984;134,1,
19,25,-1,-3,0,-15,0,0,0,1,-1,-
2,4465,2,0,1,0,0,0,0,0,0,0,0,0,0,0,0,0*81685317
```



Each raw SBAS frame gives data for a specific frame decoder number. The SBAS25 message can be logged to view the data breakdown of SBAS frame 25 which contains long term slow satellite corrections.

| Field | Field type     | Description  | Format | Binary Bytes | Binary Offset | Scaling |
|-------|----------------|--|--------|--------------|---------------|---------|
| 1     | SBAS25 header  | Log header. See <i>Messages</i> on page 25 for more information. |        | H            | 0             | -       |
| 2     | prn            | Source PRN of message  | Ulong  | 4            | H             | -       |
| 3     | 1st half vel   | Velocity code flag (0 or 1)                                      | Ulong  | 4            | H+4           | -       |
| 4     | 1st half mask1 | Index into PRN mask (Type 1)                                     | Ulong  | 4            | H+8           | -       |
| 5     | 1st half iode1 | Issue of ephemeris data  | Ulong  | 4            | H+12          | -       |
| 6     | 1st half dx1   | Delta x (ECEF)   | Long   | 4            | H+16          | 0.125   |
| 7     | 1st half dy1   | Delta y (ECEF)   | Long   | 4            | H+20          | 0.125   |

| Field | Field type               | Description  | Format | Binary Bytes | Binary Offset | Scaling          |
|-------|--------------------------|--|--------|--------------|---------------|------------------|
| 8     | 1st half dz1             | Delta z (ECEF)   | Long   | 4            | H+24          | 0.125            |
| 9     | 1st half a <sub>f0</sub> | Delta a <sub>f0</sub> clock offset   | Long   | 4            | H+28          | 2 <sup>-31</sup> |
| 10    | 1st half mask2           | Second index into PRN mask (Type 1)<br>Dummy value when velocity code = 1  | Ulong  | 4            | H+32          | -                |
| 11    | 1st half iode2           | Second issue of ephemeris data<br>Dummy value when velocity code = 1   | Ulong  | 4            | H+36          | -                |
| 12    | 1st half ddx             | Delta delta x (ECEF) when velocity code = 1<br>Delta x (dx) when velocity code = 0                                     | Long   | 4            | H+40          | 2 <sup>-11</sup> |
| 13    | 1st half ddy             | Delta delta y (ECEF) when velocity code = 1<br>Delta y (dy) when velocity code = 0                                     | Long   | 4            | H+44          | 2 <sup>-11</sup> |
| 14    | 1st half ddz             | Delta delta z (ECEF) when velocity code = 1<br>Delta z (dz) when velocity code = 0                                     | Long   | 4            | H+48          | 2 <sup>-11</sup> |
| 15    | 1st half a <sub>f1</sub> | Delta a <sub>f1</sub> clock offset when velocity code = 1<br>Delta a <sub>f0</sub> clock offset when velocity code = 0 | Long   | 4            | H+52          | 2 <sup>-39</sup> |
| 16    | 1st half t <sub>0</sub>  | Applicable time of day<br>Dummy value when velocity code = 0   | Ulong  | 4            | H+56          | 16               |
| 17    | 1st half iodp            | Issue of PRN mask data   | Ulong  | 4            | H+60          | -                |
| 18    | 1st half corr spare      | Spare value when velocity code = 0<br>Dummy value when velocity code = 1   | Ulong  | 4            | H+64          | -                |
| 19    | 2nd half vel             | Velocity code flag (0 or 1)  | Ulong  | 4            | H+68          | -                |
| 20    | 2nd half mask1           | Index into PRN mask (Type 1)   | Ulong  | 4            | H+72          | -                |

| Field | Field type               | Description  | Format | Binary Bytes | Binary Offset | Scaling          |
|-------|--------------------------|--|--------|--------------|---------------|------------------|
| 21    | 2nd half iode1           | Issue of ephemeris data  | Ulong  | 4            | H+76          | -                |
| 22    | 2nd half dx1             | Delta x (ECEF)   | Long   | 4            | H+80          | 0.125            |
| 23    | 2nd half dy1             | Delta y (ECEF)   | Long   | 4            | H+84          | 0.125            |
| 24    | 2nd half dz1             | Delta z (ECEF)   | Long   | 4            | H+88          | 0.125            |
| 25    | 2nd half a <sub>f0</sub> | Delta a <sub>f0</sub> clock offset   | Long   | 4            | H+92          | 2 <sup>-31</sup> |
| 26    | 2nd half mask2           | Second index into PRN mask (Type 1)<br>Dummy value when velocity code = 1  | Ulong  | 4            | H+96          | -                |
| 27    | 2nd half iode2           | Second issue of ephemeris data<br>Dummy value when velocity code = 1   | Ulong  | 4            | H+100         | -                |
| 28    | 2nd half ddx             | Delta delta x (ECEF) when velocity code = 1<br>Delta x (dx) when velocity code = 0                                     | Long   | 4            | H+104         | 2 <sup>-11</sup> |
| 29    | 2nd half ddy             | Delta delta y (ECEF) when velocity code = 1<br>Delta y (dy) when velocity code = 0                                     | Long   | 4            | H+108         | 2 <sup>-11</sup> |
| 30    | 2nd half ddz             | Delta delta z (ECEF) when velocity code = 1<br>Delta z (dz) when velocity code = 0                                     | Long   | 4            | H+112         | 2 <sup>-11</sup> |
| 31    | 2nd half a <sub>f1</sub> | Delta a <sub>f1</sub> clock offset when velocity code = 1<br>Delta a <sub>f0</sub> clock offset when velocity code = 0 | Long   | 4            | H+116         | 2 <sup>-39</sup> |
| 32    | 2nd half t <sub>0</sub>  | Applicable time of day<br>Dummy value when velocity code = 0   | Ulong  | 4            | H+120         | 16               |
| 33    | 2nd half iodp            | Issue of PRN mask data   | Ulong  | 4            | H+124         | -                |



---

| <b>Field</b> | <b>Field type</b>   | <b>Description</b>   | <b>Format</b> | <b>Binary Bytes</b> | <b>Binary Offset</b> | <b>Scaling</b> |
|--------------|---------------------|--|---------------|---------------------|----------------------|----------------|
| 34           | 2nd half corr spare | Spare value when velocity code = 0<br>Dummy value when velocity code = 1 | Ulong         | 4                   | H+128                | -              |
| 35           | xxxx                | 32-bit CRC (ASCII and Binary only)                                       | Ulong         | 4                   | H+132                | -              |
| 36           | [CR][LF]            | Sentence terminator (ASCII only)   | -             | -                   | -                    | -              |

## 3.165 SBAS26

### *Ionospheric delay corrections*

**Platform: OEM719, OEM729, OEM7500, OEM7700, OEM7720, PwrPak7, HxGN PIM7500**

SBAS26 provides vertical delays (relative to an L1 signal) and their accuracy at geographically defined IGPs identified by the BAND NUMBER and IGP number. Each message contains a band number and a block ID, which indicates the location of the IGPs in the respective band mask.

**Message ID: 985**

**Log Type: Asynch**

**Recommended Input:**

```
log SBAS26a onchanged
```

**ASCII Example:**

```
#SBAS26A,COM1,0,38.0,SATTIME,1337,417243.000,02000000,ec70,1984;134,1,2,15,27,11,25,11,23,11,19,11,16,11,16,12,15,13,16,13,29,14,30,13,27,11,27,11,24,11,19,11,16,12,2,0*3b6d6806
```



Each raw SBAS frame gives data for a specific frame decoder number. The SBAS26 message can be logged to view the data breakdown of SBAS frame 26 which contains ionospheric delay corrections

| Field | Field type                            | Description  | Format | Binary Bytes | Binary Offset |
|-------|---------------------------------------|--|--------|--------------|---------------|
| 1     | SBAS26 header                         | Log header. See <i>Messages</i> on page 25 for more information. |        | H            | 0             |
| 2     | prn                                   | Source PRN of message  | Ulong  | 4            | H             |
| 3     | band num                              | Band number  | Ulong  | 4            | H+4           |
| 4     | block id                              | Block ID   | Ulong  | 4            | H+8           |
| 5     | #pts                                  | Number of grid points with information to follow                 | Ulong  | 4            | H+12          |
| 6     | igp <sub>vde</sub>                    | IGP vertical delay estimates<br>Scaling = 0.125                  | Ulong  | 4            | H+16          |
| 7     | givei                                 | Grid ionospheric vertical error indicator                        | Ulong  | 4            | H+20          |
| 8...  | Next #pts entry = H + 16 + (#pts x 8) |  |        |              |               |

---

| <b>Field</b> | <b>Field type</b> | <b>Description</b>                 | <b>Format</b> | <b>Binary Bytes</b> | <b>Binary Offset</b> |
|--------------|-------------------|------------------------------------|---------------|---------------------|----------------------|
| 9            | iodi              | Issue of data - ionosphere         | Ulong         | 4                   | H+16+<br>(#pts x 8)  |
| 10           | spare             | 7 spare bits                       | Ulong         | 4                   | H+20+<br>(#pts x 8)  |
| 11           | xxxx              | 32-bit CRC (ASCII and Binary only) | Ulong         | 4                   | H+24+<br>(#pts x 8)  |
| 12           | [CR][LF]          | Sentence terminator (ASCII only)   | -             | -                   | -                    |

## 3.166 SBAS27

### *SBAS service message*

**Platform: OEM719, OEM729, OEM7500, OEM7700, OEM7720, PwrPak7, HxGN PIM7500**

SBAS27 messages apply only to the service provider transmitting the message. The number of service messages indicates the total number of unique SBAS27 messages for the current IODS. Each unique message for that IODS includes a sequential message number. The IODS is incremented in all messages, each time that any parameter in any SBAS27 message is changed.

**Message ID: 986**

**Log Type: Asynch**

**Recommended Input:**

log SBAS27a onchanged



Each raw SBAS frame gives data for a specific frame decoder number. The SBAS27 message can be logged to view the data breakdown of SBAS frame 27 which contains information about SBAS service messages.

| Field | Field type    | Description  | Format | Binary Bytes | Binary Offset |
|-------|---------------|--|--------|--------------|---------------|
| 1     | SBAS27 header | Log header. See <i>Messages</i> on page 25 for more information. |        | H            | 0             |
| 2     | prn           | Source PRN of message  | Ulong  | 4            | H             |
| 3     | iods          | Issue of slow corrections data                                   | Ulong  | 4            | H+4           |
| 4     | #messages     | Low-by-one count of messages                                     | Ulong  | 4            | H+8           |
| 5     | message num   | Low-by-one message number  | Ulong  | 4            | H+12          |
| 6     | priority code | Priority code  | Ulong  | 4            | H+16          |
| 7     | dudre inside  | Delta user differential range error - inside                     | Ulong  | 4            | H+20          |
| 8     | dudre outside | Delta user differential range error -outside                     | Ulong  | 4            | H+24          |
| 9...  | #reg          | Number of regions with information to follow                     | Ulong  | 4            | H+28          |
| 10    | lat1          | Coordinate 1 latitude  | Long   | 4            | H+32          |

| Field | Field type                         | Description                           | Format | Binary Bytes | Binary Offset        |
|-------|------------------------------------|---------------------------------------|--------|--------------|----------------------|
| 11    | lon1                               | Coordinate 1 longitude                | Long   | 4            | H+36                 |
| 12    | lat2                               | Coordinate 2 latitude                 | Long   | 4            | H+40                 |
| 13    | lon2                               | Coordinate 2 longitude                | Long   | 4            | H+44                 |
| 14    | shape                              | Shape where: 0 = triangle, 1 = square | Ulong  | 4            | H+48                 |
| 15    | Next #reg entry = H+32+(#reg x 20) |                                       |        |              |                      |
| 16    | Reserved                           |                                       | Ulong  | 4            | H+32+<br>(#reg x 20) |
| 17    | xxxx                               | 32-bit CRC (ASCII and Binary only)    | Ulong  | 4            | H+36+<br>(#reg x 20) |
| 18    | [CR][LF]                           | Sentence terminator (ASCII only)      | -      | -            | -                    |

## 3.167 SBAS32

### *Fast correction slots 0-10*

**Platform: OEM719, OEM729, OEM7500, OEM7700, OEM7720, PwrPak7, HxGN PIM7500**

SBAS32 are fast corrections for slots 0-10 in the mask of SBAS1, see **SBAS1** log on page 761.

**Message ID: 988**

**Log Type: Asynch**

**Recommended Input:**

log SBAS32a onchanged

**ASCII Example:**

```
#SBAS32A,COM2,0,70.5,FINE,1295,153284.000,02000240,18e9,34461;209,0,0,-
8097,0,0,0,0,-947,0,-2128,0,2570,14,0,14,14,14,14,0,14,0,14,0*58778ae5
```

| Field | Field type    | Description   | Format | Binary Bytes | Binary Offset |
|-------|---------------|---|--------|--------------|---------------|
| 1     | SBAS32 header | Log header. See <i>Messages</i> on page 25 for more information.                  |        | H            | 0             |
| 2     | prn           | Source PRN of message   | Ulong  | 4            | H             |
| 3     | iodp          | Issue of PRN mask data  | Ulong  | 4            | H+4           |
| 4     | prc0          | prc(i):<br><br>Fast corrections (-2048 to +2047) for the PRN in slot i (i = 0-10) | Long   | 4            | H+8           |
| 5     | prc1          |   | Long   | 4            | H+12          |
| 6     | prc2          |   | Long   | 4            | H+16          |
| 7     | prc3          |   | Long   | 4            | H+20          |
| 8     | prc4          |   | Long   | 4            | H+24          |
| 9     | prc5          |   | Long   | 4            | H+28          |
| 10    | prc6          |   | Long   | 4            | H+32          |
| 11    | prc7          |   | Long   | 4            | H+36          |
| 12    | prc8          |   | Long   | 4            | H+40          |
| 13    | prc9          |   | Long   | 4            | H+44          |
| 14    | prc10         |   | Long   | 4            | H+48          |

| Field | Field type | Description   | Format | Binary Bytes | Binary Offset |
|-------|------------|---|--------|--------------|---------------|
| 15    | udre0      | udre(i):<br><br>User differential range error indicator for the PRN in slot i (i = 0-10)<br><br>See <i>Table 166: Evaluation of UDREI</i> below for scaling information | Ulong  | 4            | H+52          |
| 16    | udre1      |   | Ulong  | 4            | H+56          |
| 17    | udre2      |   | Ulong  | 4            | H+60          |
| 18    | udre3      |   | Ulong  | 4            | H+64          |
| 19    | udre4      |   | Ulong  | 4            | H+68          |
| 20    | udre5      |   | Ulong  | 4            | H+72          |
| 21    | udre6      |   | Ulong  | 4            | H+76          |
| 22    | udre7      |   | Ulong  | 4            | H+80          |
| 23    | udre8      |   | Ulong  | 4            | H+84          |
| 24    | udre9      |   | Ulong  | 4            | H+88          |
| 25    | udre10     |   | Ulong  | 4            | H+92          |
| 26    | xxxx       | 32-bit CRC (ASCII and Binary only)  | Ulong  | 4            | H+96          |
| 27    | [CR][LF]   | Sentence terminator (ASCII only)  | -      | -            | -             |

**Table 166: Evaluation of UDREI**

| UDREI | UDRE Metres |
|-------|-------------|
| 0     | 0.01        |
| 1     | 0.02        |
| 2     | 0.03        |
| 3     | 0.05        |
| 4     | 0.10        |
| 5     | 0.15        |
| 6     | 0.20        |
| 7     | 0.25        |
| 8     | 0.30        |
| 9     | 0.35        |
| 10    | 0.40        |

| <b>UDREI</b> | <b>UDRE Metres</b> |
|--------------|--------------------|
| 11           | 0.45               |
| 12           | 0.50               |
| 13           | 0.60               |
| 14           | Not Monitored      |
| 15           | Do Not Use         |



## 3.168 SBAS33

### *Fast correction slots 11-21*

**Platform:** OEM719, OEM729, OEM7500, OEM7700, OEM7720, PwrPak7, HxGN PIM7500

SBAS33 are fast corrections for slots 11-21.

**Message ID:** 989

**Log Type:** Asynch

**Recommended Input:**

```
log SBAS33a onchanged
```

**ASCII Example:**

```
#SBAS33A,COM2,0,47.5,FINE,1295,158666.000,03000240,b23e,34461;209,0,0,-3343,0,0,0,-533,0,0,0,0,0,14,0,14,14,14,0,14,14,14,14,14*6d890f5f
```



Each raw mask frame gives data for a specific frame decoder number. The SBAS33 message can be logged to view the data breakdown of SBAS frame 33 which contains information about correction slots 11-21.

| Field | Field type    | Description  | Format | Binary Bytes | Binary Offset |
|-------|---------------|--|--------|--------------|---------------|
| 1     | SBAS33 header | Log header. See <i>Messages</i> on page 25 for more information. |        | H            | 0             |
| 2     | prn           | Source PRN of message  | Ulong  | 4            | H             |
| 3     | iodp          | Issue of PRN mask data   | Ulong  | 4            | H+4           |

| Field | Field type | Description  | Format   | Binary Bytes | Binary Offset |
|-------|------------|--|--|--------------|---------------|
| 4     | prc11      | prc(i):<br>Fast corrections (-2048 to +2047) for the PRN in slot i (i = 11-21) | Long   | 4            | H+8           |
| 5     | prc12      |  | Long   | 4            | H+12          |
| 6     | prc13      |  | Long   | 4            | H+16          |
| 7     | prc14      |  | Long   | 4            | H+20          |
| 8     | prc15      |  | Long   | 4            | H+24          |
| 9     | prc16      |  | Long   | 4            | H+28          |
| 10    | prc17      |  | Long   | 4            | H+32          |
| 11    | prc18      |  | Long   | 4            | H+36          |
| 12    | prc19      |  | Long   | 4            | H+40          |
| 13    | prc20      |  | Long   | 4            | H+44          |
| 14    | prc21      |  | Long   | 4            | H+48          |
| 15    | udre11     |  | udre(i):<br>User differential range error indicator for the PRN in slot i (i = 11-21)<br>See <i>Table 166: Evaluation of UDREI</i> on page 799 for scaling information | Ulong        | 4             |
| 16    | udre12     | Ulong  |  | 4            | H+56          |
| 17    | udre13     | Ulong  |  | 4            | H+60          |
| 18    | udre14     | Ulong  |  | 4            | H+64          |
| 19    | udre15     | Ulong  |  | 4            | H+68          |
| 20    | udre16     | Ulong  |  | 4            | H+72          |
| 21    | udre17     | Ulong  |  | 4            | H+76          |
| 22    | udre18     | Ulong  |  | 4            | H+80          |
| 23    | udre19     | Ulong  |  | 4            | H+84          |
| 24    | udre20     | Ulong  |  | 4            | H+88          |
| 25    | udre21     | Ulong  | 4  | H+92         |               |
| 26    | xxxx       | 32-bit CRC (ASCII and Binary only)   | Ulong  | 4            | H+96          |
| 27    | [CR][LF]   | Sentence terminator (ASCII only)   | -  | -            | -             |

## 3.169 SBAS34

### *Fast correction slots 22-32*

**Platform:** OEM719, OEM729, OEM7500, OEM7700, OEM7720, PwrPak7, HxGN PIM7500

SBAS34 are fast corrections for slots 22-32 in the mask of SBAS1, see **SBAS1** log on page 761.

**Message ID:** 990

**Log Type:** Asynch

**Recommended Input:**

```
log SBAS34a onchanged
```

**ASCII Example:**

```
#SBAS34A,COM2,0,73.0,FINE,1295,226542.000,02000040,1be8,34461;209,0,58
79,0,0,0,0,2687,0,10922,10922,10922,10922,0,14,14,14,14,0,14,15,15,15,
15*3aeb74be
```



Each raw mask frame gives data for a specific frame decoder number. The SBAS34 message can be logged to view the data breakdown of SBAS frame 34 which contains information about fast correction slots 22-32.

| Field | Field type    | Description  | Format | Binary Bytes | Binary Offset |
|-------|---------------|--|--------|--------------|---------------|
| 1     | SBAS34 header | Log header. See <i>Messages</i> on page 25 for more information. |        | H            | 0             |
| 2     | prn           | Source PRN of message  | Ulong  | 4            | H             |
| 3     | iodp          | Issue of PRN mask data   | Ulong  | 4            | H+4           |

| Field | Field type | Description  | Format   | Binary Bytes | Binary Offset |      |
|-------|------------|--|--|--------------|---------------|------|
| 4     | prc22      | prc(i):<br>Fast corrections (-2048 to +2047) for the PRN in slot i (i = 22-32) | Long   | 4            | H+8           |      |
| 5     | prc23      |  | Long   | 4            | H+12          |      |
| 6     | prc24      |  | Long   | 4            | H+16          |      |
| 7     | prc25      |  | Long   | 4            | H+20          |      |
| 8     | prc26      |  | Long   | 4            | H+24          |      |
| 9     | prc27      |  | Long   | 4            | H+28          |      |
| 10    | prc28      |  | Long   | 4            | H+32          |      |
| 11    | prc29      |  | Long   | 4            | H+36          |      |
| 12    | prc30      |  | Long   | 4            | H+40          |      |
| 13    | prc31      |  | Long   | 4            | H+44          |      |
| 14    | prc32      |  | Long   | 4            | H+48          |      |
| 15    | udre22     |  | udre(i):<br>User differential range error indicator for the PRN in slot i (i = 22-32)<br>See <i>Table 166: Evaluation of UDREI</i> on page 799 for scaling information | Ulong        | 4             | H+52 |
| 16    | udre23     |  |  | Ulong        | 4             | H+56 |
| 17    | udre24     | Ulong  |  | 4            | H+60          |      |
| 18    | udre25     | Ulong  |  | 4            | H+64          |      |
| 19    | udre26     | Ulong  |  | 4            | H+68          |      |
| 20    | udre27     | Ulong  |  | 4            | H+72          |      |
| 21    | udre28     | Ulong  |  | 4            | H+76          |      |
| 22    | udre29     | Ulong  |  | 4            | H+80          |      |
| 23    | udre30     | Ulong  |  | 4            | H+84          |      |
| 24    | udre31     | Ulong  |  | 4            | H+88          |      |
| 25    | udre32     | Ulong  | 4  | H+92         |               |      |
| 26    | xxxx       | 32-bit CRC (ASCII and Binary only)   | Ulong  | 4            | H+96          |      |
| 27    | [CR][LF]   | Sentence terminator (ASCII only)   | -  | -            | -             |      |

## 3.170 SBAS35

### *Fast correction slots 33-43*

**Platform: OEM719, OEM729, OEM7500, OEM7700, OEM7720, PwrPak7, HxGN PIM7500**

SBAS35 are fast corrections for slots 33-43 in the mask of SBAS1, see **SBAS1** log on page 761.

**Message ID: 991**

**Log Type: Asynch**

**Recommended Input:**

log SBAS35a onchanged



Each raw mask frame gives data for a specific frame decoder number. The SBAS35 message can be logged to view the data breakdown of SBAS frame 35 which contains information about fast correction slots 33-43.

| Field | Field type    | Description  | Format | Binary Bytes | Binary Offset |
|-------|---------------|--|--------|--------------|---------------|
| 1     | SBAS35 header | Log header. See <i>Messages</i> on page 25 for more information.                   |        | H            | 0             |
| 2     | prn           | Source PRN of message  | Ulong  | 4            | H             |
| 3     | iodp          | Issue of PRN mask data   | Ulong  | 4            | H+4           |
| 4     | prc33         | prc(i):<br><br>Fast corrections (-2048 to +2047) for the PRN in slot i (i = 33-43) | Long   | 4            | H+8           |
| 5     | prc34         |  | Long   | 4            | H+12          |
| 6     | prc35         |  | Long   | 4            | H+16          |
| 7     | prc36         |  | Long   | 4            | H+20          |
| 8     | prc37         |  | Long   | 4            | H+24          |
| 9     | prc38         |  | Long   | 4            | H+28          |
| 10    | prc39         |  | Long   | 4            | H+32          |
| 11    | prc40         |  | Long   | 4            | H+36          |
| 12    | prc41         |  | Long   | 4            | H+40          |
| 13    | prc42         |  | Long   | 4            | H+44          |
| 14    | prc43         |  | Long   | 4            | H+48          |

| Field | Field type | Description  | Format                             | Binary Bytes | Binary Offset |
|-------|------------|--|------------------------------------|--------------|---------------|
| 15    | udre33     | udre(i):<br><br>User differential range error indicator for the PRN in slot i (i = 33-43)<br><br>See <i>Table 166: Evaluation of UDREI</i> on page 799 for scaling information | Ulong                              | 4            | H+52          |
| 16    | udre34     |  | Ulong                              | 4            | H+56          |
| 17    | udre35     |  | Ulong                              | 4            | H+60          |
| 18    | udre36     |  | Ulong                              | 4            | H+64          |
| 19    | udre37     |  | Ulong                              | 4            | H+68          |
| 20    | udre38     |  | Ulong                              | 4            | H+72          |
| 21    | udre39     |  | Ulong                              | 4            | H+76          |
| 22    | udre40     |  | Ulong                              | 4            | H+80          |
| 23    | udre41     |  | Ulong                              | 4            | H+84          |
| 24    | udre42     |  | Ulong                              | 4            | H+88          |
| 25    | udre43     |  | Ulong                              | 4            | H+92          |
| 26    | xxxx       |  | 32-bit CRC (ASCII and Binary only) | Ulong        | 4             |
| 27    | [CR][LF]   | Sentence terminator (ASCII only)   | -                                  | -            | -             |

## 3.171 SBAS45

### *Slow corrections*

**Platform: OEM719, OEM729, OEM7500, OEM7700, OEM7720, PwrPak7, HxGN PIM7500**

Each SBAS45 message contains a 2-bit IODP indicating the associated PRN mask.

The time of applicability (T0) of the PRC is the start of the epoch of the WNT second that is coincident with the transmission at the satellite of the first bit of the message block.

**Message ID: 993**

**Log Type: Asynch**

**Recommended Input:**

```
log SBAS45a onchanged
```

**ASCII Example:**

```
#SBAS45A,COM2,0,73.0,FINE,1295,228498.000,02000040,c730,34461;209,23,3
2,197,-116,206,-1,-6,-3,-5546,3488,25,148,262,-
312,867,4,3,0,2513,3488,0*02d6e0d5
```



Each raw mask frame gives data for a specific frame decoder number. The SBAS45 message can be logged to view the data breakdown of SBAS frame 45 which contains information about slow corrections.

| Field | Field type    | Description  | Format | Binary Bytes | Binary Offset | Scaling          |
|-------|---------------|--|--------|--------------|---------------|------------------|
| 1     | SBAS45 header | Log header. See <i>Messages</i> on page 25 for more information. |        | H            | 0             | -                |
| 2     | prn           | Source PRN of message  | Ulong  | 4            | H             | -                |
| 3     | mask1         | Index into PRN mask (Type 1)                                     | Ulong  | 4            | H+4           | -                |
| 4     | iode1         | Issue of ephemeris data  | Ulong  | 4            | H+8           | -                |
| 5     | dx1           | Delta x (ECEF)   | Long   | 4            | H+12          | 0.125            |
| 6     | dy1           | Delta y (ECEF)   | Long   | 4            | H+16          | 0.125            |
| 7     | dz1           | Delta z (ECEF)   | Long   | 4            | H+20          | 0.125            |
| 8     | ddx1          | Delta delta x (ECEF)   | Long   | 4            | H+24          | 2 <sup>-11</sup> |
| 9     | ddy1          | Delta delta y (ECEF)   | Long   | 4            | H+28          | 2 <sup>-11</sup> |
| 10    | ddz1          | Delta delta z (ECEF)   | Long   | 4            | H+32          | 2 <sup>-11</sup> |

| Field | Field type         | Description                         | Format | Binary Bytes | Binary Offset | Scaling          |
|-------|--------------------|-------------------------------------|--------|--------------|---------------|------------------|
| 11    | da <sub>f0</sub> 1 | Delta a <sub>f0</sub> clock offset  | Long   | 4            | H+36          | 2 <sup>-31</sup> |
| 12    | t <sub>0</sub> 1   | Applicable time of day              | Ulong  | 4            | H+40          | 16               |
| 13    | mask2              | Second index into PRN mask (Type 1) | Ulong  | 4            | H+44          | -                |
| 14    | iode2              | Second issue of ephemeris data      | Ulong  | 4            | H+48          | -                |
| 15    | dx2                | Delta x (ECEF)                      | Long   | 4            | H+52          | 0.125            |
| 16    | dy2                | Delta y (ECEF)                      | Long   | 4            | H+56          | 0.125            |
| 17    | dz2                | Delta z (ECEF)                      | Long   | 4            | H+60          | 0.125            |
| 18    | ddx2               | Delta delta x (ECEF)                | Long   | 4            | H+64          | 2 <sup>-11</sup> |
| 19    | ddy2               | Delta delta y (ECEF)                | Long   | 4            | H+68          | 2 <sup>-11</sup> |
| 20    | ddz2               | Delta delta z (ECEF)                | Long   | 4            | H+72          | 2 <sup>-11</sup> |
| 21    | da <sub>f0</sub> 2 | Delta a <sub>f0</sub> clock offset  | Long   | 4            | H+76          | 2 <sup>-31</sup> |
| 22    | t <sub>0</sub> 2   | Applicable time of day              | Ulong  | 4            | H+80          | 16               |
| 23    | iodp               | Issue of PRN mask data              | Ulong  | 4            | H+84          | -                |
| 24    | xxxx               | 32-bit CRC (ASCII and Binary only)  | Ulong  | 4            | H+88          | -                |
| 25    | [CR][LF]           | Sentence terminator (ASCII only)    | -      | -            | -             | -                |



## 3.172 SBASALMANAC

### *SBAS Almanac collection*

**Platform: OEM719, OEM729, OEM7500, OEM7700, OEM7720, PwrPak7, HxGN PIM7500**

This log contains a collection of all current SBAS almanacs that have been decoded by the receiver and may contain almanac data for multiple PRNs. The SBASALMANAC log is populated by the GEO Almanac Message Type 17 which is available in the **SBAS17** log (see page 783). These PRNs are broken out into individual SBAS almanac entries for this message and output individually. If multiple SBAS subsystems (e.g., WAAS, EGNOS, GAGAN, MSAS) are tracked, this message will include almanac data collected from each with the subsystem identified in each message entry. The almanac data contains all of the information required to compute the satellite position as well as health and status information.

The OEM7 family of receivers automatically save almanacs in their Non-Volatile Memory (NVM), so creating an almanac boot file is not necessary.

**Message ID: 1425**

**Log Type: Asynch**

**Recommended Input:**

Log SBASALMANACA onchanged

**ASCII Example:**

```
#SBASALMANACA,COM1,2,80.0,SATTIME,1672,411186.000,02000020,84d8,43119;
133,WAAS,65600,0,0,-5571800,-41758600,-1456000,0,0,120*22da17e8
#SBASALMANACA,COM1,1,80.0,SATTIME,1672,411186.000,02000020,84d8,43119;
135,WAAS,65600,0,0,-28758600,-30825600,0,0,0,0*dd122ca1
#SBASALMANACA,COM1,0,80.0,SATTIME,1672,411186.000,02000020,84d8,43119;
138,WAAS,65600,0,0,-12547600,-40248000,0,0,0,0*89c6c51c
```

| Field | Field Type         | Description   | Format | Binary Bytes | Binary Offset |
|-------|--------------------|---|--------|--------------|---------------|
| 1     | SBASALMANAC Header | Log header. See <i>Messages</i> on page 25 for more information.                  |        | H            | 0             |
| 2     | Satellite ID       | Satellite ID  | Ulong  | 4            | H             |
| 3     | Variant            | System variant (refer to <i>Table 167: SBAS Subsystem Types</i> on the next page) | Enum   | 4            | H + 4         |
| 4     | Time               | Time of day (s)   | Ulong  | 4            | H + 8         |
| 5     | Data ID            | Data identification   | Ushort | 2            | H + 12        |
| 6     | Health             | Satellite health  | Ushort | 2            | H + 14        |

| Field | Field Type | Description                        | Format | Binary Bytes | Binary Offset |
|-------|------------|------------------------------------|--------|--------------|---------------|
| 7     | X          | ECEF X coordinate (m)              | Long   | 4            | H + 16        |
| 8     | Y          | ECEF Y coordinate (m)              | Long   | 4            | H + 20        |
| 9     | Z          | ECEF Z coordinate (m)              | Long   | 4            | H + 24        |
| 10    | X Velocity | X rate of change (m/s)             | Long   | 4            | H + 28        |
| 11    | Y Velocity | Y rate of change (m/s)             | Long   | 4            | H + 32        |
| 12    | Z Velocity | Z rate of change (m/s)             | Long   | 4            | H + 36        |
| 13    | CRC        | 32-bit CRC (ASCII and binary only) | Ulong  | 4            | H + 40        |
| 14    | [CR][LF]   | Sentence terminator (ASCII only)   | -      | -            | -             |

**Table 167: SBAS Subsystem Types**

| ASCII   | Binary | Description    |
|---------|--------|----------------|
| NONE    | 0      | No system      |
| UNKNOWN | 1      | Unknown system |
| WAAS    | 2      | WAAS system    |
| EGNOS   | 3      | EGNOS system   |
| MSAS    | 4      | MSAS system    |
| GAGAN   | 5      | GAGAN system   |
| QZSS    | 7      | QZSS System    |

### 3.173 SOFTLOADSTATUS

*Describes the status of the SoftLoad process*

**Platform: OEM719, OEM729, OEM7500, OEM7700, OEM7720, PwrPak7, HxGN PIM7500**

This log describes the status of the SoftLoad process.



Status values  $\geq 16$  (ERROR) indicate that an error has occurred during the loading process. Status  $< 16$  (ERROR) are part of normal SoftLoad operation.

**Message ID: 1235**

**Log Type: Asynch**

**Recommended Input:**

```
log softloadstatusa onchanged
```

**ASCII Example:**

```
#SOFTLOADSTATUSA,COM1,0,97.5,UNKNOWN,0,0.113,024c0001,2d64,10481;NOT_STARTED*827fdc04
```

| Field | Field Type            | Description   | Format | Binary Bytes | Binary Offset |
|-------|-----------------------|---|--------|--------------|---------------|
| 1     | SOFTLOADSTATUS header | Log header. See <i>Messages</i> on page 25 for more information.                | -      | H            | 0             |
| 2     | status                | Status of the SoftLoad process see <i>Table 168: SoftLoad Status Type</i> below | Enum   | 4            | H             |
| 3     | xxxx                  | 32-bit CRC (ASCII and Binary only)  | Ulong  | 4            | H+4           |
| 4     | [CR][LF]              | Sentence terminator (ASCII only)  | -      | -            | -             |

**Table 168: SoftLoad Status Type**

| Value | Name            | Description  |
|-------|-----------------|--|
| 1     | NOT_STARTED     | SoftLoad process has not begun   |
| 2     | READY_FOR_SETUP | SoftLoad process is ready to receive setup information in the form of the <b>SOFTLOADSETUP</b> command or <b>SOFTLOADSREC</b> command with S0 records. Once sufficient setup data has been sent, the process is also ready for the <b>SOFTLOADDATA</b> command |

| Value | Name                    | Description  |
|-------|-------------------------|--|
| 3     | READY_FOR_DATA          | SoftLoad process is ready to receive data in the form of the <b>SOFTLOADDATA</b> command or <b>SOFTLOADSREC</b> command with S3 records. Once all data has been sent, send the <b>SOFTLOADCOMMIT</b> command |
| 4     | DATA_VERIFIED           | SoftLoad data has passed CRC. This status occurs after a <b>SOFTLOADCOMMIT</b> command   |
| 5     | WRITING_FLASH           | SoftLoad data is being written to flash. This status occurs after a <b>SOFTLOADCOMMIT</b> command. During a firmware upload, the receiver may remain in this state for 300 seconds or longer                 |
| 6     | WROTE_FLASH             | SoftLoad data has been written to flash  |
| 7     | WROTE_AUTHCODE          | The embedded AuthCode was successfully written   |
| 8     | COMPLETE                | SoftLoad process has completed. The next step is to send the <b>RESET</b> command to reset the receiver  |
| 9     | VERIFYING_DATA          | SoftLoad is verifying the downloaded image   |
| 10    | COPIED_SIGNATURE_AUTH   | Signature AuthCodes have been copied from the current firmware to the downloaded firmware.   |
| 11    | WROTE_TRANSACTION_TABLE | The downloaded firmware has been activated and will be executed if the receiver is reset. This status is effectively identical to COMPLETE.  |
| 16    | ERROR                   | Indicates an internal error in the SoftLoad process. This error is not expected to occur. Contact NovAtel Customer Support for assistance.   |
| 17    | RESET_ERROR             | Error resetting SoftLoad. Reset the receiver and restart the SoftLoad process.   |
| 18    | BAD_SRECORD             | A bad S Record was received. Ensure that S Records are enclosed in double quotes within the <b>SOFTLOADSREC</b> command (see page 353).  |
| 19    | BAD_PLATFORM            | This data cannot be loaded onto this platform. Ensure that the correct *.shex file for the platform is being used.   |
| 20    | BAD_MODULE              | This module cannot be loaded with SoftLoad. This file must be loaded using WinLoad or a similar loader.  |
| 21    | BAD_AUTHCODE            | Bad AuthCode received for this PSN   |
| 22    | NOT_READY_FOR_SETUP     | A <b>SOFTLOADSETUP</b> command was entered before a <b>SOFTLOADRESET</b> command or after a <b>SOFTLOADDATA</b> command  |

| Value | Name                 | Description   |
|-------|----------------------|---|
| 23    | NO_MODULE            | No data type was entered before a <b>SOFTLOADDATA</b> command was received. Set the data type using the <b>SOFTLOADSETUP</b> command or <b>SOFTLOADSREC</b> command with an "S0~T~" S Record. |
| 24    | NO_PLATFORM          | No platform was entered before a <b>SOFTLOADDATA</b> command was received. Set the platform using the <b>SOFTLOADSETUP</b> command or <b>SOFTLOADSREC</b> command with an "S0~P~" S Record.   |
| 25    | NOT_READY_FOR_DATA   | A <b>SOFTLOADDATA</b> command was received but the receiver was not ready for it  |
| 26    | MODULE_MISMATCH      | The SoftLoad data module was changed in the middle of loading. Restart the SoftLoad process using the <b>SOFTLOADRESET</b> command (see page 350).  |
| 27    | OUT_OF_MEMORY        | SoftLoad has run out of RAM to store the incoming data. Reset the receiver and restart the SoftLoad process.  |
| 28    | DATA_OVERLAP         | SoftLoad data has overlapped. Ensure that the correct address and length is set in the <b>SOFTLOADDATA</b> command or <b>SOFTLOADSREC</b> command.  |
| 29    | BAD_IMAGE_CRC        | CRC of the downloaded image has failed. Ensure that all content from the *.shex file has been successfully downloaded.  |
| 30    | IMAGE_OVERSIZE       | The downloaded image is too big for the intended data module  |
| 31    | AUTHCODE_WRITE_ERROR | An error occurred when writing the embedded AuthCode to flash   |
| 32    | BAD_FLASH_ERASE      | Erasing of the flash failed. This could indicate a failure in the flash hardware.   |
| 33    | BAD_FLASH_WRITE      | Writing to the flash failed. This could indicate a failure in the flash hardware.   |
| 34    | TIMEOUT              | SoftLoad time out has occurred  |

## 3.174 SOURCETABLE

### *NTRIP source table entries*

**Platform: OEM729, OEM7700, OEM7720, PwrPak7**

This log outputs the NTRIP SOURCETABLE entries from the NTRIPCASTER set by the **NTRIPSOURCETABLE** command (see page 246). The entry data field in the first entry is always the header of the retrieved SOURCETABLE. The entry data field in the last entry is always a string "ENDSOURCETABLE" which indicates the end of the source table. Entries in between these fields are the real SOURCETABLE entries.

**Message ID: 1344**

**Log Type: Polled**

**Recommended Input:**

```
log sourcetablea once
```

#### **ASCII Example:**

```
#SOURCETABLEA,COM1,17,84.0,COARSESTEERING,1933,497547.000,02400020,71d
d,32768;"hera.novatel.com:2101",0,0,"HTTP/1.1 200 OK;Ntrip-Version:
Ntrip/2.0;Ntrip-Flags: st_filter,st_auth,st_match,st_strict,rtsp,plain_
rtp;Server: NTRIP Caster/2.0.15;Date: Fri, 27 Jan 2017 18:12:01
GMT;Connection: close;Content-Type: gnss/sourcetable;Content-Length:
2057"*87a7d39d

#SOURCETABLEA,COM1,16,84.0,COARSESTEERING,1933,497547.000,02400020,71d
d,32768;"hera.novatel.com:2101",0,0,"CAS;hera.novatel.ca;80,2101;NovAt
el;NovAtel;0;CAN;51;-115;http://www.novatel.com"*e3ec11a0

#SOURCETABLEA,COM1,15,84.0,COARSESTEERING,1933,497547.000,02400020,71d
d,32768;"hera.novatel.com:2101",0,0,"NET;GREF;NovAtel;B;N;http://novat
el.com;none;novatel.com;none"*2a6b50eb

#SOURCETABLEA,COM1,14,84.0,COARSESTEERING,1933,497547.000,02400020,71d
d,32768;"hera.novatel.com:2101",0,0,"STR;novatel_rtcmv3;Office Roof
DL1L2;RTCM 3.0;1033(10),1005(10),1019(60),1020(60),1003(1),1011
(1);2;GPS+GLO;NovAtel;CAN;51;-115;0;0;NovAtel
OEM628;none;B;N;9600;Test"*8a7c760f

#SOURCETABLEA,COM1,13,84.0,COARSESTEERING,1933,497547.000,02400020,71d
d,32768;"hera.novatel.com:2101",0,0,"STR;novatel_rtcv;Office Roof
DL1L2;RTCM 2.3;1(1),3(10),31(1),32(10);0;GPS+GLO;NovAtel;CAN;51;-
115;0;0;NovAtel OEM628;none;B;N;9600;Test"*08c57cb7

#SOURCETABLEA,COM1,12,84.0,COARSESTEERING,1933,497547.000,02400020,71d
d,32768;"hera.novatel.com:2101",0,0,"STR;novatel_rtca;Office Roof
DL1L2;RTCA;RTCAREF(10),RTCA1(1),RTCAEPHEM(60);0;GPS;NovAtel;CAN;51;-
115;0;0;NovAtel OEM628;none;B;N;9600;Test"*006997bc

#SOURCETABLEA,COM1,11,84.0,COARSESTEERING,1933,497547.000,02400020,71d
d,32768;"hera.novatel.com:2101",0,0,"STR;novatel_cmr;Office Roof
```

```
DL1L2;CMR;CMRREF(10),CMROBS(1),CMRGLOBS(1);2;GPS+GLO;NovAtel;CAN;51;-115;0;0;NovAtel OEM628;none;B;N;9600;Test"*0955ccb7

#SOURCETABLEA,COM1,10,84.0,COARSESTEERING,1933,497547.000,02400020,71dd,32768;"hera.novatel.com:2101",0,0,"STR;novatel_rtcaobs2;Office Roof DL1L2;RTCA;rtcaref(10),rtcaobs2(1),rtcaephem(60);2;GPS+GLO;NovAtel;CAN;51;-115;0;0;NovAtel OEM628;none;B;N;9600;Test"*426e39a5

#SOURCETABLEA,COM1,9,84.0,COARSESTEERING,1933,497547.000,02400020,71dd,32768;"hera.novatel.com:2101",0,0,"STR;novatel_cmrplus;Office Roof DL1L2;CMR+;cmrplus(1),cmrobs(1),cmrglobs(1);2;GPS+GLO;NovAtel;CAN;51;-115;0;0;NovAtel OEM628;none;B;N;9600;Test"*2d5ba56e

#SOURCETABLEA,COM1,8,84.0,COARSESTEERING,1933,497547.000,02400020,71dd,32768;"hera.novatel.com:2101",0,0,"STR;novatel_rtc2021;Office Roof DL1L2;RTCM 2.3;3(10),2021(1);2;GPS+GLO;NovAtel;CAN;51;-115;0;0;NovAtel OEM628;none;B;N;9600;Test"*d82df5de

#SOURCETABLEA,COM1,7,84.0,COARSESTEERING,1933,497547.000,02400020,71dd,32768;"hera.novatel.com:2101",0,0,"STR;novatel_1819;Office Roof DL1L2;RTCM 2.3;3(10),22(10),23(60),24(60),1819(1);2;GPS+GLO;NovAtel;CAN;51;-115;0;0;NovAtel OEM628;none;B;N;9600;Test"*7aead153

#SOURCETABLEA,COM1,6,84.0,COARSESTEERING,1933,497547.000,02400020,71dd,32768;"hera.novatel.com:2101",0,0,"STR;novatel_rtcaobs;Office Roof DL1L2;RTCA;rtcaref(10),rtcaobs(1),rtcaephem(60);2;GPS+GLO;NovAtel;CAN;51;-115;0;0;NovAtel OEM628;none;B;N;9600;Test"*530a51c4

#SOURCETABLEA,COM1,5,84.0,COARSESTEERING,1933,497547.000,02400020,71dd,32768;"hera.novatel.com:2101",0,0,"STR;novatel_novatelx;Office Roof;NovatelX;novatelobs;2;GPS+GLO;NovAel;CAN;51;-114;0;0;NovAtel OEM628;none;B;N;9600;Test"*4438c2e2

#SOURCETABLEA,COM1,4,84.0,COARSESTEERING,1933,497547.000,02400020,71dd,32768;"hera.novatel.com:2101",0,0,"STR;Hyderabad1;hyderabad test1;unknown;unknown;2;GPS+GLO;NovAtel;INDIA;17;78;0;0;NovAtel OEM628;none;B;N;9600;Test"*de6c19f0

#SOURCETABLEA,COM1,3,84.0,COARSESTEERING,1933,497547.000,02400020,71dd,32768;"hera.novatel.com:2101",0,0,"STR;Hyderabad2;hyderabad test1;unknown;unknown;2;GPS+GLO;NovAtel;INDIA;17;78;0;0;NovAtel OEM628;none;B;N;9600;Test"*27e9eeel

#SOURCETABLEA,COM1,2,84.0,COARSESTEERING,1933,497547.000,02400020,71dd,32768;"hera.novatel.com:2101",0,0,"STR;Hyderabad3;hyderabad test1;unknown;unknown;2;GPS+GLO;NovAtel;INDIA;17;78;0;0;NovAtel OEM628;none;B;N;9600;Test"*3ed5941b

#SOURCETABLEA,COM1,1,84.0,COARSESTEERING,1933,497547.000,02400020,71dd,32768;"hera.novatel.com:2101",0,0,"STR;Hyderabad4;hyderabad test1;unknown;unknown;2;GPS+GLO;NovAtel;INDIA;17;78;0;0;NovAtel OEM628;none;B;N;9600;Test"*a3a188e2
```

```
#SOURCETABLEA,COM1,0,84.0,COARSESTEERING,1933,497547.000,02400020,71dd,32768;"hera.novatel.com:2101",0,0,"ENDSOURCETABLE"*7758fba9
```

| Field | Field Type         | Description  | Format                                    | Binary Bytes   | Binary Offset |
|-------|--------------------|--|---|----------------|---------------|
| 1     | SOURCETABLE header | Log header. See <i>Messages</i> on page 25 for more information. |   | H              | 0             |
| 2     | endpoint           | NTRIPCASTER Endpoint   | String with varied length up to 80 bytes  | a <sup>1</sup> | H             |
| 3     | Reserved1          | reserved   | Ulong                                     | 4              | H+a           |
| 4     | Reserved2          | reserved   | Ulong                                     | 4              | H+a+4         |
| 5     | Entry data         | Source table entry data  | String with varied length up to 512 bytes | b <sup>1</sup> | H+a+8         |
| 6     | xxxx               | 32-bit CRC (ASCII and binary only)                               | Ulong                                     | 4              | H+a+b+8       |
| 7     | [CR][LF]           | Sentence terminator (ASCII only)                                 | -   | -              | -             |

<sup>1</sup>In the binary case, each string field needs to be NULL terminated and additional bytes of padding added to maintain 4-byte alignment, up to the maximum defined by the string size. The next defined field starts immediately at the next 4-byte alignment following the NULL.



## 3.175 TERRASTARINFO

### *TerraStar subscription information*

**Platform: OEM719, OEM729, OEM7500, OEM7700, OEM7720, PwrPak7, HxGN PIM7500**

This log contains details on the TerraStar subscription.

**Message ID: 1719**

**Log Type: Asynch**

**Recommended Input:**

```
log terrastarinfa onchanged
```

**ASCII Example:**

```
#TERRASTARINFOA,COM1,0,65.5,UNKNOWN,0,1.168,02040008,E776,13260;"QR391:3006:6179",TERM,00000301,167,2015,0,NONE,0.00000,0.00000,0*7E4A9EC0
```

| Field | Field type               | Description   | Format    | Binary Bytes | Binary Offset |
|-------|--------------------------|---|-----------|--------------|---------------|
| 1     | TERRASTAR INFO header    | Log header. See <i>Messages</i> on page 25 for more information.  |           | H            | 0             |
| 2     | PAC                      | Product activation code   | Char [16] | 16           | H             |
| 3     | Type                     | Subscription type (see <i>Table 169: TerraStar Subscription Type</i> on the next page)  | Enum      | 4            | H+16          |
| 4     | Subscription permissions | Services permitted by the subscription (see <i>Table 170: TerraStar Subscription Details Mask</i> on the next page)<br><b>Note:</b> Bits in the Reserved areas of this field may be set, but the Reserved bits should be ignored.   | Hex       | 4            | H+20          |
| 5     | Service End Day          | Day of the year when the subscription ends. Service ends at 00:00 UTC on this day.<br>For example, if the TerraStar service end date/time is 2015-06-15 00:01:05 HRS UTC (DOY = 166), then the Service End DOY will indicate it as 167 and Service End Year will indicate it as 2015. | Ulong     | 4            | H+24          |
| 6     | Service End Year         | Year that subscription ends   | Ulong     | 4            | H+28          |

| Field | Field type             | Description   | Format | Binary Bytes | Binary Offset |
|-------|------------------------|---|--------|--------------|---------------|
| 7     | Reserved               |   | Ulong  | 4            | H+32          |
| 8     | Region restriction     | For region restricted subscriptions, the type of region restriction (see <i>Table 171: TerraStar Region Restriction</i> on the next page) | Enum   | 4            | H+36          |
| 9     | Center point latitude  | For local area subscriptions, the center point latitude (degrees)   | Float  | 4            | H+40          |
| 10    | Center point longitude | For local area subscriptions, the center point longitude (degrees)  | Float  | 4            | H+44          |
| 11    | Radius                 | For local area subscriptions, the maximum permitted distance from center point (kilometers)   | Ulong  | 4            | H+48          |
| 12    | xxxx                   | 32-bit CRC (ASCII and Binary only)  | Ulong  | 4            | H+52          |
| 13    | [CR][LF]               | Sentence terminator (ASCII only)  | -      | -            | -             |

**Table 169: TerraStar Subscription Type**

| ASCII                     | Binary | Description  |
|---------------------------|--------|--|
| UNASSIGNED                | 0      | Decoder has not had an assigned operating mode   |
| TERM                      | 1      | Term subscription  |
| MODEL                     | 5      | Receiver is operating with an RTK assist enabled model and there is not an active TerraStar subscription installed |
| BUBBLE                    | 100    | Receiver is operating in a TerraStar-permitted subscription-free bubble  |
| INCOMPATIBLE_SUBSCRIPTION | 104    | Subscription is incompatible with this version of firmware   |

**Table 170: TerraStar Subscription Details Mask**

| Bit   | Mask       | Description         |
|-------|------------|---------------------|
| 0-8   | 0x000001FF | Reserved            |
| 9     | 0x00000200 | TerraStar-C service |
| 10    | 0x00000400 | TerraStar-L service |
| 11    | 0x00000800 | RTK ASSIST service  |
| 12-31 | 0xFFFFF000 | Reserved            |

**Table 171: TerraStar Region Restriction**

| <b>ASCII</b> | <b>Binary</b> | <b>Description</b>  |
|--------------|---------------|---|
| NONE         | 0             | TerraStar operation has no region restrictions.   |
| GEOGATED     | 1             | TerraStar operation limited to on-land<br>GEOGATED is also the default value reported if there is no subscription |
| LOCAL_AREA   | 2             | TerraStar operation limited to radius from local area center point  |
| NEARSHORE    | 3             | TerraStar operation limited to on land and near shore (coastal) regions   |

## 3.176 TERRASTARSTATUS

### *TerraStar decoder and subscription status*

**Platform:** OEM719, OEM729, OEM7500, OEM7700, OEM7720, PwrPak7, HxGN PIM7500

This log contains status information for the TerraStar decoder and subscription.

**Message ID:** 1729

**Log Type:** Asynch

**Recommended Input:**

```
log terrastarstatusa onchanged
```

**ASCII Example:**

```
#TERRASTARSTATUSA,COM1,0,49.5,FINESTEERING,1769,332336.443,02000000,fd  
c1,12602;ENABLE,LOCKED,0,DISABLED,ONSHORE*555155a5
```

| Field | Field type              | Description   | Format | Binary Bytes | Binary Offset |
|-------|-------------------------|---|--------|--------------|---------------|
| 1     | TERRASTAR STATUS header | Log header. See <i>Messages</i> on page 25 for more information.  |        | H            | 0             |
| 2     | Access                  | Access status. ENABLE (1) if the subscription is valid; DISABLE (0) otherwise   | Enum   | 4            | H             |
| 3     | Sync state              | Decoder data synchronization state (see <i>Table 172: Decoder Data Synchronization State</i> on the next page)  | Enum   | 4            | H+4           |
| 4     | Reserved                |   | Ulong  | 4            | H+8           |
| 5     | Local area status       | For local-area subscriptions, indicates if the receiver is within the permitted area (see <i>Table 173: TerraStar Local Area Status</i> on the next page) | Enum   | 4            | H+12          |
| 6     | Geogating status        | Geogating status (see <i>Table 174: TerraStar Geogating Status</i> on the next page)  | Enum   | 4            | H+16          |
| 7     | xxxx                    | 32-bit CRC (ASCII and Binary only)  | Ulong  | 4            | H+20          |
| 8     | [CR][LF]                | Sentence terminator (ASCII only)  | -      | -            | -             |

**Table 172: Decoder Data Synchronization State**

| ASCII     | Binary | Description  |
|-----------|--------|--|
| NO_SIGNAL | 0      | None of the decoders have received data in the last 30 seconds         |
| SEARCH    | 1      | At least one decoder is receiving data and is searching for the format |
| LOCKED    | 2      | At lease one decoder has locked onto the format                        |

**Table 173: TerraStar Local Area Status**

| ASCII                | Binary | Description  |
|----------------------|--------|--|
| DISABLED             | 0      | The subscription is not restricted to a local area.<br>This is also the value when there is no subscription. |
| WAITING_FOR_POSITION | 1      | Waiting for a position   |
| RANGE_CHECK          | 16     | Checking position against local area region restriction  |
| IN_RANGE             | 129    | Receiver is within the permitted local area  |
| OUT_OF_RANGE         | 130    | Receiver is outside the permitted local area   |
| POSITION_TOO_OLD     | 255    | Position is too old  |

**Table 174: TerraStar Geogating Status**

| ASCII                | Binary | Description  |
|----------------------|--------|--|
| DISABLED             | 0      | The subscription is restricted to a local area or there is no region restriction.<br>This is also the value when there is no subscription. |
| WAITING_FOR_POSITION | 1      | Waiting for a position   |
| ONSHORE              | 129    | Receiver is over land  |
| OFFSHORE             | 130    | Receiver is over water   |
| POSITION_TOO_OLD     | 255    | Position is too old  |
| PROCESSING           | 1000   | Geogater is determining status   |

## 3.177 TIME

### *Time data*

**Platform: OEM719, OEM729, OEM7500, OEM7700, OEM7720, PwrPak7, HxGN PIM7500**

This log provides several time related pieces of information including receiver clock offset and UTC time and offset. It can also be used to determine any offset in the PPS signal relative to GPS reference time.

To find any offset in the PPS signal, log the TIME log 'ontime' at the same rate as the PPS output. For example, if the PPS output is configured to output at a rate of 0.5 seconds (see the **PPSCONTROL** command on page 267) log the TIME log 'ontime 0.5' as follows:

```
log time ontime 0.5
```

The TIME log offset field can then be used to determine any offset in PPS output relative to GPS reference time.

**Message ID: 101**

**Log Type: Synch**

**Recommended Input:**

```
log timea ontime 1
```

**ASCII Example:**

```
#TIMEA, COM1, 0, 86.5, FINESTEERING, 1930, 428348.000, 02000020, 9924, 32768;VA  
LID, 1.667187222e-10, 9.641617960e-10, -  
18.000000000000, 2017, 1, 5, 22, 58, 50000, VALID*2a066e78
```



1. Consider the case where you used the **ADJUST1PPS** command (see page 54) to synchronize two receivers in a primary/secondary relationship to a common external clock. You can use the TIME log after the clock model status is valid to monitor the time difference between the Primary and Secondary receivers.
2. The header of the TIME log gives you the GPS reference time (the week number since January 5th, 1980) and the seconds into that week. The TIME log outputs the UTC offset (offset of GPS reference time from UTC time) and the receiver clock offset from GPS reference time.

If you want the UTC time in weeks and seconds, take the week number from the header. Then take the seconds into that week, also from the header, and add the correction to the seconds using the 2 offsets. Ensure not to go negative or rollover (go over the total number of seconds, 604800, in a week). In the case of a rollover, add a week and the left over seconds become the seconds into this new week. If negative, subtract a week and the remainder from the seconds of that week become the seconds into this new week.

For example:

```
TIME COM1 0 73.5 FINESTEERING 1432 235661.000 02000000 9924 2616 VALID
-0.000000351 0.000000214 -14.00000000106 2007 6 19 17 27 27000 VALID
```

From the time information above:

GPS reference time = 1432 (GPS reference week), 235661.000 (GPS seconds) from the header.

From the description in *UTC offset* row in the following table:

UTC time = GPS reference time + offset + UTC offset  
UTC time

= week 1432, 235661.000 s - 0.000000351 (offset) - 14.00000000106 (UTC offset)  
= week 1432, seconds 235646.99999964794

| Field | Field type   | Description  | Format | Binary Bytes | Binary Offset |
|-------|--------------|--|--------|--------------|---------------|
| 1     | TIME header  | Log header. See <i>Messages</i> on page 25 for more information.   |        | H            | 0             |
| 2     | clock status | Clock model status (not including current measurement data), see <i>Table 86: Clock Model Status</i> on page 446   | Enum   | 4            | H             |
| 3     | offset       | Receiver clock offset in seconds from GPS reference time. A positive offset implies that the receiver clock is ahead of GPS reference time. To derive GPS reference time, use the following formula: GPS reference time = receiver time - offset | Double | 8            | H+4           |
| 4     | offset std   | Receiver clock offset standard deviation (s)   | Double | 8            | H+12          |

| Field | Field type | Description   | Format | Binary Bytes | Binary Offset |
|-------|------------|---|--------|--------------|---------------|
| 5     | utc offset | The offset of GPS reference time from UTC time, computed using almanac parameters. UTC time is GPS reference time plus the current UTC offset plus the receiver clock offset: UTC time = GPS reference time + offset + UTC offset | Double | 8            | H+20          |
| 6     | utc year   | UTC year  | Ulong  | 4            | H+28          |
| 7     | utc month  | UTC month (0-12)<br>If UTC time is unknown, the value for month is 0.   | Uchar  | 1            | H+32          |
| 8     | utc day    | UTC day (0-31)<br>If UTC time is unknown, the value for day is 0.   | Uchar  | 1            | H+33          |
| 9     | utc hour   | UTC hour (0-23)   | Uchar  | 1            | H+34          |
| 10    | utc min    | UTC minute (0-59)   | Uchar  | 1            | H+35          |
| 11    | utc ms     | UTC millisecond (0-60999)<br>Maximum of 60999 when leap second is applied.  | Ulong  | 4            | H+36          |
| 12    | utc status | UTC status<br>0 = Invalid<br>1 = Valid<br>2 = Warning <sup>1</sup>  | Enum   | 4            | H+40          |
| 13    | xxxx       | 32-bit CRC (ASCII and Binary only)  | Ulong  | 4            | H+44          |
| 14    | [CR][LF]   | Sentence terminator (ASCII only)  | -      | -            | -             |

<sup>1</sup>Indicates that the leap second value is used as a default due to the lack of an almanac.



## 3.178 TIMESYNC

### *Synchronize time between GNSS receivers*

**Platform:** OEM719, OEM729, OEM7500, OEM7700, OEM7720, PwrPak7, HxGN PIM7500

The TIMESYNC log is used in conjunction with the **ADJUST1PPS** command (see page 54) to synchronize the time between GNSS receivers.

**Message ID:** 492

**Log Type:** Synch

**Recommended Input:**

```
log timesynca ontime 1
```

**ASCII Example:**

```
#TIMESYNCA,COM1,0,46.0,FINESTEERING,1337,410095.000,02000000,bd3f,1984;1337,410095000,FINESTEERING*aa2025db
```



The time data embedded in this log represents the time of the most recent 1PPS signal. The receiver issues this log from a communications port within 200 ms of the last 1PPS event. The 200 ms value is a "worst case scenario." Refer to *Figure 2: 1PPS Alignment* on page 55 to see the alignment between a Fine and a Cold Clock receiver. Also refer to the *Transfer Time Between Receivers* section in the [OEM7 Installation and Operation User Manual](#).

| Field | Field type      | Description  | Format | Binary Bytes | Binary Offset |
|-------|-----------------|--|--------|--------------|---------------|
| 1     | TIMESYNC header | Log header. See <i>Messages</i> on page 25 for more information.                     |        | H            | 0             |
| 2     | week            | GPS reference week number  | Ulong  | 4            | H             |
| 3     | ms              | Number of milliseconds into the GPS reference week                                   | Ulong  | 4            | H+4           |
| 4     | time status     | GPS reference time Status, see <i>Table 11: GPS Reference Time Status</i> on page 47 | Enum   | 4            | H+8           |
| 5     | xxxx            | 32-bit CRC (ASCII and Binary only)   | Ulong  | 4            | H+12          |
| 6     | [CR][LF]        | Sentence terminator (ASCII only)   | -      | -            | -             |

## 3.179 TRACKSTAT

### *Tracking status*

**Platform: OEM719, OEM729, OEM7500, OEM7700, OEM7720, PwrPak7, HxGN PIM7500**

The TRACKSTAT log contains an entry for each channel. If there are multiple signal channels for one satellite (for example L1, L2 P(Y), L2C, and L5 for GPS), then there will be multiple entries for that satellite.

As shown in *Table 123: Channel Tracking Status* on page 662 these entries can be differentiated by bit 20, which is set if there are multiple observables for a given satellite, and bits 21-25, which denote the signal type for the observation.

A zero in the PRN/slot of the TRACKSTAT log indicates the channel should be considered idle with the exception of those for GLONASS. A GLONASS channel should only be considered idle if the tracking state is 0 in the channel tracking status word.



For dual antenna receivers, a TRACKSTAT\_1 log can be requested to get TRACKSTAT data from the second antenna. As described in *Table 3: Binary Message Header Structure* on page 30, the message type indicates the log is from the second antenna. To request an ASCII log enter TRACKSTATA\_1 and for a binary log enter TRACKSTATB\_1.

**Message ID: 83**

**Log Type: Synch**

**Recommended Input:**

```
log trackstata ontime 1
```

**ASCII Example:**

```
#TRACKSTATA,COM1,0,49.5,FINESTEERING,1337,410139.000,02000000,457c,198
4;SOL_COMPUTED,PSRDIFF,5.0,30,
1,0,18109c04,21836080.582,-2241.711,50.087,1158.652,0.722,GOOD,0.973,
1,0,11309c0b,21836083.168,-1746.788,42.616,1141.780,0.000,OBSL2,0.000,
30,0,18109c24,24248449.644,-2588.133,45.237,939.380,-0.493,GOOD,0.519,
30,0,11309c2b,24248452.842,-2016.730,38.934,939.370,0.000,OBSL2,0.000,
...
14,0,18109da4,24747286.206,-3236.906,46.650,1121.760,-0.609,GOOD,0.514,
14,0,11309dab,24747288.764,-2522.270,35.557,1116.380,0.000,OBSL2,0.000,
0,0,0c0221c0,0.000,0.000,0.047,0.000,0.000,NA,0.000,
0,0,0c0221e0,0.000,0.000,0.047,0.000,0.000,NA,0.000*255a732e
```

| Field | Field Type       | Description  | Format | Binary Bytes | Binary Offset |
|-------|------------------|--|--------|--------------|---------------|
| 1     | TRACKSTAT header | Log header. See <i>Messages</i> on page 25 for more information. |        | H            | 0             |

| Field | Field Type                           | Description  | Format | Binary Bytes | Binary Offset         |
|-------|--------------------------------------|--|--------|--------------|-----------------------|
| 2     | sol status                           | Solution status (see <i>Table 73: Solution Status</i> on page 419)   | Enum   | 4            | H                     |
| 3     | pos type                             | Position type (see <i>Table 74: Position or Velocity Type</i> on page 420)   | Enum   | 4            | H+4                   |
| 4     | cutoff                               | GPS tracking elevation cut-off angle   | Float  | 4            | H+8                   |
| 5     | # chans                              | Number of hardware channels with information to follow   | Ulong  | 4            | H+12                  |
| 6     | PRN/slot                             | Satellite PRN number of range measurement<br>Refer to <i>PRN Numbers</i> on page 46  | Short  | 2            | H+16                  |
| 7     | glofreq                              | (GLONASS Frequency + 7), see <i>GLONASS Slot and Frequency Numbers</i> on page 45  | Short  | 2            | H+18                  |
| 8     | ch-tr-status                         | Channel tracking status (see <i>Table 123: Channel Tracking Status</i> on page 662)  | Ulong  | 4            | H+20                  |
| 9     | psr                                  | Pseudorange (m) - if this field is zero but the channel tracking status in the previous field indicates that the card is phase locked and code locked, the pseudorange has not been calculated yet | Double | 8            | H+24                  |
| 10    | Doppler                              | Doppler frequency (Hz)   | Float  | 4            | H+32                  |
| 11    | C/No                                 | Carrier to noise density ratio (dB-Hz)   | Float  | 4            | H+36                  |
| 12    | locktime                             | Number of seconds of continuous tracking (no cycle slips)  | Float  | 4            | H+40                  |
| 13    | psr res                              | Pseudorange residual from pseudorange filter (m)   | Float  | 4            | H+44                  |
| 14    | reject                               | Range reject code from pseudorange filter (see <i>Table 79: Observation Statuses</i> on page 426)  | Enum   | 4            | H+48                  |
| 15    | psr weight                           | Pseudorange filter weighting   | Float  | 4            | H+52                  |
| 16... | Next PRN offset = H+16+(#chans x 40) |  |        |              |                       |
| 17    | xxxx                                 | 32-bit CRC (ASCII and Binary only)   | Ulong  | 4            | H+16<br>(#chans x 40) |
| 18    | [CR][LF]                             | Sentence terminator (ASCII only)   | -      | -            | -                     |

## 3.180 TRANSFERPORTSTATUS

### *Display state of USB transfer port*

**Platform:** PwrPak7

This log displays the current state of the USB transfer port.

**Message ID:** 2114

**Log Type:** Asynch

**Recommended Input:**

```
log transferportstatusa onchanged
```

**ASCII Example:**

```
#TRANSFERPORTSTATUSA,COM1,0,82.0,COARSESTEERING,1738,399162.010,004000
20,820b,44894;0,0,0,"",""*76ec6431
```

| Field | Field Type                | Description   | Format | Binary Bytes | Binary Offset |
|-------|---------------------------|---|--------|--------------|---------------|
| 1     | TRANSFERPORTSTATUS header | Log header. See <i>Messages</i> on page 25 for more information.              | -      | H            | 0             |
| 2     | USB Detection Type        | Type of connection detected<br>See <i>Table 175: USB Detection Type</i> below | Enum   | 4            | H             |
| 3     | USB Mode                  | Current USB operation mode<br>See <i>Table 176: USB Mode</i> on the next page | Enum   | 4            | H+4           |
| 4     | xxxx                      | 32-bit CRC (ASCII and Binary only)  | Hex    | 4            | H+8           |
| 5     | [CR][LF]                  | Sentence terminator (ASCII only)  | -      | -            | -             |

**Table 175: USB Detection Type**

| Binary Value | ASCII Value | Description               |
|--------------|-------------|---------------------------|
| 0            | NONE        | Nothing is detected       |
| 1            | USBSTICK    | A flash drive is detected |
| 2            | PC          | A computer is detected    |
| 3            | ERROR       | This is an error state    |

**Table 176: USB Mode**

| <b>Binary Value</b> | <b>ASCII Value</b> | <b>Description</b>                           |
|---------------------|--------------------|--|
| 0                   | DEVICE             | The USB port is in device mode               |
| 1                   | HOST               | The USB port is in host mode                 |
| 2                   | OTG                | The USB port is in OTG mode                  |
| 3                   | INVALID            | The USB port is in an invalid mode           |
| 4                   | NONE               | The USB port is not in a operation mode      |
| 5                   | TRANSITION         | The USB port operation mode is transitioning |

## 3.181 UPTIME

### *Report the running time of the receiver*

**Platform:** OEM719, OEM729, OEM7500, OEM7700, OEM7720, PwrPak7, HxGN PIM7500

This log reports the number of seconds the receiver's firmware has been running, after the application of power or after the completion of a reset.

**Message ID:** 1777

**Log Type:** Polled

**Recommended Input:**

```
log uptime once
```

**ASCII Example:**

```
#UPTIMEA,COM1,0,80.0,FINESTEERING,1928,495123.000,02000020,27d2,32768;
151639*013e11a7
```



151639 seconds since power-on = 42.1 hours.

| Field | Field Type    | Description  | Format | Binary Bytes | Binary Offset |
|-------|---------------|--|--------|--------------|---------------|
| 1     | UPTIME header | Log header. See <i>Messages</i> on page 25 for more information.               | -      | H            | 0             |
| 2     | Uptime        | The number of seconds the receiver has been running after a power up or reset. | Ulong  | 4            | H             |
| 3     | xxxx          | 32-bit CRC (ASCII and Binary only)   | Hex    | 4            | H+4           |
| 4     | [CR][LF]      | Sentence terminator (ASCII only)   | -      | -            | -             |

## 3.182 VALIDMODELS

### *Valid model information*

**Platform: OEM719, OEM729, OEM7500, OEM7700, OEM7720, PwrPak7, HxGN PIM7500**

This log gives a list of valid authorized models available and expiry date information.

If a model has no expiry date, it reports the year, month and day fields as 0, 0 and 0 respectively.

**Message ID: 206**

**Log Type: Asynch**

**Recommended Input:**

```
log validmodelsa once
```

**ASCII Example:**

```
#VALIDMODELSA,COM1,0,92.0,FINESTEERING,1610,499139.682,02000000,342f,6293;1,"D2LR0RCCR",0,0,0*d0580c1b
```



Use the VALIDMODELS log to output a list of available models for the receiver. Use the **AUTH** command (see page 74), to add a model and the **MODEL** command (see page 232) to change the currently active model. See the **VERSION** log on page 836 for the currently active model

| Field | Field type         | Description  | Format         | Binary Bytes | Binary Offset      |
|-------|--------------------|--|----------------|--------------|--------------------|
| 1     | VALIDMODELS header | Log header. See <i>Messages</i> on page 25 for more information. |                | H            | 0                  |
| 2     | #mod               | Number of models with information to follow                      | Ulong          | 4            | H                  |
| 3     | model              | Model name   | String [Max16] | Variable 1   | H+4                |
| 4     | expyear            | Expiry year  | Ulong          | 4            | Variable Max:H+20  |
| 5     | expmonth           | Expiry month   | Ulong          | 4            | Variable Max: H+24 |

<sup>1</sup>In the binary case, each string field needs to be NULL terminated and additional bytes of padding added to maintain 4-byte alignment, up to the maximum defined by the string size. The next defined field starts immediately at the next 4-byte alignment following the NULL.

| Field | Field type   | Description                        | Format | Binary Bytes | Binary Offset                            |
|-------|--|------------------------------------|--------|--------------|--|
| 6     | expday   | Expiry day                         | Ulong  | 4            | Variable:<br>Max: H+28                   |
| 7...  | Next model offset = H+4+(#mod x variable [max:28]) |                                    |        |              |  |
| 8     | xxxx   | 32-bit CRC (ASCII and Binary only) | Ulong  | 4            | H+4+<br>(#mod x<br>variable<br>[max:28]) |
| 9     | [CR][LF]   | Sentence terminator (ASCII only)   | -      | -            | -  |



### 3.183 VERIPOSINFO

#### *Veripos subscription information*

**Platform: OEM719, OEM729, OEM7500, OEM7700, OEM7720, PwrPak7, HxGN PIM7500**

This log contains details on the Veripos subscription.

**Message ID: 1728**

**Log Type: Asynch**

**Recommended Input:**

```
log veriposinfoa onchanged
```

**ASCII Example:**

```
#VERIPOSINFOA,COM2,0,60.5,FINESTEERING,1779,176287.725,02044008,31fa,12740;320325,NCC_CONTROLLED,00000101,"Q"*26a9f04e
```

| Field | Field type         | Description  | Format  | Binary Bytes | Binary Offset |
|-------|--------------------|--|---------|--------------|---------------|
| 1     | VERIPOSINFO header | Log header. See <i>Messages</i> on page 25 for more information.                                     |         | H            | 0             |
| 2     | Serial number      | Receiver serial number   | Ulong   | 4            | H             |
| 3     | Mode               | Operating mode (see <i>Table 177: Veripos Operating Mode</i> below)                                  | Enum    | 4            | H+4           |
| 4     | Details            | Subscription details (refer to <i>Table 178: Veripos Subscription Details Mask</i> on the next page) | Hex     | 4            | H+8           |
| 5     | Service code       | Veripos service code   | Char[4] | 4            | H+12          |
| 6     | xxxx               | 32-bit CRC (ASCII and Binary only)   | Ulong   | 4            | H+16          |
| 7     | [CR][LF]           | Sentence terminator (ASCII only)   | -       | -            | -             |

**Table 177: Veripos Operating Mode**

| ASCII          | Binary | Description   |
|----------------|--------|---|
| UNASSIGNED     | 0      | Decoder has not had an assigned operating mode                                |
| NCC_CONTROLLED | 7      | Decoder operation disabled by a command from the Network Control Center (NCC) |
| NO_DISABLE     | 8      | Decoder operation not disabled  |

---

| ASCII        | Binary | Description  |
|--------------|--------|--|
| BUBBLE       | 100    | Decoder is operating in a Veripos permitted subscription-free bubble |
| MODEL_DENIED | 101    | Decoder operation is not permitted on the current firmware model     |

**Table 178: Veripos Subscription Details Mask**

| Bit | Mask  | Description                                   |
|-----|-------|---|
| 0   | 0x001 | Subscription permits differential positioning |
| 8   | 0x100 | Subscription permits Apex PPP positioning     |

## 3.184 VERIPOSSTATUS

### *Veripos decoder and subscription status*

**Platform:** OEM719, OEM729, OEM7500, OEM7700, OEM7720, PwrPak7, HxGN PIM7500

This log contains status information for the Veripos decoder and subscription.

**Message ID:** 1730

**Log Type:** Asynch

**Recommended Input:**

```
log veriposstatusa onchanged
```

**ASCII Example:**

```
#VERIPOSSTATUSA,COM2,0,62.0,FINESTEERING,1779,176955.656,02004008,0719,12740;ENABLE,LOCKED*7c5f85ae
```

| Field | Field type           | Description   | Format | Binary Bytes | Binary Offset |
|-------|----------------------|---|--------|--------------|---------------|
| 1     | VERIPOSSTATUS header | Log header. See <i>Messages</i> on page 25 for more information.                                    |        | H            | 0             |
| 2     | Access               | Access status. ENABLE (1) if the subscription is valid; DISABLE (0) otherwise                       | Enum   | 4            | H             |
| 3     | Sync state           | Decoder data synchronization state (see <i>Table 179: Decoder Data Synchronization State</i> below) | Enum   | 4            | H+4           |
| 4     | xxxx                 | 32-bit CRC (ASCII and Binary only)  | Ulong  | 4            | H+8           |
| 5     | [CR][LF]             | Sentence terminator (ASCII only)  | -      | -            | -             |

**Table 179: Decoder Data Synchronization State**

| ASCII     | Binary | Description  |
|-----------|--------|--|
| NO_SIGNAL | 0      | None of the decoders have received data in the last 30 seconds         |
| SEARCH    | 1      | At least one decoder is receiving data and is searching for the format |
| LOCKED    | 2      | At least one decoder has locked onto the format                        |

## 3.185 VERSION

### *Version information*

**Platform: OEM719, OEM729, OEM7500, OEM7700, OEM7720, PwrPak7, HxGN PIM7500**

This log contains the version information for all components of a system. When using a standard receiver, there is only one component in the log.

A component may be hardware (for example, a receiver or data collector) or firmware in the form of applications or data (for example, data blocks for height models or user applications). See *Table 181: VERSION Log Field Formats* on page 838 for details on the format of key fields.

See also the **VALIDMODELS** log on page 831.

**Message ID: 37**

**Log Type: Polled**

**Recommended Input:**

log versiona once

**ASCII Example:**

```
[COM1]<VERSION COM1 0 97.0 UNKNOWN 0 200.384 024c0009 3681 13662
< 2
< GPSCARD "CFNPNTVN" "BMGX15360001Z" "OEM729-0.00H"
"OM7MR0000RN0000" "OM7BR0000AB0001" "2015/Dec/14" "19:23:28"
< OEM7FPGA "" "" "" "OMV070000DN0008" "" "" ""
```



The VERSION log is a useful log as a first communication with your receiver. Once connected, using NovAtel Connect or HyperTerminal, log VERSION and check that the output makes sense. Also, ensure that you have the receiver components you expected.

| Field | Field type     | Description   | Format    | Binary Bytes | Binary Offset |
|-------|----------------|---|-----------|--------------|---------------|
| 1     | VERSION header | Log header. See <i>Messages</i> on page 25 for more information.                                |           | H            | 0             |
| 2     | # comp         | Number of components (cards, and so on)   | Long      | 4            | H             |
| 3     | type           | Component type (see <i>Table 180: Component Types</i> on the next page)                         | Enum      | 4            | H+4           |
| 4     | model          | OEM7 firmware model number e.g., G1SBOGTTO indicates the receiver's current model functionality | Char [16] | 16           | H+8           |

| Field | Field type                                    | Description   | Format    | Binary Bytes | Binary Offset      |
|-------|---|---|-----------|--------------|--------------------|
| 5     | psn   | Product serial number   | Char [16] | 16           | H+24               |
| 6     | hw version                                    | Hardware version, see <i>Table 181: VERSION Log Field Formats</i> on the next page          | Char [16] | 16           | H+40               |
| 7     | sw version                                    | Firmware software version, see <i>Table 181: VERSION Log Field Formats</i> on the next page | Char [16] | 16           | H+56               |
| 8     | boot version                                  | Boot code version, see <i>Table 181: VERSION Log Field Formats</i> on the next page         | Char [16] | 16           | H+72               |
| 9     | comp date                                     | Firmware compile date, see <i>Table 181: VERSION Log Field Formats</i> on the next page     | Char [12] | 12           | H+88               |
| 10    | comp time                                     | Firmware compile time, see <i>Table 181: VERSION Log Field Formats</i> on the next page     | Char [12] | 12           | H+100              |
| 11... | Next component offset = H + 4 + (#comp x 108) |   |           |              |                    |
| 12    | xxxx  | 32-bit CRC (ASCII and Binary only)  | Ulong     | 4            | H+4+ (#comp x 108) |
| 13    | [CR][LF]                                      | Sentence terminator (ASCII only)  | -         | -            | -                  |

**Table 180: Component Types**

| Binary                 | ASCII          | Description                      |
|------------------------|----------------|----------------------------------|
| 0                      | UNKNOWN        | Unknown component                |
| 1                      | GPSCARD        | OEM7 family component            |
| 2                      | CONTROLLER     | Reserved                         |
| 3                      | ENCLOSURE      | OEM card enclosure               |
| 4-7                    | Reserved       |                                  |
| 8                      | USERINFO       | Application specific information |
| 12-18                  | Reserved       |                                  |
| 19                     | WWW_CONTENT    | Web Server content               |
| 20                     | Reserved       |                                  |
| 21                     | OEM7FPGA       | OEM7 FPGA version                |
| 27                     | EMBEDDED_AUTH  | Embedded Auth Code data          |
| 981073920 (0x3A7A0000) | DB_HEIGHTMODEL | Height/track model data          |
| 981073930 (0x3A7A000A) | DB_LUA_SCRIPTS | Lua Script ISO Image             |

**Table 181: VERSION Log Field Formats**

| <b>Field Type</b> | <b>Field Format (ASCII)</b> | <b>Description</b>   |
|-------------------|-----------------------------|--|
| hw version        | P-R                         | Hardware version:<br>P = hardware platform (for example, OEM719)<br>R = hardware revision (for example, 00)  |
| sw version        | OM7MRFFMMRN0000             | Software Version:<br>OM7 = product family<br>M = image type (main firmware)<br>R = Signature and symbols<br>FF = feature release number<br>MM = maintenance release number<br>RN = Firmware version and distribution permits<br>0000 = Minor release indicator |
| boot version      | OM7BRFFMMRN0000             | Boot Version:<br>OM7 = product family<br>B = image type (boot)<br>R = Signature and symbols<br>FF = feature release<br>MM = the maintenance release number<br>RN = Signature and symbols   |
| comp date         | YYYY/Mmm/DD                 | YYYY = year<br>Mmm = month<br>DD = day (1 - 31)  |
| comp time         | HH:MM:SS                    | HH = hour<br>MM = minutes<br>SS = seconds  |

## 3.186 WIFIAPSETTINGS

### *Display the Wi-Fi access point configuration*

#### Platform: PwrPak7

Use this log to display the Wi-Fi access point configuration. If the access point is not currently operational, the log reports the access point configuration to be applied the next time the **WIFIMODE AP** command is received.

#### Message ID: 2093

#### Log Type: Polled

#### Recommended input:

```
LOG WIFIAPSETTINGS
```

#### ASCII Example:

```
#WIFIAPSETTINGS,COM1,0,83.5,FINESTEERING,1967,237987.000,02040020,217
a,32768;"PwrPak7-
NMND17190003B", "QUN7WVSH", 2P4GHZ, WPA2, CCMP, US, 11, "00:21:66:01:47:b4", 0
*e5831d54
```

| Field | Field Type            | Description  | Format          | Binary Bytes | Binary Offset |
|-------|-----------------------|--|-----------------|--------------|---------------|
| 1     | WIFIAPSETTINGS header | Log header. See <i>Messages</i> on page 25 for more information.             | -               | H            | 0             |
| 2     | ssid                  | SSID of the AP   | String [Max 33] | Variable     | H             |
| 3     | passkey               | Passkey of the AP  | String [Max 65] | Variable     | Variable      |
| 4     | band                  | 2.4GHz   | Enum            | 4            | Variable      |
| 5     | security protocol     | WPA2_PSK   | Enum            | 4            | Variable      |
| 6     | encryption            | AES_CCMP   | Enum            | 4            | Variable      |
| 7     | region                | Regulatory region  | Enum            | 4            | Variable      |
| 8     | channel               | Wireless channel used by access point to communicate with connected clients. | Int             | 4            | Variable      |
| 9     | bssid                 | BSSID of the AP (MAC of the Wi-Fi interface)                                 | String [Max 18] | Variable     | Variable      |

| <b>Field</b> | <b>Field Type</b> | <b>Description</b>                | <b>Format</b> | <b>Binary Bytes</b> | <b>Binary Offset</b> |
|--------------|-------------------|-----------------------------------|---------------|---------------------|----------------------|
| 10           | xxxx              | 32-bit CRC (ASCII or Binary only) | Hex           | 4                   | Variable             |
| 11           | [CR][LF]          | Sentence terminator (ASCII only)  | -             | -                   | -                    |



## Chapter 4 SPAN Commands

The commands used to configure GNSS+INS functions are described in the following sections. For information about other available commands, refer to *Core Commands* on page 52.

## 4.1 ALIGNMENTMODE

### *Set the Alignment Mode*

**Platform:** OEM719, OEM729, OEM7500, OEM7700, OEM7720, PwrPak7, HxGN PIM7500

Use this command to set the alignment method used to initialize the SPAN system.

The default ALIGNMENTMODE is AUTOMATIC. In this mode, the first available method to align is used.

Sending the ALIGNMENTMODE command manually overrides the AUTOMATIC setting and changes the options available to complete an alignment.

**Message ID:** 1214

#### **Abbreviated ASCII Syntax:**

```
ALIGNMENTMODE mode
```

#### **Abbreviated ASCII Example:**

```
ALIGNMENTMODE AIDED_TRANSFER
```

| Field | Field Type           | ASCII Value | Binary Value | Description  | Binary Format | Binary Bytes | Binary Offset |
|-------|----------------------|-------------|--------------|--|---------------|--------------|---------------|
| 1     | ALIGNMENTMODE header | -           | -            | Command header. See <i>Messages</i> on page 25 for more information. | -             | H            | 0             |

| Field | Field Type | ASCII Value    | Binary Value | Description  | Binary Format | Binary Bytes | Binary Offset |
|-------|------------|----------------|--------------|--|---------------|--------------|---------------|
| 2     | mode       | UNAIDED        | 0            | Static coarse alignment or kinematic alignment methods are available.  | Enum          | 4            | H             |
|       |            | AIDED_STATIC   | 1            | Seed the static coarse alignment with an initial azimuth from the ALIGN solution.  |               |              |               |
|       |            | AIDED_TRANSFER | 2            | Seed the full attitude from an ALIGN solution.   |               |              |               |
|       |            | AUTOMATIC      | 3            | Seed the full attitude from the ALIGN solution, perform a regular static coarse alignment or perform a kinematic alignment, whichever is possible first. |               |              |               |
|       |            | STATIC         | 4            | Static coarse alignment method only.   |               |              |               |
|       |            | KINEMATIC      | 5            | Kinematic alignment method only.   |               |              |               |



If the **ALIGNMENTMODE** selected can use a kinematic alignment (UNAIDED, KINEMATIC or AUTOMATIC), the **SETINSROTATION** command on page 877 must be sent to the receiver regardless of system configuration and IMU orientation.



NVM Seed injected (see the **INSSEED** command on page 861) and commanded (see **SETINITAZIMUTH** command on page 874) alignments are valid for all alignment modes and will supersede all other options if valid and available.

## 4.2 ASYNCHINSLOGGING

### *Enable Asynchronous INS Logs*

**Platform:** OEM719, OEM729, OEM7500, OEM7700, OEM7720, PwrPak7, HxGN PIM7500

Use this command to enable or disable the asynchronous INS logs (IMURATECORRIMUS and IMURATEPVAS).



The asynchronous INS logs are highly advanced logs for users of SPAN on OEM7. The rate controls that limit the output of logs are not applicable to these logs, allowing the user to drive the idle time to zero.

Users of the **IMURATECORRIMUS** log (see page 909) or **IMURATEPVAS** log (see page 913) should be limited to those who must have full rate INS solution data, or full rate corrected IMU data, without possible shifts in log time that are present in the synchronous version of these logs.

The asynchronous INS logs are only available at the full rate of the IMU.

**Message ID:** 1363

#### **Abbreviated ASCII Syntax:**

```
ASYNCHINSLOGGING switch
```

#### **Abbreviated ASCII Example:**

```
ASYNCHINSLOGGING ENABLE
```

| Field | Field Type               | ASCII Value | Binary Value | Description  | Binary Format | Binary Bytes | Binary Offset |
|-------|--------------------------|-------------|--------------|--|---------------|--------------|---------------|
| 1     | ASYNCHINS LOGGING header | -           | -            | Command header. See <i>Messages</i> on page 25 for more information. | -             | H            | 0             |
| 2     | Switch                   | DISABLE     | 0            | Enable or disable the asynchronous INS logs.                         | Enum          | 4            | H             |
|       |                          | ENABLE      | 1            | The default value is DISABLE.  |               |              |               |

## 4.3 CONNECTIMU

### *Connects an IMU to a Port*

**Platform:** OEM719, OEM729, OEM7500, OEM7700, OEM7720, PwrPak7, HxGN PIM7500

Use this command to specify the type of IMU connected to the receiver and the receiver port used by the IMU.

**Message ID:** 1428

**Abbreviated ASCII Syntax:**

```
CONNECTIMU IMUPort IMUType
```

**Abbreviated ASCII Example:**

```
CONNECTIMU COM2 LN200
```

| Field | Field Type           | ASCII Value                                     | Binary Value | Description  | Binary Format | Binary Bytes | Binary Offset |
|-------|----------------------|---|--------------|--|---------------|--------------|---------------|
| 1     | CONNECTIMU header    | -   | -            | Command header. See <i>Messages</i> on page 25 for more information. | -             | H            | 0             |
| 2     | IMUPort <sup>1</sup> | COM1  | 1            | IMU Port is COM port 1   | Enum          | 4            | H             |
|       |                      | COM2  | 2            | IMU Port is COM port 2   |               |              |               |
|       |                      | COM3  | 3            | IMU Port is COM port 3   |               |              |               |
|       |                      | SPI   | 7            | IMU Port is the SPI port   |               |              |               |
|       |                      | COM4  | 19           | IMU Port is COM port 4   |               |              |               |
|       |                      | COM5  | 31           | IMU Port is COM port 5   |               |              |               |
| 3     | IMUType              | See <i>Table 182: IMU Type</i> on the next page |              | IMU Type   | Enum          | 4            | H+4           |



SPI is available only on the OEM7500, OEM7700, OEM7720 and HxGN PIM7500.



COM4 and COM5 are available only on the OEM7700 and OEM7720.

<sup>1</sup>The IMU-ISA-100C, IMU-FSAS, IMU-HG1900, IMU-LN200, IMU- $\mu$ IMU, IMU-CPT and IMU-KVH1750 use RS-422 protocol and must be connected to a receiver port that is configured to use RS-422. Refer to the [OEM7 Installation and Operation User Manual](#) for information about which receiver ports support RS-422 and instructions for enabling RS-422.

**Table 182: IMU Type**

| Binary | ASCII          | Description                         |
|--------|----------------|-------------------------------------|
| 0      | UNKNOWN        | Unknown IMU type (default)          |
| 1      | HG1700_AG11    | Honeywell HG1700 AG11               |
| 4      | HG1700_AG17    | Honeywell HG1700 AG17               |
| 5      | HG1900_CA29    | Honeywell HG1900 CA29               |
| 8      | LN200          | Northrop Grumman LN200/LN200C       |
| 11     | HG1700_AG58    | Honeywell HG1700 AG58               |
| 12     | HG1700_AG62    | Honeywell HG1700 AG62               |
| 13     | IMAR_FSAS      | iMAR iIMU-FSAS                      |
| 16     | KVH_COTS       | KVH CPT IMU                         |
| 20     | HG1930_AA99    | Honeywell HG1930 AA99               |
| 26     | ISA100C        | Northrop Grumman Litef ISA-100C     |
| 27     | HG1900_CA50    | Honeywell HG1900 CA50               |
| 28     | HG1930_CA50    | Honeywell HG1930 CA50               |
| 31     | ADIS16488      | Analog Devices ADIS16488            |
| 32     | STIM300        | Sensoror STIM300                    |
| 33     | KVH_1750       | KVH1750 IMU                         |
| 41     | EPSON_G320     | Epson G320N                         |
| 52     | LITEF_MICROIMU | Northrop Grumman Litef $\mu$ IMU-IC |
| 56     | STIM300D       | Sensoror STIM300, Direct Connection |



The IMU Type field also supports the legacy ASCII values that contain the "IMU\_" prefix. For example, *LN200* or *IMU\_LN200*. IMUs recently added as SPAN supported devices, such as the LITEF\_MICROIMU and STIM300D, do not support the "IMU\_" prefix.



Values not shown in this table are reserved.

## 4.4 EXTERNALPVAS

### *Enter PVA Update*

**Platform: OEM719, OEM729, OEM7500, OEM7700, OEM7720, PwrPak7, HxGN PIM7500**



This command should only be used by advanced users of GNSS/INS.



The standard deviations entered using this command must be representative of actual input error.



The **EXTERNALPVAS** command uses a short header if the command is entered in ASCII or Binary.

This command allows a user to provide full position, velocity and attitude updates, in any combination, to the INS. The user can also provide height or attitude only updates, along with Zero Velocity Updates (ZUPTs). These position and velocity updates are entered in local level frame or ECEF.



The default input frame is ECEF. Updates are entered in ECEF unless Local Level is specified using the OptionsMask parameter.

**Message ID: 1463**

#### **Abbreviated ASCII Syntax:**

```
EXTERNALPVAS Position1 Position2 Position3 Velocity1 Velocity2 Velocity3
Attitude1 Attitude2 Attitude3 PosStdDev1 PosStdDev2 PosStdDev3 VelStdDev1
VelStdDev2 VelStdDev3 AttStdDev1 AttStdDev2 AttStdDev3 UpdateMask
OptionsMask
```

#### **Abbreviated ASCII Example:**

```
EXTERNALPVAS 51.13495816 -114.03232307 1064.5895 -10.4502 0.2485 -0.09598
1.3152366 -3.6474718 179.5885212 0.01 0.01 0.01 0.01 0.01 0.01 0.1 0.1 0.1
C020 1
```

| Field | Field Type          | ASCII Value | Binary Value | Description  | Binary Format | Binary Bytes | Binary Offset |
|-------|---------------------|-------------|--------------|--|---------------|--------------|---------------|
| 1     | EXTERNALPVAS header | -           | -            | Command header. See <i>Messages</i> on page 25 for more information. | -             | H            | 0             |

| Field | Field Type | ASCII Value | Binary Value | Description  | Binary Format | Binary Bytes | Binary Offset |
|-------|------------|-------------|--------------|--|---------------|--------------|---------------|
| 2     | Position1  |             |              | Latitude in degrees or ECEF X-coordinate in metres           | Double        | 8            | H             |
| 3     | Position2  |             |              | Longitude in degrees or ECEF Y-coordinate in metres          | Double        | 8            | H+8           |
| 4     | Position3  |             |              | Height or ECEF Z-coordinate in metres                        | Double        | 8            | H+16          |
| 5     | Velocity1  |             |              | North velocity or velocity along the X-axis in metres/second | Float         | 4            | H+24          |
| 6     | Velocity2  |             |              | East velocity or velocity along the Y-axis in metres/second  | Float         | 4            | H+28          |
| 7     | Velocity3  |             |              | Up velocity or velocity along the Z-axis in metres/second    | Float         | 4            | H+32          |
| 8     | Attitude1  |             |              | Pitch in local level in degrees                              | Float         | 4            | H+36          |
| 9     | Attitude2  |             |              | Roll in local level in degrees                               | Float         | 4            | H+40          |
| 10    | Attitude3  |             |              | Azimuth in local level in degrees                            | Float         | 4            | H+44          |
| 11    | PosStdDev1 |             |              | Position1 standard deviation in metres                       | Float         | 4            | H+48          |
| 12    | PosStdDev2 |             |              | Position2 standard deviation in metres                       | Float         | 4            | H+52          |
| 13    | PosStdDev3 |             |              | Position3 standard deviation in metres                       | Float         | 4            | H+56          |
| 14    | VelStdDev1 |             |              | Velocity1 standard deviation in metres/second                | Float         | 4            | H+60          |
| 15    | VelStdDev2 |             |              | Velocity2 standard deviation in metres/second                | Float         | 4            | H+64          |



| Field | Field Type  | ASCII Value | Binary Value | Description  | Binary Format | Binary Bytes | Binary Offset |
|-------|-------------|-------------|--------------|--|---------------|--------------|---------------|
| 16    | VelStdDev3  |             |              | Velocity3 standard deviation in metres/second  | Float         | 4            | H+68          |
| 17    | AttStdDev1  |             |              | Attitude1 standard deviation in degrees  | Float         | 4            | H+72          |
| 18    | AttStdDev2  |             |              | Attitude2 standard deviation in degrees  | Float         | 4            | H+76          |
| 19    | AttStdDev3  |             |              | Attitude3 standard deviation in degrees  | Float         | 4            | H+80          |
| 20    | UpdateMask  |             |              | This mask selects which updates are applied. Setting a bit applies the update and more than one update can be applied at one time.<br><br><i>See Table 183: EXTERNALPVAS Updates Mask below.</i> | HEX Ulong     | 4            | H+84          |
| 21    | OptionsMask |             |              | This mask selects the update options. See <i>Table 184: EXTERNALPVAS Options Mask</i> on the next page.  | HEX Ulong     | 4            | H+88          |

**Table 183: EXTERNALPVAS Updates Mask**

| Bit | Mask    | Description   |
|-----|---------|---|
| 0   | 0x00001 | Reserved  |
| 1   | 0x00002 | Reserved  |
| 2   | 0x00004 | ZUPT Update. No fields required in the <b>EXTERNALPVAS</b> command for this update.                               |
| 3   | 0x00008 | Reserved  |
| 4   | 0x00010 | Reserved  |
| 5   | 0x00020 | External Position Update. This update is entered using Position1 to Position3 in the <b>EXTERNALPVAS</b> command. |

| Bit | Mask    | Description  |
|-----|---------|--|
| 6   | 0x00040 | Reserved   |
| 7   | 0x00080 | Reserved   |
| 8   | 0x00100 | Reserved   |
| 9   | 0x00200 | Reserved   |
| 10  | 0x00400 | Reserved   |
| 11  | 0x00800 | Reserved   |
| 12  | 0x01000 | Reserved   |
| 13  | 0x02000 | Reserved   |
| 14  | 0x04000 | External Velocity Update.<br>This update is entered using Velocity1 to Velocity3 in the <b>EXTERNALPVAS</b> command. |
| 15  | 0x08000 | External Attitude Update.<br>This update is entered using Attitude1 to Attitude3 in the <b>EXTERNALPVAS</b> command. |
| 16  | 0x10000 | External Heading Update.<br>This update is entered using Attitude3 in the <b>EXTERNALPVAS</b> command.               |
| 17  | 0x20000 | External Height Update.<br>This update is entered using Position3 in the <b>EXTERNALPVAS</b> command.                |



If both the External Position Update and External Height Update bits are set, only the External Position Update will be applied.

If both the External Attitude Update and External Heading Update bits are set, only the External Attitude Update will be applied.

**Table 184: EXTERNALPVAS Options Mask**

| Bit | Mask | Description  |
|-----|------|--|
| 0   | 0x1  | If this bit is set, the position and velocity input frame is set to local level.<br>If cleared, the input frame is ECEF. |
| 1   | 0x2  | If this bit is set, the heading update is set relative.<br>If cleared, the heading update is absolute.                   |

## 4.5 HEAVEFILTER

### *Enables or Disables Heave Filtering*

**Platform: OEM719, OEM729, OEM7500, OEM7700, OEM7720, PwrPak7, HxGN PIM7500**

Use this command to enable or disable the filter used for heave processing.



To configure the length of the heave filter, use the **SETHEAVEWINDOW** command (see page 870).

**Message ID: 1427**

**Abbreviated ASCII Syntax:**

```
HEAVEFILTER switch
```

**Abbreviated ASCII Example:**

```
HEAVEFILTER ENABLE
```

| Field | Field Type         | ASCII Value | Binary Value | Description  | Binary Format | Binary Bytes | Binary Offset |
|-------|--------------------|-------------|--------------|--|---------------|--------------|---------------|
| 1     | HEAVEFILTER header | -           | -            | Command header. See <i>Messages</i> on page 25 for more information. | -             | H            | 0             |
| 2     | switch             | DISABLE     | 0            | Disables the Heave filter.   | Enum          | 4            | H             |
|       |                    | ENABLE      | 1            | Enables the Heave filter.  |               |              |               |

## 4.6 INPUTGIMBALANGLE

### *Input Gimbal Angles into the Receiver*

**Platform: OEM719, OEM729, OEM7500, OEM7700, OEM7720, PwrPak7, HxGN PIM7500**

Use this command to input information about the current mount gimbal angles. Gimbal angles are the angle from the locked mount frame to the current gimbal location. They are input in the mount body frame. See [OEM7 SPAN Installation and Operation User Manual](#) for details on frame definitions.



It is very important to follow the order of rotations (Z, X, Y) when determining the rotations from the locked mount frame to the current gimbal location.

**Message ID: 1317**

#### Abbreviated ASCII Syntax:

```
INPUTGIMBALANGLE XAngle YAngle ZAngle [XUncert] [YUncert] [ZUncert]
```

#### Abbreviated ASCII Examples:

```
INPUTGIMBALANGLE 0.003 -0.1234 12.837
```

```
INPUTGIMBALANGLE 0.003 -0.1234 12.837 0.001 0.001 0.005
```

| Field | Field Type              | ASCII Value | Binary Value | Description  | Binary Format | Binary Bytes | Binary Offset |
|-------|-------------------------|-------------|--------------|--|---------------|--------------|---------------|
| 1     | INPUTGIMBALANGLE header | -           | -            | Command header. See <i>Messages</i> on page 25 for more information.                                 | -             | H            | 0             |
| 2     | X Angle                 | ±180        |              | Right hand rotation from the locked mount frame X axis to the current gimbal location in degrees.    | Double        | 8            | H             |
| 3     | Y Angle                 | ±180        |              | Right hand rotation from the locked mount frame Y axis to the current gimbal location in degrees.    | Double        | 8            | H+8           |
| 4     | Z Angle                 | ±180        |              | Right hand rotation from the locked mount frame Z axis to the current gimbal location to in degrees. | Double        | 8            | H+16          |

| <b>Field</b> | <b>Field Type</b> | <b>ASCII Value</b> | <b>Binary Value</b> | <b>Description</b>                                    | <b>Binary Format</b> | <b>Binary Bytes</b> | <b>Binary Offset</b> |
|--------------|-------------------|--------------------|---------------------|---|----------------------|---------------------|----------------------|
| 4            | X Uncertainty     | 0 – 180            |                     | Uncertainty of X rotation in degrees.<br>Default is 0 | Double               | 8                   | H+24                 |
| 5            | Y Uncertainty     | 0 – 180            |                     | Uncertainty of Y rotation in degrees.<br>Default is 0 | Double               | 8                   | H+32                 |
| 6            | Z Uncertainty     | 0 – 180            |                     | Uncertainty of Z rotation in degrees.<br>Default is 0 | Double               | 8                   | H+40                 |

## 4.7 INSALIGNCONFIG

### Configure ALIGN Parameters for SPAN Receiver

**Platform: OEM719, OEM729, OEM7500, OEM7700, OEM7720, PwrPak7, HxGN PIM7500**

When the SPAN system is configured for dual antenna, it automatically attempts to connect to an ALIGN capable rover to establish dual antenna corrections. It also attempts to re-establish these corrections should they stop.

Use the **INSALIGNCONFIG** command to configure ALIGN for a SPAN master receiver to a secondary rover receiver.



#### Important

- By default, the receiver is configured to use COM2 for both the master and rover receivers for ALIGN communication.
- When using ICOM ports, the Ethernet settings on the SPAN master and rover receiver must be manually configured.
- The master and rover ports must be the same interface type (i.e. Serial to Serial or Ethernet to Ethernet).
- The **INSALIGNCONFIG** command can be used to set the output rate for dual antenna receivers (e.g. OEM7720). In these cases, the port configuration fields are ignored.

**Message ID: 2163**

#### Abbreviated ASCII Syntax:

```
INSALIGNCONFIG masterport [roverport] [baudrate] [outputrate]
```

#### Abbreviated ASCII Example:

```
INSALIGNCONFIG COM1 COM2 230400 5
```

| Field | Field Type            | ASCII Value | Binary Value | Description  | Format | Binary Bytes | Binary Offset |
|-------|-----------------------|-------------|--------------|--|--------|--------------|---------------|
| 1     | INSALIGNCONFIG header | -           | -            | Command header. See <i>Messages</i> on page 25 for more information. | -      | H            | 0             |

| Field | Field Type | ASCII Value                      | Binary Value | Description   | Format | Binary Bytes | Binary Offset |
|-------|------------|----------------------------------|--------------|---|--------|--------------|---------------|
| 2     | masterport | NOPORT                           | 0            | Specify which COM port on the master receiver to use to communicate with an external ALIGN capable receiver.<br><br>Selecting NOPORT disables automatic dual antenna configuration. | Enum   | 4            | H             |
|       |            | COM1                             | 1            |   |        |              |               |
|       |            | COM2                             | 2            |   |        |              |               |
|       |            | COM3                             | 3            |   |        |              |               |
|       |            | COM4                             | 19           |   |        |              |               |
|       |            | COM5                             | 31           |   |        |              |               |
|       |            | ICOM1                            | 23           |   |        |              |               |
|       |            | ICOM2                            | 24           |   |        |              |               |
|       |            | ICOM3                            | 25           |   |        |              |               |
|       |            | ICOM4                            | 29           |   |        |              |               |
|       |            | ICOM5                            | 46           |   |        |              |               |
|       |            | ICOM6                            | 47           |   |        |              |               |
| ICOM7 | 48         |                                  |              |   |        |              |               |
| 3     | roverport  | COM1                             | 1            | Specify which rover COM port is connected to the master receiver<br><br>(Default = COM2)  | Enum   | 4            | H+4           |
|       |            | COM2                             | 2            |   |        |              |               |
|       |            | COM3                             | 3            |   |        |              |               |
|       |            | COM4                             | 19           |   |        |              |               |
|       |            | COM5                             | 31           |   |        |              |               |
|       |            | ICOM1                            | 23           |   |        |              |               |
|       |            | ICOM2                            | 24           |   |        |              |               |
|       |            | ICOM3                            | 25           |   |        |              |               |
|       |            | ICOM4                            | 29           |   |        |              |               |
|       |            | ICOM5                            | 46           |   |        |              |               |
|       |            | ICOM6                            | 47           |   |        |              |               |
|       |            | ICOM7                            | 48           |   |        |              |               |
| 4     | baudrate   | 57600, 115200, 230400, or 460800 |              | Baud rate for communication<br><br>(Default = 230400)   | Ulong  | 4            | H+8           |

| Field | Field Type | ASCII Value    | Binary Value | Description   | Format | Binary Bytes | Binary Offset |
|-------|------------|----------------|--------------|---|--------|--------------|---------------|
| 5     | outputrate | 1, 2, 4, 5, 10 |              | The data rate, in Hz, in which ALIGN will be output<br>(Default = 1 Hz) | Ulong  | 4            | H+12          |
| 6     | Reserved   | -              |              | Reserved  | Ulong  | 4            | H+16          |



The SPAN filter only requires ALIGN updates at 1 Hz. Increasing the output rate (using the *outputrate* field) does not increase performance, it only provides ALIGN logs at higher rates.



## 4.8 INSCALIBRATE

### *Initiate calibration of the INS offsets*

**Platform: OEM719, OEM729, OEM7500, OEM7700, OEM7720, PwrPak7, HxGN PIM7500**

Use this command to initiate the calibration of INS offsets.



The RBV calibration requires a valid RBV estimate to be entered prior to initializing the calibration. See the **SETINSROTATION** command on page 877 for details on entering a RBV estimate.



For optimal SPAN performance when using Dual Antenna with SPAN an ALIGN offset calibration is required for each unique installation. This calibration refines the IMU to antenna baseline angular offset from the initial estimate derived from the input lever arms.

**Message ID: 1882**

#### **Abbreviated ASCII Syntax:**

```
INSCALIBRATE Offset [Trigger] [SDThreshold]
```

#### **Abbreviated ASCII Example:**

```
INSCALIBRATE RBV NEW 1.0
```

| Field | Field Type          | ASCII Value | Binary Value | Description  | Binary Format | Binary Bytes | Binary Offset |
|-------|---------------------|-------------|--------------|--|---------------|--------------|---------------|
| 1     | INSCALIBRATE header | -           | -            | Command header. See <i>Messages</i> on page 25 for more information. | -             | H            | 0             |

| Field | Field Type | ASCII Value | Binary Value | Description   | Binary Format | Binary Bytes | Binary Offset |
|-------|------------|-------------|--------------|---|---------------|--------------|---------------|
| 2     | Offset     | ANT1        | 1            | Use this option to set the INS calibration offset from the IMU to the primary GNSS antenna<br><br><b>Note:</b> The ANT1 option is available only on IMU Grade 2 or higher IMUs. See Models and Features in the <a href="#">OEM7 SPAN Installation and Operation User Manual</a> . | Enum          | 4            | H             |
|       |            | ALIGN       | 8            | Use this option to set the INS calibration offset from the IMU Body frame to ALIGN frame rotation.  |               |              |               |
|       |            | RBV         | 11           | Use this option to set the INS calibration offset from the IMU Body frame to Vehicle frame rotation.  |               |              |               |
| 3     | Trigger    | STOP        | 0            | Ends the INS calibration and uses the current estimate for the RBV offsets  | Enum          | 4            | H+4           |
|       |            | NEW         | 1            | Begins a new single line calibration, overwriting any previous input or cumulative average offset values  |               |              |               |
|       |            | ADD         | 2            | Adds a new path. Only valid for multi-path RBV calibrations   |               |              |               |
|       |            | RESET       | 3            | Resets the calibration process and restores the RBV offsets to previous user input values   |               |              |               |

---

| Field | Field Type  | ASCII Value | Binary Value | Description   | Binary Format | Binary Bytes | Binary Offset |
|-------|-------------|-------------|--------------|---|---------------|--------------|---------------|
| 4     | SDThreshold |             |              | Standard Deviation Threshold<br>(default for lever arm calibration = 0.10 m)<br>(default for RBV calibration = 0.5 degrees) | Float         | 4            | H+8           |

## 4.9 INSCOMMAND

### *INS Control Command*

**Platform: OEM719, OEM729, OEM7500, OEM7700, OEM7720, PwrPak7, HxGN PIM7500**

Use this command to enable or disable INS. When INS is disabled, no INS position, velocity or attitude is output (however IMU data is still available). Also, INS aiding of tracking reacquisition is disabled. If the command is used to disable INS and then re-enable it, the INS system has to go through its alignment procedure (equivalent to issuing a **RESET** command). See the relevant SPAN User Manual for information about the SPAN alignment procedures.

**Message ID: 379**

#### Abbreviated ASCII Syntax:

```
INSCOMMAND action
```

#### Abbreviated ASCII Example:

```
INSCOMMAND ENABLE
```

| Field | Field Type         | ASCII Value     | Binary Value | Description   | Binary Format | Binary Bytes | Binary Offset |
|-------|--------------------|-----------------|--------------|---|---------------|--------------|---------------|
| 1     | INS COMMAND header | -               | -            | Command header. See <i>Messages</i> on page 25 for more information.  | -             | H            | 0             |
| 2     | Action             | RESET           | 0            | Resets the GNSS/INS alignment and restarts the alignment initialization.  | Enum          | 4            | H             |
|       |                    | DISABLE         | 1            | Disables INS navigation.  |               |              |               |
|       |                    | ENABLE          | 2            | Enables INS navigation where alignment initialization starts again.   |               |              |               |
|       |                    | START_NO_TIME   | 3            | Raw IMU data will begin to flow upon system startup. IMU data collection can begin before the receiver has a GNSS solution. (default) |               |              |               |
|       |                    | START_FINE_TIME | 4            | RAWIMU data will only be output after the system reaches FINESTEERING.  |               |              |               |

## 4.10 INSSEED

### *Enable or disable last known SPAN solution*

This command enables or disables the saving and restoration of the last known SPAN solution from NVM.

**Message ID: 1906**

**Abbreviated ASCII Syntax:**

```
INSSEED Command [Validation]
```

**Abbreviated ASCII Example:**

```
INSSEED ENABLE
```

| Field | Field Type     | ASCII Value | Binary Value | Description  | Binary Format | Binary Bytes | Binary Offset |
|-------|----------------|-------------|--------------|--|---------------|--------------|---------------|
| 1     | INSSEED Header | -           | -            | Command header. See <i>Messages</i> on page 25 for more information.       | -             | H            | 0             |
| 2     | Command        | DISABLE     | 0            | Disable the INS seed functionality   | Enum          | 4            | H             |
|       |                | ENABLE      | 1            | Enable the INS seed functionality  |               |              |               |
|       |                | CLEAR       | 2            | Clear the currently saved seed value so it will not be used until re-saved |               |              |               |

| Field | Field Type | ASCII Value | Binary Value | Description   | Binary Format | Binary Bytes | Binary Offset |
|-------|------------|-------------|--------------|---|---------------|--------------|---------------|
| 3     | Validation | VALIDATE    | 0            | Validate INS Seed data using GNSS solution before injecting (default)   | Enum          | 4            | H+4           |
|       |            | INJECT      | 1            | Force an NVM seed value (if available) to be used, without any motion validation.<br><br><div style="border: 1px solid black; padding: 5px; background-color: #f0f0f0;"> <p>Using this option to force the seed to be used can result in an unstable INS solution if the vehicle has moved. For advanced users only.</p> </div> |               |              |               |
| 4     | Reserved   |             |              |   | Ulong         | 4            | H+8           |
| 5     | Reserved   |             |              |   | Ulong         | 4            | H+12          |

## 4.11 INSTHRESHOLDS

### *Change the INS\_HIGH\_VARIANCE Threshold*

**Platform: OEM719, OEM729, OEM7500, OEM7700, OEM7720, PwrPak7, HxGN PIM7500**

The **INSTHRESHOLDS** command allows you to customize the criteria by which the system reports the inertial solution status. This criteria is used to determine whether the solution status is reported as INS\_SOLUTION\_GOOD or INS\_HIGH\_VARIANCE.

This command is especially useful in situations where the system dynamics are known to be challenging or the SPAN system is using a lower grade IMU.

**Message ID: 1448**

#### Abbreviated ASCII Syntax:

```
INSTHRESHOLDS ThresholdConfiguration
```

#### Abbreviated ASCII Example:

```
INSTHRESHOLDS DEFAULT
```

| Field | Field Type              | ASCII Value | Binary Value | Description   | Binary Format | Binary Bytes | Binary Offset |
|-------|-------------------------|-------------|--------------|---|---------------|--------------|---------------|
| 1     | INSTHRESHOLDS header    | -           | -            | Command header. See <i>Messages</i> on page 25 for more information.            | -             | H            | 0             |
| 2     | Threshold Configuration | DEFAULT     | 0            | Standard INS status threshold settings  | Enum          | 4            | H             |
|       |                         | LOW         | 1            | Low INS status threshold settings (only checks the Attitude standard deviation) |               |              |               |
|       |                         | HIGH        | 2            | High INS status threshold settings  |               |              |               |
| 3     | Reserved                |             |              |   | Double        | 8            | H+4           |
| 4     | Reserved                |             |              |   | Double        | 8            | H+12          |
| 5     | Reserved                |             |              |   | Double        | 8            | H+20          |

## 4.12 INSZUPT

### *Request Zero Velocity Update*

**Platform: OEM719, OEM729, OEM7500, OEM7700, OEM7720, PwrPak7, HxGN PIM7500**

Use this command to manually perform a Zero Velocity Update (ZUPT).

NovAtel's SPAN Technology System does ZUPTs automatically. It is not necessary to use this command under normal circumstances.



This command should only be used by advanced users of GNSS/INS and only when the system is truly stationary. Applying a ZUPT while moving will result in severe instability of the solution.

**Message ID: 382**

**Abbreviated ASCII Syntax:**

INSZUPT

| Field | Field Type  | ASCII Value | Binary Value | Description  | Binary Format | Binary Bytes | Binary Offset |
|-------|---|-------------|--------------|--|---------------|--------------|---------------|
| 1     | INSZUPT header  | -           | -            | Command header. See <i>Messages</i> on page 25 for more information. | -             | H            | 0             |
| 2     | Reserved<br>This parameter is optional when using abbreviated ASCII syntax. |             |              |  | BOOL          | 4            | H             |



## 4.13 RELINSAUTOMATION

### *Enables Relative INS on the Rover*

**Platform: OEM719, OEM729, OEM7500, OEM7700, OEM7720, PwrPak7, HxGN PIM7500**

Use this command to configure the Relative INS plug and play feature on the rover receiver. RELINSAUTOMATION enables/disables the plug and play feature, sets the rover COM port to which the master receiver is connected, sets the baud rate for communication, sets the correction transfer rate and enables/disables sending the HEADINGEXTB/HEADINGEXT2B log back to the master receiver.

On issuing this command at the rover receiver, the rover will automatically sync with the master receiver and configure it to send corrections at the specified baud rate and specified data rate.



The recommended method for configuring Relative INS is to use the **RELINSCONFIG** command (see page 867).



This command should only be issued at the rover receiver.



if the rover receiver is not connected to the master receiver using a serial COM port, use the **RELINSCONFIG** command (see page 867).

**Message ID: 1763**

#### Abbreviated ASCII Syntax:

```
RELINSAUTOMATION option [comport] [baudrate] [datarate] [headingextboption]
```

#### Abbreviated ASCII Example:

```
RELINSAUTOMATION enable com2 230400 10 on
```

| Field | Field Type               | ASCII Value | Binary Value | Description  | Binary Format | Binary Bytes | Binary Offset |
|-------|--------------------------|-------------|--------------|--|---------------|--------------|---------------|
| 1     | RELINS AUTOMATION header | -           | -            | Command header. See <i>Messages</i> on page 25 for more information. | -             | H            | 0             |
| 2     | option                   | ENABLE      | 0            | Enables or disables the plug and play feature.                       | Enum          | 4            | H             |
|       |                          | DISABLE     | 1            |  |               |              |               |

| Field | Field Type         | ASCII Value                                       | Binary Value | Description  | Binary Format | Binary Bytes | Binary Offset |
|-------|--------------------|---|--------------|--|---------------|--------------|---------------|
| 3     | comport            | COM1  | 1            | The COM port on the rover receiver to which the master receiver is connected.<br>(default = COM2)            | Enum          | 4            | H+4           |
|       |                    | COM2  | 2            |  |               |              |               |
|       |                    | COM3  | 3            |  |               |              |               |
| 4     | baudrate           | 9600, 19200, 38400, 57600, 115200, 230400, 460800 |              | The baud rate used for communication between the master and rover receivers.                                 | Ulong         | 4            | H+8           |
| 5     | datarate           | 1, 2, 4, 5, 10 or 20 Hz                           |              | The rate at which corrections are transferred between the receivers.<br>(default = 10 Hz)                    | Ulong         | 4            | H+12          |
| 6     | heading extboption | ON<br>OFF   |              | Enables or disables sending the HEADINGEXTB/ HEADINGEXT2B log back to the master receiver.<br>(default = ON) | Enum          | 4            | H+16          |

## 4.14 RELINSCONFIG

### Configure Relative INS

**Platform: OEM719, OEM729, OEM7500, OEM7700, OEM7720, PwrPak7, HxGN PIM7500**

Use this command to configure Relative INS on this receiver.

**Message ID: 1797**

#### Abbreviated ASCII Syntax:

```
RELINSCONFIG enable rxtype [port] [baud] [rateinhz]
```

#### Abbreviated ASCII Example:

```
RELINSCONFIG ENABLE ROVER COM2 230400 10
```

| Field | Field Type           | ASCII Value                                       | Binary Value | Description   | Binary Format | Binary Bytes | Binary Offset |
|-------|----------------------|---|--------------|---|---------------|--------------|---------------|
| 1     | RELINS CONFIG header | -   | -            | Command header. See <i>Messages</i> on page 25 for more information.                            | -             | H            | 0             |
| 2     | enable               | DISABLE   | 0            | Enables or disables the Relative INS functionality.   | Enum          | 4            | H             |
|       |                      | ENABLE  | 1            |   |               |              |               |
| 3     | rxtype               | ROVER   | 1            | Defines the receiver as the master or rover in a Relative INS configuration.                    | Enum          | 4            | H+4           |
|       |                      | MASTER  | 2            |   |               |              |               |
| 4     | port                 | See <i>Table 185: COM Ports</i> on the next page  |              | Communication port used to communicate with the other receiver. (default = COM2)                | Enum          | 4            | H+8           |
| 5     | baud                 | 9600, 19200, 38400, 57600, 115200, 230400, 460800 |              | The baud rate used for communication between the master and rover receivers. (default = 230400) | Ulong         | 4            | H+12          |
| 6     | rateinhz             | 1, 2, 4, 5, 10 or 20 Hz                           |              | The rate at which corrections are transferred between the receivers. (default = 10 Hz)          | Ulong         | 4            | H+16          |

**Table 185: COM Ports**

| <b>Decimal</b> | <b>ASCII</b> | <b>Description</b>              |
|----------------|--------------|---------------------------------|
| 1              | COM1         | COM port 1                      |
| 2              | COM2         | COM port 2                      |
| 3              | COM3         | COM port 3                      |
| 13             | USB1         | USB port 1                      |
| 14             | USB2         | USB port 2                      |
| 15             | USB3         | USB port 3                      |
| 19             | COM4         | COM port 4                      |
| 23             | ICOM1        | IP virtual COM port 1           |
| 24             | ICOM2        | IP virtual COM port 2           |
| 25             | ICOM3        | IP virtual COM port 3           |
| 29             | ICOM4        | IP virtual COM port 4           |
| 31             | COM5         | COM port 5                      |
| 46             | ICOM5        | IP virtual COM port 5           |
| 47             | ICOM6        | IP virtual COM port 6           |
| 48             | ICOM7        | IP virtual COM port 7           |
| 49             | SCOM1        | Scripted application COM port 1 |
| 50             | SCOM2        | Scripted application COM port 2 |
| 51             | SCOM3        | Scripted application COM port 3 |
| 52             | SCOM4        | Scripted application COM port 4 |

## 4.15 SETALIGNMENTVEL

### *Set the Minimum Kinematic Alignment Velocity*

**Platform: OEM719, OEM729, OEM7500, OEM7700, OEM7720, PwrPak7, HxGN PIM7500**

Use the **SETALIGNMENTVEL** command to adjust the minimum required velocity for a kinematic alignment.

Useful in cases, such as helicopters, where alignment velocity should be increased to prevent a poor alignment before the vehicle/aircraft is able to flight straight and level.

**Message ID: 1397**

#### **Abbreviated ASCII Syntax:**

```
SETALIGNMENTVEL velocity
```

#### **Abbreviated ASCII Example**

```
SETALIGNMENTVEL 5.0
```

| Field | Field Type             | ASCII Value                               | Binary Value | Description  | Binary Format | Binary Bytes | Binary Offset |
|-------|------------------------|---|--------------|--|---------------|--------------|---------------|
| 1     | SETALIGNMENTVEL header | -   | -            | Command header. See <i>Messages</i> on page 25 for more information. | -             | H            | 0             |
| 2     | Velocity               | Minimum:<br>0.2 m/s<br>(Default is 5 m/s) |              | The minimum velocity, in m/s, required to kinematically align.       | Double        | 8            | H             |

## 4.16 SETHEAWEWINDOW

### *Set Heave Filter Length*

**Platform:** OEM719, OEM729, OEM7500, OEM7700, OEM7720, PwrPak7, HxGN PIM7500

Use this command to control the length of the heave filter. This filter determines the heave (vertical displacement) of the IMU, relative to a long term level surface.

**Message ID:** 1383

**Abbreviated ASCII Syntax:**

```
SETHEAWEWINDOW filterlength
```

**Abbreviated ASCII Example:**

```
SETHEAWEWINDOW 35
```

| Field | Type                  | ASCII Value                          | Binary Value | Description  | Binary Format | Binary Bytes | Binary Offset |
|-------|-----------------------|--------------------------------------|--------------|--|---------------|--------------|---------------|
| 1     | SETHEAWEWINDOW header | -                                    | -            | Command header. See <i>Messages</i> on page 25 for more information.                                     | -             | H            | 0             |
| 2     | Filter Length         | Integer (1 - 300 s) (default = 20 s) |              | This filter length will be used in the heave filter. Typically, set the filter length to 5 x wave period | Long          | 4            | H             |

## 4.17 SETIMUPORTPROTOCOL

### *Sets the Protocol Used for the IMU Serial Port*

**Platform: OEM719, OEM729, OEM7500, OEM7700, OEM7720, PwrPak7, HxGN PIM7500**

Use the **SETIMUPORTPROTOCOL** command to change the IMU serial port to use either RS-232 or RS-422 protocol. This overrides the default configured internally when the **CONNECTIMU** command is sent.



Before changing the IMU serial port protocol:

1. Make sure the receiver port connected to the IMU is capable of RS-422 protocol. Refer to the [OEM7 Installation and Operation User Manual](#) for information about the receiver serial ports.
2. The IMU data message is input into the receiver at that particular protocol.

**Message ID: 1767**

#### **Abbreviated ASCII Syntax:**

```
SETIMUPORTPROTOCOL SerialProtocol
```

#### **Abbreviated ASCII Example:**

```
SETIMUPORTPROTOCOL RS422
```

| Field | Field Type                 | ASCII Value    | Binary Value | Description  | Binary Format | Binary Bytes | Binary Offset |
|-------|----------------------------|----------------|--------------|--|---------------|--------------|---------------|
| 1     | SETIMUPORT PROTOCOL header | -              | -            | Command header. See <i>Messages</i> on page 25 for more information. | -             | H            | 0             |
| 2     | Serial Protocol            | RS232<br>RS422 |              | The protocol for the IMU serial port.                                | Enum          | 4            | H             |

## 4.18 SETIMUSPECS

### *Specify Error Specifications and Data Rate*

**Platform: OEM719, OEM729, OEM7500, OEM7700, OEM7720, PwrPak7, HxGN PIM7500**



This command should only be used by advanced users of GNSS/INS.

Use the **SETIMUSPECS** command to specify the error specifications and data rate for the desired IMU. If the default specs for the supported models are different than the unit used then this command can be used to override the default values.

This command is only available for the following IMUs:

- Honeywell HG1930 (default specifications are for the AA99/CA50 model)
- Honeywell HG1900 (default specifications are for the CA29/CA50 model)

**Message ID: 1295**

#### **Abbreviated ASCII Syntax:**

```
SETIMUSPECS DataRate AccelBias AccelVRW GyroBias GyroARW AccelSFError
GyroSFError [DataLatency]
```

#### **Abbreviated ASCII Example: (iMAR-FSAS Specs)**

```
SETIMUSPECS 200 1 .0198 0.75 0.0028 300 300 2.5
```

| Field | Field Type         | ASCII Value      | Binary Value | Description  | Binary Format | Binary Bytes | Binary Offset |
|-------|--------------------|------------------|--------------|--|---------------|--------------|---------------|
| 1     | SETIMUSPECS header | -                | -            | Command header. See <i>Messages</i> on page 25 for more information. | -             | H            | 0             |
| 2     | Data Rate          | 100 Hz to 400 Hz |              | Data rate of the IMU   | Ushort        | 2            | H             |
| 3     | Accel Bias         | -                |              | Total accelerometer bias in milli-g                                  | Double        | 8            | H+2           |
| 4     | Accel VRW          | -                |              | Accelerometer velocity random walk in m/s/rt-hr                      | Double        | 8            | H+10          |
| 5     | Gyro Bias          | -                |              | Total gyroscope bias in deg/hr                                       | Double        | 8            | H+18          |
| 6     | Gyro ARW           | -                |              | Gyroscope angular random walk in deg/rt-hr                           | Double        | 8            | H+26          |



| Field | Field Type               | ASCII Value | Binary Value | Description  | Binary Format | Binary Bytes | Binary Offset |
|-------|--------------------------|-------------|--------------|--|---------------|--------------|---------------|
| 7     | Accel Scale Factor Error | > 0         |              | Accelerometer scale factor error in parts per million. Optional. Default = 1000 ppm.   | Ulong         | 4            | H+34          |
| 8     | Gyro Scale Factor Error  | > 0         |              | Gyroscopic scale factor error in parts per million. Optional. Default = 1000 ppm.  | Ulong         | 4            | H+38          |
| 9     | Data Latency             | > 0         |              | Time delay in milliseconds from the time of validity of the IMU data to the time the input pulse is received by the SPAN enabled receiver. This may include filtering delays, processing delays and transmission times depending on the timing method (TOV, ASYNC, SYNC) and the internal IMU handling. Optional. Default = 0.0. | Double        | 8            | H+42          |
| 10    | Reserved                 | -           |              | Reserved   | Ulong         | 4            | H+50          |
| 11    | CRC                      | -           |              | 32-bit CRC   | Hex           | 4            | H+54          |

## 4.19 SETINITAZIMUTH

### *Set Initial Azimuth and Standard Deviation*

**Platform: OEM719, OEM729, OEM7500, OEM7700, OEM7720, PwrPak7, HxGN PIM7500**

Use this command to start SPAN operation with a previously known azimuth. Azimuth is the weakest component of a coarse alignment and is also the easiest to know from an external source (i.e., like the azimuth of roadway). When using this command, SPAN operation through alignment will appear the same as with a usual coarse alignment. Roll and pitch is determined using averaged gyro and accelerometer measurements. The input azimuth is used rather than what is computed by the normal coarse alignment routine.

- Input azimuth values must be accurate for good system performance.
- Sending **SETINITAZIMUTH** resets the SPAN filter. Following realignment, vehicle dynamics are required for the filter to re-converge. Bridging performance is poor before filter convergence.
- The entered azimuth angle is with respect to the configured output frame. This is generally the vehicle frame unless a User Frame offset has been configured using the **SETINSROTATION** command (see page 877). All offsets should be entered before entering the **SETINITAZIMUTH** command.
- This command is not save configurable and must be re-entered after each start-up. The command can be entered at any time and will be used automatically when the system is ready to begin alignment.



Azimuth is positive in a clockwise direction when looking towards the z-axis origin.

**Message ID: 863**

#### **Abbreviated ASCII Syntax:**

```
SETINITAZIMUTH azimuth azSTD
```

#### **Abbreviated ASCII Example:**

```
SETINITAZIMUTH 90 5
```

| Field | Field Type             | ASCII Value | Binary Value | Description  | Binary Format | Binary Bytes | Binary Offset |
|-------|------------------------|-------------|--------------|--|---------------|--------------|---------------|
| 1     | SETINIT AZIMUTH header | -           | -            | Command header. See <i>Messages</i> on page 25 for more information. | -             | H            | 0             |
| 2     | azimuth                | 0 to 360    |              | Input azimuth angle (degrees)  | Double        | 8            | H             |
| 3     | azSTD                  | 1 to 25     |              | Input azimuth standard deviation angle (degrees)                     | Float         | 4            | H+8           |

## 4.20 SETINSPROFILE

*Sets filter behavior depending on system environment*

**Platform: OEM719, OEM729, OEM7500, OEM7700, OEM7720, PwrPak7, HxGN PIM7500**

This command sets specific filter behavior depending on the environment the system is installed in. The DEFAULT profile is the legacy setting from earlier SPAN products. The other profiles make changes specific to that environment.

The BASIC INS Profiles are available to all SPAN software models, but the enhanced configurations, denoted by "PLUS", are restricted by the SPAN model. The enhanced configurations allow for enhanced profile behavior such as Dead Reckoning for land and Heave for marine. See the [OEM7 SPAN Installation and Operation User Manual](#) for a detailed description of each profile's effect.

**Message ID: 1944**

**Abbreviated ASCII Syntax:**

```
SETINSPROFILE profile
```

**Abbreviated ASCII Example:**

```
SETINSPROFILE LAND_BASIC
```

| Field | Field Type           | ASCII Value | Binary Value | Description  | Binary Format | Binary Bytes | Binary Offset |
|-------|----------------------|-------------|--------------|--|---------------|--------------|---------------|
| 1     | SETINSPROFILE Header | -           | -            | Command header. See <i>Messages</i> on page 25 for more information. | -             | H            | 0             |

| Field | Field Type | ASCII Value     | Binary Value | Description  | Binary Format | Binary Bytes | Binary Offset |
|-------|------------|-----------------|--------------|--|---------------|--------------|---------------|
| 2     | Profile    | DEFAULT         | 0            | Default INS profile with standard SPAN behavior.   | Enum          | 4            | H             |
|       |            | LAND_BASIC      | 1            | Basic INS profile for land vehicles  |               |              |               |
|       |            | MARINE_BASIC    | 2            | Basic INS profile for marine vehicles  |               |              |               |
|       |            | FIXEDWING_BASIC | 3            | Basic INS profile for fixed wing aircraft  |               |              |               |
|       |            | Reserved        | 4            | Reserved   |               |              |               |
|       |            | VTOL_BASIC      | 5            | Basic INS profile for vertical takeoff and landing vehicles (UAVs, helicopters, etc.)                |               |              |               |
|       |            | RAIL_BASIC      | 6            | Basic INS profile for trains   |               |              |               |
|       |            | LAND_PLUS       | 33           | Enhanced INS profile for land vehicles. Enables Dead Reckoning. Requires INS Enhanced Profile Model. |               |              |               |
|       |            | MARINE_PLUS     | 34           | Enhanced INS profile for marine vehicles. Enables Heave. Requires INS Enhanced Profile Model.        |               |              |               |

## 4.21 SETINSROTATION

***Specifies rotational offsets between the IMU frame and other reference frames***

**Platform: OEM719, OEM729, OEM7500, OEM7700, OEM7720, PwrPak7, HxGN PIM7500**

Use the **SETINSROTATION** command to specify rotational offsets between the IMU frame and other reference frames, such as the vehicle frame or an ALIGN baseline. Offsets must be entered as the rotation from the IMU body frame, to the frame of interest. The order of rotations is Z, X, Y. All rotations are right handed.



It is very important to follow the order of rotations (Z, X, Y) when determining the rotations from IMU body frame to frame of interest.



To specify translational offsets between frames, see the **SETINSTRANSULATION** command on page 880.

**Message ID: 1921**

**Abbreviated ASCII Syntax:**

```
SETINSROTATION INSRotation XRotation YRotation ZRotation [XRotationSD]
[YRotationSD] [ZRotationSD]
```

**Abbreviated ASCII Example:**

```
SETINSROTATION RBV 0 0 90 0.0 0.0 0.0
```

| Field | Field Type            | ASCII Value  | Binary Value | Description  | Binary Format | Binary Bytes | Binary Offset |
|-------|-----------------------|--|--------------|--|---------------|--------------|---------------|
| 1     | SETINSROTATION Header | -  | -            | Command header. See <i>Messages</i> on page 25 for more information. | -             | H            | 0             |
| 2     | INS Rotation          | <i>Table 186: Rotational Offset Types on the next page</i> |              | Rotational offset to be set.   | Enum          | 4            | H             |
| 3     | XRotation             | ±180   |              | X rotation offset from IMU origin (degrees)                          | Float         | 4            | H+4           |

| Field | Field Type  | ASCII Value | Binary Value | Description  | Binary Format | Binary Bytes | Binary Offset |
|-------|-------------|-------------|--------------|--|---------------|--------------|---------------|
| 4     | YRotation   | ±180        |              | Y rotation offset from IMU origin (degrees)                                | Float         | 4            | H+8           |
| 5     | ZRotation   | ±180        |              | Z rotation offset from IMU origin (degrees)                                | Float         | 4            | H+12          |
| 6     | XRotationSD | 0 to 45     |              | Optional X rotation offset standard deviation (degrees)<br>Default: 0.0    | Float         | 4            | H+16          |
| 7     | YRotationSD | 0 to 45     |              | Optional Y translation offset standard deviation (degrees)<br>Default: 0.0 | Float         | 4            | H+20          |
| 8     | ZRotationSD | 0 to 45     |              | Optional Z translation offset standard deviation (degrees)<br>Default: 0.0 | Float         | 4            | H+24          |
| 9     | Reserved    |             |              |  | Long          | 4            | H+28          |

**Table 186: Rotational Offset Types**

| ASCII Value | Binary Value | Description   |
|-------------|--------------|---|
| USER        | 4            | Rotation from the IMU body frame to the user output frame.<br>This offset shifts the attitude information in the INSPVA,INSPOS, INSVEL, INSATT, and INSSPD logs, along with their short header and extended versions. |
| MARK1       | 5            | Rotation from the IMU body frame to the desired output for MARK1.<br>This offset rotates the attitude information in the MARK1PVA log.  |
| MARK2       | 6            | Rotation from the IMU body frame to the desired output for MARK2.<br>This offset rotates the attitude information in the MARK2PVA log.  |

| ASCII Value | Binary Value | Description  |
|-------------|--------------|--|
| ALIGN       | 8            | <p>Rotation from the IMU body frame to an ALIGN dual antenna solution.</p> <div style="border: 1px solid black; padding: 5px; margin-top: 10px;">  <p>When using a dual antenna ALIGN solution with SPAN, this offset will be calculated automatically if translational offsets to both the primary and secondary GNSS antennas are provided using the <b>SETINSTRANSULATION</b> command on the next page.</p> </div> |
| MARK3       | 9            | <p>Rotation from the IMU body frame to the desired output for MARK3.<br/>This offset rotates the attitude information in the MARK3PVA log.</p>   |
| MARK4       | 10           | <p>Rotation from the IMU body frame to the desired output for MARK4.<br/>This offset rotates the attitude information in the MARK4PVA log.</p>   |
| RBV         | 11           | <p>Rotation from the IMU body frame to the vehicle frame.</p>  |
| RBM         | 12           | <p>Rotation from the IMU body frame to the gimbal mount body frame.</p>  |

## 4.22 SETINSTRANSALATION

***Specifies translational offsets between the IMU frame and other reference frames***

**Platform: OEM719, OEM729, OEM7500, OEM7700, OEM7720, PwrPak7, HxGN PIM7500**

Use the **SETINSTRANSALATION** command to specify translational offsets between the IMU frame and other reference frames, including GNSS antennas or the desired output frame. Offsets must be entered as the vector from the IMU, to the frame or position of interest. Offsets can be entered either in the IMU body frame, or the vehicle frame; offsets in the vehicle frame will be automatically rotated into the IMU body frame using the best available IMU Body to Vehicle Rotation (RBV).

For details on entering the RBV rotation or other angular offsets, see the **SETINSROTATION** command on page 877.

**Message ID: 1920**

### Abbreviated ASCII Syntax:

```
SETINSTRANSALATION INStranslation XTranslation YTranslation ZTranslation
[XTranslationSD] [YTranslationSD] [ZTranslationSD] [InputFrame]
```

### Abbreviated ASCII Example:

```
SETINSTRANSALATION USER 1.0 2.0 3.0 0.05 0.05 0.05 VEHICLE
```

| Field | Field Type                      | ASCII Value   | Binary Value | Description   | Binary Format | Binary Bytes | Binary Offset |
|-------|---------------------------------|---|--------------|---|---------------|--------------|---------------|
| 1     | SETINS<br>TRANSLATION<br>Header | -   | -            | Command header.<br>See <i>Messages</i> on<br>page 25 for more<br>information. | -             | H            | 0             |
| 2     | InsTranslation                  | See Table 187:<br><i>Translation Offset<br/>Types</i> on the next<br>page |              | Translation offset to<br>be set   | Enum          | 4            | H             |
| 3     | XTranslation                    | ±100  |              | X translation offset<br>from IMU origin (m)                                   | Float         | 4            | H+4           |
| 4     | YTranslation                    | ±100  |              | Y translation offset<br>from IMU origin (m)                                   | Float         | 4            | H+8           |
| 5     | ZTranslation                    | ±100  |              | Z translation offset<br>from IMU origin (m)                                   | Float         | 4            | H+12          |
| 6     | XTranslationSD                  | 0 to 10   |              | Optional X translation<br>offset standard<br>deviation (m)                    | Float         | 4            | H+16          |



| Field | Field Type     | ASCII Value  | Binary Value | Description  | Binary Format | Binary Bytes | Binary Offset |
|-------|----------------|--|--------------|--|---------------|--------------|---------------|
| 7     | YTranslationSD | 0 to 10  |              | Optional Y translation offset standard deviation (m) | Float         | 4            | H+20          |
| 8     | ZTranslationSD | 0 to 10  |              | Optional Z translation offset standard deviation (m) | Float         | 4            | H+24          |
| 9     | InputFrame     | <i>Table 188: Translation Input Frame on the next page</i> |              | Optional input frame for translation offset values   | Enum          | 4            | H+48          |



For the ANT1, ANT2, EXTERNAL and GIMBAL translations, the standard deviation defaults are set to 10% of the translation value (up to a max of 10 metres).



If you are uncertain of the standard deviation values for an offset, err on the side of a larger standard deviation.

**Table 187: Translation Offset Types**

| ASCII Value | Binary Value | Description   |
|-------------|--------------|---|
| ANT1        | 1            | Offset from the IMU center of navigation to the phase center of the primary GNSS antenna.   |
| ANT2        | 2            | Offset from the IMU center of navigation to the phase center of the secondary GNSS antenna.   |
| EXTERNAL    | 3            | Offset from the IMU center of navigation to the external position source location.<br>This offset type is for use with the <b>EXTERNALPVAS</b> command (see page 847).  |
| USER        | 4            | Translation from the IMU center of navigation to the user output location.<br>This offset shifts the position and velocity information in the INSPVA, INSPOS, INSVEL, INSATT, and INSSPD logs, along with their short header and extended versions. |
| MARK1       | 5            | Translation from the IMU center of navigation to the MARK1 output location.<br>This offset shifts the position and velocity information in the MARK1PVA log.  |

| ASCII Value | Binary Value | Description   |
|-------------|--------------|---|
| MARK2       | 6            | Translation from the IMU center of navigation to the MARK2 output location. This offset shifts the position and velocity information in the MARK2PVA log. |
| GIMBAL      | 7            | Translation from the IMU center of navigation to the gimbal mount center of rotation.   |
| MARK3       | 9            | Translation from the IMU center of navigation to the MARK3 output location. This offset shifts the position and velocity information in the MARK3PVA log. |
| MARK4       | 10           | Translation from the IMU center of navigation to the MARK4 output location. This offset shifts the position and velocity information in the MARK4PVA log. |

**Table 188: Translation Input Frame**

| ASCII Value | Binary Value | Description  |
|-------------|--------------|--|
| IMUBODY     | 0            | Offset is provided in the IMU enclosure frame.<br>Default: IMUBODY   |
| VEHICLE     | 1            | Offset is provided in the vehicle frame.<br>Offsets entered in the vehicle frame will be automatically rotated into the IMU frame using the best available RBV (rotation from IMU Body to Vehicle) information when required.<br>Vehicle frame offsets should only be used if the RBV is known accurately, either through user measurement or calibration.<br>The order of entry for vehicle frame offsets and the RBV rotation does not matter. |

## 4.23 SETINSUPDATE

### *Enable/Disable INS Filter Updates*



This command should only be used by advanced users of GNSS+INS.

**Platform: OEM719, OEM729, OEM7500, OEM7700, OEM7720, PwrPak7, HxGN PIM7500**

Use this command to enable or disable the available INS filter updates.

**Message ID: 1821**

**Abbreviated ASCII Syntax:**

```
SETINSUPDATE INSUpdate Trigger
```

**Abbreviated ASCII Example:**

```
SETINSUPDATE ZUPT DISABLE
```

| Field | Field Type          | ASCII Value | Binary Value | Description  | Binary Format | Binary Bytes | Binary Offset |
|-------|---------------------|-------------|--------------|--|---------------|--------------|---------------|
| 1     | SETINSUPDATE header | -           | -            | Command header. See <i>Messages</i> on page 25 for more information. | -             | H            | 0             |
| 2     | INSUpdate           | POS         | 0            | Position updates   | Enum          | 4            | H             |
|       |                     | ZUPT        | 1            | Zero velocity updates  |               |              |               |
|       |                     | PSR         | 2            | Pseudorange updates  |               |              |               |
|       |                     | ADR         | 3            | Carrier phase updates  |               |              |               |
|       |                     | DOPPLER     | 4            | Doppler updates  |               |              |               |
|       |                     | ALIGN       | 5            | Heading updates  |               |              |               |
| 3     | Trigger             | DISABLE     | 0            | Disable the INS update specified in the INSUpdate field.             | Enum          | 4            | H+4           |
|       |                     | ENABLE      | 1            | Enable the INS update specified in the INSUpdate field.              |               |              |               |

## 4.24 SETMAXALIGNMENTTIME

### *Set a Time Limit for Static Course Alignment*

**Platform: OEM719, OEM729, OEM7500, OEM7700, OEM7720, PwrPak7, HxGN PIM7500**

Use this command to set a maximum time limit allowed for static coarse alignments. Coarse alignments typically take under 60 seconds, but in heavy vibration conditions they can take much longer trying to compensate for the vibration induced noise. This command is used to cap the time to a specific length.



This command is for advanced users only. Alignment accuracy cannot be guaranteed if the alignment time is capped using this command.

**Message ID: 1800**

#### **Abbreviated ASCII Syntax:**

```
SETMAXALIGNMENTTIME switch [duration]
```

#### **Abbreviated ASCII Example:**

```
SETMAXALIGNMENTTIME ENABLE 90
```

| Field | Field Type                  | ASCII Value | Binary Value | Description  | Binary Format | Binary Bytes | Binary Offset |
|-------|-----------------------------|-------------|--------------|--|---------------|--------------|---------------|
| 1     | SETMAX ALIGNMENTTIME header | -           | -            | Command header. See <i>Messages</i> on page 25 for more information. | -             | H            | 0             |
| 2     | switch                      | DISABLE     | 0            | Disables the static alignment time limit.                            | Enum          | 4            | H             |
|       |                             | ENABLE      | 1            | Enables the static alignment time limit.                             |               |              |               |
| 3     | duration                    | 30 - 300    |              | Maximum static alignment time in seconds. Default is 180.            | Ulong         | 4            | H+4           |

## 4.25 SETRELINSOUTPUTFRAME

### *Sets the Relative INS Output Frame*

**Platform: OEM719, OEM729, OEM7500, OEM7700, OEM7720, PwrPak7, HxGN PIM7500**

Use this command to change the frame of the output solution provided in the RELINSPVA and SYNCRELINSPVA logs. See **RELINSPVA** log on page 999 and **SYNCRELINSPVA** log on page 1003 for information about these logs.

See [OEM7 SPAN Installation and Operation User Manual](#) for information about the Relative INS functionality.

**Message ID: 1775**

#### Abbreviated ASCII Syntax:

```
SETRELINSOUTPUTFRAME OutputFrame [DiffCriteria]
```

#### Abbreviated ASCII Example:

```
SETRELINSOUTPUTFRAME ECEF TRUE
```

| Field | Field Type                   | ASCII Value | Binary Value | Description  | Binary Format | Binary Bytes | Binary Offset |
|-------|------------------------------|-------------|--------------|--|---------------|--------------|---------------|
| 1     | SETRELINS OUTPUTFRAME header | -           | -            | Command header. See <i>Messages</i> on page 25 for more information.                                       | -             | H            | 0             |
| 2     | OutputFrame                  | ROVER       | 1            | Frame of the output solution in the RELINSPVA and SYNCRELINSPVA logs.                                      | Enum          | 4            | H             |
|       |                              | MASTER      | 2            | ROVER – the output frame of the rover INS solution<br>MASTER – the output frame of the master INS solution |               |              |               |
|       |                              | ECEF        | 3            | ECEF – Earth Centered Earth Fixed  |               |              |               |
|       |                              | LOCALLEVEL  | 4            | LOCALLEVEL – Local level<br>The default is the ROVER.  |               |              |               |

| Field | Field Type   | ASCII Value | Binary Value | Description   | Binary Format | Binary Bytes | Binary Offset |
|-------|--------------|-------------|--------------|---|---------------|--------------|---------------|
| 3     | DiffCriteria | FALSE       | 0            | The delta solution is computed as Rover minus Master. (default) | Bool          | 1            | H+4           |
|       |              | TRUE        | 1            | The delta solution is computed as Master minus Rover.           |               |              |               |

## 4.26 SETUPSENSOR

### *Add a new sensor object*

**Platform: OEM719, OEM729, OEM7500, OEM7700, OEM7720, PwrPak7, HxGN PIM7500**

Use this command to add a new sensor object to the system. A sensor object consists of an ID, an Event\_Out line and an Event\_In line. This is an intended as a simplified way to set up triggering to and from a sensor rather than configuring all connections independently. It also allows for event pulses to be sent to a sensor at specific GPS times (see the **TIMEEVENTPULSE** command on page 891).

**Message ID: 1333**

#### **Abbreviated ASCII Syntax:**

```
SETUPSENSOR SensorID EventOut OPP OAP EventIn EIC IPP ITB MITG
```

#### **Abbreviated ASCII Example:**

```
SETUPSENSOR SENSOR3 MARK1 POSITIVE 2 MARK4 EVENT POSITIVE 0 2
```

| Field | Field Type          | ASCII Value | Binary Value | Description  | Binary Format | Binary Bytes | Binary Offset |
|-------|---------------------|-------------|--------------|--|---------------|--------------|---------------|
| 1     | SETUP SENSOR header | -           | -            | Command header. See <i>Messages</i> on page 25 for more information.     | -             | H            | 0             |
| 2     | Sensor ID           | SENSOR1     | 0            | The sensor to configure.   | Enum          | 4            | H             |
|       |                     | SENSOR2     | 1            |  |               |              |               |
|       |                     | SENSOR3     | 2            |  |               |              |               |
| 3     | EventOut            | MARK1       | 0            | Associate a specific MARK Event_Out line to this sensor configuration.   | Enum          | 4            | H+4           |
|       |                     | MARK2       | 1            |  |               |              |               |
|       |                     | MARK3       | 2            |  |               |              |               |
|       |                     | MARK4       | 3            |  |               |              |               |
| 4     | OPP                 | NEGATIVE    | 0            | Mark output pulse polarity   | Enum          | 4            | H+8           |
|       |                     | POSITIVE    | 1            |  |               |              |               |
| 5     | OAP                 | 2 - 500     |              | Mark output active period in milliseconds. Value must be divisible by 2. | Ulong         | 4            | H+12          |

| Field | Field Type | ASCII Value           | Binary Value | Description   | Binary Format | Binary Bytes | Binary Offset |
|-------|------------|-----------------------|--------------|---|---------------|--------------|---------------|
| 6     | EventIn    | MARK1                 | 0            | Associate a specific MARK Event_In line to this sensor configuration. | Enum          | 4            | H+16          |
|       |            | MARK2                 | 1            |   |               |              |               |
|       |            | MARK3                 | 2            |   |               |              |               |
|       |            | MARK4                 | 3            |   |               |              |               |
| 7     | EIC        | DISABLE               | 0            | Event in control  | Enum          | 4            | H+20          |
|       |            | EVENT                 | 1            |   |               |              |               |
| 8     | IPP        | NEGATIVE              | 0            | Mark input pulse polarity   | Enum          | 4            | H+24          |
|       |            | POSITIVE              | 1            |   |               |              |               |
| 9     | ITB        | -99999999 to 99999999 |              | Mark input time bias in milliseconds                                  | Long          | 4            | H+28          |
| 10    | ITG        | 2 to 3599999          |              | Mark input time guard in milliseconds                                 | Ulong         | 4            | H+32          |



The Event\_In and Event\_Out options available are dependent on the receiver used in the SPAN system. For information about the Event lines supported, see the Strobe Specifications for the receiver in the [OEM7 SPAN Installation and Operation User Manual](#).



MARK3 and MARK4 are available only on SPAN systems with an OEM7700 or OEM7720 receiver.



## 4.27 SETWHEELPARAMETERS

### *Set Wheel Parameters*

**Platform: OEM719, OEM729, OEM7500, OEM7700, OEM7720, PwrPak7, HxGN PIM7500**

The **SETWHEELPARAMETERS** command can be used when wheel sensor data is available. It gives the filter a good starting point for the wheel size scale factor.

**Message ID: 847**

#### Abbreviated ASCII Syntax:

```
SETWHEELPARAMETERS ticks circ reserved
```

#### Abbreviated ASCII Example:

```
SETWHEELPARAMETERS 58 1.96 1.0
```

| Field | Field Type                 | ASCII Value | Binary Value | Description  | Binary Format | Binary Bytes   | Binary Offset |
|-------|----------------------------|-------------|--------------|--|---------------|----------------|---------------|
| 1     | SETWHEEL PARAMETERS header | -           | -            | Command header. See <i>Messages</i> on page 25 for more information. | -             | H              | 0             |
| 2     | Ticks                      | 1-10000     |              | Number of ticks per revolution                                       | Ushort        | 4 <sup>1</sup> | H             |
| 3     | Circ                       | 0.1-100     |              | Wheel circumference (m) (default = 1.96 m)                           | Double        | 8              | H+4           |
| 4     | Reserved                   | -           |              | Reserved field. Set to 1.0 on input.                                 | Double        | 8              | H+12          |



Fields 2 and 3 are used with an estimated scale factor to determine the distance traveled.

<sup>1</sup>In the binary log case, an additional 2 bytes of padding are added to maintain 4 byte alignment.

## 4.28 TAGNEXTMARK

### *Tags the Next Incoming Mark Event*

**Platform: OEM719, OEM729, OEM7500, OEM7700, OEM7720, PwrPak7, HxGN PIM7500**

Use this command to tag the next incoming mark event on the selected mark with a 32-bit number. This is available in the **TAGGEDMARK1PVA, TAGGEDMARK2PVA, TAGGEDMARK3PVA and TAGGEDMARK4PVA** log (see page 1006) to easily associate the PVA log with a supplied event.

**Message ID: 1257**

**Abbreviated ASCII Syntax:**

```
TAGNEXTMARK Mark Tag
```

**Abbreviated ASCII Example:**

```
TAGNEXTMARK MARK1 1234
```

| Field | Field Type         | ASCII Value | Binary Value | Description  | Binary Format | Binary Bytes | Binary Offset |
|-------|--------------------|-------------|--------------|--|---------------|--------------|---------------|
| 1     | TAGNEXTMARK header | -           | -            | Command header. See <i>Messages</i> on page 25 for more information. | -             | H            | 0             |
| 2     | Mark               | MARK1       | 0            | Event line   | Enum          | 4            | H             |
|       |                    | MARK2       | 1            |  |               |              |               |
|       |                    | MARK3       | 2            |  |               |              |               |
|       |                    | MARK4       | 3            |  |               |              |               |
| 3     | Tag                | -           | -            | Tag for next mark event  | Ulong         | 4            | H+4           |



The Mark options available are dependent on the receiver used in the SPAN system. For information about the Event lines supported, see the Strobe Specifications for the receiver in the [OEM7 SPAN Installation and Operation User Manual](#).

## 4.29 TIMEDEVENTPULSE

### *Add a new camera event*

**Platform: OEM719, OEM729, OEM7500, OEM7700, OEM7720, PwrPak7, HxGN PIM7500**

Use this command to add a new camera event to the system. **TIMEDEVENTPULSE** sends a pulse on the sensor MARK output at the selected GPS time and sets the trigger on the sensor MARK input to be tagged with an event ID (see the **TAGGEDMARK1PVA**, **TAGGEDMARK2PVA**, **TAGGEDMARK3PVA** and **TAGGEDMARK4PVA** log on page 1006). The lines connected to each sensor are configured using the **SETUPSENSOR** command (see page 887).



A maximum of 10 unprocessed events can be buffered into the system. A **TIMEDEVENTPULSE** command must be entered at least 1 second prior to the requested event time.

**Message ID: 1337**

#### Abbreviated ASCII Syntax:

```
TIMEDEVENTPULSE SensorID GPSWeek GPSSeconds [Event ID]
```

#### Abbreviated ASCII Example:

```
TIMEDEVENTPULSE -1 1617 418838 100
```

| Field | Field Type               | ASCII Value   | Binary Value    | Description   | Binary Format | Binary Bytes | Binary Offset |
|-------|--------------------------|---------------|-----------------|---|---------------|--------------|---------------|
| 1     | TIMED EVENT PULSE header | -             | -               | Command header. See <i>Messages</i> on page 25 for more information.  | -             | H            | 0             |
| 2     | Sensor ID                | ALL           | -1 (0xFFFFFFFF) | The sensor(s) affected by the trigger command.  | Long          | 4            | H             |
|       |                          | SENSOR1       | 0x01            | The decimal representation of the combination of bits 0-2 can be used to select a combination of active sensors (e.g. 5 [101] will select sensors 1 and 3). |               |              |               |
|       |                          | SENSOR2       | 0x02            |   |               |              |               |
|       |                          | SENSOR3       | 0x04            |   |               |              |               |
| 3     | GPS Week                 | 0 - MAX Ulong |                 | The GPS week that triggers the event.   | Ulong         | 4            | H+4           |

| <b>Field</b> | <b>Field Type</b> | <b>ASCII Value</b> | <b>Binary Value</b> | <b>Description</b>   | <b>Binary Format</b> | <b>Binary Bytes</b> | <b>Binary Offset</b> |
|--------------|-------------------|--------------------|---------------------|--|----------------------|---------------------|----------------------|
| 4            | GPS Seconds       | 0 - 604800         |                     | The GPS week seconds that triggers the event.  | Double               | 8                   | H+8                  |
| 5            | Event ID          | 0- MAX Ulong       |                     | The event's identifier, used to tag the TAGGEDMARKxPVA logs if a sensor input is enabled.<br>Optional<br>Default = 0 | Ulong                | 4                   | H+16                 |

## 4.30 WHEELVELOCITY

### *Wheel Velocity for INS Augmentation*

**Platform: OEM719, OEM729, OEM7500, OEM7700, OEM7720, PwrPak7, HxGN PIM7500**

Use the **WHEELVELOCITY** command to input wheel sensor data into the OEM7 receiver.



This command should be used only if the wheel sensor cannot be directly connected to a wheel sensor port in the SPAN system.



When wheel sensor data is entered using this command, only the Cumulative Ticks/s value is used by the system. Values entered for Wheel Velocity and Float Wheel Velocity are not used at this time.



This command should be input at 1 Hz and synced to the receiver 1 Hz PPS for optimized performance.

**Message ID: 504**

#### Abbreviated ASCII Example:

```
WHEELVELOCITY 123 8 10 0 0 0 0 40
WHEELVELOCITY 123 8 10 0 0 0 0 80
WHEELVELOCITY 123 8 10 0 0 0 0 120
```

The examples above are for a vehicle traveling at a constant velocity with these wheel sensor characteristics:

- Wheel Circumference = 2 m
- Vehicle Velocity (assumed constant for this example) = 10 m/s
- Ticks Per Revolution = 8
- Cumulative Ticks Per Second =  $(10 \text{ m/s}) \cdot (8 \text{ ticks/rev}) / (2 \text{ m/rev}) = 40$
- Latency between 1PPS and measurement from wheel sensor hardware = 123 ms

| Field | Field Type           | ASCII Value | Binary Value | Description  | Format | Binary Bytes | Binary Offset |
|-------|----------------------|-------------|--------------|--|--------|--------------|---------------|
| 1     | WHEELVELOCITY header | -           | -            | Command header. See <i>Messages</i> on page 25 for more information. | -      | H            | 0             |

| Field | Field Type           | ASCII Value | Binary Value | Description  | Format | Binary Bytes | Binary Offset |
|-------|----------------------|-------------|--------------|--|--------|--------------|---------------|
| 2     | Latency              |             |              | A measure of the latency in the velocity time tag in ms. | Ushort | 2            | H             |
| 3     | Ticks/rev            |             |              | Number of ticks per revolution                           | Ushort | 2            | H+2           |
| 4     | Wheel Velocity       |             |              | Short wheel velocity in ticks/s                          | Ushort | 2            | H+4           |
| 5     | Reserved             |             |              |  | Ushort | 2            | H+6           |
| 6     | Float Wheel Velocity |             |              | Float wheel velocity in ticks/s                          | Float  | 4            | H+8           |
| 7     | Reserved             |             |              |  | Ulong  | 4            | H+12          |
| 8     | Reserved             |             |              |  | Ulong  | 4            | H+16          |
| 9     | Cumulative Ticks/s   |             |              | Cumulative number of ticks/s                             | Ulong  | 4            | H+20          |

## Chapter 5 SPAN Logs

The SPAN specific logs follow the same general logging scheme as normal OEM7 Family logs. They are available in ASCII or binary formats and are defined as being either synchronous or asynchronous. All the logs in this chapter are used only with the SPAN system.

For information on other available logs and output logging, refer to *Logs* on page 391.

One difference from the standard OEM7 Family logs is there are two possible headers for the ASCII and binary versions of the logs. Which header is used for a given log is described in the log definitions in this chapter. The reason for the alternate short headers is that the normal OEM7 binary header is quite long at 28 bytes. This is nearly as long as the data portion of many of the INS logs and creates excess storage and baud rate requirements. Note that the INS related logs contain a time tag within the data block in addition to the time tag in the header. The time tag in the data block should be considered the exact time of applicability of the data. All INS Position, Velocity and Attitude logs can be obtained at a rate of up to 200 Hz. The standard deviation and update logs are available once per second.



Each ASCII log ends with a hexadecimal number preceded by an asterisk and followed by a line termination using the carriage return and line feed characters, for example, **\*1234ABCD[CR][LF]**. This value is a 32-bit CRC of all bytes in the log, excluding the '#' or '%' identifier and the asterisk preceding the four checksum digits. See also *Description of ASCII and Binary Logs with Short Headers* on page 42.

*Table 189: Inertial Solution Status* on page 916 shows the status values included in the INS position, velocity and attitude output logs. If the IMU is connected properly and a good status value is not being received, check the hardware setup to ensure it is properly connected. This situation can be recognized in the RAWIMU data by observing accelerometer and gyro values which are not changing with time.

**Logging Restriction Important Notice**

Logging excessive amounts of high rate data can overload the system. When configuring the output for SPAN, NovAtel recommends that only one high rate (>50Hz) message be configured for output at a time. It is possible to log more than one message at high rates, but doing so could have negative impacts on the system. Also, if logging 100/125/200Hz data, always use the binary format.

For optimal performance, log only one high rate output at a time. These logs could be:

- Raw data for post processing  
RAWIMUXSB ONNEW (100, 125 or 200 Hz depending on IMU)
  - RAWIMU logs are not valid with the ONTIME trigger. The raw IMU observations contained in these logs are sequential changes in velocity and rotation. As such, you can only use them for navigation if they are logged at their full rate.
- Real time INS solution  
INSPVASB ONTIME 0.01 or 0.005 (maximum rate equals the IMU rate)
  - Other possible INS solution logs available at high rates are: INSPOSSB, INSVELSB, INSATTSB



The periods available when using the ONTIME trigger are 0.005 (200 Hz), 0.01 (100 Hz), 0.02 (50 Hz), 0.05, 0.1, 0.2, 0.25, 0.5, 1, and any integer number of seconds.

## 5.1 Logs with INS or GNSS Data

There are several logs in the system designed to output the best available solution as well as many logs that output only a specific solution type (PSR, RTK, INS, etc). The table below lists the logs that can provide either a GNSS solution or an INS solution. Most of these derive from the solution the system picks as the best solution. SPAN systems also have a secondary best solution that derives from the GNSS solution only (**BESTGNSSPOS** log (see page 897) and **BESTGNSSVEL** log (see page 900)). The position output from these logs is at the phase center of the antenna.

| Log     | Log Format | GNSS/INS |
|---------|------------|----------|
| BESTPOS | NovAtel    | YES      |
| BESTVEL | NovAtel    | YES      |
| BESTUTM | NovAtel    | YES      |
| BESTXYZ | NovAtel    | YES      |
| GPGGA   | NMEA       | YES      |
| GPGLL   | NMEA       | YES      |
| GPVTG   | NMEA       | YES      |



## 5.2 BESTGNSSPOS

### *Best GNSS Position*

**Platform: OEM719, OEM729, OEM7500, OEM7700, OEM7720, PwrPak7, HxGN PIM7500**

This log contains the best available GNSS position (without INS) computed by the receiver. In addition, it reports several status indicators, including differential age, which is useful in predicting anomalous behavior brought about by outages in differential corrections. A differential age of 0 indicates that no differential correction was used.

With the system operating in an RTK mode, this log reflects the latest low latency solution for up to 60 seconds after reception of the last base station observations. After this 60 second period, the position reverts to the best solution available and the degradation in accuracy is reflected in the standard deviation fields. If the system is not operating in an RTK mode, pseudo range differential solutions continue for the time specified in the **PSRDIFFTIMEOUT** command (see page 279).



BESTGNSSPOS always outputs positions at the antenna phase center.

**Message ID: 1429**

**Log Type: Synch**

**Recommended Input:**

```
log bestgnssposa ontime 1
```

**ASCII Example:**

```
#BESTGNSSPOSA,COM1,0,92.5,FINESTEERING,1692,332119.000,02000000,8505,4  
3521;SOL_COMPUTED,SINGLE,51.11635530655,-114.03819448382,1064.6283,-  
16.9000,WGS84,1.2612,0.9535,2.7421,"",0.000,0.000,11,11,11,11,0,06,00,  
03*52d3f7c0
```

| Field | Field type         | Data Description  | Format | Binary Bytes | Binary Offset |
|-------|--------------------|---|--------|--------------|---------------|
| 1     | BESTGNSSPOS Header | Log header. See <i>Messages</i> on page 25 for more information.          | -      | H            | 0             |
| 2     | Sol Status         | Solution status, see <i>Table 73: Solution Status</i> on page 419         | Enum   | 4            | H             |
| 3     | Pos Type           | Position type, see <i>Table 74: Position or Velocity Type</i> on page 420 | Enum   | 4            | H+4           |
| 4     | Lat                | Latitude (degrees)  | Double | 8            | H+8           |
| 5     | Lon                | Longitude (degrees)   | Double | 8            | H+16          |

| Field | Field type                  | Data Description   | Format  | Binary Bytes | Binary Offset |
|-------|-----------------------------|--|---------|--------------|---------------|
| 6     | Hgt                         | Height above mean sea level (metres)   | Double  | 8            | H+24          |
| 7     | Undulation                  | Undulation - the relationship between the geoid and the ellipsoid (m) of the chosen datum<br><br><div style="border: 1px solid black; padding: 5px; background-color: #f0f0f0;">  <p>When using a datum other than WGS84, the undulation value also includes the vertical shift due to differences between the datum in use and WGS84.</p> </div> | Float   | 4            | H+32          |
| 8     | Datum ID                    | Datum ID (refer <i>Table 28: Datum Transformation Parameters</i> on page 116)  | Enum    | 4            | H+36          |
| 9     | Lat $\sigma$                | Latitude standard deviation (metres)   | Float   | 4            | H+40          |
| 10    | Lon $\sigma$                | Longitude standard deviation (metres)  | Float   | 4            | H+44          |
| 11    | Hgt $\sigma$                | Height standard deviation (metres)   | Float   | 4            | H+48          |
| 12    | Stn ID                      | Base station ID  | Char[4] | 4            | H+52          |
| 13    | Diff_age                    | Differential age in seconds  | Float   | 4            | H+56          |
| 14    | Sol_age                     | Solution age in seconds  | Float   | 4            | H+60          |
| 15    | #SVs                        | Number of satellites tracked   | Uchar   | 1            | H+64          |
| 16    | #solnSVs                    | Number of satellite solutions used in solution   | Uchar   | 1            | H+65          |
| 17    | #solnL1SVs                  | Number of satellites with L1/E1/B1 signals used in solution  | Uchar   | 1            | H+66          |
| 18    | #solnMultiSVs               | Number of satellites with multi-frequency signals used in solution   | Uchar   | 1            | H+67          |
| 19    | Reserved                    |  | Uchar   | 1            | H+68          |
| 20    | ext sol stat                | Extended solution status (see <i>Table 77: Extended Solution Status</i> on page 423)   | Hex     | 1            | H+69          |
| 21    | Galileo and BeiDou sig mask | Galileo and BeiDou signals used mask (see <i>Table 76: Galileo and BeiDou Signal-Used Mask</i> on page 423)  | Hex     | 1            | H+70          |

| Field | Field type               | Data Description  | Format | Binary Bytes | Binary Offset |
|-------|--------------------------|---|--------|--------------|---------------|
| 22    | GPS and GLONASS sig mask | GPS and GLONASS signals used mask (see <i>Table 75: GPS and GLONASS Signal-Used Mask</i> on page 422) | Hex    | 1            | H+71          |
| 23    | xxxx                     | 32-bit CRC (ASCII and Binary only)  | Hex    | 4            | H+72          |
| 24    | [CR][LF]                 | Sentence terminator (ASCII only)  | -      | -            | -             |

## 5.3 BESTGNSSVEL

### *Best Available GNSS Velocity Data*

**Platform: OEM719, OEM729, OEM7500, OEM7700, OEM7720, PwrPak7, HxGN PIM7500**

This log contains the best available GNSS velocity information (without INS) computed by the receiver. In addition, it reports a velocity status indicator, which is useful to indicate whether or not the corresponding data is valid. The velocity measurements sometimes have a latency associated with them. The time of validity is the time tag in the log minus the latency value.

The velocity is typically computed from the average change in pseudorange over the time interval or the RTK Low Latency filter. As such, it is an average velocity based on the time difference between successive position computations and not an instantaneous velocity at the BESTGNSSVEL time tag. The velocity latency to be subtracted from the time tag is normally half the time between filter updates. Under default operation, the positioning filters are updated at a rate of 2 Hz. This translates into a velocity latency of 0.25 seconds. The latency is reduced by increasing the update rate of the positioning filter used by requesting the BESTGNSSVEL or BESTGNSSPOS messages at a rate higher than 2 Hz. For example, a logging rate of 10 Hz reduces the velocity latency to 0.005 seconds. For integration purposes, the velocity latency should be applied to the record time tag.

A valid solution with a latency of 0.0 indicates the instantaneous Doppler measurement was used to calculate velocity.

**Message ID: 1430**

**Log Type: Synch**

**Recommended Input:**

```
log bestgnssvela ontime 1
```

**ASCII Example:**

```
#BESTGNSSVELA,COM1,0,91.5,FINESTEERING,1692,332217.000,02000000,00b0,43521;SOL_COMPUTED,DOPPLER_VELOCITY,0.150,0.000,0.0168,323.193320,0.0232,0.0*159c13ad
```

| Field | Field type         | Data Description  | Format | Binary Bytes | Binary Offset |
|-------|--------------------|---|--------|--------------|---------------|
| 1     | BESTGNSSVEL Header | Log header. See <i>Messages</i> on page 25 for more information.          | -      | H            | 0             |
| 2     | Sol Status         | Solution status, see <i>Table 73: Solution Status</i> on page 419         | Enum   | 4            | H             |
| 3     | Vel Type           | Velocity type, see <i>Table 74: Position or Velocity Type</i> on page 420 | Enum   | 4            | H+4           |

| Field | Field type | Data Description  | Format | Binary Bytes | Binary Offset |
|-------|------------|---|--------|--------------|---------------|
| 4     | Latency    | A measure of the latency in the velocity time tag in seconds. It should be subtracted from the time to give improved results.                         | Float  | 4            | H+8           |
| 5     | Age        | Differential age  | Float  | 4            | H+12          |
| 6     | Hor Spd    | Horizontal speed over ground, in metres per second  | Double | 8            | H+16          |
| 7     | Trk Gnd    | Actual direction of motion over ground (track over ground) with respect to True North, in degrees   | Double | 8            | H+24          |
| 8     | Vert Spd   | Vertical speed, in metres per second, where positive values indicate increasing altitude (up) and negative values indicate decreasing altitude (down) | Double | 8            | H+32          |
| 9     | Reserved   |   | Float  | 4            | H+40          |
| 10    | xxxx       | 32-bit CRC (ASCII and Binary only)  | Hex    | 4            | H+44          |
| 11    | [CR][LF]   | Sentence terminator (ASCII only)  | -      | -            | -             |

## 5.4 CORRIMUDATA

### *Corrected IMU Measurements*

**Platform: OEM719, OEM729, OEM7500, OEM7700, OEM7720, PwrPak7, HxGN PIM7500**

The CORRIMUDATA log contains the RAWIMU data corrected for gravity, the earth's rotation and estimated sensor errors. The values in this log are incremental values, accumulated over the logging interval of CORRIMUDATA, in units of radians for the attitude rate and m/s for the accelerations. Data output is not in the IMU Body frame, but is automatically rotated into the user configured output frame (configured with the **SETINSROTATION** command (see page 877), default Vehicle frame).



The short header format, CORRIMUDATAS, is recommended, as it is for all high data rate logs.

CORRIMUDATA can be logged with the ONTIME trigger, up to a rate of 200 Hz.



Since the CORRIMUDATA log is synchronous, if you log at a rate less than full data rate of the IMU, the corrected IMU data is accumulated to match the requested time interval. For asynchronous, full rate data, see the **IMURATECORRIMUS** log on page 909.

**Message ID: 812**

**Log Type: Synch**

**Recommended Input:**

```
log corrimudatab ontime 0.01
```

**Example log:**

```
#CORRIMUDATAA,COM1,0,77.5,FINESTEERING,1769,237601.000,02000020,bdba,1
2597;1769,237601.000000000,-
0.000003356,0.000002872,0.000001398,0.000151593,0.000038348,-
0.000078820*1f7eb709
```

| Field | Field Type         | Description  | Format | Binary Bytes | Binary Offset |
|-------|--------------------|--|--------|--------------|---------------|
| 1     | CORRIMUDATA Header | Log header. See <i>Messages</i> on page 25 for more information. | -      | H            | 0             |
| 2     | Week               | GNSS week  | Ulong  | 4            | H+            |
| 3     | Seconds            | GNSS seconds from week start                                     | Double | 8            | H+4           |

| Field | Field Type      | Description   | Format | Binary Bytes | Binary Offset |
|-------|-----------------|---|--------|--------------|---------------|
| 4     | PitchRate       | About x axis rotation (right-handed) (rad/sample)         | Double | 8            | H+12          |
| 5     | RollRate        | About y axis rotation (right-handed) (rad/sample)         | Double | 8            | H+20          |
| 6     | YawRate         | About z axis rotation (right-handed) (rad/sample)         | Double | 8            | H+28          |
| 7     | LateralAcc      | INS Lateral Acceleration (along x axis) (m/s/sample)      | Double | 8            | H+36          |
| 8     | LongitudinalAcc | INS Longitudinal Acceleration (along y axis) (m/s/sample) | Double | 8            | H+44          |
| 9     | VerticalAcc     | INS Vertical Acceleration (along z axis) (m/s/sample)     | Double | 8            | H+52          |
| 10    | xxxx            | 32-bit CRC  | Hex    | 4            | H+56          |
| 11    | [CR][LF]        | Sentence Terminator (ASCII only)                          | -      | -            | -             |

## 5.5 CORRIMUDATAS

### *Short Corrected IMU Measurements*

**Platform: OEM719, OEM729, OEM7500, OEM7700, OEM7720, PwrPak7, HxGN PIM7500**

This log is the short header version of the **CORRIMUDATA** log (see page 902).

**Message ID: 813**

**Log Type: Synch**

**Recommended Input:**

```
log corrimudatasb ontime 0.01
```

**Example log:**

```
%CORRIMUDATASA,1581,341553.000;1581,341552.997500000,-0.000000690,-  
0.000001549,0.000001654,0.000061579,-0.000012645,-0.000029988*770c6232
```

| Field | Field Type          | Description  | Format | Binary Bytes | Binary Offset |
|-------|---------------------|--|--------|--------------|---------------|
| 1     | CORRIMUDATAS Header | Log header. See <i>Messages</i> on page 25 for more information. | -      | H            | 0             |
| 2     | Week                | GNSS week  | Ulong  | 4            | H+            |
| 3     | Seconds             | GNSS seconds from week start                                     | Double | 8            | H+4           |
| 4     | PitchRate           | About x-axis rotation (right-handed) (rad/sample)                | Double | 8            | H+12          |
| 5     | RollRate            | About y-axis rotation (right-handed) (rad/sample)                | Double | 8            | H+20          |
| 6     | YawRate             | About z-axis rotation (right-handed) (rad/sample)                | Double | 8            | H+28          |
| 7     | LateralAcc          | INS Lateral Acceleration (along x-axis) (m/s/sample)             | Double | 8            | H+36          |
| 8     | LongitudinalAcc     | INS Longitudinal Acceleration (along y-axis) (m/s/sample)        | Double | 8            | H+44          |
| 9     | VerticalAcc         | INS Vertical Acceleration (along z-axis) (m/s/sample)            | Double | 8            | H+52          |
| 10    | xxxx                | 32-bit CRC   | Hex    | 4            | H+56          |
| 11    | [CR][LF]            | Sentence Terminator (ASCII only)                                 | -      | -            | -             |



## 5.6 DELAYEDHEAVE

### *Delayed Heave Filter*

**Platform: OEM719, OEM729, OEM7500, OEM7700, OEM7720, PwrPak7, HxGN PIM7500**

This log contains the value of the delayed heave filter. The delayed heave value differs from the heave value in that delayed heave uses forward and backward smoothing, while heave uses backward smoothing only.

The heave filter must be enabled using the **HEAVEFILTER** command (see page 851) before this log is available.



The **DELAYEDHEAVE** log is output with default values and the current time stamp when the HEAVEFILTER is DISABLED.

When the HEAVEFILTER is ENABLED, the **DELAYEDHEAVE** log will not be output until the heave window conditions (see the **SETHEAVEWINDOW** command on page 870) have been met.

**Message ID: 1709**

**Log Type: Synch**

**Recommended Input:**

```
log delayedheave ontime 0.1
```

**ASCII example:**

```
#DELAYEDHEAVEA, COM1, 0, 72.0, FINESTEERING, 1769, 237598.000, 02000020, 27a3, 12597;0.000080643, 0.086274510*85cdb46d
```

| Field | Field Type          | Description  | Format | Binary Bytes | Binary Offset |
|-------|---------------------|--|--------|--------------|---------------|
| 1     | DELAYEDHEAVE Header | Log header. See <i>Messages</i> on page 25 for more information. | -      | H            | 0             |
| 2     | Delayed Heave       | Delayed heave value  | Double | 8            | H             |
| 3     | Std. Dev.           | Standard deviation of the delayed heave value                    | Double | 8            | H+8           |
| 4     | xxxx                | 32-bit CRC (ASCII and Binary only)                               | Hex    | 4            | H+16          |
| 5     | [CR][LF]            | Sentence Terminator (ASCII only)                                 | -      | -            | -             |

## 5.7 GIMBALLEDPVA

### *Display Gimballed Position*

**Platform: OEM719, OEM729, OEM7500, OEM7700, OEM7720, PwrPak7, HxGN PIM7500**

Use the GIMBALLEDPVA log to view the re-calculated position, velocity and attitude of the gimbal null position whenever a new **INPUTGIMBALANGLE** command (see page 852) is received.

**Message ID: 1321**

**Log Type: Asynch**

**Recommended Input:**

```
log gimballedpvaa onnew
```

**ASCII Example:**

```
#GIMBALLEDPVAA,COM1,0,93.5,FINESTEERING,1635,320568.514,02000000,0000,407;1635,320568.514000000,51.116376614,-114.038259915,1046.112025828,-0.000291756,-0.000578067,0.030324466,-0.243093917,-0.127718304,19.495023227,INS_ALIGNMENT_COMPLETE*32fbb61b
```

| Field | Field Type          | Description   | Format | Binary Bytes | Binary Offset |
|-------|---------------------|---|--------|--------------|---------------|
| 1     | GIMBALLEDPVA Header | Log header. See <i>Messages</i> on page 25 for more information.    | -      | H            | 0             |
| 2     | Week                | GPS week  | Ulong  | 4            | H             |
| 3     | Seconds             | Seconds from week start   | Double | 8            | H+4           |
| 4     | Latitude            | WGS84 latitude in degrees   | Double | 8            | H+12          |
| 5     | Longitude           | WGS84 longitude in degrees  | Double | 8            | H+20          |
| 6     | Height              | WGS84 ellipsoidal height  | Double | 8            | H+28          |
| 7     | North Velocity      | Velocity in a northerly direction                                   | Double | 8            | H+36          |
| 8     | East Velocity       | Velocity in an easterly direction                                   | Double | 8            | H+44          |
| 9     | Up Velocity         | Velocity in an upward direction                                     | Double | 8            | H+52          |
| 10    | Roll                | Right-handed rotation from local level around the y-axis in degrees | Double | 8            | H+60          |
| 11    | Pitch               | Right-handed rotation from local level around the x-axis in degrees | Double | 8            | H+68          |
| 12    | Azimuth             | Right-handed rotation from local level around the z-axis in degrees | Double | 8            | H+76          |

| <b>Field</b> | <b>Field Type</b> | <b>Description</b>   | <b>Format</b> | <b>Binary Bytes</b> | <b>Binary Offset</b> |
|--------------|-------------------|--|---------------|---------------------|----------------------|
| 13           | Status            | INS status, see <i>Table 189: Inertial Solution Status</i> on page 916 | Enum          | 4                   | H+84                 |
| 14           | xxxx              | 32-bit CRC   | Hex           | 4                   | H+88                 |
| 15           | [CR][LF]          | Sentence Terminator (ASCII only)                                       | -             | -                   | -                    |

## 5.8 HEAVE

### *Heave Filter Log*

**Platform: OEM719, OEM729, OEM7500, OEM7700, OEM7720, PwrPak7, HxGN PIM7500**

This log provides vessel heave computed by the integrated heave filter. Refer also to information in the **SETHEAWEWINDOW** command on page 870. This log is asynchronous, but is available at approximately 10 Hz.



You must have an inertial solution to use this log.

The heave filter must be enabled using the **HEAVEFILTER** command (see page 851), before this log is available.

**Message ID: 1382**

**Log Type: Asynch**

**Recommended Input:**

```
log heavea onnew
```

**Example:**

```
#HEAVEA,USB1,0,38.5,FINESTEERING,1630,232064.599,02000000,a759,6696;1630,232064.589885392,0.086825199*93392cb4
```

| Field | Field Type        | Description  | Format | Binary Bytes | Binary Offset |
|-------|-------------------|--|--------|--------------|---------------|
| 1     | HEAVE Header      | Log header. See <i>Messages</i> on page 25 for more information. | -      | H            | 0             |
| 2     | Week              | GNSS Week  | Ulong  | 4            | H             |
| 3     | Seconds into Week | Seconds from week start  | Double | 8            | H+4           |
| 4     | Heave             | Instantaneous heave in metres                                    | Double | 8            | H+12          |
| 5     | xxxx              | 32-bit CRC (ASCII, Binary and Short Binary only)                 | Hex    | 4            | H+20          |
| 6     | [CR][LF]          | Sentence Terminator (ASCII Only)                                 | -      | -            | -             |

## 5.9 IMURATECORRIMUS

### *Asynchronous Corrected IMU Data*

**Platform: OEM719, OEM729, OEM7500, OEM7700, OEM7720, PwrPak7, HxGN PIM7500**

This log provides the same information as the **CORRIMUDATAS** log (see page 904), but is available asynchronously at the full rate of the IMU.



Using this log consumes significant system resources and should only be used by experienced users.

However, using this log consumes less resources than logging the synchronous CORRIMUDATAS log at the same rate.

To use this log, asynchronous logging must be enabled. See the **ASYNCHINSLOGGING** command on page 844.

**Message ID: 1362**

**Log Type: Asynch**

**Recommended Input:**

```
log imuratecorrimus
```

**Example log:**

```
%IMURATECORRIMUSA,1581,341553.000;1581,341552.997500000,-0.000000690,-0.000001549,0.000001654,0.000061579,-0.000012645,-0.000029988*770c6232
```

| Field | Field Type             | Description  | Format | Binary Bytes | Binary Offset |
|-------|------------------------|--|--------|--------------|---------------|
| 1     | IMURATECORRIMUS Header | Log header. See <i>Messages</i> on page 25 for more information. | -      | H            | 0             |
| 2     | Week                   | GNSS week  | Ulong  | 4            | H+            |
| 3     | Seconds                | GNSS seconds from week start                                     | Double | 8            | H+4           |
| 4     | PitchRate              | About x axis rotation (rad/sample)                               | Double | 8            | H+12          |
| 5     | RollRate               | About y axis rotation (rad/sample)                               | Double | 8            | H+20          |
| 6     | YawRate                | About z axis rotation (right-handed) (rad/sample)                | Double | 8            | H+28          |
| 7     | LateralAcc             | INS Lateral Acceleration (along x-axis) (m/s/sample)             | Double | 8            | H+36          |

---

| <b>Field</b> | <b>Field Type</b> | <b>Description</b>  | <b>Format</b> | <b>Binary Bytes</b> | <b>Binary Offset</b> |
|--------------|-------------------|---|---------------|---------------------|----------------------|
| 8            | LongitudinalAcc   | INS Longitudinal Acceleration (along y-axis) (m/s/sample) | Double        | 8                   | H+44                 |
| 9            | VerticalAcc       | INS Vertical Acceleration (along z-axis)(m/s/sample)      | Double        | 8                   | H+52                 |
| 10           | xxxx              | 32-bit CRC  | Hex           | 4                   | H+56                 |
| 11           | [CR][LF]          | Sentence Terminator (ASCII only)                          | -             | -                   | -                    |

## 5.10 IMURATEPVA

### *Asynchronous INS Position, Velocity and Attitude*

This log provides the same information as the **INSPVA** log (see page 936), but is available asynchronously at the full rate of the IMU.



Using this log consumes significant system resources and should only be used by experienced users.

However, using this log consumes less resources than logging the synchronous INSPVA log at the same rate.

To use this log, asynchronous logging must be enabled. See the **ASYNCHINSLOGGING** command on page 844.

**Message ID: 1778**

**Log Type: Asynch**

**Recommended Input:**

```
log imuratepvaa onnew
```

**ASCII Example:**

```
#IMURATEPVAA,COM1,0,57.0,FINESTEERING,1802,320345.180,02000000,9b1f,12
987;1802,320345.180000030,51.11695246671,-114.03897779953,1047.6905,-
0.2284,0.0076,0.2227,0.160588332,-0.039823409,269.988184416,INS_
ALIGNMENT_COMPLETE*f60016a6
```

| Field | Field Type        | Description   | Format | Binary Bytes | Binary Offset |
|-------|-------------------|---|--------|--------------|---------------|
| 1     | IMURATEPVA Header | Log header. See <i>Messages</i> on page 25 for more information.                    | -      | H            | 0             |
| 2     | Week              | GNSS Week   | Ulong  | 4            | H             |
| 3     | Seconds           | Seconds from week start   | Double | 8            | H+4           |
| 4     | Latitude          | Latitude (WGS84) [degrees]  | Double | 8            | H+12          |
| 5     | Longitude         | Longitude (WGS84) [degrees]   | Double | 8            | H+20          |
| 6     | Height            | Ellipsoidal Height (WGS84) [m]  | Double | 8            | H+28          |
| 7     | North Velocity    | Velocity in a northerly direction (a -ve value implies a southerly direction) [m/s] | Double | 8            | H+36          |
| 8     | East Velocity     | Velocity in an easterly direction (a -ve value implies a westerly direction) [m/s]  | Double | 8            | H+44          |

| Field | Field Type  | Description  | Format | Binary Bytes | Binary Offset |
|-------|-------------|--|--------|--------------|---------------|
| 9     | Up Velocity | Velocity in an up direction [m/s]  | Double | 8            | H+52          |
| 10    | Roll        | Right-handed rotation from local level around y-axis in degrees  | Double | 8            | H+60          |
| 11    | Pitch       | Right-handed rotation from local level around x-axis in degrees  | Double | 8            | H+68          |
| 12    | Azimuth     | Left-handed rotation around z-axis in degrees clockwise from North<br>This is the inertial azimuth calculated from the IMU gyros and the SPAN filters. | Double | 8            | H+76          |
| 13    | Status      | INS Status, see <i>Table 189: Inertial Solution Status</i> on page 916   | Enum   | 4            | H+84          |
| 14    | xxxx        | 32-bit CRC   | Hex    | 4            | H+88          |
| 15    | [CR][LF]    | Sentence Terminator (ASCII only)   | -      | -            | -             |



## 5.11 IMURATEPVAS

### *Asynchronous INS Position, Velocity and Attitude*

**Platform: OEM719, OEM729, OEM7500, OEM7700, OEM7720, PwrPak7, HxGN PIM7500**

This log provides the same information as the **INSPVAS** log (see page 938), but is available asynchronously at the full rate of the IMU.



Using this log consumes significant system resources and should only be used by experienced users.

However, using this log consumes less resources than logging the synchronous INSPVAS log at the same rate.

To use this log, asynchronous logging must be enabled. See the **ASYNCHINSLOGGING** command on page 844.

**Message ID: 1305**

**Log Type: Asynch**

**Recommended Input:**

```
log imuratepvas
```

**ASCII Example:**

```
%IMURATEPVASA,1264,144059.000;1264,144059.002135700,51.116680071,-
114.037929194,515.286704183,277.896368884,84.915188605,-
8.488207941,0.759619515,-2.892414901,6.179554750,INS_ALIGNMENT_
COMPLETE*855d6f76
```

| Field | Field Type         | Description   | Format | Binary Bytes | Binary Offset |
|-------|--------------------|---|--------|--------------|---------------|
| 1     | IMURATEPVAS Header | Log header. See <i>Messages</i> on page 25 for more information.                    | -      | H            | 0             |
| 2     | Week               | GNSS Week   | Ulong  | 4            | H             |
| 3     | Seconds            | Seconds from week start   | Double | 8            | H+4           |
| 4     | Latitude           | Latitude (WGS84)  | Double | 8            | H+12          |
| 5     | Longitude          | Longitude (WGS84)   | Double | 8            | H+20          |
| 6     | Height             | Ellipsoidal Height (WGS84) [m]  | Double | 8            | H+28          |
| 7     | North Velocity     | Velocity in a northerly direction (a -ve value implies a southerly direction) [m/s] | Double | 8            | H+36          |

| Field | Field Type    | Description  | Format | Binary Bytes | Binary Offset |
|-------|---------------|--|--------|--------------|---------------|
| 8     | East Velocity | Velocity in an easterly direction (a -ve value implies a westerly direction) [m/s] | Double | 8            | H+44          |
| 9     | Up Velocity   | Velocity in an up direction [m/s]  | Double | 8            | H+52          |
| 10    | Roll          | Right-handed rotation from local level around y-axis in degrees                    | Double | 8            | H+60          |
| 11    | Pitch         | Right-handed rotation from local level around x-axis in degrees                    | Double | 8            | H+68          |
| 12    | Azimuth       | Left-handed rotation around z-axis in degrees clockwise from North                 | Double | 8            | H+76          |
| 13    | Status        | INS Status, see <i>Table 189: Inertial Solution Status</i> on page 916             | Enum   | 4            | H+84          |
| 14    | xxxx          | 32-bit CRC   | Hex    | 4            | H+88          |
| 15    | [CR][LF]      | Sentence Terminator (ASCII only)   | -      | -            | -             |

## 5.12 INSATT

### *INS Attitude*

**Platform: OEM719, OEM729, OEM7500, OEM7700, OEM7720, PwrPak7, HxGN PIM7500**

This log contains the most recent attitude measurements computed by the SPAN filter. This attitude definition may not correspond to other definitions of the terms pitch, roll and azimuth. By default, the output attitude is with respect to the vehicle frame. If the attitude output is desired with respect to another frame of reference, use the **SETINSROTATION USER** command (see the **SETINSROTATION** command on page 877) to configure the user output frame offset rotation.

**Message ID: 263**

**Log Type: Synch**

**Recommended Input:**

```
log insatta ontime 1
```

**ASCII Example:**

```
#INSATTA,USB2,0,14.5,FINESTEERING,1541,487970.000,02040000,5b35,37343;  
1541,487970.000549050,1.876133508,-4.053672765,328.401460897,INS_  
SOLUTION_GOOD*ce4ac533
```

| Field | Field Type        | Description   | Format | Binary Bytes | Binary Offset |
|-------|-------------------|---|--------|--------------|---------------|
| 1     | INSATT Header     | Log header. See <i>Messages</i> on page 25 for more information.  | -      | H            | 0             |
| 2     | Week              | GNSS Week   | Ulong  | 4            | H             |
| 3     | Seconds into Week | Seconds from week start   | Double | 8            | H+4           |
| 4     | Roll              | Right-handed rotation from local level around y-axis in degrees.  | Double | 8            | H+12          |
| 5     | Pitch             | Right-handed rotation from local level around x-axis in degrees.  | Double | 8            | H+20          |
| 6     | Azimuth           | Left-handed rotation around z-axis in degrees clockwise from North.<br>This is the inertial azimuth calculated from the IMU gyros and the SPAN filters. | Double | 8            | H+28          |
| 7     | Status            | INS status, see <i>Table 189: Inertial Solution Status</i> on the next page.  | Enum   |              | H+36          |

| Field | Field Type | Description                                      | Format | Binary Bytes | Binary Offset |
|-------|------------|--|--------|--------------|---------------|
| 8     | xxxx       | 32-bit CRC (ASCII, Binary and Short Binary only) | Hex    |              | H+40          |
| 9     | [CR][LF]   | Sentence terminator (ASCII only)                 | -      | -            | -             |

**Table 189: Inertial Solution Status**

| Binary | ASCII                   | Description  |
|--------|-------------------------|--|
| 0      | INS_INACTIVE            | IMU logs are present, but the alignment routine has not started; INS is inactive.  |
| 1      | INS_ALIGNING            | INS is in alignment mode.  |
| 2      | INS_HIGH_VARIANCE       | The INS solution is in navigation mode but the azimuth solution uncertainty has exceeded the threshold. The default threshold is 2 degrees for most IMUs. <sup>1</sup> The solution is still valid but you should monitor the solution uncertainty in the <b>INSSTDEV</b> log (see page 949). You may encounter this state during times when the GNSS, used to aid the INS, is absent. |
| 3      | INS_SOLUTION_GOOD       | The INS filter is in navigation mode and the INS solution is good.   |
| 6      | INS_SOLUTION_FREE       | The INS filter is in navigation mode and the GNSS solution is suspected to be in error.<br>This may be due to multipath or limited satellite visibility. The inertial filter has rejected the GNSS position and is waiting for the solution quality to improve.  |
| 7      | INS_ALIGNMENT_COMPLETE  | The INS filter is in navigation mode, but not enough vehicle dynamics have been experienced for the system to be within specifications.  |
| 8      | DETERMINING_ORIENTATION | INS is determining the IMU axis aligned with gravity.  |
| 9      | WAITING_INITIALPOS      | The INS filter has determined the IMU orientation and is awaiting an initial position estimate to begin the alignment process.   |
| 10     | WAITING_AZIMUTH         | The INS filter has orientation, initial biases, initial position and valid roll/pitch estimated. Will not proceed until initial azimuth is entered.  |

<sup>1</sup>This value is configured using the **INSTHRESHOLDS** command on page 863.

| <b>Binary</b> | <b>ASCII</b>            | <b>Description</b>  |
|---------------|-------------------------|---|
| 11            | INITIALIZING_<br>BIASES | The INS filter is estimating initial biases during the first 10 seconds of stationary data. |
| 12            | MOTION_<br>DETECT       | The INS filter has not completely aligned, but has detected motion.                         |

## 5.13 INSATTQS

### *Short INS Quaternion Attitude*

**Platform: OEM719, OEM729, OEM7500, OEM7700, OEM7720, PwrPak7, HxGN PIM7500**

This log contains the attitude from the INSATT log, but the rotation from local level is given as a Quaternion rather than Euler Angles. The quaternion takes the form:

$$\mathbf{q}_t^b = [w \ x \ y \ z]^T$$

The element  $w$  is the rotational component, defining the magnitude of the rotation to be performed. The elements  $x$ ,  $y$ , and  $z$  are the vector portion of the rotation, which define the axis about which the rotation is to be performed.

If  $\theta$  is the rotational angle, and the axis of rotation is defined by the vector  $\mathbf{v} = [v_x \ v_y \ v_z]^T$ , then the elements of the quaternion can be written as:

$$w = \cos \frac{\theta}{2}$$

$$x = v_x \sin \frac{\theta}{2}$$

$$y = v_y \sin \frac{\theta}{2}$$

$$z = v_z \sin \frac{\theta}{2}$$

**Message ID: 2118**

**Log Type: Synch**

**Recommended Input:**

```
log insattqsa ontime 1
```

**ASCII Example:**

```
%INSATTQSA,1943,425090.000;1943,425090.000000000,0.706276782,0.001974400,-0.001083571,-0.707932225,INS_ALIGNMENT_COMPLETE*552d93f0
```

| Field | Field Type        | Description  | Format | Binary Bytes | Binary Offset |
|-------|-------------------|--|--------|--------------|---------------|
| 1     | INSATTQS Header   | Log header. See <i>Messages</i> on page 25 for more information. | -      | H            | 0             |
| 2     | Week              | GNSS Week  | Ulong  | 4            | H             |
| 3     | Seconds into Week | Seconds from week start  | Double | 8            | H+4           |

| Field | Field Type   | Description  | Format | Binary Bytes | Binary Offset |
|-------|--------------|--|--------|--------------|---------------|
| 4     | Quaternion w | Quaternion rotation from local level, w component                      | Double | 8            | H+12          |
| 5     | Quaternion x | Quaternion rotation from local level, x component                      | Double | 8            | H+20          |
| 6     | Quaternion y | Quaternion rotation from local level, y component                      | Double | 8            | H+28          |
| 7     | Quaternion z | Quaternion rotation from local level, z component                      | Double | 8            | H+36          |
| 8     | Status       | INS status, see <i>Table 189: Inertial Solution Status</i> on page 916 | Enum   | 4            | H+44          |
| 9     | xxxx         | 32-bit CRC (ASCII, Binary and Short Binary only)                       | Hex    | 4            | H+48          |
| 10    | [CR][LF]     | Sentence Terminator (ASCII only)                                       | -      | -            | -             |

## 5.14 INSATTS

### *Short INS Attitude*

**Platform: OEM719, OEM729, OEM7500, OEM7700, OEM7720, PwrPak7, HxGN PIM7500**

This log is the short header version of the **INSATT** log (see page 915).

**Message ID: 319**

**Log Type: Synch**

**Recommended Input:**

```
log insattsa ontime 1
```

**ASCII Example:**

```
%INSATTSA,1541,487975.000;1541,487975.000549050,2.755452422,-  
4.127365126,323.289778434,INS_SOLUTION_GOOD*ba08754f
```

| Field | Field Type        | Description  | Format | Binary Bytes | Binary Offset |
|-------|-------------------|--|--------|--------------|---------------|
| 1     | INSATTS Header    | Log header. See <i>Messages</i> on page 25 for more information.   | -      | H            | 0             |
| 2     | Week              | GNSS Week  | Ulong  | 4            | H             |
| 3     | Seconds into Week | Seconds from week start  | Double | 8            | H+4           |
| 4     | Roll              | Right-handed rotation from local level around y-axis in degrees  | Double | 8            | H+12          |
| 5     | Pitch             | Right-handed rotation from local level around x-axis in degrees  | Double | 8            | H+20          |
| 6     | Azimuth           | Left-handed rotation around z-axis in degrees clockwise from North<br>This is the inertial azimuth calculated from the IMU gyros and the SPAN filters. | Double | 8            | H+28          |
| 7     | Status            | INS status, see <i>Table 189: Inertial Solution Status</i> on page 916   | Enum   | 4            | H+36          |
| 8     | xxxx              | 32-bit CRC (ASCII, Binary and Short Binary only)   | Hex    | 4            | H+40          |
| 9     | [CR][LF]          | Sentence terminator (ASCII only)   | -      | -            | -             |



## 5.15 INSATTX

### *Inertial Attitude – Extended*

**Platform: OEM719, OEM729, OEM7500, OEM7700, OEM7720, PwrPak7, HxGN PIM7500**

This log includes the information from the **INSATT** log (see page 915), as well as information about the attitude standard deviation. The position type and solution status fields indicate whether or not the corresponding data is valid.



The INSATTX log is a large log and is not recommend for high rate logging. If you want to use high rate logging, log the **INSATTS** log at a high rate and the **INSSTDEVS** log ontime 1.

**Message ID: 1457**

**Log Type: Synch**

**Recommended Input:**

```
log insattxa ontime 1
```

**ASCII Example:**

```
#INSATTXA,COM1,0,81.0,FINESTEERING,1690,494542.000,02000040,5d25,43441
;INS_ALIGNMENT_COMPLETE,INS_PSRSP,1.137798832,-
0.163068414,135.754208544,0.017797431,0.017861038,3.168394804,4,0*f944
b004
```

| Field | Field Type     | Description  | Format | Binary Bytes | Binary Offset |
|-------|----------------|--|--------|--------------|---------------|
| 1     | INSATTX Header | Log header. See <i>Messages</i> on page 25 for more information.   |        | H            | 0             |
| 2     | INS Status     | Solution status<br>See <i>Table 189: Inertial Solution Status</i> on page 916  | Enum   | 4            | H             |
| 3     | Pos Type       | Position type<br>See <i>Table 74: Position or Velocity Type</i> on page 420  | Enum   | 4            | H+4           |
| 4     | Roll           | Roll in Local Level (degrees)  | Double | 8            | H+8           |
| 5     | Pitch          | Pitch in Local Level (degrees)   | Double | 8            | H+16          |
| 6     | Azimuth        | Azimuth in Local Level (degrees)<br>This is the inertial azimuth calculated from the IMU gyros and the SPAN filters. | Double | 8            | H+24          |

| Field | Field Type        | Description  | Format | Binary Bytes | Binary Offset |
|-------|-------------------|--|--------|--------------|---------------|
| 7     | Roll $\sigma$     | Roll standard deviation (degrees)  | Float  | 4            | H+32          |
| 8     | Pitch $\sigma$    | Pitch standard deviation (degrees)   | Float  | 4            | H+36          |
| 9     | Azimuth $\sigma$  | Azimuth standard deviation (degrees)   | Float  | 4            | H+40          |
| 10    | Ext sol stat      | Extended solution status<br>See <i>Table 190: Extended Solution Status</i> below | Hex    | 4            | H+44          |
| 11    | Time Since Update | Elapsed time since the last ZUPT or position update (seconds)                    | Ushort | 2            | H+48          |
| 11    | xxxx              | 32-bit CRC (ASCII and Binary only)   | Hex    | 4            | H+50          |
| 12    | [CR][LF]          | Sentence terminator (ASCII only)   | -      | -            | -             |

**Table 190: Extended Solution Status**

| Nibble | Bit | Mask       | Description                   | Range Value                        |
|--------|-----|------------|-------------------------------|------------------------------------|
| N0     | 0   | 0x00000001 | Position update               | 0 = Unused<br>1 = Used             |
|        | 1   | 0x00000002 | Phase update                  | 0 = Unused<br>1 = Used             |
|        | 2   | 0x00000004 | Zero velocity update          | 0 = Unused<br>1 = Used             |
|        | 3   | 0x00000008 | Wheel sensor update           | 0 = Unused<br>1 = Used             |
| N1     | 4   | 0x00000010 | ALIGN (heading) update        | 0 = Unused<br>1 = Used             |
|        | 5   | 0x00000020 | External position update      | 0 = Unused<br>1 = Used             |
|        | 6   | 0x00000040 | INS solution convergence flag | 0 = Not converged<br>1 = Converged |
|        | 7   | 0x00000080 | Doppler update                | 0 = Unused<br>1 = Used             |

| Nibble | Bit | Mask       | Description                | Range Value                                  |
|--------|-----|------------|----------------------------|--|
| N2     | 8   | 0x00000100 | Pseudorange update         | 0 = Unused<br>1 = Used                       |
|        | 9   | 0x00000200 | Velocity update            | 0 = Unused<br>1 = Used                       |
|        | 10  | 0x00000400 | Reserved                   |  |
|        | 11  | 0x00000800 | Dead reckoning update      | 0 = Unused<br>1 = Used                       |
| N3     | 12  | 0x00001000 | Phase wind up update       | 0 = Unused<br>1 = Used                       |
|        | 13  | 0x00002000 | Course over ground update  | 0 = Unused<br>1 = Used                       |
|        | 14  | 0x00004000 | External velocity update   | 0 = Unused<br>1 = Used                       |
|        | 15  | 0x00008000 | External attitude update   | 0 = Unused<br>1 = Used                       |
| N4     | 16  | 0x00010000 | External heading update    | 0 = Unused<br>1 = Used                       |
|        | 17  | 0x00020000 | External height update     | 0 = Unused<br>1 = Used                       |
|        | 18  | 0x00040000 | Reserved                   |  |
|        | 19  | 0x00080000 | Reserved                   |  |
| N5     | 20  | 0x00100000 | Rover position update      | 0 = Unused<br>1 = Used                       |
|        | 21  | 0x00200000 | Rover position update type | 0 = Non-RTK update<br>1 = RTK integer update |
|        | 22  | 0x00400000 | Reserved                   |  |
|        | 23  | 0x00800000 | Reserved                   |  |

| Nibble | Bit | Mask       | Description                  | Range Value   |
|--------|-----|------------|------------------------------|---|
| N6     | 24  | 0x01000000 | Turn on biases estimated     | 0 = Static turn-on biases not estimated (starting from zero)<br>1 = Static turn-on biases estimated |
|        | 25  | 0x02000000 | Alignment direction verified | 0 = Not verified<br>1 = Verified  |
|        | 26  | 0x04000000 | Alignment Indication 1       | 0 = Not set, 1 = Set<br>Refer to <i>Table 191: Alignment Indication</i> below                       |
|        | 27  | 0x08000000 | Alignment Indication 2       | 0 = Not set, 1 = Set<br>Refer to <i>Table 191: Alignment Indication</i> below                       |
| N7     | 28  | 0x10000000 | Alignment Indication 3       | 0 = Not set, 1 = Set<br>Refer to <i>Table 191: Alignment Indication</i> below                       |
|        | 29  | 0x20000000 | NVM Seed Indication 1        | 0 = Not set, 1 = Set<br>Refer to <i>Table 192: NVM Seed Indication</i> on the next page             |
|        | 30  | 0x40000000 | NVM Seed Indication 2        | 0 = Not set, 1 = Set<br>Refer to <i>Table 192: NVM Seed Indication</i> on the next page             |
|        | 31  | 0x80000000 | NVM Seed Indication 3        | 0 = Not set, 1 = Set<br>Refer to <i>Table 192: NVM Seed Indication</i> on the next page             |

**Table 191: Alignment Indication**

| Bits 26-28 Values | Hex Value | Completed Alignment Type |
|-------------------|-----------|--------------------------|
| 000               | 0x00      | Incomplete Alignment     |
| 001               | 0x01      | Static                   |
| 010               | 0x02      | Kinematic                |
| 011               | 0x03      | Dual Antenna             |
| 100               | 0x04      | User Command             |
| 101               | 0x05      | NVM Seed                 |

**Table 192: NVM Seed Indication**

| <b>Bits 29-31 Values</b> | <b>Hex Value</b> | <b>NVM Seed Type</b>                           |
|--------------------------|------------------|--|
| 000                      | 0x00             | NVM Seed inactive                              |
| 001                      | 0x01             | Seed stored in NVM is invalid                  |
| 010                      | 0x02             | NVM Seed failed validation check               |
| 011                      | 0x03             | NVM Seed is pending validation (awaiting GNSS) |
| 100                      | 0x04             | NVM Seed injected                              |

## 5.16 INSCALSTATUS

### *Offset calibration status*

**Platform: OEM719, OEM729, OEM7500, OEM7700, OEM7720, PwrPak7, HxGN PIM7500**

This log reports the status and estimated values of the currently running offset calibration.

**Message ID: 1961**

**Log Type: Asynch**

**Abbreviated ASCII Syntax:**

```
log inscalstatus onchanged
```

**ASCII Example:**

```
#INSCALSTATUSA,COM1,0,80.0,FINESTEERING,1880,317815.012,02000000,a4f2,32768;RBV,0.0000,-180.0000,-90.0000,45.0000,45.0000,45.0000,INS_CONVERGING,1*e0b3152d
```

| Field | Field Type                   | Description   | Binary Format | Binary Bytes | Binary Offset |
|-------|------------------------------|---|---------------|--------------|---------------|
| 1     | INSCALSTATUS header          | Log header. See <i>Messages</i> on page 25 for more information.                                  | -             | H            | 0             |
| 2     | Offset Type                  | Type of offset (see <i>Table 193: Offset Type</i> on the next page).                              | Enum          | 4            | H             |
| 3     | X axis offset                | IMU body frame X-axis offset (m/degrees).   | Float         | 4            | H+4           |
| 4     | Y axis offset                | IMU body frame Y-axis offset (m/degrees).   | Float         | 4            | H+8           |
| 5     | Z axis offset                | IMU body frame Z-axis offset (m/degrees).   | Float         | 4            | H+12          |
| 6     | X uncertainty                | IMU body frame X-axis offset uncertainty (m/degrees).   | Float         | 4            | H+16          |
| 7     | Y uncertainty                | IMU body frame Y-axis offset uncertainty (m/degrees).   | Float         | 4            | H+20          |
| 8     | Z uncertainty                | IMU body frame Z-axis offset uncertainty (m/degrees).   | Float         | 4            | H+24          |
| 9     | Source Status                | Source from which offset values originate (see <i>Table 194: Source Status</i> on the next page). | Enum          | 4            | H+28          |
| 10    | Multi-line Calibration Count | Counter for number of completed calibrations cumulatively averaged.                               | Ulong         | 4            | H+32          |

| Field | Field Type | Description                         | Binary Format | Binary Bytes | Binary Offset |
|-------|------------|-------------------------------------|---------------|--------------|---------------|
| 11    | xxxx       | 32-bit CRC (ASCII and Binary only). | Hex           | 4            | H+36          |
| 12    | [CR][LF]   | Sentence terminator (ASCII only).   | -             | -            | -             |



Units for the axis offset and uncertainty values (fields 3-8) are in metres for translational offset components and degrees for rotational offset components.

**Table 193: Offset Type**

| Binary | ASCII | Description                      |
|--------|-------|----------------------------------|
| 1      | ANT1  | Primary IMU to antenna lever arm |
| 8      | ALIGN | Align offset                     |
| 11     | RBV   | IMU body to vehicle offset       |

**Table 194: Source Status**

| Binary | ASCII              | Description   |
|--------|--------------------|---|
| 1      | FROM_NVM           | Offset values originate from saved parameters in NVM  |
| 2      | CALIBRATING        | Offset values originate from a currently running calibration process  |
| 3      | CALIBRATED         | Offset values originate from a completed calibration process  |
| 4      | FROM_COMMAND       | Offset values originate from a user command   |
| 5      | RESET              | Offset values originate from a system reset   |
| 6      | FROM_DUAL_ANT      | Offset values originate from a dual antenna Align solution  |
| 7      | INS_CONVERGING     | Offset values originate from initial input values. Calibration process on hold until INS solution is converged.                 |
| 8      | INSUFFICIENT_SPEED | Offset values originate from a currently running calibration process. Further estimation on hold due to insufficient speed.     |
| 9      | HIGH_ROTATION      | Offset values originate from a currently running calibration process. Further estimation on hold due to high vehicle rotations. |

## 5.17 INSCONFIG

**Determine required settings for post-processing or system analysis**

**Platform: OEM719, OEM729, OEM7500, OEM7700, OEM7720, PwrPak7, HxGN PIM7500**

This log is the single message required to determine all required settings for post-processing or system analysis. This log is asynchronous and published for any change to the included fields. It is intended to be recorded occasionally though it could be updated frequently at system startup.

**Message ID: 1945**

**Log Type: Polled**

**Recommended Input:**

```
log insconfig onchanged
```

**ASCII Example:**

```
#INSCONFIGA,COM1,0,71.0,COARSESTEERING,1931,517331.006,02400000,6d7a,
32768;EPSON_G320,6,50,20,DEFAULT,00ffd1bf,AUTOMATIC,ROVER,FALSE,
00000000,0,0,0,0,0,0,0,0,0,1,ANT1,IMUBODY,0.0540,0.0699,-0.0346,0.0200,
0.0200,0.0200,FROM_NVM,1,RBV,IMUBODY,180.0000,0.0000,90.0000,5.0000,
5.0000,5.0000,FROM_COMMAND*b1233ac4
```

| Field | Field Type                 | Description   | Binary Format | Binary Bytes | Binary Offset |
|-------|----------------------------|---|---------------|--------------|---------------|
| 1     | INSCONFIG Header           | Command header. See <i>Messages</i> on page 25 for more information.  | -             | H            | 0             |
| 2     | IMU Type                   | IMU type  | Enum          | 4            | H             |
| 3     | Mapping                    | Mapping / Orientation   | Uchar         | 1            | H+4           |
| 4     | Initial Alignment Velocity | Minimum Alignment Velocity entered by the user.<br><b>Note:</b> Velocity (m/s) is scaled by 10 for 10cm/s precision | Uchar         | 1            | H+5           |
| 5     | Heave Window               | Length of the heave window in seconds (if set)  | Ushort        | 2            | H+6           |
| 6     | Profile                    | Profile setting (see the <b>SETINSPROFILE</b> command on page 875)  | Enum          | 4            | H+8           |
| 7     | Enabled Updates            | Enabled update types  | Hex           | 4            | H+12          |
| 8     | Alignment Mode             | Alignment mode configured on the system (see the <b>ALIGNMENTMODE</b> command on page 842)                          | Enum          | 4            | H+16          |



| Field | Field Type                    | Description   | Binary Format | Binary Bytes | Binary Offset |
|-------|-------------------------------|---|---------------|--------------|---------------|
| 9     | Relative INS Output Frame     | The user specified output frame of the Relative INS Vector (see <b>SETRELINSOUTPUTFRAME</b> command on page 885)<br>If not specified, the default value appears.  | Enum          | 4            | H+20          |
| 10    | Relative INS Output Direction | The User specified Output direction of the Relative INS Vector (From or To Master-Rover) (see the <b>SETRELINSOUTPUTFRAME</b> command on page 885).<br>If not specified, the default value appears. TRUE if From Master, FALSE (Default) if From Rover                            | Bool          | 4            | H+24          |
| 11    | INS Receiver Status           | Lower byte- INS Reset. Corresponds numerically to the INS Reset as described by the INSResetEnum<br>Second byte-<br>= 0x01 if an IMU Communication Error (Receiver status bit 17).<br>= 0x00 otherwise.<br>Other values are reserved for future use.<br>Upper 2 bytes - reserved. | Hex           | 4            | H+28          |
| 12    | INS Seed Enabled              | INS Seed Enable setting (see the <b>INSSEED</b> command on page 861)<br>Enabled = 1, Disabled = 0   | Uchar         | 1            | H+32          |
| 13    | INS Seed Validation           | INS Seed Validation setting (see the <b>INSSEED</b> command on page 861)  | Uchar         | 1            | H+33          |
| 14    | Reserved 1                    |   | N/A           | 2            | H+34          |
| 15    | Reserved 2                    |   | N/A           | 4            | H+36          |
| 16    | Reserved 3                    |   | N/A           | 4            | H+40          |
| 17    | Reserved 4                    |   | N/A           | 4            | H+44          |
| 18    | Reserved 5                    |   | N/A           | 4            | H+48          |
| 19    | Reserved 6                    |   | N/A           | 4            | H+52          |

| Field    | Field Type             | Description  | Binary Format | Binary Bytes | Binary Offset |
|----------|------------------------|--|---------------|--------------|---------------|
| 20       | Reserved 7             |  | N/A           | 4            | H+56          |
| 21       | Number of Translations | Number of translation entries to follow  | Ulong         | 4            | H+60          |
| 22       | Translation            | Translation to follow (see <i>Table 187: Translation Offset Types</i> on page 881) | Enum          | 4            | variable      |
| 23       | Frame                  | Frame of translation (IMUBODY or VEHICLE)  | Enum          | 4            | variable      |
| 24       | X Offset               | X Offset   | Float         | 4            | variable      |
| 25       | Y Offset               | Y Offset   | Float         | 4            | variable      |
| 26       | Z Offset               | Z Offset   | Float         | 4            | variable      |
| 27       | X Uncertainty          | X Uncertainty  | Float         | 4            | variable      |
| 28       | Y Uncertainty          | Y Uncertainty  | Float         | 4            | variable      |
| 29       | Z Uncertainty          | Z Uncertainty  | Float         | 4            | variable      |
| 30       | Translation Source     | Source of translation (see <i>Table 194: Source Status</i> on page 927)            | Enum          | 4            | variable      |
|          | Next Translation       |  |               |              |               |
| variable | Number of Rotations    | Number of rotation entries to follow   | Ulong         | 4            | variable      |
| variable | Rotation               | Rotation to follow (see <i>Table 186: Rotational Offset Types</i> on page 878)     | Enum          | 4            | variable      |
| variable | Frame                  | Frame of rotation (IMUBODY or VEHICLE)   | Enum          | 4            | variable      |
| variable | X Rotation             | X Rotation   | Float         | 4            | variable      |
| variable | Y Rotation             | Y Rotation   | Float         | 4            | variable      |
| variable | Z Rotation             | Z Rotation   | Float         | 4            | variable      |
| variable | X Rotation Std Dev     | X Rotation offset standard deviation (degrees)                                     | Float         | 4            | variable      |
| variable | Y Rotation STD Dev     | Y Rotation offset standard deviation (degrees)                                     | Float         | 4            | variable      |
| variable | Z Rotation STD Dev     | Z Rotation offset standard deviation (degrees)                                     | Float         | 4            | variable      |

---

| Field    | Field Type      | Description  | Binary Format | Binary Bytes | Binary Offset |
|----------|-----------------|--|---------------|--------------|---------------|
| variable | Rotation Source | Source of rotation (see <i>Table 194: Source Status</i> on page 927) | Enum          | 4            | variable      |
|          | Next Rotation   |  |               |              |               |
| variable | xxxx            | 32-bit CRC (ASCII and Binary only)                                   | Hex           | 4            | variable      |
|          | [CR][LF]        | Sentence terminator (ASCII only)                                     | -             | -            | -             |

## 5.18 INSPOS

### *INS Position*

**Platform: OEM719, OEM729, OEM7500, OEM7700, OEM7720, PwrPak7, HxGN PIM7500**

This log contains the most recent position measurements in WGS84 coordinates and includes an INS status indicator. The log reports the position at the IMU center, unless the **SETINSTRANSLATION USER** command was issued. See the **SETINSTRANSLATION** command on page 880.



This log provides the position information in WGS84.

**Message ID: 265**

**Log Type: Synch**

**Recommended Input:**

```
log insposa ontime 1
```

**ASCII Example:**

```
#INSPOSA,USB2,0,18.0,FINESTEERING,1541,487977.000,02040000,17cd,37343;
1541, 487977.000549050,51.121315135,-114.042311349,1038.660737046,INS_
SOLUTION_GOOD *2fffd557
```

| Field | Field Type        | Description  | Format | Binary Bytes | Binary Offset |
|-------|-------------------|--|--------|--------------|---------------|
| 1     | INSPOS Header     | Log header. See <i>Messages</i> on page 25 for more information.       | -      | H            | 0             |
| 2     | Week              | GNSS Week  | Ulong  | 4            | H             |
| 3     | Seconds into Week | Seconds from week start  | Double | 8            | H+4           |
| 4     | Latitude          | Latitude (WGS84)   | Double | 8            | H+12          |
| 5     | Longitude         | Longitude (WGS84)  | Double | 8            | H+20          |
| 6     | Height            | Ellipsoidal Height (WGS84) [m]   | Double | 8            | H+28          |
| 7     | Status            | INS status, see <i>Table 189: Inertial Solution Status</i> on page 916 | Enum   | 4            | H+36          |
| 8     | xxxx              | 32-bit CRC (ASCII, Binary and Short Binary only)                       | Hex    | 4            | H+40          |
| 9     | [CR][LF]          | Sentence terminator (ASCII only)                                       | -      | -            | -             |

## 5.19 INSPOSS

### *Short INS Position*

**Platform: OEM719, OEM729, OEM7500, OEM7700, OEM7720, PwrPak7, HxGN PIM7500**

This log is the short header version of the **INSPOS** log (see page 932).



This log provides the position information in WGS84.

**Message ID: 321**

**Log Type: Synch**

**Recommended Input:**

```
log inspossa ontime 1
```

**ASCII Example:**

```
%INSPOSSA,1541,487916.000;1541,487916.000549050,51.115797277,-  
114.037811065,1039.030700122,INS_SOLUTION_GOOD*5ca30894
```

| Field | Field Type        | Description  | Format | Binary Bytes | Binary Offset |
|-------|-------------------|--|--------|--------------|---------------|
| 1     | INSPOSS Header    | Log header. See <i>Messages</i> on page 25 for more information.       | -      | H            | 0             |
| 2     | Week              | GNSS Week  | Ulong  | 4            | H             |
| 3     | Seconds into Week | Seconds from week start  | Double | 8            | H+4           |
| 4     | Latitude          | Latitude (WGS84)   | Double | 8            | H+12          |
| 5     | Longitude         | Longitude (WGS84)  | Double | 8            | H+20          |
| 6     | Height            | Ellipsoidal Height (WGS84) [m]   | Double | 8            | H+28          |
| 7     | Status            | INS status, see <i>Table 189: Inertial Solution Status</i> on page 916 | Enum   | 4            | H+36          |
| 8     | xxxx              | 32-bit CRC (ASCII, Binary and Short Binary only)                       | Hex    | 4            | H+40          |
| 9     | [CR][LF]          | Sentence terminator (ASCII only)                                       | -      | -            | -             |

## 5.20 INSPOSX

### *Inertial Position – Extended*

**Platform: OEM719, OEM729, OEM7500, OEM7700, OEM7720, PwrPak7, HxGN PIM7500**

This log includes the information from the INSPOS log, as well as information about the position standard deviation. The position type and solution status fields indicate whether or not the corresponding data is valid.



The INSPOSX log is a large log and is not recommend for high rate logging. If you want to use high rate logging, log the **INSPOSS** log at a high rate and the **INSSTDEVS** log ontime 1.



This log provides the position information in the user datum. To determine the datum being used, log the **BESTPOS** log.

**Message ID: 1459**

**Log Type: Synch**

**Recommended Input:**

```
log insposxa ontime 1
```

**ASCII example:**

```
#INSPOSXA,COM1,0,79.0,FINESTEERING,1690,493465.000,02000040,7211,43441
;INS_SOLUTION_GOOD,INS_PSRSP,51.11637750859,-
114.03826206294,1049.1191,0.4883,0.4765,0.8853,3,0*dee048ab
```

| Field | Field Type     | Description   | Format | Binary Bytes | Binary Offset |
|-------|----------------|---|--------|--------------|---------------|
| 1     | INSPOSX Header | Log header. See <i>Messages</i> on page 25 for more information.              |        | H            | 0             |
| 2     | INS Status     | Solution status<br>See <i>Table 189: Inertial Solution Status</i> on page 916 | Enum   | 4            | H             |
| 3     | Pos Type       | Position type<br>See <i>Table 74: Position or Velocity Type</i> on page 420   | Enum   | 4            | H+4           |
| 4     | Lat            | Latitude  | Double | 8            | H+8           |
| 5     | Long           | Longitude   | Double | 8            | H+16          |

| Field | Field Type        | Description  | Format | Binary Bytes | Binary Offset |
|-------|-------------------|--|--------|--------------|---------------|
| 6     | Height            | Height above sea level (m)   | Double | 8            | H+24          |
| 7     | Undulation        | Undulation (m)   | Float  | 4            | H+32          |
| 8     | Lat $\sigma$      | Latitude standard deviation  | Float  | 4            | H+36          |
| 9     | Long $\sigma$     | Longitude standard deviation   | Float  | 4            | H+34          |
| 10    | Height $\sigma$   | Height standard deviation  | Float  | 4            | H+44          |
| 11    | Ext sol stat      | Extended solution status<br>See <i>Table 190: Extended Solution Status</i> on page 922 | Hex    | 4            | H+48          |
| 11    | Time Since Update | Elapsed time since the last ZUPT or position update (seconds)                          | Ushort | 2            | H+52          |
| 12    | xxxx              | 32-bit CRC (ASCII and Binary only)   | Hex    | 4            | H+54          |
| 13    | [CR][LF]          | Sentence terminator (ASCII only)   | -      | -            | -             |



The INS covariance and standard deviation values reported by the SPAN filter are an estimate of the Inertial filter solution quality. In lower accuracy GNSS position modes, such as SINGLE or WAAS (see *Table 74: Position or Velocity Type* on page 420), the position covariance and standard deviation values can appear to become optimistic compared with the absolute GNSS accuracy. This is due to the INS filter's ability to smooth short term noise in the GNSS solution, although the overall position error envelope still reflects the GNSS accuracy. Therefore, if the desired application requires absolute GNSS position accuracy, it is recommended to also monitor GNSS position messages such as BESTGNSSPOS (see **BESTGNSSPOS** log on page 897).

## 5.21 INSPVA

### *INS Position, Velocity and Attitude*

**Platform: OEM719, OEM729, OEM7500, OEM7700, OEM7720, PwrPak7, HxGN PIM7500**

This log allows INS position, velocity and attitude, with respect to the SPAN frame, to be collected in one log, instead of using three separate logs. Refer to the **INSATT** log (see page 915) for an explanation of how the SPAN frame may differ from the IMU enclosure frame.



This log provides the position information in WGS84.

**Message ID: 507**

**Log Type: Synch**

**Recommended Input:**

```
log inspvaa ontime 1
```

**ASCII Example:**

```
#INSPVAA,COM1,0,31.0,FINESTEERING,1264,144088.000,02040000,5615,1541;1
264,144088.002284950,51.116827527,-
114.037738908,401.191547167,354.846489850,108.429407241,-
10.837482850,1.116219952,-3.476059035,7.372686190,INS_ALIGNMENT_
COMPLETE*af719fd9
```

| Field | Field Type     | Description   | Format | Binary Bytes | Binary Offset |
|-------|----------------|---|--------|--------------|---------------|
| 1     | INSPVA Header  | Log header. See <i>Messages</i> on page 25 for more information.                    | -      | H            | 0             |
| 2     | Week           | GNSS Week   | Ulong  | 4            | H             |
| 3     | Seconds        | Seconds from week start   | Double | 8            | H+4           |
| 4     | Latitude       | Latitude (WGS84) [degrees]  | Double | 8            | H+12          |
| 5     | Longitude      | Longitude (WGS84) [degrees]   | Double | 8            | H+20          |
| 6     | Height         | Ellipsoidal Height (WGS84) [m]  | Double | 8            | H+28          |
| 7     | North Velocity | Velocity in a northerly direction (a -ve value implies a southerly direction) [m/s] | Double | 8            | H+36          |
| 8     | East Velocity  | Velocity in an easterly direction (a -ve value implies a westerly direction) [m/s]  | Double | 8            | H+44          |



| Field | Field Type  | Description  | Format | Binary Bytes | Binary Offset |
|-------|-------------|--|--------|--------------|---------------|
| 9     | Up Velocity | Velocity in an up direction [m/s]  | Double | 8            | H+52          |
| 10    | Roll        | Right-handed rotation from local level around y-axis in degrees  | Double | 8            | H+60          |
| 11    | Pitch       | Right-handed rotation from local level around x-axis in degrees  | Double | 8            | H+68          |
| 12    | Azimuth     | Left-handed rotation around z-axis in degrees clockwise from North<br>This is the inertial azimuth calculated from the IMU gyros and the SPAN filters. | Double | 8            | H+76          |
| 13    | Status      | INS Status, see <i>Table 189: Inertial Solution Status</i> on page 916   | Enum   | 4            | H+84          |
| 14    | xxxx        | 32-bit CRC   | Hex    | 4            | H+88          |
| 15    | [CR][LF]    | Sentence Terminator (ASCII only)   | -      | -            | -             |

## 5.22 INSPVAS

### *Short INS Position, Velocity and Attitude*

**Platform: OEM719, OEM729, OEM7500, OEM7700, OEM7720, PwrPak7, HxGN PIM7500**

This log is the short header version of the **INSPVA** log (see page 936).



This log provides the position information in WGS84.

**Message ID: 508**

**Log Type: Synch**

**Recommended Input:**

```
log inspvasa ontime 1
```

**ASCII Example:**

```
%INSPVASA,1264,144059.000;1264,144059.002135700,51.116680071,-
114.037929194,515.286704183,277.896368884,84.915188605,-
8.488207941,0.759619515,-2.892414901,6.179554750,INS_ALIGNMENT_
COMPLETE*855d6f76
```

| Field | Field Type     | Description   | Format | Binary Bytes | Binary Offset |
|-------|----------------|---|--------|--------------|---------------|
| 1     | INSPVAS Header | Log header. See <i>Messages</i> on page 25 for more information.                    | -      | H            | 0             |
| 2     | Week           | GNSS Week   | Ulong  | 4            | H             |
| 3     | Seconds        | Seconds from week start   | Double | 8            | H+4           |
| 4     | Latitude       | Latitude (WGS84) [degrees]  | Double | 8            | H+12          |
| 5     | Longitude      | Longitude (WGS84) [degrees]   | Double | 8            | H+20          |
| 6     | Height         | Ellipsoidal Height (WGS84) [m]  | Double | 8            | H+28          |
| 7     | North Velocity | Velocity in a northerly direction (a -ve value implies a southerly direction) [m/s] | Double | 8            | H+36          |
| 8     | East Velocity  | Velocity in an easterly direction (a -ve value implies a westerly direction) [m/s]  | Double | 8            | H+44          |
| 9     | Up Velocity    | Velocity in an up direction [m/s]   | Double | 8            | H+52          |
| 10    | Roll           | Right-handed rotation from local level around y-axis in degrees                     | Double | 8            | H+60          |

| Field | Field Type | Description  | Format | Binary Bytes | Binary Offset |
|-------|------------|--|--------|--------------|---------------|
| 11    | Pitch      | Right-handed rotation from local level around x-axis in degrees  | Double | 8            | H+68          |
| 12    | Azimuth    | Left-handed rotation around z-axis in degrees clockwise from north<br>This is the inertial azimuth calculated from the IMU gyros and the SPAN filters. | Double | 8            | H+76          |
| 13    | Status     | INS Status, see <i>Table 189: Inertial Solution Status</i> on page 916   | Enum   | 4            | H+84          |
| 14    | xxxx       | 32-bit CRC   | Hex    | 4            | H+88          |
| 15    | [CR][LF]   | Sentence Terminator (ASCII only)   | -      | -            | -             |

## 5.23 INSPVAX

### *Inertial PVA – Extended*

**Platform: OEM719, OEM729, OEM7500, OEM7700, OEM7720, PwrPak7, HxGN PIM7500**

This log includes the information from the INSPVA log, as well as information about the position standard deviation. The position type and solution status fields indicate whether or not the corresponding data is valid.



The INSPVAX log is a large log and is not recommend for high rate logging. If you want to use high rate logging, log the **INSPVAS** log at a high rate and the **INSSTDEVS** log ontime 1.



This log provides the position information in the user datum. To determine the datum being used, log the **BESTPOS** log.

**Message ID: 1465**

**Log Type: Synch**

**Recommended Input:**

```
log inspvaxa ontime 1
```

**ASCII example:**

```
#INSPVAXA,COM1,0,73.5,FINESTEERING,1695,309428.000,02000040,4e77,43562
;INS_SOLUTION_GOOD,INS_PSRSP,51.11637873403,-
114.03825114994,1063.6093,-16.9000,-0.0845,-0.0464,-
0.0127,0.138023492,0.069459386,90.000923268,0.9428,0.6688,1.4746,0.043
0,0.0518,0.0521,0.944295466,0.944567084,1.000131845,3,0*e877c178
```

| Field | Field Type     | Data Description  | Format | Binary Bytes | Binary Offset |
|-------|----------------|---|--------|--------------|---------------|
| 1     | INSPVAX Header | Log header. See <i>Messages</i> on page 25 for more information.              |        | H            | 0             |
| 2     | INS Status     | Solution status<br>See <i>Table 189: Inertial Solution Status</i> on page 916 | Enum   | 4            | H             |
| 3     | Pos Type       | Position type<br>See <i>Table 74: Position or Velocity Type</i> on page 420   | Enum   | 4            | H+4           |
| 4     | Lat            | Latitude (degrees)  | Double | 8            | H+8           |

| Field | Field Type         | Data Description   | Format | Binary Bytes | Binary Offset |
|-------|--------------------|--|--------|--------------|---------------|
| 5     | Long               | Longitude (degrees)  | Double | 8            | H+16          |
| 6     | Height             | Height above mean sea level (m)  | Double | 8            | H+24          |
| 7     | Undulation         | Undulation (m)   | Float  | 4            | H+32          |
| 8     | North Vel          | North velocity (m/s)   | Double | 8            | H+36          |
| 9     | East Vel           | East velocity (m/s)  | Double | 8            | H+44          |
| 10    | Up Vel             | Up velocity (m/s)  | Double | 8            | H+52          |
| 11    | Roll               | Roll in Local Level (degrees)  | Double | 8            | H+60          |
| 12    | Pitch              | Pitch in Local Level (degrees)   | Double | 8            | H+68          |
| 13    | Azimuth            | Azimuth in Local Level (degrees)<br>This is the inertial azimuth calculated from the IMU gyros and the SPAN filters. | Double | 8            | H+76          |
| 14    | Lat $\sigma$       | Latitude standard deviation (m)  | Float  | 4            | H+84          |
| 15    | Long $\sigma$      | Longitude standard deviation (m)   | Float  | 4            | H+88          |
| 16    | Height $\sigma$    | Height standard deviation (m)  | Float  | 4            | H+92          |
| 17    | North Vel $\sigma$ | North velocity standard deviation (m/s)  | Float  | 4            | H+96          |
| 18    | East Vel $\sigma$  | East velocity standard deviation (m/s)   | Float  | 4            | H+100         |
| 19    | Up Vel $\sigma$    | Up velocity standard deviation (m/s)   | Float  | 4            | H+104         |
| 20    | Roll $\sigma$      | Roll standard deviation (degrees)  | Float  | 4            | H+108         |
| 21    | Pitch $\sigma$     | Pitch standard deviation (degrees)   | Float  | 4            | H+112         |
| 22    | Azimuth $\sigma$   | Azimuth standard deviation (degrees)   | Float  | 4            | H+116         |
| 23    | Ext sol stat       | Extended solution status<br>See <i>Table 190: Extended Solution Status</i> on page 922                               | Hex    | 4            | H+120         |
| 24    | Time Since Update  | Elapsed time since the last ZUPT or position update (seconds)  | Ushort | 2            | H+124         |
| 25    | xxxx               | 32-bit CRC (ASCII and Binary only)   | Hex    | 4            | H+126         |
| 26    | [CR][LF]           | Sentence terminator (ASCII only)   | -      | -            | -             |



The INS covariance and standard deviation values reported by the SPAN filter are an estimate of the Inertial filter solution quality. In lower accuracy GNSS position modes, such as SINGLE or WAAS (see *Table 74: Position or Velocity Type* on page 420), the position covariance and standard deviation values can appear to become optimistic compared with the absolute GNSS accuracy. This is due to the INS filter's ability to smooth short term noise in the GNSS solution, although the overall position error envelope still reflects the GNSS accuracy. Therefore, if the desired application requires absolute GNSS position accuracy, it is recommended to also monitor GNSS position messages such as BESTGNSSPOS (see **BESTGNSSPOS** log on page 897).

## 5.24 INSSEEDSTATUS

### *Status of INS Seed*

This log reports the current status of the INS Seed. See the [OEM7 SPAN Installation and Operation User Manual](#) for more information about an INS Seed.

**Message ID: 2129**

**Log Type: Asynch**

**Abbreviated ASCII Syntax:**

```
log insseedstatusa onnew
```

**Example:**

```
#INSSEEDSTATUSA,COM3,0,66.0,FINESTEERING,1945,315811.009,02040020,9fd0
,32768;INJECTED,TRUE,-0.098151498,0.298816800,95.888587952,-
1634544.0523482216522098,-
3664556.8064546003006399,4942534.6315599447116256,-
16.9000,0,0,0,0*f353470c
```

| Field | Field Type           | Description  | Format | Binary Bytes | Binary Offset |
|-------|----------------------|--|--------|--------------|---------------|
| 1     | INSSEEDSTATUS header | Command header. See <i>Messages</i> on page 25 for more information.   | -      | H            | 0             |
| 2     | Injection Status     | Status of the INS Seed being injected into the solution. See <i>Table 195: Injection Status</i> on the next page | Enum   | 4            | H             |
| 3     | Is Valid Status      | Flag to indicate if current seed data in NVM is valid  | Bool   | 4            | H+4           |
| 4     | Pitch                | IMU frame pitch angle (degrees)  | Float  | 4            | H+8           |
| 5     | Roll                 | IMU frame roll angle (degrees)   | Float  | 4            | H+12          |
| 6     | Azimuth              | IMU frame azimuth angle (degrees)  | Float  | 4            | H+16          |
| 7     | PositionX            | ECEF-based x-coordinate  | Double | 8            | H+20          |
| 8     | PositionY            | ECEF-based y-coordinate  | Double | 8            | H+28          |
| 9     | PositionZ            | ECEF-based z-coordinate  | Double | 8            | H+36          |
| 10    | Undulation           | Position Undulation  | Float  | 4            | H+44          |
| 11    | Reserved             |  | Ulong  | 4            | H+48          |
| 12    | Reserved             |  | Ulong  | 4            | H+52          |
| 13    | Reserved             |  | Ulong  | 4            | H+56          |

| Field | Field Type | Description                        | Format | Binary Bytes | Binary Offset |
|-------|------------|------------------------------------|--------|--------------|---------------|
| 14    | Reserved   |                                    | Ulong  | 4            | H+60          |
| 15    | xxxx       | 32-bit CRC (ASCII and Binary only) | Hex    | 4            | H+64          |
| 16    | [CR][LF]   | Sentence Terminator (ASCII only)   | -      | -            | -             |

**Table 195: Injection Status**

| Binary | ASCII           | Description                                      |
|--------|-----------------|--|
| 0      | NOT_INITIALIZED | INS Seed has not been injected into the solution |
| 1      | INVALID         | INS Seed is no longer valid                      |
| 2      | FAILED          | INS Seed has failed validation and is disabled   |
| 3      | PENDING         | INS Seed is being injected into the solution     |
| 4      | INJECTED        | INS Seed has successfully been injected          |



## 5.25 INSSPD

### *INS Speed*

**Platform: OEM719, OEM729, OEM7500, OEM7700, OEM7720, PwrPak7, HxGN PIM7500**

This log contains the most recent speed measurements in the horizontal and vertical directions and includes an INS status indicator.

**Message ID: 266**

**Log Type: Synch**

**Recommended Input:**

```
log insspda ontime 1
```

**ASCII Example:**

```
#INSSPDA,USB2,0,20.0,FINESTEERING,1541,487969.000,02040000,7832,37343;
1541,487969.000549050,329.621116190,14.182070674,-0.126606551,INS_
SOLUTION_GOOD *c274fff2
```

| Field | Field Type        | Description  | Format | Binary Bytes | Binary Offset |
|-------|-------------------|--|--------|--------------|---------------|
| 1     | INSSPD Header     | Log header. See <i>Messages</i> on page 25 for more information.   | -      | H            | 0             |
| 2     | Week              | GNSS Week  | Ulong  | 4            | H             |
| 3     | Seconds into Week | Seconds from week start  | Double | 8            | H+4           |
| 4     | Trk gnd           | Actual direction of motion over ground (track over ground) with respect to True North, in degrees<br><br>The track over ground is determined by comparing the current position determined from the GNSS/INS solution with the previously determined position.<br><br>Track over ground is best used when the vehicle is moving. When the vehicle is stationary, position error can make the direction of motion appear to change randomly. | Double | 8            | H+12          |
| 5     | Horizontal Speed  | Magnitude of horizontal speed in m/s where a positive value indicates forward movement and a negative value indicates reverse movement.  | Double | 8            | H+20          |

| Field | Field Type     | Description   | Format | Binary Bytes | Binary Offset |
|-------|----------------|---|--------|--------------|---------------|
| 6     | Vertical Speed | Magnitude of vertical speed in m/s where a positive value indicates speed upward and a negative value indicates speed downward. | Double | 8            | H+28          |
| 7     | Status         | INS status, see <i>Table 189: Inertial Solution Status</i> on page 916  | Enum   | 4            | H+36          |
| 8     | xxxx           | 32-bit CRC (ASCII, Binary and Short Binary only)  | Hex    | 4            | H+40          |
| 9     | [CR][LF]       | Sentence terminator (ASCII only)  | -      | -            | -             |

## 5.26 INSSPDS

### *Short INS Speed*

**Platform: OEM719, OEM729, OEM7500, OEM7700, OEM7720, PwrPak7, HxGN PIM7500**

This log is the short header version of the **INSSPD** log (see page 945).

**Message ID: 323**

**Log Type: Synch**

**Recommended Input:**

```
log insspdsa ontime 1
```

**ASCII Example:**

```
%INSSPDSA,1541,487975.000;1541,487975.000549050,323.101450813,9.787233  
999,-0.038980077,INS_SOLUTION_GOOD*105ba028
```

| Field | Field Type        | Description   | Format | Binary Bytes | Binary Offset |
|-------|-------------------|---|--------|--------------|---------------|
| 1     | INSSPDS Header    | Log header. See <i>Messages</i> on page 25 for more information.  | -      | H            | 0             |
| 2     | Week              | GNSS Week   | Ulong  | 4            | H             |
| 3     | Seconds into Week | Seconds from week start   | Double | 8            | H+4           |
| 4     | Trk gnd           | Actual direction of motion over ground (track over ground) with respect to True North, in degrees.<br><br>The track over ground is determined by comparing the current position determined from the GNSS/INS solution with the previously determined position.<br><br>Track over ground is best used when the vehicle is moving. When the vehicle is stationary, position error can make the direction of motion appear to change randomly. | Double | 8            | H+12          |
| 5     | Horizontal Speed  | Magnitude of horizontal speed in m/s where a positive value indicates forward movement and a negative value indicates reverse movement.   | Double | 8            | H+20          |
| 6     | Vertical Speed    | Magnitude of vertical speed in m/s where a positive value indicates speed upward and a negative value indicates speed downward.   | Double | 8            | H+28          |

---

| Field | Field Type | Description  | Format | Binary Bytes | Binary Offset |
|-------|------------|--|--------|--------------|---------------|
| 7     | Status     | INS status, see <i>Table 189: Inertial Solution Status</i> on page 916 | Enum   | 4            | H+36          |
| 8     | xxxx       | 32-bit CRC (ASCII, Binary and Short Binary only)                       | Hex    | 4            | H+40          |
| 9     | [CR][LF]   | Sentence terminator (ASCII only)                                       | -      | -            | -             |

## 5.27 INSSTDEV

### *INS PVA standard deviations*

**Platform: OEM719, OEM729, OEM7500, OEM7700, OEM7720, PwrPak7, HxGN PIM7500**

This log displays the INS PVA standard deviations.

**Message ID: 2051**

**Log Type: Synch**

**Abbreviated ASCII Syntax:**

```
log insstdev ontime 1
```

**ASCII Example:**

```
#INSSTDEVA,COM1,0,78.0,FINESTEERING,1907,233990.000,02000020,3e6d,32768;0.4372,0.3139,0.7547,0.0015,0.0015,0.0014,3.7503,3.7534,5.1857,26000005,0,0,01ffd1bf,0*3deca7d2
```

| Field | Field Type              | Description  | Binary Format | Binary Bytes | Binary Offset |
|-------|-------------------------|--|---------------|--------------|---------------|
| 1     | INSSTDEV Header         | Log header. See <i>Messages</i> on page 25 for more information.                       | -             | H            | 0             |
| 2     | Latitude $\sigma$       | Latitude standard deviation (m)  | Float         | 4            | H             |
| 3     | Longitude $\sigma$      | Longitude standard deviation (m)   | Float         | 4            | H+4           |
| 4     | Height $\sigma$         | Height standard deviation (m)  | Float         | 4            | H+8           |
| 5     | North Velocity $\sigma$ | North velocity standard deviation (m/s)  | Float         | 4            | H+12          |
| 6     | East Velocity $\sigma$  | East velocity standard deviation (m/s)   | Float         | 4            | H+16          |
| 7     | Up Velocity $\sigma$    | Up velocity standard deviation (m/s)   | Float         | 4            | H+20          |
| 8     | Roll $\sigma$           | Roll standard deviation (degrees)  | Float         | 4            | H+24          |
| 9     | Pitch $\sigma$          | Pitch standard deviation (degrees)   | Float         | 4            | H+28          |
| 10    | Azimuth $\sigma$        | Azimuth standard deviation (degrees)   | Float         | 4            | H+32          |
| 11    | Ext sol stat            | Extended solution status<br>See <i>Table 190: Extended Solution Status</i> on page 922 | Ulong         | 4            | H+36          |

| <b>Field</b> | <b>Field Type</b> | <b>Description</b>  | <b>Binary Format</b> | <b>Binary Bytes</b> | <b>Binary Offset</b> |
|--------------|-------------------|---|----------------------|---------------------|----------------------|
| 12           | Time Since Update | Elapsed time since the last ZUPT or position update (seconds) | Ushort               | 2                   | H+40                 |
| 13           | Reserved          |   | Ushort               | 2                   | H+42                 |
| 14           | Reserved          |   | Ulong                | 4                   | H+44                 |
| 15           | Reserved          |   | Ulong                | 4                   | H+48                 |
| 16           | xxxx              | 32-bit CRC (ASCII and Binary only).                           | Hex                  | 4                   | H+52                 |
| 17           | [CR][LF]          | Sentence terminator (ASCII only).                             | -                    | -                   | -                    |

## 5.28 INSSTDEVS

### *Short INS PVA standard deviations*

**Platform:** OEM719, OEM729, OEM7500, OEM7700, OEM7720, PwrPak7, HxGN PIM7500

This log is the short header version of the **INSSTDEV** log (see page 949).

**Message ID:** 2052

**Log Type:** Synch

**Abbreviated ASCII Syntax:**

```
log insstdevs ontime 1
```

**ASCII Example:**

```
%INSSTDEVSA,1907,233990.000;0.4372,0.3139,0.7547,0.0015,0.0015,0.0014,3.7503,3.7534,5.1857,26000005,0,0,01ffd1bf,0*2c967ced
```

| Field | Field Type              | Description  | Binary Format | Binary Bytes | Binary Offset |
|-------|-------------------------|--|---------------|--------------|---------------|
| 1     | INSSTDEV Header         | Log header. See <i>Messages</i> on page 25 for more information.                       | -             | H            | 0             |
| 2     | Latitude $\sigma$       | Latitude standard deviation (m)  | Float         | 4            | H             |
| 3     | Longitude $\sigma$      | Longitude standard deviation (m)   | Float         | 4            | H+4           |
| 4     | Height $\sigma$         | Height standard deviation (m)  | Float         | 4            | H+8           |
| 5     | North Velocity $\sigma$ | North velocity standard deviation (m/s)  | Float         | 4            | H+12          |
| 6     | East Velocity $\sigma$  | East velocity standard deviation (m/s)   | Float         | 4            | H+16          |
| 7     | Up Velocity $\sigma$    | Up velocity standard deviation (m/s)   | Float         | 4            | H+20          |
| 8     | Roll $\sigma$           | Roll standard deviation (degrees)  | Float         | 4            | H+24          |
| 9     | Pitch $\sigma$          | Pitch standard deviation (degrees)   | Float         | 4            | H+28          |
| 10    | Azimuth $\sigma$        | Azimuth standard deviation (degrees)   | Float         | 4            | H+32          |
| 11    | Ext sol stat            | Extended solution status<br>See <i>Table 190: Extended Solution Status</i> on page 922 | Ulong         | 4            | H+36          |

| <b>Field</b> | <b>Field Type</b> | <b>Description</b>  | <b>Binary Format</b> | <b>Binary Bytes</b> | <b>Binary Offset</b> |
|--------------|-------------------|---|----------------------|---------------------|----------------------|
| 12           | Time Since Update | Elapsed time since the last ZUPT or position update (seconds) | Ushort               | 2                   | H+40                 |
| 13           | Reserved          |   | Ushort               | 2                   | H+42                 |
| 14           | Reserved          |   | Ulong                | 4                   | H+44                 |
| 15           | Reserved          |   | Ulong                | 4                   | H+48                 |
| 16           | xxxx              | 32-bit CRC (ASCII and Binary only).                           | Hex                  | 4                   | H+52                 |
| 17           | [CR][LF]          | Sentence terminator (ASCII only).                             | -                    | -                   | -                    |



## 5.29 INSUPDATESTATUS

### *INS Update Status*

**Platform: OEM719, OEM729, OEM7500, OEM7700, OEM7720, PwrPak7, HxGN PIM7500**

This log provides the most recent INS update information. It provides information about what updates were performed in the INS filter at the last update epoch and a wheel sensor status indicator.

**Message ID: 1825**

**Log Type: Asynch**

**Recommended Input:**

```
log insupdatestatus onchanged
```

**ASCII Example:**

```
#INSUPDATESTATUSA,COM2,0,76.0,FINESTEERING,1934,149288.000,02000000,78f1,32768;SINGLE,0,0,0,INACTIVE,INACTIVE,00000005,00ffd1bf,0,0*d6b7ee02
```

| Field | Field Type              | Description   | Format  | Binary Bytes | Binary Offset |
|-------|-------------------------|---|---------|--------------|---------------|
| 1     | INSUPDATE STATUS Header | Log header. See <i>Messages</i> on page 25 for more information.  | -       | H            | 0             |
| 2     | PosType                 | Type of GNSS solution used for the last INS filter update. See <i>Table 74: Position or Velocity Type</i> on page 420 | Enum    | 4            | H             |
| 3     | NumPSR                  | Number of raw pseudorange observations used in the last INS filter update.  | Integer | 4            | H+4           |
| 4     | NumADR                  | Number of raw phase observations used in the last INS filter update.  | Integer | 4            | H+8           |
| 5     | NumDOP                  | Number of raw doppler observations used in the last INS filter update.  | Integer | 4            | H+12          |

| Field | Field Type            | Description  | Format | Binary Bytes | Binary Offset |
|-------|-----------------------|--|--------|--------------|---------------|
| 6     | DMI Update Status     | Distance measurement instrument (wheel sensor) status<br>0 = INACTIVE<br>1 = ACTIVE<br>2 = USED<br>3 = UNSYNCED<br>4 = BAD_MISC<br>5 = HIGH_ROTATION<br>6 = DISABLED<br>7 = ZUPT | Enum   | 4            | H+16          |
| 7     | Heading Update Status | Status of the heading update during the last INS filter update.<br>See <i>Table 196: Heading Update Values</i> below   | Enum   | 4            | H+20          |
| 8     | Ext sol stat          | Extended solution status<br>See <i>Table 190: Extended Solution Status</i> on page 922   | Ulong  | 4            | H+24          |
| 9     | INS Update Options    | INS Update Options mask.<br>See <i>Table 197: INS Update Status</i> on the next page   | Ulong  | 4            | H+28          |
| 10    | Reserved              |  | Ulong  | 4            | H+32          |
| 11    | Reserved              |  | Ulong  | 4            | H+36          |
| 12    | xxxx                  | 32-bit CRC (ASCII, Binary and Short Binary only)   | Hex    | 4            | H+40          |
| 13    | [CR][LF]              | Sentence terminator (ASCII only)   | -      | -            | -             |

**Table 196: Heading Update Values**

| Binary | ASCII                   | Description   |
|--------|-------------------------|---|
| 0      | INACTIVE                | A heading update was not available.   |
| 1      | ACTIVE                  | Heading updates are running, but the epoch is not used as an update. When all other rejection criteria pass, a heading update will still only be applied once every 5 seconds (20 seconds when stationary). |
| 2      | USED                    | The update for that epoch was taken.  |
| 5      | HEADING_UPDATE_BAD_MISC | Heading updates are running, but was not performed this epoch due to a large disagreement with filter estimates.  |

**Table 197: INS Update Status**

| Nibble | Bit | Mask       | Description               | Range Value                 |
|--------|-----|------------|---------------------------|-----------------------------|
| N0     | 0   | 0x00000001 | Position update           | 0 = Disabled<br>1 = Enabled |
|        | 1   | 0x00000002 | Phase update              | 0 = Disabled<br>1 = Enabled |
|        | 2   | 0x00000004 | Zero velocity update      | 0 = Disabled<br>1 = Enabled |
|        | 3   | 0x00000008 | Wheel sensor update       | 0 = Disabled<br>1 = Enabled |
| N1     | 4   | 0x00000010 | ALIGN (heading) update    | 0 = Disabled<br>1 = Enabled |
|        | 5   | 0x00000020 | External position update  | 0 = Disabled<br>1 = Enabled |
|        | 6   | 0x00000040 | Reserved                  |                             |
|        | 7   | 0x00000080 | Doppler update            | 0 = Disabled<br>1 = Enabled |
| N2     | 8   | 0x00000100 | Pseudorange update        | 0 = Disabled<br>1 = Enabled |
|        | 9   | 0x00000200 | Velocity update           | 0 = Disabled<br>1 = Enabled |
|        | 10  | 0x00000400 | Reserved                  |                             |
|        | 11  | 0x00000800 | Dead reckoning update     | 0 = Disabled<br>1 = Enabled |
| N3     | 12  | 0x00001000 | Phase wind up update      | 0 = Disabled<br>1 = Enabled |
|        | 13  | 0x00002000 | Course over ground update | 0 = Disabled<br>1 = Enabled |
|        | 14  | 0x00004000 | External velocity update  | 0 = Disabled<br>1 = Enabled |
|        | 15  | 0x00008000 | External attitude update  | 0 = Disabled<br>1 = Enabled |

| <b>Nibble</b> | <b>Bit</b> | <b>Mask</b> | <b>Description</b>      | <b>Range Value</b>          |
|---------------|------------|-------------|-------------------------|-----------------------------|
| N4            | 16         | 0x00010000  | External heading update | 0 = Disabled<br>1 = Enabled |
|               | 17         | 0x00020000  | External height update  | 0 = Disabled<br>1 = Enabled |
|               | 18         | 0x00040000  | Reserved                |                             |
|               | 19         | 0x00080000  | Reserved                |                             |

## 5.30 INSVEL

### *INS Velocity*

**Platform: OEM719, OEM729, OEM7500, OEM7700, OEM7720, PwrPak7, HxGN PIM7500**

This log contains the most recent North, East and Up velocity vector values, with respect to the local level frame and also includes an INS status indicator.

**Message ID: 267**

**Log Type: Synch**

**Recommended Input:**

```
log insvela ontime 1
```

**ASCII Example:**

```
#INSVELA,USB1,0,19.0,FINESTEERING,1543,236173.000,02000000,9c95,37343;
1543,236173.002500000,14.139471871,-0.070354464,-0.044204369,INS_
SOLUTION_GOOD*3c37c0fc
```

| Field | Field Type        | Description  | Format | Binary Bytes | Binary Offset |
|-------|-------------------|--|--------|--------------|---------------|
| 1     | INSVEL Header     | Log header. See <i>Messages</i> on page 25 for more information.       | -      | H            | 0             |
| 2     | Week              | GNSS Week  | Ulong  | 4            | H             |
| 3     | Seconds into Week | Seconds from week start  | Double | 8            | H+4           |
| 4     | North Velocity    | Velocity North in m/s  | Double | 8            | H+12          |
| 5     | East Velocity     | Velocity East in m/s   | Double | 8            | H+20          |
| 6     | Up Velocity       | Velocity Up in m/s   | Double | 8            | H+28          |
| 7     | Status            | INS status, see <i>Table 189: Inertial Solution Status</i> on page 916 | Enum   | 4            | H+36          |
| 8     | xxxx              | 32-bit CRC (ASCII, Binary and Short Binary only)                       | Hex    | 4            | H+40          |
| 9     | [CR][LF]          | Sentence terminator (ASCII only)                                       | -      | -            | -             |

## 5.31 INSVELS

### *Short INS Velocity*

**Platform: OEM719, OEM729, OEM7500, OEM7700, OEM7720, PwrPak7, HxGN PIM7500**

This log is the short header version of the **INSVEL** log (see page 957).

**Message ID: 324**

**Log Type: Synch**

**Recommended Input:**

```
log insvelsa ontime 1
```

**ASCII Example:**

```
%INSVELSA,1921,152855.200;1921,152855.200000000,0.1077,-9.8326,-0.1504,INS_
SOLUTION_GOOD*efd71f65
```

| Field | Field Type        | Description  | Format | Binary Bytes | Binary Offset |
|-------|-------------------|--|--------|--------------|---------------|
| 1     | INSVELS Header    | Log header. See <i>Messages</i> on page 25 for more information.       | -      | H            | 0             |
| 2     | Week              | GNSS Week  | Ulong  | 4            | H             |
| 3     | Seconds into Week | Seconds from week start  | Double | 8            | H+4           |
| 4     | North Velocity    | Velocity North m/s   | Double | 8            | H+12          |
| 5     | East Velocity     | Velocity East m/s  | Double | 8            | H+20          |
| 6     | Up Velocity       | Velocity Up m/s  | Double | 8            | H+28          |
| 7     | Status            | INS status, see <i>Table 189: Inertial Solution Status</i> on page 916 | Enum   | 4            | H+36          |
| 8     | xxxx              | 32-bit CRC (ASCII, Binary and Short Binary only)                       | Hex    | 4            | H+40          |
| 9     | [CR][LF]          | Sentence terminator (ASCII only)                                       | -      | -            | -             |

## 5.32 INSVELX

### *Inertial Velocity – Extended*

**Platform: OEM719, OEM729, OEM7500, OEM7700, OEM7720, PwrPak7, HxGN PIM7500**

This log includes the information from the INSVEL log, as well as information about the velocity standard deviation. The position type and solution status fields indicate whether or not the corresponding data is valid.



The INSVELX log is a large log and is not recommend for high rate logging. If you want to use high rate logging, log the **INSVELS** log at a high rate and the **INSSTDEVS** log ontime 1.

**Message ID: 1458**

**Log Type: Synch**

**Recommended Input:**

```
log insvelxa ontime 1
```

**ASCII example:**

```
#INSVELXA,COM1,0,80.0,FINESTEERING,1690,494394.000,02000040,1f8e,43441
;INS_ALIGNMENT_COMPLETE,INS_
PSRSP,0.0086,0.0015,0.0215,0.0549,0.0330,0.0339,3,0*ec33e372
```

| Field | Field Type         | Description   | Format | Binary Bytes | Binary Offset |
|-------|--------------------|---|--------|--------------|---------------|
| 1     | INSVELX Header     | Log header. See <i>Messages</i> on page 25 for more information.              |        | H            | 0             |
| 2     | INS Status         | Solution status<br>See <i>Table 189: Inertial Solution Status</i> on page 916 | Enum   | 4            | H             |
| 3     | Pos Type           | Position type<br>See <i>Table 74: Position or Velocity Type</i> on page 420   | Enum   | 4            | H+4           |
| 4     | North Vel          | North velocity (m/s)  | Double | 8            | H+8           |
| 5     | East Vel           | East velocity (m/s)   | Double | 8            | H+16          |
| 6     | Up Vel             | Up velocity (m/s)   | Double | 8            | H+24          |
| 7     | North Vel $\sigma$ | North velocity standard deviation (m/s)                                       | Float  | 4            | H+32          |
| 8     | East Vel $\sigma$  | East velocity standard deviation (m/s)  | Float  | 4            | H+36          |

| Field | Field Type        | Description  | Format | Binary Bytes | Binary Offset |
|-------|-------------------|--|--------|--------------|---------------|
| 9     | Up Vel $\sigma$   | Up velocity standard deviation (m/s)   | Float  | 4            | H+40          |
| 10    | Ext sol stat      | Extended solution status<br>See <i>Table 190: Extended Solution Status</i> on page 922 | Hex    | 4            | H+44          |
| 11    | Time Since Update | Elapsed time since the last ZUPT or position update (seconds)                          | Ushort | 2            | H+48          |
| 11    | xxxx              | 32-bit CRC (ASCII and Binary only)   | Hex    | 4            | H+50          |
| 12    | [CR][LF]          | Sentence terminator (ASCII only)   | -      | -            | -             |



## 5.33 MARK1PVA, MARK2PVA, MARK3PVA and MARK4PVA

### *Position, Velocity and Attitude at Mark Input Event*

**Platform: OEM719, OEM729, OEM7500, OEM7700, OEM7720, PwrPak7, HxGN PIM7500**

These logs output position, velocity and attitude information, with respect to the SPAN frame, when an event is received on the Mark input. If the **SETINSTRANSLATION** command (see page 880) and **SETINSROTATION** command (see page 877) has been entered with a MARKx parameter, the MARKxPVA log will contain the solution translated, and then rotated, by the values provided in the commands (e.g. **SETINSTRANSLATION MARK1** and **SETINSROTATION MARK1** commands for the MARK1PVA log). See the **SETINSTRANSLATION** command on page 880 and **SETINSROTATION** command on page 877.



The MARKxPVA logs available are dependent on the receiver used in the SPAN system. For information about the Event lines supported, see the Strobe Specifications for the receiver in the [OEM7 SPAN Installation and Operation User Manual](#).

**Message ID:**       **1067 (MARK1PVA)**  
                           **1068 (MARK2PVA)**  
                           **1118 (MARK3PVA)**  
                           **1119 (MARK4PVA)**

**Log Type: Synch**

**Recommended Input:**

```
log mark1pva onnew
log mark2pva onnew
log mark3pva onnew
log mark4pva onnew
```

**Abbreviated ASCII Example:**

```
#MARK1PVAA,COM1,0,74.5,FINESTEERING,1732,247231.455,02040020,5790,
12002;1732,247231.454623850,51.11693182283,-114.03885213810,1047.4525,
0.0004,0.0004,-0.0006,0.847121689,1.124640813,278.577037489,
INS_SOLUTION_GOOD*5a6b060e

#MARK2PVAA,COM1,0,74.5,FINESTEERING,1732,247232.271,02040020,2425,
12002;1732,247232.271459820,51.11693179023,-114.03885206704,1047.4529,
0.0004,-0.0011,-0.0007,0.837101074,1.134127754,278.346498557,
INS_SOLUTION_GOOD*08209ec0

#MARK3PVAA,COM1,0,74.5,FINESTEERING,1732,247232.271,02040020,2425,
12002;1732,247232.271459820,51.11693179023,-114.03885206704,1047.4529,
0.0004,-0.0011,-0.0007,0.837101074,1.134127754,278.346498557,
INS_SOLUTION_GOOD*08209ec0

#MARK4PVAA,COM1,0,74.5,FINESTEERING,1732,247232.271,02040020,2425,
12002;1732,247232.271459820,51.11693179023,-114.03885206704,1047.4529,
```

0.0004,-0.0011,-0.0007,0.837101074,1.134127754,278.346498557,  
INS\_SOLUTION\_GOOD\*08209ec0

| Field | Field Type      | Description   | Format | Binary Bytes | Binary Offset |
|-------|-----------------|---|--------|--------------|---------------|
| 1     | MARKxPVA Header | Log header. See <i>Messages</i> on page 25 for more information.                                  | -      | H            | 0             |
| 2     | Week            | GNSS Week at Mark input   | Ulong  | 4            | H             |
| 3     | Seconds         | Seconds from week at Mark input   | Double | 8            | H+4           |
| 4     | Latitude        | Latitude (WGS84) at Mark input  | Double | 8            | H+12          |
| 5     | Longitude       | Longitude (WGS84) at Mark input   | Double | 8            | H+20          |
| 6     | Height          | Height (WGS84) at Mark input (m)  | Double | 8            | H+28          |
| 7     | North Velocity  | Velocity in a northerly direction (a -ve value implies a southerly direction) at Mark input (m/s) | Double | 8            | H+36          |
| 8     | East Velocity   | Velocity in an easterly direction (a -ve value implies a westerly direction) at Mark input (m/s)  | Double | 8            | H+44          |
| 9     | Up Velocity     | Velocity in an up direction at Mark input (m/s)   | Double | 8            | H+52          |
| 10    | Roll            | Right-handed rotation from local level around y-axis in degrees at Mark input                     | Double | 8            | H+60          |
| 11    | Pitch           | Right-handed rotation from local level around x-axis in degrees at Mark input                     | Double | 8            | H+68          |
| 12    | Azimuth         | Left-handed rotation around z-axis in degrees clockwise from North at Mark input                  | Double | 8            | H+76          |
| 13    | Status          | INS Status, see <i>Table 189: Inertial Solution Status</i> on page 916 at Mark input              | Enum   | 4            | H+84          |
| 14    | xxxx            | 32-bit CRC  | Hex    | 4            | H+88          |
| 15    | [CR][LF]        | Sentence Terminator (ASCII only)  | -      | -            | -             |

## 5.34 PASHR

### *NMEA, Inertial Attitude Data*

**Platform: OEM719, OEM729, OEM7500, OEM7700, OEM7720, PwrPak7, HxGN PIM7500**

The PASHR log uses a UTC time, calculated with default parameters, to output NMEA messages without waiting for a valid almanac. The UTC time status is set to WARNING since it may not be 100% accurate. When a valid almanac is available, the receiver uses the real parameters and sets the UTC time to VALID. For more information about NMEA, refer to *NMEA Standard Logs* on page 600. The PASHR log contains only INS derived attitude information and is only filled when an inertial solution is available.



As of firmware version 7.03.00, an INS status flag (field 12) has been added to the PASHR log. This change was made to match the industry accepted form of the message. Previous firmware versions on OEM7 and OEM6 do not output this field.

**Message ID: 1177**

**Log Type: Synch**

**Recommended Input:**

```
log pashr ontime 1
```

**Example:**

```
$PASHR,,,,,,,,,0,0*74 (empty)
```

```
$PASHR,200345.00,78.00,T,-3.00,+2.00,+0.00,1.000,1.000,1.000,1,1*32
```

| Field | Structure    | Description   | Symbol    | Example   |
|-------|--------------|---|-----------|-----------|
| 1     | \$PASHR      | Log header. See <i>Messages</i> on page 25 for more information.  | ---       | \$PASHR   |
| 2     | Time         | UTC Time  | hhmmss.ss | 195124.00 |
| 3     | Heading      | Heading value in decimal degrees<br>The heading is the inertial azimuth calculated from the IMU gyros and the SPAN filters. | HHH.HH    | 305.30    |
| 4     | True Heading | T displayed if heading is relative to true north.   | T         | T         |
| 5     | Roll         | Roll in decimal degrees.<br>The ± sign will always be displayed.  | RRR.RR    | +0.05     |
| 6     | Pitch        | Pitch in decimal degrees.<br>The ± sign will always be displayed.   | PPP.PP    | -0.13     |

| Field | Structure               | Description   | Symbol | Example  |
|-------|-------------------------|---|--------|----------|
| 7     | Reserved                | -----   | ----   | ----     |
| 8     | Roll Accuracy           | Roll standard deviation in decimal degrees.   | rr.rrr | 0.180    |
| 9     | Pitch Accuracy          | Pitch standard deviation in decimal degrees.  | pp.ppp | 0.185    |
| 10    | Heading Accuracy        | Heading standard deviation in decimal degrees.  | hh.hhh | 4.986    |
| 11    | GPS Update Quality Flag | 0 = No position<br>1 = All non-RTK fixed integer positions<br>2 = RTK fixed integer position  | 1      | 1        |
| 12    | INS Status Flag         | 0 = All SPAN Pre-Alignment INS Status<br>1 = All SPAN Post-Alignment INS Status - These include:<br>INS_ALIGNMENT_COMPLETE, INS_SOLUTION_GOOD, INS_HIGH_VARIANCE, INS_SOLUTION_FREE | 1      | 1        |
| 13    | Checksum                | Checksum  | *XX    | *2B      |
| 14    | [CR][LF]                | Sentence terminator   |        | [CR][LF] |

## 5.35 RAWIMU

### *Raw IMU Data*

**Platform: OEM719, OEM729, OEM7500, OEM7700, OEM7720, PwrPak7, HxGN PIM7500**

This log contains an IMU status indicator and the measurements from the accelerometers and gyros with respect to the IMU enclosure frame. If logging this data, consider the **RAWIMUS** log (see page 986) to reduce the amount of data.

**Message ID: 268**

**Log Type: Asynch**

**Recommended Input:**

```
log rawimua onnew
```

**ASCII Example:**

```
#RAWIMUA, COM1, 0, 68.5, FINESTEERING, 1724, 219418.009, 024c0040, 6125, 30019;
1724, 219418.008755000, 00000077, 64732, 56, 298, 8, 28, -3*7378486f
```

| Field | Field Type        | Description  | Format | Binary Bytes | Binary Offset |
|-------|-------------------|--|--------|--------------|---------------|
| 1     | RAWIMU Header     | Log header. See <i>Messages</i> on page 25 for more information. | -      | H            | 0             |
| 2     | Week              | GNSS Week  | Ulong  | 4            | H             |
| 3     | Seconds into Week | Seconds from week start  | Double | 8            | H+4           |

| Field | Field Type     | Description  | Format    | Binary Bytes | Binary Offset |
|-------|----------------|--|-----------|--------------|---------------|
| 4     | IMU Status     | <p>The status of the IMU. This field is given in a fixed length (n) array of bytes in binary but in ASCII or Abbreviated ASCII is converted into 2 character hexadecimal pairs.</p> <p>For the raw IMU status, see one of the following tables:</p> <ul style="list-style-type: none"> <li>• <i>Table 198: iIMU-FSAS IMU Status</i> on page 969</li> <li>• <i>Table 199: HG1700 IMU Status</i> on page 970</li> <li>• <i>Table 200: LN200 IMU Status</i> on page 971</li> <li>• <i>Table 201: ISA-100C IMU Status</i> on page 973</li> <li>• <i>Table 202: IMU-CPT IMU Status</i> on page 974</li> <li>• <i>Table 203: IMU-KVH1750 IMU Status</i> on page 976</li> <li>• <i>Table 204: HG1900 and HG1930 IMU Status</i> on page 977</li> <li>• <i>Table 205: ADIS16488 and IMU-IGM-A1 IMU Status</i> on page 979</li> <li>• <i>Table 206: STIM300 and IMU-IGM-S1 IMU Status</i> on page 981</li> <li>• <i>Table 205: ADIS16488 and IMU-IGM-A1 IMU Status</i> on page 979</li> <li>• <i>Table 208: G320N IMU Status</i> on page 984</li> </ul> <p>Also refer to Interface Control Documentation as provided by Honeywell or Northrop Grumman.</p> | Hex Ulong | 4            | H+12          |
| 5     | Z Accel Output | <p>Change in velocity count along z axis</p> <p>The change in velocity (acceleration) scale factor for each IMU type can be found in <i>Table 209: Raw IMU Scale Factors</i> on page 990. Multiply the scale factor in <i>Table 209: Raw IMU Scale Factors</i> on page 990 by the count in this field for the velocity increments.</p>   | Long      | 4            | H+16          |

| Field | Field Type         | Description   | Format | Binary Bytes | Binary Offset |
|-------|--------------------|---|--------|--------------|---------------|
| 6     | - (Y Accel Output) | <p>- (Change in velocity count along y axis)</p> <p>The change in velocity (acceleration) scale factor for each IMU type can be found in <i>Table 209: Raw IMU Scale Factors</i> on page 990. Multiply the scale factor in <i>Table 209: Raw IMU Scale Factors</i> on page 990 by the count in this field for the velocity increments.</p> <p>A negative value implies the output is along the positive y-axis marked on the IMU. A positive value implies the change is in the direction opposite to that of the y-axis marked on the IMU.</p>   | Long   | 4            | H+20          |
| 7     | X Accel Output     | <p>Change in velocity count along x axis</p> <p>The change in velocity (acceleration) scale factor for each IMU type can be found in <i>Table 209: Raw IMU Scale Factors</i> on page 990. Multiply the scale factor in <i>Table 209: Raw IMU Scale Factors</i> on page 990 by the count in this field for the velocity increments.</p>  | Long   | 4            | H+24          |
| 8     | Z Gyro Output      | <p>Change in angle count around z axis.<br/>Right-handed</p> <p>The change in angle (gyro) scale factor can be found in <i>Table 209: Raw IMU Scale Factors</i> on page 990. Multiply the appropriate scale factor in <i>Table 209: Raw IMU Scale Factors</i> on page 990 by the count in this field for the angle increments in radians.</p> <p>To obtain acceleration in <math>m/s^2</math>, multiply the velocity increments by the output rate of the IMU (e.g., 100 Hz for HG1700, HG1900 and HG1930; 200 Hz for ISA-100C, iMAR-FSAS, LN200, KVH1750 and ADIS16488; 125 Hz for STIM300 and G320N).</p> | Long   | 4            | H+28          |

| Field | Field Type        | Description  | Format | Binary Bytes | Binary Offset |
|-------|-------------------|--|--------|--------------|---------------|
| 9     | - (Y Gyro Output) | <p>- (Change in angle count around y axis) <sup>3</sup>. Right-handed</p> <p>The change in angle (gyro) scale factor can be found in <i>Table 209: Raw IMU Scale Factors</i> on page 990. Multiply the appropriate scale factor in <i>Table 209: Raw IMU Scale Factors</i> on page 990 by the count in this field for the angle increments in radians.</p> <p>To obtain acceleration in m/s<sup>2</sup>, multiply the velocity increments by the output rate of the IMU (e.g., 100 Hz for HG1700, HG1900 and HG1930; 200 Hz for ISA-100C, iMAR-FSAS, LN200, KVH1750 and ADIS16488; 125 Hz for STIM300 and G320N).</p> <p>A negative value implies the output is along the positive y-axis marked on the IMU. A positive value implies the change is in the direction opposite to that of the y-axis marked on the IMU.</p> | Long   | 4            | H+32          |
| 10    | X Gyro Output     | <p>Change in angle count around x axis <sup>3</sup>. Right-handed</p> <p>The change in angle (gyro) scale factor can be found in <i>Table 209: Raw IMU Scale Factors</i> on page 990. Multiply the appropriate scale factor in <i>Table 209: Raw IMU Scale Factors</i> on page 990 by the count in this field for the angle increments in radians.</p> <p>To obtain acceleration in m/s<sup>2</sup>, multiply the velocity increments by the output rate of the IMU (e.g., 100 Hz for HG1700, HG1900 and HG1930; 200 Hz for ISA-100C, iMAR-FSAS, LN200, KVH1750 and ADIS16488; 125 Hz for STIM300 and G320N).</p>  | Long   | 4            | H+36          |
| 11    | xxxx              | 32-bit CRC (ASCII, Binary and Short Binary only)   | Hex    | 4            | H+40          |
| 12    | [CR][LF]          | Sentence terminator (ASCII only)   | -      | -            | -             |



**Table 198: iIMU-FSAS IMU Status**

| Nibble | Bit | Mask       | Description                     | Range Value            |
|--------|-----|------------|---------------------------------|------------------------|
| N0     | 0   | 0x00000001 | Reserved                        |                        |
|        | 1   | 0x00000002 |                                 |                        |
|        | 2   | 0x00000004 |                                 |                        |
|        | 3   | 0x00000008 |                                 |                        |
| N1     | 4   | 0x00000010 | Gyro warm-up                    | 0 = Passed, 1 = Failed |
|        | 5   | 0x00000020 | Gyro self-test active           | 0 = Passed, 1 = Failed |
|        | 6   | 0x00000040 | Gyro status bit set             | 0 = Passed, 1 = Failed |
|        | 7   | 0x00000080 | Gyro time-out command interface | 0 = Passed, 1 = Failed |
| N2     | 8   | 0x00000100 | Power-up built-in test (PBIT)   | 0 = Passed, 1 = Failed |
|        | 9   | 0x00000200 | Reserved                        |                        |
|        | 10  | 0x00000400 | Interrupt                       | 0 = Passed, 1 = Failed |
|        | 11  | 0x00000800 | Reserved                        |                        |
| N3     | 12  | 0x00001000 | Warm-up                         | 0 = Passed, 1 = Failed |
|        | 13  | 0x00002000 | Reserved                        |                        |
|        | 14  | 0x00004000 |                                 |                        |
|        | 15  | 0x00008000 | Initiated built-in test (IBIT)  | 0 = Passed, 1 = Failed |
| N4     | 16  | 0x00010000 | Reserved                        |                        |
|        | 17  | 0x00020000 |                                 |                        |
|        | 18  | 0x00040000 | Accelerometer                   | 0 = Passed, 1 = Failed |
|        | 19  | 0x00080000 | Accelerometer time-out          | 0 = Passed, 1 = Failed |
| N5     | 20  | 0x00100000 | Reserved                        |                        |
|        | 21  | 0x00200000 | Gyro initiated BIT              | 0 = Passed, 1 = Failed |
|        | 22  | 0x00400000 | Gyro self-test                  | 0 = Passed, 1 = Failed |
|        | 23  | 0x00800000 | Gyro time-out                   | 0 = Passed, 1 = Failed |

| Nibble | Bit | Mask       | Description            | Range Value            |
|--------|-----|------------|------------------------|------------------------|
| N6     | 24  | 0x01000000 | Analog-to-Digital (AD) | 0 = Passed, 1 = Failed |
|        | 25  | 0x02000000 | Test mode              | 0 = Passed, 1 = Failed |
|        | 26  | 0x04000000 | Software               | 0 = Passed, 1 = Failed |
|        | 27  | 0x08000000 | RAM/ROM                | 0 = Passed, 1 = Failed |
| N7     | 28  | 0x10000000 | Reserved               |                        |
|        | 29  | 0x20000000 | Operational            | 0 = Passed, 1 = Failed |
|        | 30  | 0x40000000 | Interface              | 0 = Passed, 1 = Failed |
|        | 31  | 0x80000000 | Interface time-out     | 0 = Passed, 1 = Failed |

**Table 199: HG1700 IMU Status**

| Nibble | Bit | Mask       | Description | Range Value            |
|--------|-----|------------|-------------|------------------------|
| N0     | 0   | 0x00000001 | Reserved    |                        |
|        | 1   | 0x00000002 | Reserved    |                        |
|        | 2   | 0x00000004 | Reserved    |                        |
|        | 3   | 0x00000008 | Reserved    |                        |
| N1     | 4   | 0x00000010 | IMU Status  | 0 = Passed, 1 = Failed |
|        | 5   | 0x00000020 | IMU Status  | 0 = Passed, 1 = Failed |
|        | 6   | 0x00000040 | IMU Status  | 0 = Passed, 1 = Failed |
|        | 7   | 0x00000080 | IMU Status  | 0 = Passed, 1 = Failed |
| N2     | 8   | 0x00000100 | Reserved    |                        |
|        | 9   | 0x00000200 | Reserved    |                        |
|        | 10  | 0x00000400 | Reserved    |                        |
|        | 11  | 0x00000800 | Reserved    |                        |
| N3     | 12  | 0x00001000 | Reserved    |                        |
|        | 13  | 0x00002000 | Reserved    |                        |
|        | 14  | 0x00004000 | Reserved    |                        |
|        | 15  | 0x00008000 | Reserved    |                        |

| Nibble | Bit | Mask       | Description | Range Value            |
|--------|-----|------------|-------------|------------------------|
| N4     | 16  | 0x00010000 | Reserved    |                        |
|        | 17  | 0x00020000 | Reserved    |                        |
|        | 18  | 0x00040000 | Reserved    |                        |
|        | 19  | 0x00080000 | Reserved    |                        |
| N5     | 20  | 0x00100000 | Reserved    |                        |
|        | 21  | 0x00200000 | Reserved    |                        |
|        | 22  | 0x00400000 | Reserved    |                        |
|        | 23  | 0x00800000 | Reserved    |                        |
| N6     | 24  | 0x01000000 | Reserved    |                        |
|        | 25  | 0x02000000 | Reserved    |                        |
|        | 26  | 0x04000000 | Reserved    |                        |
|        | 27  | 0x08000000 | IMU Status  | 0 = Passed, 1= Failed  |
| N7     | 28  | 0x10000000 | IMU Status  | 0 = Passed, 1 = Failed |
|        | 29  | 0x20000000 | IMU Status  | 0 = Passed, 1 = Failed |
|        | 30  | 0x40000000 | IMU Status  | 0 = Passed, 1 = Failed |
|        | 31  | 0x80000000 | IMU Status  | 0 = Passed, 1 = Failed |

**Table 200: LN200 IMU Status**

| Nibble | Bit | Mask       | Description | Range Value            |
|--------|-----|------------|-------------|------------------------|
| N0     | 0   | 0x00000001 | IMU Status  | 0 = Passed, 1 = Failed |
|        | 1   | 0x00000002 | IMU Status  | 0 = Passed, 1 = Failed |
|        | 2   | 0x00000004 | IMU Status  | 0 = Passed, 1 = Failed |
|        | 3   | 0x00000008 | IMU Status  | 0 = Passed, 1 = Failed |
| N1     | 4   | 0x00000010 | IMU Status  | 0 = Passed, 1 = Failed |
|        | 5   | 0x00000020 | IMU Status  | 0 = Passed, 1 = Failed |
|        | 6   | 0x00000040 | IMU Status  | 0 = Passed, 1 = Failed |
|        | 7   | 0x00000080 | IMU Status  | 0 = Passed, 1 = Failed |

| Nibble | Bit | Mask       | Description | Range Value            |
|--------|-----|------------|-------------|------------------------|
| N2     | 8   | 0x00000100 | IMU Status  | 0 = Passed, 1 = Failed |
|        | 9   | 0x00000200 | IMU Status  | 0 = Passed, 1 = Failed |
|        | 10  | 0x00000400 | IMU Status  | 0 = Passed, 1 = Failed |
|        | 11  | 0x00000800 | IMU Status  | 0 = Passed, 1 = Failed |
| N3     | 12  | 0x00001000 | IMU Status  | 0 = Passed, 1 = Failed |
|        | 13  | 0x00002000 | IMU Status  | 0 = Passed, 1 = Failed |
|        | 14  | 0x00004000 | IMU Status  | 0 = Passed, 1 = Failed |
|        | 15  | 0x00008000 | Reserved    |                        |
| N4     | 16  | 0x00010000 | Reserved    |                        |
|        | 17  | 0x00020000 | Reserved    |                        |
|        | 18  | 0x00040000 | Reserved    |                        |
|        | 19  | 0x00080000 | Reserved    |                        |
| N5     | 20  | 0x00100000 | Reserved    |                        |
|        | 21  | 0x00200000 | Reserved    |                        |
|        | 22  | 0x00400000 | Reserved    |                        |
|        | 23  | 0x00800000 | Reserved    |                        |
| N6     | 24  | 0x01000000 | IMU Status  | 0 = Passed, 1 = Failed |
|        | 25  | 0x02000000 | IMU Status  | 0 = Passed, 1 = Failed |
|        | 26  | 0x04000000 | IMU Status  | 0 = Passed, 1 = Failed |
|        | 27  | 0x08000000 | IMU Status  | 0 = Passed, 1 = Failed |
| N7     | 28  | 0x10000000 | IMU Status  | 0 = Passed, 1 = Failed |
|        | 29  | 0x20000000 | Reserved    |                        |
|        | 30  | 0x40000000 | IMU Status  | 0 = Passed, 1 = Failed |
|        | 31  | 0x80000000 | Reserved    |                        |

**Table 201: ISA-100C IMU Status**

| Nibble | Bit | Mask       | Description             | Range Value   |
|--------|-----|------------|-------------------------|---|
| N0     | 0   | 0x00000001 | Maintenance Indication  | 0 = Normal,<br>1 = System Maintenance Indicator       |
|        | 1   | 0x00000002 | Accelerometers Invalid  | 0 = Normal, 1 = Invalid                               |
|        | 2   | 0x00000004 | Accelerometer X Warning | 0 = Normal, 1 = Warning                               |
|        | 3   | 0x00000008 | Accelerometer Y Warning | 0 = Normal, 1 = Warning                               |
| N1     | 4   | 0x00000010 | Accelerometer Z Warning | 0 = Normal, 1 = Warning                               |
|        | 5   | 0x00000020 | Accelerometer X NOGO    | 0 = Normal, 1 = NOGO                                  |
|        | 6   | 0x00000040 | Accelerometer Y NOGO    | 0 = Normal, 1 = NOGO                                  |
|        | 7   | 0x00000080 | Accelerometer Z NOGO    | 0 = Normal, 1 = NOGO                                  |
| N2     | 8   | 0x00000100 | Reset Occurred          | 0 = Normal,<br>1 = First Message after ISA-100C Reset |
|        | 9   | 0x00000200 | Gyroscopes Invalid      | 0 = Normal, 1 = Invalid                               |
|        | 10  | 0x00000400 | Gyroscope X Warning     | 0 = Normal, 1 = Warning                               |
|        | 11  | 0x00000800 | Gyroscope Y Warning     | 0 = Normal, 1 = Warning                               |
| N3     | 12  | 0x00001000 | Gyroscope Z Warning     | 0 = Normal, 1 = Warning                               |
|        | 13  | 0x00002000 | Gyroscope X NOGO        | 0 = Normal, 1 = NOGO                                  |
|        | 14  | 0x00004000 | Gyroscope Y NOGO        | 0 = Normal, 1 = NOGO                                  |
|        | 15  | 0x00008000 | Gyroscope Z NOGO        | 0 = Normal, 1 = NOGO                                  |

| Nibble | Bit | Mask       | Description  | Range Value |
|--------|-----|------------|--|-------------|
| N4     | 16  | 0x00010000 | IMU temperature reading as follows:<br>Signed 2-byte value (SHORT)<br>1 LSB = $3.90625e^{-3}$ Celsius<br>Temperature Range +/- 128 Celsius |             |
|        | 17  | 0x00020000 |  |             |
|        | 18  | 0x00040000 |  |             |
|        | 19  | 0x00080000 |  |             |
| N5     | 20  | 0x00100000 |  |             |
|        | 21  | 0x00200000 |  |             |
|        | 22  | 0x00400000 |  |             |
|        | 23  | 0x00800000 |  |             |
| N6     | 24  | 0x01000000 |  |             |
|        | 25  | 0x02000000 |  |             |
|        | 26  | 0x04000000 |  |             |
|        | 27  | 0x08000000 |  |             |
| N7     | 28  | 0x10000000 |  |             |
|        | 29  | 0x20000000 |  |             |
|        | 30  | 0x40000000 |  |             |
|        | 31  | 0x80000000 |  |             |

Table 202: IMU-CPT IMU Status

| Nibble | Bit | Mask       | Description            | Range Value            |
|--------|-----|------------|------------------------|------------------------|
| N0     | 0   | 0x00000001 | Gyro X Status          | 1 = Valid, 0 = Invalid |
|        | 1   | 0x00000002 | Gyro Y Status          | 1 = Valid, 0 = Invalid |
|        | 2   | 0x00000004 | Gyro Z Status          | 1 = Valid, 0 = Invalid |
|        | 3   | 0x00000008 | Unused                 | Set to 0               |
| N1     | 4   | 0x00000010 | Accelerometer X Status | 1 = Valid, 0 = Invalid |
|        | 5   | 0x00000020 | Accelerometer Y Status | 1 = Valid, 0 = Invalid |
|        | 6   | 0x00000040 | Accelerometer Z Status | 1 = Valid, 0 = Invalid |
|        | 7   | 0x00000080 | Unused                 | Set to 0               |

| Nibble | Bit | Mask       | Description  | Range Value |        |  |
|--------|-----|------------|--|-------------|--------|--|
| N2     | 8   | 0x00000100 | IMU Data Sequence Counter read in a Ushort.<br><b>Note:</b> Increments for each message and resets to 0 after 127. |             |        |  |
|        | 9   | 0x00000200 |  |             |        |  |
|        | 10  | 0x00000400 |  |             |        |  |
|        | 11  | 0x00000800 |  |             |        |  |
| N3     | 12  | 0x00001000 |  |             |        |  |
|        | 13  | 0x00002000 |  |             |        |  |
|        | 14  | 0x00004000 |  |             |        |  |
|        | 15  | 0x00008000 |  |             |        |  |
| N4     | 16  | 0x00010000 |  |             | Unused |  |
|        | 17  | 0x00020000 |  |             |        |  |
|        | 18  | 0x00040000 |  |             |        |  |
|        | 19  | 0x00080000 |  |             |        |  |
| N5     | 20  | 0x00100000 |  |             |        |  |
|        | 21  | 0x00200000 |  |             |        |  |
|        | 22  | 0x00400000 |  |             |        |  |
|        | 23  | 0x00800000 |  |             |        |  |
| N6     | 24  | 0x01000000 |  |             |        |  |
|        | 25  | 0x02000000 |  |             |        |  |
|        | 26  | 0x04000000 |  |             |        |  |
|        | 27  | 0x08000000 |  |             |        |  |
| N7     | 28  | 0x10000000 |  |             |        |  |
|        | 29  | 0x20000000 |  |             |        |  |
|        | 30  | 0x40000000 |  |             |        |  |
|        | 31  | 0x80000000 |  |             |        |  |

**Table 203: IMU-KVH1750 IMU Status**

| Nibble | Bit | Mask       | Description  | Range Value            |
|--------|-----|------------|--|------------------------|
| N0     | 0   | 0x00000001 | Gyro X Status  | 1 = Valid, 0 = Invalid |
|        | 1   | 0x00000002 | Gyro Y Status  | 1 = Valid, 0 = Invalid |
|        | 2   | 0x00000004 | Gyro Z Status  | 1 = Valid, 0 = Invalid |
|        | 3   | 0x00000008 | Unused   | Set to 0               |
| N1     | 4   | 0x00000010 | Accelerometer X Status   | 1 = Valid, 0 = Invalid |
|        | 5   | 0x00000020 | Accelerometer Y Status   | 1 = Valid, 0 = Invalid |
|        | 6   | 0x00000040 | Accelerometer Z Status   | 1 = Valid, 0 = Invalid |
|        | 7   | 0x00000080 | Unused   | Set to 0               |
| N2     | 8   | 0x00000100 | IMU Data Sequence Counter read in a Ushort.<br><b>Note:</b> Increments for each message and resets to 0 after 127. |                        |
|        | 9   | 0x00000200 |  |                        |
|        | 10  | 0x00000400 |  |                        |
|        | 11  | 0x00000800 |  |                        |
| N3     | 12  | 0x00001000 |  |                        |
|        | 13  | 0x00002000 |  |                        |
|        | 14  | 0x00004000 |  |                        |
|        | 15  | 0x00008000 |  |                        |



| Nibble | Bit | Mask       | Description   | Range Value |
|--------|-----|------------|---|-------------|
| N4     | 16  | 0x00010000 | IMU temperature reading as follows:<br>Signed 2-byte value (SHORT)<br>Rounded to the nearest degree   |             |
|        | 17  | 0x00020000 |   |             |
|        | 18  | 0x00040000 |   |             |
|        | 19  | 0x00080000 |   |             |
| N5     | 20  | 0x00100000 | Example:<br><RAWIMU COM1 0 75.0 FINESTEERING 1813 514207.000 00000020<br>fa9a 45836<br>1813 514207.0000000000 00260077 32164 -47 -305 1 -10 0 |             |
|        | 21  | 0x00200000 |   |             |
|        | 22  | 0x00400000 |   |             |
|        | 23  | 0x00800000 |   |             |
| N6     | 24  | 0x01000000 | IMU status = 00260077<br>Temperatures bytes = 0026<br>Decimal value = 38 degrees C  |             |
|        | 25  | 0x02000000 |   |             |
|        | 26  | 0x04000000 |   |             |
|        | 27  | 0x08000000 |   |             |
| N7     | 28  | 0x10000000 |   |             |
|        | 29  | 0x20000000 |   |             |
|        | 30  | 0x40000000 |   |             |
|        | 31  | 0x80000000 |   |             |

**Table 204: HG1900 and HG1930 IMU Status**

| Nibble | Bit | Mask       | Description | Range Value            |
|--------|-----|------------|-------------|------------------------|
| N0     | 0   | 0x00000001 | Reserved    |                        |
|        | 1   | 0x00000002 |             |                        |
|        | 2   | 0x00000004 |             |                        |
|        | 3   | 0x00000008 |             |                        |
| N1     | 4   | 0x00000010 | IMU Status  | 0 = Passed, 1 = Failed |
|        | 5   | 0x00000020 | IMU Status  | 0 = Passed, 1 = Failed |
|        | 6   | 0x00000040 | IMU Status  | 0 = Passed, 1 = Failed |
|        | 7   | 0x00000080 | IMU Status  | 0 = Passed, 1 = Failed |

| Nibble | Bit | Mask       | Description | Range Value            |
|--------|-----|------------|-------------|------------------------|
| N2     | 8   | 0x00000100 | Reserved    |                        |
|        | 9   | 0x00000200 |             |                        |
|        | 10  | 0x00000400 |             |                        |
|        | 11  | 0x00000800 |             |                        |
| N3     | 12  | 0x00001000 | Reserved    |                        |
|        | 13  | 0x00002000 |             |                        |
|        | 14  | 0x00004000 |             |                        |
|        | 15  | 0x00008000 |             |                        |
| N4     | 16  | 0x00010000 | Reserved    |                        |
|        | 17  | 0x00020000 |             |                        |
|        | 18  | 0x00040000 |             |                        |
|        | 19  | 0x00080000 |             |                        |
| N5     | 20  | 0x00100000 | Reserved    |                        |
|        | 21  | 0x00200000 |             |                        |
|        | 22  | 0x00400000 |             |                        |
|        | 23  | 0x00800000 |             |                        |
| N6     | 24  | 0x01000000 | IMU Status  | 0 = Passed, 1 = Failed |
|        | 25  | 0x02000000 | Reserved    |                        |
|        | 26  | 0x04000000 | IMU Status  | 0 = Passed, 1 = Failed |
|        | 27  | 0x08000000 | IMU Status  | 0 = Passed, 1 = Failed |
| N7     | 28  | 0x10000000 | IMU Status  | 0 = Passed, 1 = Failed |
|        | 29  | 0x20000000 | IMU Status  | 0 = Passed, 1 = Failed |
|        | 30  | 0x40000000 | IMU Status  | 0 = Passed, 1 = Failed |
|        | 31  | 0x80000000 | Reserved    |                        |

**Table 205: ADIS16488 and IMU-IGM-A1 IMU Status**

| Nibble | Bit | Mask       | Description                                 | Range Value  |
|--------|-----|------------|---|--|
| N0     | 0   | 0x00000001 | Alarm Status Flag                           |  |
|        | 1   | 0x00000002 | Reserved                                    |  |
|        | 2   | 0x00000004 |   |  |
|        | 3   | 0x00000008 | SPI Communication Error                     | 0 = Passed, 1 = Failed                                 |
| N1     | 4   | 0x00000010 | Sensor Over-Range                           | 0 = Passed,<br>1 = One of more sensors over-<br>ranged |
|        | 5   | 0x00000020 | Initial Self Test Failure                   | 0 = Passed, 1 = Failed                                 |
|        | 6   | 0x00000040 | Flash Memory Failure                        | 0 = Passed, 1 = Failed                                 |
|        | 7   | 0x00000080 | Processing Overrun                          | 0 = Passed, 1 = Failed                                 |
| N2     | 8   | 0x00000100 | Self Test Failure – X-axis gyro             | 0 = Passed, 1 = Failed                                 |
|        | 9   | 0x00000200 | Self Test Failure – Y-axis gyro             | 0 = Passed, 1 = Failed                                 |
|        | 10  | 0x00000400 | Self Test Failure – Z-axis gyro             | 0 = Passed, 1 = Failed                                 |
|        | 11  | 0x00000800 | Self Test Failure – X-axis<br>accelerometer | 0 = Passed, 1 = Failed                                 |
| N3     | 12  | 0x00001000 | Self Test Failure – Y-axis<br>accelerometer | 0 = Passed, 1 = Failed                                 |
|        | 13  | 0x00002000 | Self Test Failure – Z-axis                  | 0 = Passed, 1 = Failed                                 |
|        | 14  | 0x00004000 | Reserved                                    |  |
|        | 15  | 0x00008000 |   |  |

| Nibble | Bit | Mask       | Description  | Range Value |
|--------|-----|------------|--|-------------|
| N4     | 16  | 0x00010000 | IMU temperature reading as follows:<br>Signed 2-byte value (SHORT)<br>25°C = 0x0000<br>1 LSB = 0.00565°C |             |
|        | 17  | 0x00020000 |  |             |
|        | 18  | 0x00040000 |  |             |
|        | 19  | 0x00080000 |  |             |
| N5     | 20  | 0x00100000 |  |             |
|        | 21  | 0x00200000 |  |             |
|        | 22  | 0x00400000 |  |             |
|        | 23  | 0x00800000 |  |             |
| N6     | 24  | 0x01000000 |  |             |
|        | 25  | 0x02000000 |  |             |
|        | 26  | 0x04000000 |  |             |
|        | 27  | 0x08000000 |  |             |
| N7     | 28  | 0x10000000 |  |             |
|        | 29  | 0x20000000 |  |             |
|        | 30  | 0x40000000 |  |             |
|        | 31  | 0x80000000 |  |             |

**Table 206: STIM300 and IMU-IGM-S1 IMU Status**

| Nibble | Bit | Mask       | Description          | Range Value  |
|--------|-----|------------|----------------------|--|
| N0     | 0   | 0x00000001 | Gyro status          | 0 = OK, 1 = X-channel  |
|        | 1   | 0x00000002 |                      | 0 = OK, 1 = Y-channel  |
|        | 2   | 0x00000004 |                      | 0 = OK, 1 = Z-channel  |
|        | 3   | 0x00000008 |                      | 0 = OK, 1 = Error in measurement channel<br>(Bits 0-2 flag the error channels) |
| N1     | 4   | 0x00000010 |                      | 0 = OK, 1 = Overload<br>(Bits 0-2 flag the error channels)                     |
|        | 5   | 0x00000020 |                      | 0 = OK, 1 = Outside operating conditions                                       |
|        | 6   | 0x00000040 |                      | 0 = OK, 1 = Startup  |
|        | 7   | 0x00000080 |                      | 0 = OK, 1 = System integrity error   |
| N2     | 8   | 0x00000100 | Accelerometer Status | 0 = OK, 1 = X-channel  |
|        | 9   | 0x00000200 |                      | 0 = OK, 1 = Y-channel  |
|        | 10  | 0x00000400 |                      | 0 = OK, 1 = Z-channel  |
|        | 11  | 0x00000800 |                      | 0 = OK, 1 = Error in measurement channel<br>(Bits 0-2 flag the error channels) |
| N3     | 12  | 0x00001000 |                      | 0 = OK, 1 = Overload<br>(Bits 0-2 flag the error channels)                     |
|        | 13  | 0x00002000 |                      | 0 = OK, 1 = Outside operating conditions                                       |
|        | 14  | 0x00004000 |                      | 0 = OK, 1 = Startup  |
|        | 15  | 0x00008000 |                      | 0 = OK, 1 = System integrity error   |

| Nibble | Bit | Mask       | Description  | Range Value |
|--------|-----|------------|--|-------------|
| N4     | 16  | 0x00010000 | Temperature of the X gyro sensor<br>0°C = 0x0000<br>1 LSB = 2 <sup>-8</sup> °C |             |
|        | 17  | 0x00020000 |  |             |
|        | 18  | 0x00040000 |  |             |
|        | 19  | 0x00080000 |  |             |
| N5     | 20  | 0x00100000 |  |             |
|        | 21  | 0x00200000 |  |             |
|        | 22  | 0x00400000 |  |             |
|        | 23  | 0x00800000 |  |             |
| N6     | 24  | 0x01000000 |  |             |
|        | 25  | 0x02000000 |  |             |
|        | 26  | 0x04000000 |  |             |
|        | 27  | 0x08000000 |  |             |
| N7     | 28  | 0x10000000 |  |             |
|        | 29  | 0x20000000 |  |             |
|        | 30  | 0x40000000 |  |             |
|        | 31  | 0x80000000 |  |             |

Table 207:  $\mu$ IMU IMU Status

| Nibble | Bit | Mask       | Description           | Range Value                     |
|--------|-----|------------|-----------------------|---------------------------------|
| N0     | 0   | 0x00000001 | Reset Acknowledged    | 0 = Normal, 1 = Reset           |
|        | 1   | 0x00000002 | Gyros Not Initialized | 0 = Normal, 1 = Not Initialized |
|        | 2   | 0x00000004 | Gyro X Warning        | 0 = Normal, 1 = Warning         |
|        | 3   | 0x00000008 | Gyro Y Warning        | 0 = Normal, 1 = Warning         |
| N1     | 4   | 0x00000010 | Gyro Z Warning        | 0 = Normal, 1 = Warning         |
|        | 5   | 0x00000020 | Gyro X NOGO           | 0 = Normal, 1 = NOGO            |
|        | 6   | 0x00000040 | Gyro Y NOGO           | 0 = Normal, 1 = NOGO            |
|        | 7   | 0x00000080 | Gyro Z NOGO           | 0 = Normal, 1 = NOGO            |

| Nibble | Bit | Mask       | Description  | Range Value                     |
|--------|-----|------------|--|---------------------------------|
| N2     | 8   | 0x00000100 | Reserved   |                                 |
|        | 9   | 0x00000200 | Accels Not Initialized   | 0 = Normal, 1 = Not Initialized |
|        | 10  | 0x00000400 | Accel X Warning  | 0 = Normal, 1 = Warning         |
|        | 11  | 0x00000800 | Accel Y Warning  | 0 = Normal, 1 = Warning         |
| N3     | 12  | 0x00001000 | Accel Z Warning  | 0 = Normal, 1 = Warning         |
|        | 13  | 0x00002000 | Accel X NOGO   | 0 = Normal, 1 = NOGO            |
|        | 14  | 0x00004000 | Accel Y NOGO   | 0 = Normal, 1 = NOGO            |
|        | 15  | 0x00008000 | Accel Z NOGO   | 0 = Normal, 1 = NOGO            |
| N4     | 16  | 0x00010000 | IMU temperature reading as follows:<br>Signed 2-byte value (SHORT)<br>1 LSB = $3.90625e^{-3}$ °C<br>Temperature Range +/- 128 °C |                                 |
|        | 17  | 0x00020000 |  |                                 |
|        | 18  | 0x00040000 |  |                                 |
|        | 19  | 0x00080000 |  |                                 |
| N5     | 20  | 0x00100000 |  |                                 |
|        | 21  | 0x00200000 |  |                                 |
|        | 22  | 0x00400000 |  |                                 |
|        | 23  | 0x00800000 |  |                                 |
| N6     | 24  | 0x01000000 |  |                                 |
|        | 25  | 0x02000000 |  |                                 |
|        | 26  | 0x04000000 |  |                                 |
|        | 27  | 0x08000000 |  |                                 |
| N7     | 28  | 0x10000000 |  |                                 |
|        | 29  | 0x20000000 |  |                                 |
|        | 30  | 0x40000000 |  |                                 |
|        | 31  | 0x80000000 |  |                                 |

**Table 208: G320N IMU Status**

| Nibble | Bit | Mask       | Description            | Range Value                    |  |  |                    |                           |
|--------|-----|------------|------------------------|--------------------------------|--|--|--------------------|---------------------------|
| N0     | 0   | 0x00000001 | Error All              | 0 = Normal, 1 = Sensor Failure |  |  |                    |                           |
|        | 1   | 0x00000002 | Reserved               |                                |  |  |                    |                           |
|        | 2   | 0x00000004 |                        |                                |  |  |                    |                           |
|        | 3   | 0x00000008 |                        |                                |  |  |                    |                           |
| N1     | 4   | 0x00000010 |                        |                                |  |  |                    |                           |
|        | 5   | 0x00000020 |                        |                                |  |  |                    |                           |
|        | 6   | 0x00000040 |                        |                                |  |  |                    |                           |
|        | 7   | 0x00000080 |                        |                                |  |  |                    |                           |
| N2     | 8   | 0x00000100 |                        |                                |  |  |                    |                           |
|        | 9   | 0x00000200 |                        |                                |  |  | Accel Z - New Data | New Data = 1, No Data = 0 |
|        | 10  | 0x00000400 |                        |                                |  |  | Accel Y - New Data | New Data = 1, No Data = 0 |
|        | 11  | 0x00000800 |                        |                                |  |  | Accel X - New Data | New Data = 1, No Data = 0 |
| N3     | 12  | 0x00001000 | Gyro Z - New Data      | New Data = 1, No Data = 0      |  |  |                    |                           |
|        | 13  | 0x00002000 | Gyro Y - New Data      | New Data = 1, No Data = 0      |  |  |                    |                           |
|        | 14  | 0x00004000 | Gyro X - New Data      | New Data = 1, No Data = 0      |  |  |                    |                           |
|        | 15  | 0x00008000 | Temperature - New Data | New Data = 1, No Data = 0      |  |  |                    |                           |



| Nibble | Bit | Mask       | Description   | Range Value |
|--------|-----|------------|---|-------------|
| N4     | 16  | 0x00010000 | IMU Temperature reading as follows:<br>$\text{Temperature} = [(-0.0037918 * (A - 2634)) + 25]$ Celsius<br>A: Temperature Sensor output data (decimal) |             |
|        | 17  | 0x00020000 |   |             |
|        | 18  | 0x00040000 |   |             |
|        | 19  | 0x00080000 |   |             |
| N5     | 20  | 0x00100000 |   |             |
|        | 21  | 0x00200000 |   |             |
|        | 22  | 0x00400000 |   |             |
|        | 23  | 0x00800000 |   |             |
| N6     | 24  | 0x01000000 |   |             |
|        | 25  | 0x02000000 |   |             |
|        | 26  | 0x04000000 |   |             |
|        | 27  | 0x08000000 |   |             |
| N7     | 28  | 0x10000000 |   |             |
|        | 29  | 0x20000000 |   |             |
|        | 30  | 0x40000000 |   |             |
|        | 31  | 0x80000000 |   |             |

## 5.36 RAWIMUS

### *Short Raw IMU Data*

**Platform:** OEM719, OEM729, OEM7500, OEM7700, OEM7720, PwrPak7, HxGN PIM7500

This log is the short header version of the **RAWIMU** log (see page 965).

**Message ID:** 325

**Log Type:** Asynch

**Recommended Input:**

```
log rawimusa onnew
```

**ASCII Example:**

```
%RAWIMUSA,1105,425384.180;1105,425384.156166800,111607,43088060,430312,-3033352,-132863,186983,823*5aa97065
```

| Field | Field Type        | Description  | Format | Binary Bytes | Binary Offset |
|-------|-------------------|--|--------|--------------|---------------|
| 1     | RAWIMUS Header    | Log header. See <i>Messages</i> on page 25 for more information. | -      | H            | 0             |
| 2     | Week              | GNSS Week  | Ulong  | 4            | H             |
| 3     | Seconds into Week | Seconds from week start  | Double | 8            | H+4           |

| Field | Field Type     | Description   | Format       | Binary Bytes | Binary Offset |
|-------|----------------|---|--------------|--------------|---------------|
| 4     | IMU Status     | <p>The status of the IMU. This field is given in a fixed length (n) array of bytes in binary but in ASCII or Abbreviated ASCII is converted into 2 character hexadecimal pairs.</p> <p>For the raw IMU status, see one of the following tables:</p> <ul style="list-style-type: none"> <li>• <i>Table 198: iIMU-FSAS IMU Status</i> on page 969</li> <li>• <i>Table 199: HG1700 IMU Status</i> on page 970</li> <li>• <i>Table 200: LN200 IMU Status</i> on page 971</li> <li>• <i>Table 201: ISA-100C IMU Status</i> on page 973</li> <li>• <i>Table 202: IMU-CPT IMU Status</i> on page 974</li> <li>• <i>Table 203: IMU-KVH1750 IMU Status</i> on page 976</li> <li>• <i>Table 204: HG1900 and HG1930 IMU Status</i> on page 977</li> <li>• <i>Table 205: ADIS16488 and IMU-IGM-A1 IMU Status</i> on page 979</li> <li>• <i>Table 206: STIM300 and IMU-IGM-S1 IMU Status</i> on page 981</li> <li>• <i>Table 207: <math>\mu</math>IMU IMU Status</i> on page 982</li> <li>• <i>Table 208: G320N IMU Status</i> on page 984</li> </ul> <p>Also refer to Interface Control Documentation as provided by Honeywell or Northrop Grumman.</p> | Hex<br>Ulong | 4            | H+12          |
| 5     | Z Accel Output | <p>Change in velocity count along z axis</p> <p>The change in velocity (acceleration) scale factor for each IMU type can be found in <i>Table 209: Raw IMU Scale Factors</i> on page 990. Multiply the scale factor in <i>Table 209: Raw IMU Scale Factors</i> on page 990 by the count in this field for the velocity increments.</p>  | Long         | 4            | H+16          |

| Field | Field Type         | Description  | Format | Binary Bytes | Binary Offset |
|-------|--------------------|--|--------|--------------|---------------|
| 6     | - (Y Accel Output) | <p>- (Change in velocity count along y axis)</p> <p>The change in velocity (acceleration) scale factor for each IMU type can be found in <i>Table 209: Raw IMU Scale Factors</i> on page 990. Multiply the scale factor in <i>Table 209: Raw IMU Scale Factors</i> on page 990 by the count in this field for the velocity increments.</p> <p>A negative value implies the output is along the positive y-axis marked on the IMU. A positive value implies the change is in the direction opposite to that of the y-axis marked on the IMU.</p>  | Long   | 4            | H+20          |
| 7     | X Accel Output     | <p>Change in velocity count along x axis</p> <p>The change in velocity (acceleration) scale factor for each IMU type can be found in <i>Table 209: Raw IMU Scale Factors</i> on page 990. Multiply the scale factor in <i>Table 209: Raw IMU Scale Factors</i> on page 990 by the count in this field for the velocity increments.</p>   | Long   | 4            | H+24          |
| 8     | Z Gyro Output      | <p>Change in angle count around z axis<br/>Right-handed</p> <p>The change in angle (gyro) scale factor can be found in <i>Table 209: Raw IMU Scale Factors</i> on page 990. Multiply the appropriate scale factor in <i>Table 209: Raw IMU Scale Factors</i> on page 990 by the count in this field for the angle increments in radians.</p> <p>To obtain acceleration in <math>m/s^2</math>, multiply the velocity increments by the output rate of the IMU (e.g., 100 Hz for HG1700, HG1900 and HG1930; 200 Hz for ISA-100C, iMAR-FSAS, LN200, KVH1750 and ADIS16488; 125 Hz for STIM300 and G320N).</p> | Long   | 4            | H+28          |

| Field | Field Type        | Description   | Format | Binary Bytes | Binary Offset |
|-------|-------------------|---|--------|--------------|---------------|
| 9     | - (Y Gyro Output) | <p>- (Change in angle count around y axis)<br/>Right-handed</p> <p>The change in angle (gyro) scale factor can be found in <i>Table 209: Raw IMU Scale Factors</i> on the next page. Multiply the appropriate scale factor in <i>Table 209: Raw IMU Scale Factors</i> on the next page by the count in this field for the angle increments in radians.</p> <p>To obtain acceleration in <math>m/s^2</math>, multiply the velocity increments by the output rate of the IMU (e.g., 100 Hz for HG1700, HG1900 and HG1930; 200 Hz for ISA-100C, iMAR-FSAS, LN200, KVH1750 and ADIS16488; 125 Hz for STIM300 and G320N).</p> <p>A negative value implies the output is along the positive y-axis marked on the IMU. A positive value implies the change is in the direction opposite to that of the y-axis marked on the IMU.</p> | Long   | 4            | H+32          |
| 10    | X Gyro Output     | <p>Change in angle count around x axis<br/>Right-handed</p> <p>The change in angle (gyro) scale factor can be found in <i>Table 209: Raw IMU Scale Factors</i> on the next page. Multiply the appropriate scale factor in <i>Table 209: Raw IMU Scale Factors</i> on the next page by the count in this field for the angle increments in radians.</p> <p>To obtain acceleration in <math>m/s^2</math>, multiply the velocity increments by the output rate of the IMU (e.g., 100 Hz for HG1700, HG1900 and HG1930; 200 Hz for ISA-100C, iMAR-FSAS, LN200, KVH1750 and ADIS16488; 125 Hz for STIM300 and G320N).</p>  | Long   | 4            | H+36          |
| 11    | xxxx              | 32-bit CRC (ASCII, Binary and Short Binary only)  | Hex    | 4            | H+40          |
| 12    | [CR][LF]          | Sentence terminator (ASCII only)  | -      | -            | -             |

**Table 209: Raw IMU Scale Factors**

|  | <b>Gyroscope Scale Factor</b>         | <b>Acceleration Scale Factor</b>            |
|--|---------------------------------------|---|
| <b>HG1700-AG58</b><br><b>HG1900-CA29/CA50</b><br><b>HG1930-AA99/CA50</b> | $2.0^{-33}$ rad/LSB                   | $2.0^{-27}$ ft/s/LSB                        |
| <b>HG1700-AG62</b>   | $2.0^{-33}$ rad/LSB                   | $2.0^{-26}$ ft/s/LSB                        |
| <b>IMU-CPT</b><br><b>IMU-KVH1750</b>                                     | $0.1 / (3600.0 \times 256.0)$ rad/LSB | $0.05 / 2^{15}$ m/s/LSB                     |
| <b>IMU-FSAS</b>  | $0.1 \times 2^{-8}$ arcsec/LSB        | $0.05 \times 2^{-15}$ m/s/LSB               |
| <b>LN-200</b>  | $2^{-19}$ rad/LSB                     | $2^{-14}$ m/s/LSB                           |
| <b>ISA-100C</b><br><b>μIMU</b>   | $1.0 \times 10^{-9}$ rad/LSB          | $2.0 \times 10^{-8}$ m/s/LSB                |
| <b>ADIS16488</b><br><b>IMU-IGM-A1</b>                                    | $720 / 2^{31}$ deg/LSB                | $200 / 2^{31}$ m/s/LSB                      |
| <b>STIM300</b><br><b>IMU-IGM-S1</b>                                      | $2^{-21}$ deg/LSB                     | $2^{-22}$ m/s/LSB                           |
| <b>G320N</b>   | $(0.008 / 65536) / 125$ deg/s/LSB     | $(0.200 / 65536) / 125$ mG/LSB <sup>1</sup> |

<sup>1</sup> 1 G = 9.8065 m/s<sup>2</sup>

## 5.37 RAWIMUSX

### *IMU Data Extended*

**Platform: OEM719, OEM729, OEM7500, OEM7700, OEM7720, PwrPak7, HxGN PIM7500**

This is the short header version of the extended RAWIMUX log intended for use with post-processing. The extended version includes IMU information that is used by the NovAtel Inertial Explorer post-processing software.

**Message ID: 1462**

**Log Type: Asynch**

**Recommended Input:**

```
log rawimusxb onnew
```

**ASCII example:**

```
%RAWIMUSXA,1692,484620.664;00,11,1692,484620.664389000,00801503,43110635,-817242,-202184,-215194,-41188,-9895*a5db8c7b
```

| Field | Field Type        | Description   | Format | Binary Bytes | Binary Offset |
|-------|-------------------|---|--------|--------------|---------------|
| 1     | RAWIMUSX Header   | Log header. See <i>Messages</i> on page 25 for more information. (short)  | -      | H            | 0             |
| 2     | IMU Error         | Simple IMU error flag.<br>01 = IMU error<br>00 = IMU okay.<br>If there is an IMU error, check the IMU Status field for details.<br>This field is output as a Hex value. | Uchar  | 1            | H             |
| 3     | IMU Type          | IMU Type identifier.<br>See <i>Table 182: IMU Type</i> on page 846.   | Uchar  | 1            | H+1           |
| 4     | GNSS Week         | GNSS Week   | Ushort | 2            | H+2           |
| 5     | GNSS Week Seconds | Seconds from week start   | Double | 8            | H+4           |

| Field | Field Type | Description   | Format       | Binary Bytes | Binary Offset |
|-------|------------|---|--------------|--------------|---------------|
| 6     | IMU Status | <p>The status of the IMU. This field is given in a fixed length (n) array of bytes in binary but in ASCII or Abbreviated ASCII is converted into 2 character hexadecimal pairs.</p> <p>For the raw IMU status, see one of the following tables:</p> <ul style="list-style-type: none"> <li>• <i>Table 198: iIMU-FSAS IMU Status</i> on page 969</li> <li>• <i>Table 199: HG1700 IMU Status</i> on page 970</li> <li>• <i>Table 200: LN200 IMU Status</i> on page 971</li> <li>• <i>Table 201: ISA-100C IMU Status</i> on page 973</li> <li>• <i>Table 202: IMU-CPT IMU Status</i> on page 974</li> <li>• <i>Table 203: IMU-KVH1750 IMU Status</i> on page 976</li> <li>• <i>Table 204: HG1900 and HG1930 IMU Status</i> on page 977</li> <li>• <i>Table 205: ADIS16488 and IMU-IGM-A1 IMU Status</i> on page 979</li> <li>• <i>Table 206: STIM300 and IMU-IGM-S1 IMU Status</i> on page 981</li> <li>• <i>Table 207: <math>\mu</math>IMU IMU Status</i> on page 982</li> <li>• <i>Table 208: G320N IMU Status</i> on page 984</li> </ul> <p>Also refer to Interface Control Documentation as provided by Honeywell or Northrop Grumman.</p> | Hex<br>Ulong | 4            | H+12          |
| 7     | Z Accel    | <p>Change in velocity count along Z-axis.</p> <p>The change in velocity (acceleration) scale factor for each IMU type can be found in <i>Table 209: Raw IMU Scale Factors</i> on page 990. Multiply the scale factor in <i>Table 209: Raw IMU Scale Factors</i> on page 990 by the count in this field for the velocity increments.</p>   | Long         | 4            | H+16          |



| Field | Field Type | Description   | Format | Binary Bytes | Binary Offset |
|-------|------------|---|--------|--------------|---------------|
| 8     | -(Y Accel) | <p>- (Change in velocity count along y-axis.)</p> <p>The change in velocity (acceleration) scale factor for each IMU type can be found in <i>Table 209: Raw IMU Scale Factors</i> on page 990. Multiply the scale factor in <i>Table 209: Raw IMU Scale Factors</i> on page 990 by the count in this field for the velocity increments.</p> <p>A negative value implies the output is along the positive y-axis marked on the IMU. A positive value implies the change is in the direction opposite to that of the y-axis marked on the IMU.</p>  | Long   | 4            | H+20          |
| 9     | X Accel    | <p>Change in velocity count along x axis.</p> <p>The change in velocity (acceleration) scale factor for each IMU type can be found in <i>Table 209: Raw IMU Scale Factors</i> on page 990. Multiply the scale factor in <i>Table 209: Raw IMU Scale Factors</i> on page 990 by the count in this field for the velocity increments.</p>   | Long   | 4            | H+24          |
| 10    | Z Gyro     | <p>Change in angle count around z axis.<br/>Right-handed</p> <p>The change in angle (gyro) scale factor can be found in <i>Table 209: Raw IMU Scale Factors</i> on page 990. Multiply the appropriate scale factor in <i>Table 209: Raw IMU Scale Factors</i> on page 990 by the count in this field for the angle increments in radians.</p> <p>To obtain acceleration in <math>m/s^2</math>, multiply the velocity increments by the output rate of the IMU (e.g., 100 Hz for HG1700, HG1900 and HG1930; 200 Hz for ISA-100C, iMAR-FSAS, LN200, KVH1750 and ADIS16488; 125 Hz for STIM300 and G320N).</p> | Long   | 4            | H+28          |

| Field | Field Type | Description  | Format | Binary Bytes | Binary Offset |
|-------|------------|--|--------|--------------|---------------|
| 11    | -(Y Gyro)  | <p>- (Change in angle count around y axis.)<br/>Right-handed</p> <p>The change in angle (gyro) scale factor can be found in <i>Table 209: Raw IMU Scale Factors</i> on page 990. Multiply the appropriate scale factor in <i>Table 209: Raw IMU Scale Factors</i> on page 990 by the count in this field for the angle increments in radians.</p> <p>To obtain acceleration in <math>m/s^2</math>, multiply the velocity increments by the output rate of the IMU (e.g., 100 Hz for HG1700, HG1900 and HG1930; 200 Hz for ISA-100C, iMAR-FSAS, LN200, KVH1750 and ADIS16488; 125 Hz for STIM300 and G320N).</p> <p>A negative value implies the output is along the positive y-axis marked on the IMU. A positive value implies the change is in the direction opposite to that of the y-axis marked on the IMU.</p> | Long   | 4            | H+32          |
| 12    | X Gyro     | <p>Change in angle count around x axis.<br/>Right-handed</p> <p>The change in angle (gyro) scale factor can be found in <i>Table 209: Raw IMU Scale Factors</i> on page 990. Multiply the appropriate scale factor in <i>Table 209: Raw IMU Scale Factors</i> on page 990 by the count in this field for the angle increments in radians.</p> <p>To obtain acceleration in <math>m/s^2</math>, multiply the velocity increments by the output rate of the IMU (e.g., 100 Hz for HG1700, HG1900 and HG1930; 200 Hz for ISA-100C, iMAR-FSAS, LN200, KVH1750 and ADIS16488; 125 Hz for STIM300 and G320N).</p>  | Long   | 4            | H+36          |
| 13    | XXXX       | 32-bit CRC (ASCII, Binary, and Short Binary only)  | Hex    | 4            | H+40          |
| 14    | [CR][LF]   | Sentence terminator (ASCII only)   | -      | -            | -             |

## 5.38 RAWIMUX

### *IMU Data Extended*

**Platform: OEM719, OEM729, OEM7500, OEM7700, OEM7720, PwrPak7, HxGN PIM7500**

This log is an extended version of the RAWIMU log intended for use with post-processing. The extended version includes IMU information that is used by the NovAtel Inertial Explorer post-processing software.

**Message ID: 1461**

**Log Type: Asynch**

**Recommended Input:**

```
log rawimuxb onnew
```

**ASCII example:**

```
#RAWIMUXA,COM1,0,81.5,FINESTEERING,1691,410338.819,024c0020,3fd1,43495;00,5,1691,410338.818721000,00170705,-113836,-464281,43146813,89,11346,181*01cd06bf
```

| Field | Field Type        | Description   | Format | Binary Bytes | Binary Offset |
|-------|-------------------|---|--------|--------------|---------------|
| 1     | RAWIMUX Header    | Log header. See <i>Messages</i> on page 25 for more information.  | -      | H            | 0             |
| 2     | IMU Error         | Simple IMU error flag.<br>01 = IMU error<br>00 = IMU okay.<br>If there is an IMU error, check the IMU Status field for details.<br>This field is output as a Hex value. | Uchar  | 1            | H             |
| 3     | IMU Type          | IMU Type identifier.<br>See <i>Table 182: IMU Type</i> on page 846.   | Uchar  | 1            | H+1           |
| 4     | GNSS Week         | GNSS Week   | Ushort | 2            | H+2           |
| 5     | GNSS Week Seconds | Seconds from week start   | Double | 8            | H+4           |

| Field | Field Type | Description   | Format       | Binary Bytes | Binary Offset |
|-------|------------|---|--------------|--------------|---------------|
| 6     | IMU Status | <p>The status of the IMU. This field is given in a fixed length (n) array of bytes in binary but in ASCII or Abbreviated ASCII is converted into 2 character hexadecimal pairs.</p> <p>For the raw IMU status, see one of the following tables:</p> <ul style="list-style-type: none"> <li>• <i>Table 198: iIMU-FSAS IMU Status</i> on page 969</li> <li>• <i>Table 199: HG1700 IMU Status</i> on page 970</li> <li>• <i>Table 200: LN200 IMU Status</i> on page 971</li> <li>• <i>Table 201: ISA-100C IMU Status</i> on page 973</li> <li>• <i>Table 202: IMU-CPT IMU Status</i> on page 974</li> <li>• <i>Table 203: IMU-KVH1750 IMU Status</i> on page 976</li> <li>• <i>Table 204: HG1900 and HG1930 IMU Status</i> on page 977</li> <li>• <i>Table 205: ADIS16488 and IMU-IGM-A1 IMU Status</i> on page 979</li> <li>• <i>Table 206: STIM300 and IMU-IGM-S1 IMU Status</i> on page 981</li> <li>• <i>Table 207: <math>\mu</math>IMU IMU Status</i> on page 982</li> <li>• <i>Table 208: G320N IMU Status</i> on page 984</li> </ul> <p>Also refer to Interface Control Documentation as provided by Honeywell or Northrop Grumman.</p> | Hex<br>Ulong | 4            | H+12          |
| 7     | Z Accel    | <p>Change in velocity count along Z-axis.</p> <p>The change in velocity (acceleration) scale factor for each IMU type can be found in <i>Table 209: Raw IMU Scale Factors</i> on page 990. Multiply the scale factor in <i>Table 209: Raw IMU Scale Factors</i> on page 990 by the count in this field for the velocity increments.</p>   | Long         | 4            | H+16          |

| Field | Field Type | Description  | Format | Binary Bytes | Binary Offset |
|-------|------------|--|--------|--------------|---------------|
| 8     | -(Y Accel) | <p>- (Change in velocity count along y-axis.)</p> <p>The change in velocity (acceleration) scale factor for each IMU type can be found in <i>Table 209: Raw IMU Scale Factors</i> on page 990. Multiply the scale factor in <i>Table 209: Raw IMU Scale Factors</i> on page 990 by the count in this field for the velocity increments.</p> <p>A negative value implies the output is along the positive y-axis marked on the IMU. A positive value implies the change is in the direction opposite to that of the y-axis marked on the IMU.</p>   | Long   | 4            | H+20          |
| 9     | X Accel    | <p>Change in velocity count along x axis.</p> <p>The change in velocity (acceleration) scale factor for each IMU type can be found in <i>Table 209: Raw IMU Scale Factors</i> on page 990. Multiply the scale factor in <i>Table 209: Raw IMU Scale Factors</i> on page 990 by the count in this field for the velocity increments.</p>  | Long   | 4            | H+24          |
| 10    | Z Gyro     | <p>Change in angle count around z axis.<br/>Right-handed</p> <p>The change in angle (gyro) scale factor can be found in <i>Table 209: Raw IMU Scale Factors</i> on page 990. Multiply the appropriate scale factor in <i>Table 209: Raw IMU Scale Factors</i> on page 990, by the count in this field for the angle increments in radians.</p> <p>To obtain acceleration in <math>m/s^2</math>, multiply the velocity increments by the output rate of the IMU (e.g., 100 Hz for HG1700, HG1900 and HG1930; 200 Hz for ISA-100C, iMAR-FSAS, LN200, KVH1750 and ADIS16488; 125 Hz for STIM300 and G320N).</p> | Long   | 4            | H+28          |

| Field | Field Type | Description   | Format | Binary Bytes | Binary Offset |
|-------|------------|---|--------|--------------|---------------|
| 11    | -(Y Gyro)  | <p>- (Change in angle count around y axis.)<br/>Right-handed</p> <p>The change in angle (gyro) scale factor can be found in <i>Table 209: Raw IMU Scale Factors</i> on page 990. Multiply the appropriate scale factor in <i>Table 209: Raw IMU Scale Factors</i> on page 990, by the count in this field for the angle increments in radians.</p> <p>To obtain acceleration in <math>m/s^2</math>, multiply the velocity increments by the output rate of the IMU (e.g., 100 Hz for HG1700, HG1900 and HG1930; 200 Hz for ISA-100C, iMAR-FSAS, LN200, KVH1750 and ADIS16488; 125 Hz for STIM300 and G320N).</p> <p>A negative value implies the output is along the positive y-axis marked on the IMU. A positive value implies the change is in the direction opposite to that of the y-axis marked on the IMU.</p> | Long   | 4            | H+32          |
| 12    | X Gyro     | <p>Change in angle count around x axis.<br/>Right-handed</p> <p>The change in angle (gyro) scale factor can be found in <i>Table 209: Raw IMU Scale Factors</i> on page 990. Multiply the appropriate scale factor in <i>Table 209: Raw IMU Scale Factors</i> on page 990, by the count in this field for the angle increments in radians.</p> <p>To obtain acceleration in <math>m/s^2</math>, multiply the velocity increments by the output rate of the IMU (e.g., 100 Hz for HG1700, HG1900 and HG1930; 200 Hz for ISA-100C, iMAR-FSAS, LN200, KVH1750 and ADIS16488; 125 Hz for STIM300 and G320N).</p>  | Long   | 4            | H+36          |
| 13    | XXXX       | 32-bit CRC (ASCII, Binary, and Short Binary only)   | Hex    | 4            | H+40          |
| 14    | [CR][LF]   | Sentence terminator (ASCII only)  | -      | -            | -             |

## 5.39 RELINSPVA

### *Relative INSPVA log*

**Platform: OEM719, OEM729, OEM7500, OEM7700, OEM7720, PwrPak7, HxGN PIM7500**

This log provides the relative offset between the Master and Rover Inertial Solutions. The output solution provides the offset of where the local station is with respect to the other station.

**Message ID: 1446**

**Log Type: Asynch**

**Recommended Input:**

```
LOG RELINSPVAA ONNEW
```

**ASCII example:**

```
#RELINSPVAA,COM1,0,61.0,FINESTEERING,1805,245074.000,02000000,2338,457
57;BODY,9.285958662,-0.755483058,0.079229338,0.001739020,-
0.000126304,0.001525848,0.321033045,0.669367786,4.466250181,0.00000000
0,"b81V",INS_ALIGNMENT_COMPLETE,"B20C",INS_ALIGNMENT_COMPLETE,NARROW_
INT,00000000*a114ce3c
```

| Field | Field Type       | Description   | Format | Binary Bytes | Binary Offset |
|-------|------------------|---|--------|--------------|---------------|
| 1     | RELINSPVA Header | Log header. See <i>Messages</i> on page 25 for more information.  | -      | H            | 0             |
| 2     | Output Frame     | The current output frame (IMU body, ECEF or local level frame).<br>The output frame is specified using the <b>SETRELINSOUTPUTFRAME</b> command (see page 885)   | Enum   | 4            | H             |
| 3     | DeltaPosX        | Difference in the position between the two receivers (m).<br>The position difference is relative to the output frame:<br>BODY = along the X-axis<br>ECEF = along the X-axis<br>Local level = Northing | Double | 8            | H+4           |

| Field | Field Type | Description  | Format | Binary Bytes | Binary Offset |
|-------|------------|--|--------|--------------|---------------|
| 4     | DeltaPosY  | Difference in the position between the two receivers (m).<br>The position difference is relative to the output frame:<br>BODY = along the Y-axis<br>ECEF = along the Y-axis<br>Local level = Easting | Double | 8            | H+12          |
| 5     | DeltaPosZ  | Difference in the position between the two receivers (m).<br>The position difference is relative to the output frame:<br>BODY = along the Z-axis<br>ECEF = along the Z-axis<br>Local level = Up      | Double | 8            | H+20          |
| 6     | DeltaVelX  | Difference in velocity between the two receivers (m/s).<br>The position difference is relative to the output frame:<br>BODY = along the X-axis<br>ECEF = along the X-axis<br>Local level = Northing  | Double | 8            | H+28          |
| 7     | DeltaVelY  | Difference in velocity between two receivers (m/s).<br>The position difference is relative to the output frame:<br>BODY = along the Y-axis<br>ECEF = along the Y-axis<br>Local level = Easting       | Double | 8            | H+36          |
| 8     | DeltaVelZ  | Difference in velocity between the two receivers (m/s).<br>The position difference is relative to the output frame:<br>BODY = along the Z-axis<br>ECEF = along the Z-axis<br>Local level = Up        | Double | 8            | H+44          |
| 9     | DeltaRoll  | Difference in roll between the two receivers (degrees).  | Double | 8            | H+52          |
| 10    | DeltaPitch | Difference in pitch between the two receivers (degrees).   | Double | 8            | H+60          |



| Field | Field Type       | Description  | Format  | Binary Bytes | Binary Offset |
|-------|------------------|--|---------|--------------|---------------|
| 11    | DeltaHeading     | Difference in heading between the two receivers (degrees).   | Double  | 8            | H+68          |
| 12    | Diff Age         | Differential age in seconds.   | Float   | 4            | H+76          |
| 13    | Rover ID         | Rover receiver ID string.  | Char[4] | 4            | H+80          |
| 14    | Rover INSStatus  | INS status of the rover receiver.<br>See <i>Table 189: Inertial Solution Status</i> on page 916                          | Enum    | 4            | H+84          |
| 15    | Master ID        | Master receiver ID string.   | Char[4] | 4            | H+88          |
| 16    | Master INSStatus | INS status of the master receiver.<br>See <i>Table 189: Inertial Solution Status</i> on page 916                         | Enum    | 4            | H+92          |
| 17    | RTK Status       | Status of the current RTK vector between master and rover.<br>See <i>Table 74: Position or Velocity Type</i> on page 420 | Enum    | 4            | H+96          |
| 18    | ExtStatus        | Extended solution status. See <i>Table 190: Extended Solution Status</i> on page 922                                     | Hex     | 4            | H+100         |
| 20    | xxxx             | 32-bit CRC (ASCII and Binary only)   | Hex     | 4            | H+104         |
| 21    | [CR][LF]         | Sentence terminator (ASCII only)   | -       | -            | -             |

## 5.40 SYNCHEAVE

### *Synchronous Log Containing the Instantaneous Heave Value*

**Platform: OEM719, OEM729, OEM7500, OEM7700, OEM7720, PwrPak7, HxGN PIM7500**

Synchronous heave is available up to the rate of the IMU. It can also be logged 'on time' at lower rates.

This log also includes information about the estimated accuracy of the heave value through the standard deviation of the heave.

You must have an inertial solution to use this log. The heave filter must be enabled using the **HEAVEFILTER** command (see page 851), before this log is available.

**Message ID: 1708**

**Log Type: Synch**

**Recommended Input:**

```
log syncheavea ontime 0.05
```

**ASCII example:**

```
#SYNCHEAVEA,COM1,0,50.0,FINESTEERING,1770,245720.925,02000020,552e,12622;-0.045410579,0.436800622*b8c14286
```

| Field | Field Type       | Description  | Format | Binary Bytes | Binary Offset |
|-------|------------------|--|--------|--------------|---------------|
| 1     | SYNCHEAVE Header | Log header. See <i>Messages</i> on page 25 for more information. | -      | H            | 0             |
| 2     | Heave            | Instantaneous heave value (metres)                               | Double | 8            | H             |
| 3     | Std. Dev.        | Standard deviation of the heave value (metres)                   | Double | 8            | H+8           |
| 4     | xxxx             | 32-bit CRC (ASCII and Binary only)                               | Hex    | 4            | H+16          |
| 5     | [CR][LF]         | Sentence Terminator (ASCII only)                                 | -      | -            | -             |

## 5.41 SYNCRELINSPVA

### *Synchronous Relative INSPVA log*

**Platform: OEM719, OEM729, OEM7500, OEM7700, OEM7720, PwrPak7, HxGN PIM7500**

This log provides the relative offset between the master and rover inertial solutions. The output solution provides the offset of where the local station is with respect to the other station.



This log is designed to provide synchronous, relative Position, Velocity and Attitude information, propagating the information between matched corrections between the master and remote solutions. It is highly recommended that the highest rate of corrections be used at all times for the most precise and robust performance.

**Message ID: 1743**

**Log Type: Synch**

**Recommended Input:**

```
LOG SYNCRELINSPVAA ONTIME 1
```

**ASCII example:**

```
#SYNCRELINSPVAA,COM1,0,72.5,FINESTEERING,1805,247243.000,02000000,e9c7,13005;BODY,8.141080733,-2.779177478,2.045421773,-0.001464009,-0.001038329,0.002323548,0.409467974,0.715633909,-6.204731538,0.000000000,"B81V",INS_ALIGNMENT_COMPLETE,"B20C",INS_ALIGNMENT_COMPLETE,INS_PSRSP,00000000*e270f5c8
```

| Field | Field Type           | Description   | Format | Binary Bytes | Binary Offset |
|-------|----------------------|---|--------|--------------|---------------|
| 1     | SYNCRELINSPVA Header | Log header. See <i>Messages</i> on page 25 for more information.  | -      | H            | 0             |
| 2     | Output Frame         | The current output frame (IMU body, ECEF or local level frame).<br>The output frame is specified using the <b>SETRELINSOUTPUTFRAME</b> command (see page 885) | Enum   | 4            | H             |

| Field | Field Type | Description   | Format | Binary Bytes | Binary Offset |
|-------|------------|---|--------|--------------|---------------|
| 3     | DeltaPosX  | Difference in the position between the two receivers (m).<br>The position difference is relative to the output frame:<br>BODY = along the X-axis<br>ECEF = along the X-axis<br>Local level = Northing | Double | 8            | H+4           |
| 4     | DeltaPosY  | Difference in the position between the two receivers (m).<br>The position difference is relative to the output frame:<br>BODY = along the Y-axis<br>ECEF = along the Y-axis<br>Local level = Easting  | Double | 8            | H+12          |
| 5     | DeltaPosZ  | Difference in the position between the two receivers (m).<br>The position difference is relative to the output frame:<br>BODY = along the Z-axis<br>ECEF = along the Z-axis<br>Local level = Up       | Double | 8            | H+20          |
| 6     | DeltaVelX  | Difference in velocity between the two receivers (m/s).<br>The position difference is relative to the output frame:<br>BODY = along the X-axis<br>ECEF = along the X-axis<br>Local level = Northing   | Double | 8            | H+28          |
| 7     | DeltaVelY  | Difference in velocity between two receivers (m/s).<br>The position difference is relative to the output frame:<br>BODY = along the Y-axis<br>ECEF = along the Y-axis<br>Local level = Easting        | Double | 8            | H+36          |

| Field | Field Type       | Description   | Format  | Binary Bytes | Binary Offset |
|-------|------------------|---|---------|--------------|---------------|
| 8     | DeltaVelZ        | Difference in velocity between the two receivers (m/s).<br>The position difference is relative to the output frame:<br>BODY = along the Z-axis<br>ECEF = along the Z-axis<br>Local level = Up | Double  | 8            | H+44          |
| 9     | DeltaRoll        | Difference in roll between the two receivers (degrees).   | Double  | 8            | H+52          |
| 10    | DeltaPitch       | Difference in pitch between the two receivers (degrees).  | Double  | 8            | H+60          |
| 11    | DeltaHeading     | Difference in heading between the two receivers (degrees).  | Double  | 8            | H+68          |
| 12    | Diff Age         | Differential age in seconds.  | Float   | 4            | H+76          |
| 13    | Rover ID         | Rover receiver ID string.   | Char[4] | 4            | H+80          |
| 14    | Rover INSStatus  | INS status of the rover receiver.<br>See <i>Table 189: Inertial Solution Status</i> on page 916   | Enum    | 4            | H+84          |
| 15    | Master ID        | Master receiver ID string.  | Char[4] | 4            | H+88          |
| 16    | Master INSStatus | INS status of the master receiver.<br>See <i>Table 189: Inertial Solution Status</i> on page 916  | Enum    | 4            | H+92          |
| 17    | RTK Status       | Status of the current RTK vector between master and rover.<br>See <i>Table 74: Position or Velocity Type</i> on page 420  | Enum    | 4            | H+96          |
| 18    | ExtStatus        | Extended solution status.<br>See <i>Table 190: Extended Solution Status</i> on page 922   | Hex     | 4            | H+100         |
| 20    | xxxx             | 32-bit CRC (ASCII and Binary only)  | Hex     | 4            | H+104         |
| 21    | [CR][LF]         | Sentence terminator (ASCII only)  | -       | -            | -             |

## 5.42 TAGGEDMARK1PVA, TAGGEDMARK2PVA, TAGGEDMARK3PVA and TAGGEDMARK4PVA

### *Position, Velocity and Attitude at a Tagged Mark Request*

**Platform: OEM719, OEM729, OEM7500, OEM7700, OEM7720, PwrPak7, HxGN PIM7500**



TAGGEDMARKxPVA contains the same information as MARKxPVA with the addition of a unique identifying number (tag).



The TAGGEDMARKxPVA logs available are dependent on the receiver used in the SPAN system. For information about the Event lines supported, see the Strobe Specifications for the receiver in the [OEM7 SPAN Installation and Operation User Manual](#).

The user specifies a TAG for the upcoming TAGGEDMARKxPVA via the **TAGNEXTMARK** command (see page 890). That tag shows up at the end of this message, which is otherwise identical to the MARKXPVA message.

**Message ID:**       **1258 (TAGGEDMARK1PVA)**  
                           **1259 (TAGGEDMARK2PVA)**  
                           **1327 (TAGGEDMARK3PVA)**  
                           **1328 (TAGGEDMARK4PVA)**

**Log Type: Synch**

**Recommended Input:**

```
log taggedmark1pva onnew
log taggedmark2pva onnew
log taggedmark3pva onnew
log taggedmark4pva onnew
```

**Abbreviated ASCII Example:**

```
#TAGGEDMARK1PVAA,COM1,0,63.0,FINESTEERING,1732,247787.965,024c0020,ae1
e,12002;1732,247787.964913500,51.11693231436,-
114.03884974751,1046.9481,0.0001,0.0007,0.0004,1.090392628,0.766828598
,244.413950146,INS_SOLUTION_GOOD,1234*34fda4f4

#TAGGEDMARK2PVAA,COM1,0,73.0,FINESTEERING,1732,248347.693,020500a0,2ab
3,12002;1732,248347.692695400,51.11693017508,-
114.03884746120,1046.3929,0.0009,0.0014,0.0015,0.559580646,1.121028629
,255.541153133,INS_SOLUTION_GOOD,1234*1e97dd88

#TAGGEDMARK3PVAA,COM1,0,73.0,FINESTEERING,1732,248347.693,020500a0,2ab
3,12002;1732,248347.692695400,51.11693017508,-
```

```

114.03884746120,1046.3929,0.0009,0.0014,0.0015,0.559580646,1.121028629
,255.541153133,INS_SOLUTION_GOOD,1234*1e97dd88
#TAGGEDMARK4PVAA,COM1,0,73.0,FINESTEERING,1732,248347.693,020500a0,2ab
3,12002;1732,248347.692695400,51.11693017508,-
114.03884746120,1046.3929,0.0009,0.0014,0.0015,0.559580646,1.121028629
,255.541153133,INS_SOLUTION_GOOD,1234*1e97dd88

```

| Field | Field Type            | Description   | Format | Binary Bytes | Binary Offset |
|-------|-----------------------|---|--------|--------------|---------------|
| 1     | TAGGEDMARKxPVA Header | Log header. See <i>Messages</i> on page 25 for more information.                | -      | H            | 0             |
| 2     | Week                  | GNSS Week at Mark request   | Ulong  | 4            | H             |
| 3     | Seconds into Week     | GNSS Seconds at Mark request  | Double | 8            | H+4           |
| 4     | Latitude              | Latitude at Mark request  | Double | 8            | H+12          |
| 5     | Longitude             | Longitude at Mark request   | Double | 8            | H+20          |
| 6     | Height                | Height at Mark request  | Double | 8            | H+28          |
| 7     | North Velocity        | North Velocity at Mark request  | Double | 8            | H+36          |
| 8     | East Velocity         | East Velocity at Mark request   | Double | 8            | H+44          |
| 9     | Up Velocity           | Up Velocity at Mark request   | Double | 8            | H+52          |
| 10    | Roll                  | Roll at Mark request  | Double | 8            | H+60          |
| 11    | Pitch                 | Pitch at Mark request   | Double | 8            | H+68          |
| 12    | Azimuth               | Azimuth at Mark request   | Double | 8            | H+76          |
| 13    | Status                | INS Status at Mark request  | Enum   | 4            | H+84          |
| 14    | Tag                   | Tag ID from the <b>TAGNEXTMARK</b> command (see page 890), if any (default = 0) | Ulong  | 4            | H+88          |
| 15    | xxxx                  | 32-bit CRC (ASCII, Binary and Short Binary only)                                | Hex    | 4            | H+92          |
| 16    | [CR][LF]              | Sentence Terminator (ASCII only)  | -      | -            | -             |

## 5.43 TIMEDWHEELDATA

### *Timed Wheel Data*

**Platform: OEM719, OEM729, OEM7500, OEM7700, OEM7720, PwrPak7, HxGN PIM7500**

This log contains time stamped wheel sensor data. The time stamp in the header is the time of validity for the wheel data and not the time the TIMEDWHEELDATA log was output.

See the relevant SPAN User Manual for information about wheel sensor messages.



Depending on the method used to connect the wheel sensor (through an IMU using a UIC, an IMU in an IMU Enclosure (IMU-ISA-100C, IMU-HG1900, IMU-ENC-LN200 or IMU- $\mu$ IMU-IC), an IMU-FSAS or an IMU-CPT, or directly into an IMU-IGM enclosure), either field 3 or field 4 of the log will be filled for wheel velocity. They are equivalent, but are filled differently depending on what data is provided to SPAN.

Note that neither velocity value is used by the SPAN filter. Rather, the SPAN filter uses cumulative ticks per second.

**Message ID: 622**

**Log Type: Asynch**

**Recommended Input:**

```
log timedwheeldataa onnew
```

**ASCII Example:**

```
%TIMEDWHEELDATAA,1393,411345.001;58,0,215.814910889,0,0,1942255*3b5fa2
36
```



This example is from the iMAR iMWS wheel sensor.

| Field | Field Type            | Description   | Format | Binary Bytes | Binary Offset |
|-------|-----------------------|---|--------|--------------|---------------|
| 1     | TIMEDWHEELDATA Header | Log header. See <i>Messages</i> on page 25 for more information. (short header) | -      | H            | 0             |
| 2     | Ticks Per Rev         | Number of ticks per revolution  | Ushort | 2            | H             |
| 3     | Wheel Vel             | Wheel velocity in counts/s  | Ushort | 2            | H+2           |
| 4     | fWheel Vel            | Float wheel velocity in counts/s  | Float  | 4            | H+4           |
| 5     | Reserved              |   | Ulong  | 4            | H+8           |
| 6     |                       |   | Ulong  | 4            | H+12          |



---

| <b>Field</b> | <b>Field Type</b> | <b>Description</b>                               | <b>Format</b> | <b>Binary Bytes</b> | <b>Binary Offset</b> |
|--------------|-------------------|--|---------------|---------------------|----------------------|
| 7            | Cumulative Ticks  | Number of ticks                                  | Long          | 4                   | H+16                 |
| 8            | xxxx              | 32-bit CRC (ASCII, Binary and Short Binary only) | Hex           | 4                   | H+20                 |
| 9            | [CR][LF]          | Sentence terminator (ASCII only)                 | -             | -                   | -                    |

## 5.44 TSS1

### *TSS1 Protocol for Heave, Roll and Pitch*

**Platform: OEM719, OEM729, OEM7500, OEM7700, OEM7720, PwrPak7, HxGN PIM7500**

This log provides heave, roll and pitch information in TSS1 protocol.



This message is in a different format than any other log output by the SPAN system.



To use this log, make sure that Heave is enabled (see the **HEAVEFILTER** command (see page 851)) and the INS status is greater than INS\_ALIGNMENT\_COMPLETE

**Message ID: 1456**

**Log Type: Synch**

**Recommended Input:**

```
log tss1a ontime 1
```

**Message Format:**

```
:XXXXAAASMHHHHQMRRRRSMPPPP<CR><LF>
```

**ASCII Example:**

```
:00FFCA -0003F-0325 0319
```

| Field | Field Type              | Description  | Symbol | Example |
|-------|-------------------------|--|--------|---------|
| 1     | TSS1 Header             | Log header. See <i>Messages</i> on page 25 for more information.   | -      | 0       |
| 2     | Horizontal Acceleration | Horizontal acceleration from 0 to 9.81m/s <sup>2</sup> .<br>Shown as a one byte unsigned hex number where the least significant bit = 3.83 cm/s <sup>2</sup> . | XX     | 00      |
| 3     | Vertical Acceleration   | Vertical acceleration from -20.48 to +20.48 m/s <sup>2</sup> .<br>Shown as a two byte hex number where the least significant bit = 0.0625 cm/s <sup>2</sup> .  | AAAA   | FFCA    |
| 4     | Space Character         | A space delimiter.   | S      |         |
| 5     | Heave Polarity          | Space if positive.<br>Minus sign (-) if negative.  | M      | -       |

| Field | Field Type      | Description   | Symbol   | Example |
|-------|-----------------|---|----------|---------|
| 6     | Heave           | Heave value from -99.99 to +99.99 m.<br>Shown as a four digit integer where the least significant bit = 0.01 m.             | HHHH     | 0003    |
| 7     | Status Flag     | F if INS Active.<br>H if INS has not completed an alignment.  | Q        | F       |
| 8     | Roll Polarity   | Space if positive.<br>Minus sign (-) if negative.   | M        | -       |
| 9     | Roll            | Roll value from -99.99 to +99.99 degrees.<br>Shown as a four digit integer where the least significant bit = 0.01 degrees.  | RRRR     | 0325    |
| 10    | Space Character | A space delimiter.  | S        |         |
| 11    | Pitch Polarity  | Space if positive.<br>Minus sign (-) if negative.   | M        |         |
| 12    | Pitch           | Pitch value from -99.99 to +99.99 degrees.<br>Shown as a four digit integer where the least significant bit = 0.01 degrees. | PPPP     | 0319    |
| 13    | [CR][LF]        | Sentence terminator   | <CR><LF> |         |

## 5.45 VARIABLELEVERARM

### *Display Variable Lever Arm Details*

**Platform: OEM719, OEM729, OEM7500, OEM7700, OEM7720, PwrPak7, HxGN PIM7500**

Use this log to redisplay the re-calculated variable lever arm whenever a new **INPUTGIMBALANGLE** command is received. This message is output in the IMU body frame.

**Message ID: 1320**

**Log Type: Asynch**

**Recommended Input:**

```
log variableleverarma onnew
```

**ASCII Example:**

```
#VARIABLELEVERARMA, SPECIAL, 0, 81.5, FINESTEERING, 1614, 495820.512, 4204000  
0, 0000, 320; -0.0959421909646755, 0.1226971902356540, 1.1319295452903300,  
0.0100057787272846, 0.0122604827412661, 0.1131929545290330*9611d3c6
```

| Field | Field Type              | Description  | Format | Binary Bytes | Binary Offset |
|-------|-------------------------|--|--------|--------------|---------------|
| 1     | VARIABLELEVERARM Header | Log header. See <i>Messages</i> on page 25 for more information. | -      | H            | 0             |
| 2     | XOffset                 | IMU body frame x-axis offset                                     | Double | 8            | H             |
| 3     | YOffset                 | IMU body frame y-axis offset                                     | Double | 8            | H+8           |
| 4     | ZOffset                 | IMU body frame z-axis offset                                     | Double | 8            | H+16          |
| 5     | XUncert                 | X-axis uncertainty in metres                                     | Double | 8            | H+24          |
| 6     | YUncert                 | Y-axis uncertainty in metres                                     | Double | 8            | H+32          |
| 7     | ZUncert                 | Z-axis uncertainty in metres                                     | Double | 8            | H+40          |
| 8     | xxxx                    | 32-bit CRC (ASCII, Binary and Short Binary only)                 | Hex    | 4            | H+48          |
| 9     | [CR][LF]                | Sentence terminator (ASCII only)                                 | -      | -            | -             |

## 5.46 WHEELSIZE

### *Wheel Size*

**Platform: OEM719, OEM729, OEM7500, OEM7700, OEM7720, PwrPak7, HxGN PIM7500**

This log contains wheel sensor information.

The inertial filter models the size of the wheel to compensate for changes in wheel circumference due to hardware or environmental changes. The default wheel size is 1.96 m. A scale factor to this default size is modeled in the filter and this log contains the current estimate of the wheel size.

**Message ID: 646**

**Log Type: Asynch**

**Recommended Input:**

```
log wheelsizea onnew
```

**ASCII Example:**

```
#WHEELSIZEA,COM3,0,44.0,FINESTEERING,0,0.000,02000000,85f8,33738;1.025  
108123,2.009211922,0.000453791*b65d28e6
```

| Field | Field Type       | Description  | Format | Binary Bytes | Binary Offset |
|-------|------------------|--|--------|--------------|---------------|
| 1     | WHEELSIZE Header | Log header. See <i>Messages</i> on page 25 for more information. | -      | H            | 0             |
| 2     | Scale            | Wheel sensor scale factor  | Double | 8            | H             |
| 3     | Circum           | Wheel circumference (m)  | Double | 8            | H+8           |
| 4     | Var              | Variance of circumference (m <sup>2</sup> )                      | Double | 8            | H+16          |
| 5     | xxxx             | 32-bit CRC (ASCII, Binary and Short Binary only)                 | Hex    | 4            | H+24          |
| 6     | [CR][LF]         | Sentence terminator (ASCII only)                                 | -      | -            | -             |

## Chapter 6 Responses

The receiver is capable of outputting several responses for various conditions. Most responses are error messages to indicate when something is not correct.

The output format of the messages is dependent on the format of the input command. If the command is input as abbreviated ASCII, the output will be abbreviated ASCII. The same rule applies for both ASCII and binary formats.

**Table 210: Response Messages**

| ASCII Message                         | Binary Message ID | Meaning   |
|---------------------------------------|-------------------|---|
| OK                                    | 1                 | Command was received correctly  |
| Requested log does not exist          | 2                 | The log requested does not exist  |
| Not enough resources in system        | 3                 | The request has exceeded a limit (for example, the maximum number of logs are being generated)      |
| Data packet doesn't verify            | 4                 | Data packet is not verified   |
| Command failed on receiver            | 5                 | Command did not succeed in accomplishing requested task   |
| Invalid Message ID                    | 6                 | The input message ID is not valid   |
| Invalid Message. Field = x            | 7                 | Field x of the input message is not correct   |
| Invalid Checksum                      | 8                 | The checksum of the input message is not correct. Only applies to ASCII and binary format messages. |
| Message missing field                 | 9                 | A field is missing from the input message   |
| Array size for field x exceeds max    | 10                | Field x contains more array elements than allowed   |
| parameter x is out of range           | 11                | Field x of the input message is outside the acceptable limits                                       |
| Message Id already exists in system   | 12                | Message Id already exists in system   |
| Debug token unknown                   | 13                | Debug token unknown   |
| Trigger x not valid for this log      | 14                | Trigger type x is not valid for this type of log  |
| Authcode table full - Reload Software | 15                | Too many authcodes are stored in the receiver. The receiver firmware must be reloaded               |

| <b>ASCII Message</b>               | <b>Binary Message ID</b> | <b>Meaning</b>  |
|------------------------------------|--------------------------|---|
| Invalid date format                | 16                       | This error is related to the inputting of authcodes. Indicates the date attached to the code is not valid |
| Invalid Authcode entered           | 17                       | The authcode entered is not valid   |
| No matching model to remove        | 18                       | The model requested for removal does not exist  |
| Not valid Auth code for that Model | 19                       | The model attached to the authcode is not valid   |
| Channel is invalid                 | 20                       | The selected channel is invalid   |
| Requested rate is invalid          | 21                       | The requested rate is invalid   |
| Word has no mask for this type     | 22                       | The word has no mask for this type of log   |
| Channels locked due to error       | 23                       | Channels are locked due to error  |
| Injected time invalid              | 24                       | Injected time is invalid  |
| Com port not supported             | 25                       | The COM or USB port is not supported  |
| Message is incorrect               | 26                       | The message is invalid  |
| Invalid PRN                        | 27                       | The PRN is invalid  |
| PRN not locked out                 | 28                       | The PRN is not locked out   |
| PRN lockout list is full           | 29                       | PRN lockout list is full  |
| PRN already locked out             | 30                       | The PRN is already locked out   |
| Message timed out                  | 31                       | Message timed out   |
| Unknown COM port requested         | 33                       | Unknown COM or USB port requested   |
| Hex string not formatted correctly | 34                       | Hex string not formatted correctly  |
| Invalid baud rate                  | 35                       | The baud rate is invalid  |
| Message is invalid for this model  | 36                       | Message is invalid for this model of receiver   |

| <b>ASCII Message</b>                    | <b>Binary Message ID</b> | <b>Meaning</b>                                   |
|---|--------------------------|--|
| Could Not Save Configuration            | 38                       | Could Not Save Configuration                     |
| Too Many Configuration Items            | 39                       | Too Many Configuration Items                     |
| Command only valid if in NVM Fail mode  | 40                       | Command is only valid if NVM is in fail mode     |
| Invalid offset                          | 41                       | The offset is invalid                            |
| File conflict                           | 43                       | File conflict                                    |
| File not found                          | 44                       | File not found                                   |
| File open                               | 45                       | File open  |
| File not open                           | 46                       | File not open                                    |
| Invalid DOS FileName                    | 47                       | Invalid DOS File name                            |
| File channel in use                     | 48                       | File channel in use                              |
| File close fail                         | 50                       | File close fail                                  |
| Disk not present                        | 51                       | Disk not present                                 |
| Disk error                              | 52                       | Disk error                                       |
| Disk full                               | 53                       | Disk full  |
| NVM Write Fail                          | 74                       | NVM Write Fail                                   |
| NVM Read Fail                           | 75                       | NVM Read Fail                                    |
| Not allowed for input                   | 77                       | Not allowed for input                            |
| Maximum number of user messages reached | 78                       | Maximum number of user messages has been reached |
| User message decryption failed          | 79                       | User message decryption failed                   |
| GPS precise time is already known       | 84                       | GPS precise time is already known                |
| The message could not be created        | 87                       | The message could not be created                 |
| Not enough memory to start application  | 113                      | Not enough memory to start application           |



| ASCII Message                            | Binary Message ID | Meaning  |
|--|-------------------|--|
| No data available                        | 114               | No data available  |
| Invalid handshaking                      | 117               | Invalid handshaking  |
| Message name already exists              | 118               | Message name already exists  |
| Invalid message name                     | 119               | Invalid message name   |
| The datatype is invalid                  | 120               | The data type is invalid   |
| Message ID is reserved                   | 121               | Message ID is reserved   |
| Message size too large                   | 122               | Message size too large   |
| Invalid Security Key                     | 126               | Invalid security key   |
| Hardware not available                   | 127               | Hardware not available   |
| Requested pulse width is invalid         | 131               | Requested pulse width is invalid   |
| Coarse time is not achieved yet          | 133               | Coarse time is not achieved yet  |
| Invalid Config Code                      | 134               | Invalid Config Code  |
| ConfigCode table full - Reload Software  | 135               | Config Code table is full. Reload the software.  |
| Unknown Object Type                      | 136               | Unknown object type  |
| This operation is not valid at this time | 137               | This operation is not valid at this time   |
| User VARF in use                         | 140               | User VARF in use   |
| Must enable CLOCKADJUST                  | 141               | Must enable CLOCKADJUST. See the <b>CLOCKADJUST</b> command on page 101 for information about enabling.                          |
| Disk busy                                | 142               | Disk busy  |
| Invalid Word Input Argument              | 143               | Invalid Word Input Argument  |
| Parameter %d is not valid for this model | 148               | The parameter specified is not valid for this model  |
| ZUPT DISABLED BY USER                    | 149               | An <b>INSZUPT</b> command (see page 864) was sent after a <b>SETINSUPDATE ZUPT</b> command was used to disable the use of ZUPTs. |

| ASCII Message                                | Binary Message ID | Meaning  |
|--|-------------------|--|
| IMU SPECS LOCKED FOR THIS IMU TYPE           | 150               | SPAN allows the default specifications for a select few IMUs to be modified to support different variants. However, most IMU specifications are not allowed to change. |
| Invalid interface mode. Parameter %d         | 151               | The specified Interface mode parameter is not valid.   |
| COMMAND INVALID FOR THIS IMU                 | 154               | The entered command cannot be used with the configured IMU. For example, the <b>INSCALIBRATE ANT1</b> command is not valid for lower quality IMUs.                     |
| IMU protocol is locked for this IMU type     | 155               | IMU protocol is locked for this IMU type   |
| IMU TYPE IS NOT SUPPORTED WITH CURRENT MODEL | 157               | A firmware model upgrade is required to use the requested IMU ( <b>CONNECTIMU</b> command on page 845).  |
| Trigger start time is invalid                | 159               | Trigger start time is invalid  |
| Sensor is not initialized                    | 160               | Sensor is not initialized  |
| TRIGGER BUFFER IS FULL                       | 161               | The <b>TIMEDEVENTPULSE</b> command (see page 891) limit of 10 events has been reached, and a new event cannot be set until an event is cleared.                        |
| Board has not achieved finesteering          | 162               | The receiver has not achieved finesteering   |
| SETUPSENSOR COMMAND IS LOCKED                | 163               | The <b>SETUPSENSOR</b> command (see page 887) command cannot be modified because there are remaining trigger events queued.  |
| Invalid Profile Name                         | 165               | Invalid Profile Name   |
| Maximum Number Profiles Exceeded             | 166               | The maximum number of profiles is exceeded   |
| Failed To Delete Profile                     | 167               | Failed to delete the profile   |
| Profile Name Already Exists                  | 168               | Profile name already exists  |

| ASCII Message  | Binary Message ID | Meaning  |
|--|-------------------|--|
| Total Profile Commands Size Over Limit                             | 169               | Total Profile commands size over limit                             |
| Cannot Change Profile When Activated                               | 170               | Cannot change a Profile when it is activated                       |
| Signature Authcode Copy Fail                                       | 171               | Signature Authcode copy fail                                       |
| Maximum Number of Profile Commands Exceeded                        | 172               | The maximum number of <b>PROFILE</b> commands exceeded             |
| Profile Active, Could Not Save Configuration                       | 173               | Profile active, could not save configuration                       |
| Current PPP position has bad status and cannot be used for seeding | 178               | Current PPP position has bad status and cannot be used for seeding |
| PPP seed position failed integrity check                           | 179               | PPP seed position failed integrity check                           |
| Invalid password   | 180               | Invalid password   |
| Too many files   | 181               | Too many files   |
| Encryption key output is not allowed                               | 186               | Encryption key output is not allowed                               |
| Secure port requires login   | 187               | Secure port requires login   |
| NMEA2000/J1939 stack is already running on the CAN port            | 188               | NMEA2000/J1939 stack is already running on the CAN port            |
| No saved PPP seed position   | 191               | No saved PPP seed position   |
| System type is invalid for this model                              | 192               | System type is invalid for this model                              |
| Command is not supported for this model                            | 193               | Command is not supported for this model                            |
| Position Averaging Not Started                                     | 194               | Position averaging not started                                     |

| ASCII Message  | Binary Message ID | Meaning  |
|--|-------------------|--|
| Not in GLIDE mode                                      | 200               | Not in GLIDE mode  |
| PPP seeding invalid in forced dynamics mode            | 201               | PPP seeding invalid in forced dynamics mode  |
| Wrong combination of parameters                        | 202               | Wrong combination of parameters  |
| Invalid Calibration Request                            | 203               | Invalid calibration request  |
| Active Gimbal Detected                                 | 204               | Active gimbal detected   |
| Authcode table full - Use auth erase_table             | 205               | Authcode table full. An authcode must be removed before another authcode can be added.<br>Refer to the <b>AUTH</b> command (see page 74) for instructions on removing authcodes and cleaning up the authcode table.. |
| Profile Not Running - Profile should be activated      | 206               | Profile not running - Profile should be activated  |
| ID provided is already in use                          | 208               | ID provided is already in use  |
| ID provided does not exist                             | 209               | ID provided does not exist   |
| Calibration already in progress                        | 210               | Calibration already in progress  |
| Filter cannot be enabled due to channel speed settings | 211               | Filter cannot be enabled due to channel speed settings   |
| Notch Filter and Frequency are mismatching             | 212               | Notch filter and frequency are mismatching   |
| Filter can not cascade                                 | 213               | Filter can not cascade   |
| There is no RF filter applied                          | 214               | There is no RF filter applied  |
| ID provided should be 4 character long                 | 215               | ID provided should be 4 characters long  |

| <b>ASCII Message</b>                               | <b>Binary Message ID</b> | <b>Meaning</b>  |
|--|--------------------------|---|
| Invalid subscription code                          | 216                      | Invalid subscription code                               |
| Subscription table full                            | 217                      | Subscription table full                                 |
| Network id does not match subscription code        | 218                      | Network ID does not match the subscription code         |
| Subscription not found                             | 219                      | Subscription not found                                  |
| Subscription not active                            | 220                      | Subscription not active                                 |
| Cannot activate expired subscription               | 221                      | Cannot activate expired subscription                    |
| Maximum number of logs exceeded. No new log added. | 222                      | Maximum number of logs exceeded. No new log added.      |
| Seed is too far in the past                        | 223                      | Seed is too far in the past                             |
| Final log request must use the ONCE trigger        | 224                      | Final log request must use the ONCE trigger             |
| Estimated RBV must be entered first                | 227                      | Initial RBV estimate is required before RBV calibration |

# APPENDIX A Example of Bit Parsing a RANGECMP4 Log

The following takes a sample RANGECMP4 log and breaks it down into its raw components.

Data was captured in both RANGE and in RANGECMP4 logs which are shown here for reference. These logs were captured at a rate of 4 Hz such that the Reference and Differential parts of the RANGECMP4 could be explained.



Some of the RANGECMP4 values will have some very slight differences (at the millicycle level) compared to the equivalent RANGE log data due to truncating the double values into integers.

Here are two RANGE logs to reference against once the RANGECMP4 logs have been determined:

```
RANGE COM1 0 88.5 FINESTEERING 1919 507977.000 02000020 5103 32768
22
    27 0 21761200.335 0.036 -114355879.993103 0.006 1121.758 50.0
876.785 18109c04
    27 0 21761202.795 0.128 -89108485.029683 0.007 874.097 44.2
862.386 11303c0b
    27 0 21761200.306 0.007 -85395622.838987 0.004 837.685 51.7
865.845 01d03c04
    21 0 21214757.684 0.027 -111484302.588995 0.005 -1107.624 52.6
888.968 08109c24
    21 0 21214757.049 0.122 -86870882.607297 0.006 -863.084 44.6
874.389 01303c2b
    10 0 21540290.811 0.027 -113194996.162910 0.005 2288.688 52.6
889.905 08109c44
    10 0 21540293.632 0.110 -88203904.731314 0.006 1783.394 45.6
868.725 01303c4b
    10 0 21540289.869 0.006 -84528728.138216 0.004 1709.022 53.0
872.386 01d03c44
    15 0 21776375.653 0.032 -114435625.391762 0.007 -1814.485 50.9
879.586 18109c64
    15 0 21776376.038 0.129 -89170616.457446 0.007 -1413.886 44.1
862.706 11303c6b
    18 0 20493192.703 0.031 -107692454.149639 0.007 212.747 51.1
891.550 08109c84
    18 0 20493191.933 0.105 -83916195.494946 0.007 165.777 45.9
874.710 01303c8b
    61 9 20375330.794 0.104 -108956045.737322 0.006 -3039.481 46.8
891.931 08119ca4
    61 9 20375332.806 0.083 -84743599.055547 0.007 -2364.042 34.0
876.813 00b13cab
    55 4 22748433.080 0.146 -121432681.638722 0.009 4061.119 43.9
416.032 18119cc4
    55 4 22748438.602 0.021 -94447660.068923 0.009 3158.651 46.0
415.562 00b13ccb
```

```
38 8 19781617.845 0.058 -105744080.698106 0.004 -2024.611 51.8
893.563 18119ce4
38 8 19781623.453 0.032 -82245418.313339 0.005 -1574.698 42.2
878.833 00b13ceb
39 3 19968976.955 0.055 -106558290.405759 0.004 2248.713 52.3
875.210 08119d04
39 3 19968980.676 0.019 -82878686.553631 0.005 1749.000 46.9
870.890 00b13d0b
54 11 19507573.213 0.059 -104388964.028915 0.005 1289.410 51.8
894.613 08119d24
54 11 19507576.477 0.017 -81191427.275619 0.004 1002.874 48.0
878.832 10b13d2b

RANGE COM1 0 88.5 FINESTEERING 1919 507977.250 02000020 5103 32768
22
27 0 21761146.982 0.036 -114355599.642256 0.006 1121.140 49.9
877.035 18109c04
27 0 21761149.447 0.122 -89108266.573995 0.007 873.616 44.6
862.636 11303c0b
27 0 21761146.957 0.007 -85395413.484293 0.004 837.294 51.8
866.095 01d03c04
21 0 21214810.390 0.027 -111484579.560955 0.005 -1108.100 52.6
889.218 08109c24
21 0 21214809.754 0.120 -86871098.429369 0.005 -863.454 44.8
874.639 01303c2b
10 0 21540181.949 0.027 -113194424.080322 0.005 2288.176 52.6
890.155 08109c44
10 0 21540184.767 0.111 -88203458.952394 0.006 1782.995 45.4
868.975 01303c4b
10 0 21540181.003 0.006 -84528300.928648 0.004 1708.751 53.0
872.636 01d03c44
15 0 21776461.990 0.032 -114436079.084785 0.006 -1814.956 50.9
879.836 18109c64
15 0 21776462.375 0.129 -89170969.984233 0.007 -1414.253 44.1
862.956 11303c6b
18 0 20493182.598 0.031 -107692401.054068 0.007 212.183 51.2
891.800 08109c84
18 0 20493181.833 0.110 -83916154.122137 0.007 165.338 45.6
874.960 01303c8b
61 9 20375472.914 0.104 -108956805.696703 0.006 -3040.142 46.9
892.181 08119ca4
61 9 20375474.924 0.084 -84744190.134355 0.007 -2364.555 33.9
877.063 00b13cab
55 4 22748242.897 0.150 -121431666.427728 0.009 4060.804 43.7
416.282 18119cc4
55 4 22748248.421 0.021 -94446870.460803 0.009 3158.405 46.0
415.812 00b13ccb
38 8 19781712.549 0.059 -105744586.938646 0.004 -2025.149 51.8
893.813 18119ce4
38 8 19781718.158 0.032 -82245812.055601 0.005 -1575.117 42.3
879.083 00b13ceb
```

```

39 3 19968871.615 0.055 -106557728.318448 0.004 2248.162 52.3
875.460 08119d04
39 3 19968875.343 0.019 -82878249.374953 0.005 1748.571 46.8
871.140 00b13d0b
54 11 19507512.994 0.059 -104388641.780659 0.005 1288.778 51.7
894.863 08119d24
54 11 19507516.256 0.016 -81191176.637999 0.005 1002.383 48.1
879.082 10b13d2b

```

Here are the equivalent RANGEEMP4 logs which will be broken down into their individual components:

```

#RANGEEMP4A,COM1,0,88.5,FINESTEERING,1919,507977.000,02000020,fb0e,
32768;295,03000042120400000009200df7688831f611fd87ca0b03a00638bbdf7b8
2f49b080fd0ec0ff1f091f8214ff4d4d00a1009cbf1751f6911f5141f87fd9571a96db
d7040c8090f87f0080fcf722fe9bfa8a49a8ff4f299d7f96fb9afefc771800fcffd006
3f02cde01f3c7dd3ffb75240886f5fa2b0ff91f57f00003edf8b78868c882878014065
dbf7d3ed6b722680d5fc0f00a4c08730fe7fecf8bffa3f003008000000002001f03fa0
19f8136a11273649b8fcefab9c434c7b89e71560dbfe070030b2e04fd841f33125320b
80b0ecef5ee21243ac0bb03e0ffc36a813fb13bbe5791a0f5ff9e3bdbffbb87f0cb80
64f03f0000e4b67dd15bc5f4a50a3a006ca72fdee53ec86405b2c0fffa3fa450f725d5
bfed7c49b1fb0fb16b45a87a9adb0740cbfe0700*7DD8F893

```

```

#RANGEEMP4A,COM1,0,88.5,FINESTEERING,1919,507977.250,02000020,fb0e,
32768;239,03000042120400000009200dff688831f6102005500e70162dc977c0040
15c07988840f6101803a805921cedf8b80002011207080e5f6351f003804081c2200be
0808005c01620808725f93028057801822dae0476000a00f207180fef6251700e80340
1c62f3bdc8060052013009986f5f22020054004ca2053ec408005401ca870180410000
000000980ff6306fec408004801de07c8692f5102805180f721b2e04f600040152081
804ef7102500600540202205fe040a0086013a0938780f61020061804e224edbdb6800
2010c0498030f7411d0018047812a2d47d090a004c01a609c8544f62028052006a02
*48E189A2

```

## A.1 Reference Log Decoding

The RANGEEMP4 log at time 507977.0 will be decoded first:

```

#RANGEEMP4A,COM1,0,88.5,FINESTEERING,1919,507977.000,02000020,fb0e,
32768;295,03000042120400000009200df7688831f611fd87ca0b03a00638bbdf7b8
2f49b080fd0ec0ff1f091f8214ff4d4d00a1009cbf1751f6911f5141f87fd9571a96db
d7040c8090f87f0080fcf722fe9bfa8a49a8ff4f299d7f96fb9afefc771800fcffd006
3f02cde01f3c7dd3ffb75240886f5fa2b0ff91f57f00003edf8b78868c882878014065
dbf7d3ed6b722680d5fc0f00a4c08730fe7fecf8bffa3f003008000000002001f03fa0
19f8136a11273649b8fcefab9c434c7b89e71560dbfe070030b2e04fd841f33125320b
80b0ecef5ee21243ac0bb03e0ffc36a813fb13bbe5791a0f5ff9e3bdbffbb87f0cb80
64f03f0000e4b67dd15bc5f4a50a3a006ca72fdee53ec86405b2c0fffa3fa450f725d5
bfed7c49b1fb0fb16b45a87a9adb0740cbfe0700*7DD8F893

```

Since this log falls on a whole second (507977.000), it is a Reference log.

At the start of the RANGEEMP4 log is the identifier for how many bytes are in the log. In this case, there are 295 bytes. The rest of the message is compressed binary data and is transmitted as LSB first so the bytes must be swapped before processing.



### A.1.1 Reference Header

The Reference Header is sent once per message. See *Table 135: Header* on page 681 in the RANGEEMP4 log section.

Decoding the bits starting with the first bytes:

*GNSS Field* (16 bits)

- Grab the first 2 bytes (16 bits) = 0x0300
- Swap the bytes = 0x0003
- 0x0003 in binary form = 0000 0000 0000 0011

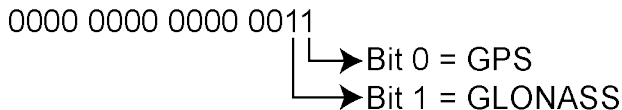

In this example the receiver was configured to track only GPS and GLONASS systems. If other systems had been in the configuration and tracked, they would have shown here.

### A.1.2 Reference Satellite and Signal Block: GPS

This block is sent once for each bit set to 1 in the GNSS field (See *Table 135: Header* on page 681). As identified by the above GNSS field, the first system (right to left) is the GPS System. Use *Table 136: Satellite and Signal Block* on page 682 to determine what satellites and signals data are contained in this GPS system:

*GPS Satellites field* (64 bits)

- Grab the next 8 bytes (64 bits) = 0x0042120400000000
- Swap the bytes = 0x0000000004124200
- 0x0000000004124200 in binary form =

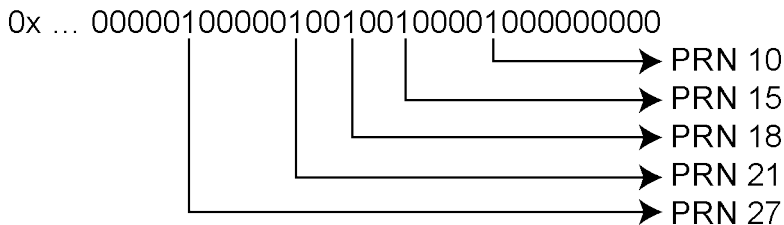

- The 1's above identify that there are 5 tracking GPS PRNs.

*GPS Signals field* (16 bits)

- Grab the next 2 bytes (16 bits) = 0x9200
- Swap the bytes = 0x0092
- 0x0092 in binary form =

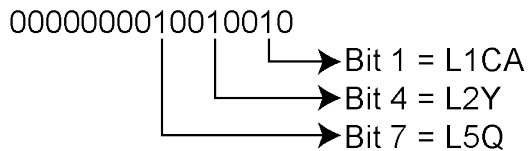

- The 1's above identify that there are 3 tracking GPS signals: L1CA, L2Y, and L5Q.

*GPS Included Signals field* (5 PRNs x 3 Signals = 15 bits – Therefore need 2 bytes)

- Up to the point of processing the Included Signals field, the bytes are aligned such that the bits start and end within each batch of bytes. After processing this step, it is quite common for the Included Signals Field (mxn matrix) to not be divisible by 8 so bytes not processed will need to be carried over to the next section depending on the size of the matrix.
- Grab the next 2 bytes (16 bits) = 0xdf76
- Swap the bytes = 0x76df
- 0x76df in binary form = 0111011011011111
- Only need 15 of the 16 bits = X111011011011111
- This bit string breaks down into 5 rows (PRNs) and 3 columns (signals) as specified by the mxn (PRN x signals) parameters. Take the bit string and break it up into sets of 3 starting at the MSB. This will result with the lowest PRN being at the bottom row of the stack and the first signal (L1CA) being the far right column.

```

111
011
011
011
111
    
```

- This stack can be further broken apart to identify the PRNs vs. their Signals:

| PRN | L5Q | L2Y | L1CA |
|-----|-----|-----|------|
| 27  | 1   | 1   | 1    |
| 21  | 0   | 1   | 1    |
| 18  | 0   | 1   | 1    |
| 15  | 0   | 1   | 1    |
| 10  | 1   | 1   | 1    |

### A.1.3 Reference Measurement Block Header: GPS

This block is sent once for each bit set to 1 in the Satellites field found in *Table 136: Satellite and Signal Block* on page 682. Now that the PRN's signals have been determined, the next step is to determine the specifics of the first PRN (10) and its list of signals (L1CA, L2Y, L5Q). Working from bottom right to upper left of the PRN/Signal chart above, each 1 represents a signal for a PRN. Use *Table 137: Measurement Block Header* on page 683 to determine the contents of each field:

*GPS PRN 10* (first PRN found in the Satellites field)

We will grab enough bytes to process the whole Measurement Block Header. If this was a GLONASS System, a total of 9 bits would be required for this step (1 bit for the Data Format Flag, 3 bits for the Ref Data Block ID, plus 5 bits for the GLONASS Frequency Number). Since this is a GPS system, only 4 bits in total are required (1 bit for the Data Format Flag and 3 bits for the Ref Data Block ID).

There was 1 bit not processed in the last byte so that byte will be carried forward. Only 4 bits need to be looked at for this step so grab the next byte as well:

- Use the last byte (0x76) plus the next byte (0x88)= 0x7688
- Swap the bytes = 0x8876
- 0x8876 in binary form = 1000100001110110
- Ignore the 7 processed bits from the last step = 100010000XXXXXXX
- Ignore the 5 MSB bits leaving 4 bits for processing =

XXXXXX0000XXXXXXXX

0 = Data Format Flag (1 bit)

000 = Ref Data Block (3 bits)

The Data Format Flag identifies that this batch of data is Reference (0) data.  
The Ref Data Block ID is 0x000.



The 5 MSB's have not been processed so this byte will be carried forward.

The Data Format Flag identifies if the upcoming data is Reference or Differential data. By default every log that was published on a whole second will always be Reference logs. Logs between seconds will be Differential logs but could be Reference logs depending on the compression calculations. If a discontinuity occurred that made it impossible for a Differential calculation to fit within the Differential Constraints, it will revert to a Reference log.

#### **A.1.4 Reference Measurement Block: GPS**

This block is sent once for each bit set to 1 in the Included Signals Field found in *Table 136: Satellite and Signal Block* on page 682. Use *Table 138: Primary Reference Signal Measurement Block* on page 684 and *Table 139: Secondary Reference Signals Measurement Block* on page 685 to determine the contents of each field:

A Measurement Block for a single PRN will look like the following:

Primary Parity Flag

Primary 1/2 Cycle Slip Flag

Primary C/No

Primary Lock Time

Primary Pseudorange Std Deviation

Primary Phaserange Std Deviation

Primary Pseudorange

Primary Phaserange - Primary Pseudorange (determines the Phaserange for the 1<sup>st</sup> Signal)

Primary Doppler

2<sup>nd</sup> Parity Flag

2<sup>nd</sup> 1/2 Cycle Slip Flag

2<sup>nd</sup> C/No

2<sup>nd</sup> Lock Time  
2<sup>nd</sup> Pseudorange Std Deviation  
2<sup>nd</sup> Phaserange Std Deviation  
2<sup>nd</sup> Pseudorange - Primary Pseudorange (determines the Pseudorange for the 2<sup>nd</sup> Signal)  
2<sup>nd</sup> Phaserange - 2<sup>nd</sup> Pseudorange (determines the Phaserange for the 2<sup>nd</sup> Signal)  
2<sup>nd</sup> Doppler - Primary Doppler (determines the Doppler for the 2<sup>nd</sup> Signal)

3<sup>rd</sup> Parity Flag  
3<sup>rd</sup> ½ Cycle Slip Flag  
3<sup>rd</sup> C/No  
3<sup>rd</sup> Lock Time  
3<sup>rd</sup> Pseudorange Std Deviation  
3<sup>rd</sup> Phaserange Std Deviation  
3<sup>rd</sup> Pseudorange - Primary Pseudorange (determines the Pseudorange for the 3<sup>rd</sup> Signal)  
3<sup>rd</sup> Phaserange - 3<sup>rd</sup> Pseudorange (determines the Phaserange for the 3<sup>rd</sup> Signal)  
3<sup>rd</sup> Doppler - Primary Doppler (determines the Doppler for the 3<sup>rd</sup> Signal)

...

### **A.1.5 Reference Primary Signal Measurement Block: GPS PRN 10 – L1CA**

The next bytes collected will be for the GPS PRN 10 - L1CA signal data. This is the primary signal of the PRN since it is the first signal. As a result, its Measurement Block consists of 111 bits as listed in *Table 138: Primary Reference Signal Measurement Block* on page 684. Since 111 bits takes up a lot of space, these bits will be split into two groups from *Table 138: Primary Reference Signal Measurement Block* on page 684: the top 25 bits for signal info followed by the bottom 86 bits for signal data.

The signal info section (top 25 bits) is processed as follows:

- With 5 bits left unprocessed from the previous byte, we calculate  $25 - 5 = 20$  bits which rounds up to 3 bytes. Therefore the previous last byte (0x88) plus the next 3 bytes will be needed.
  - Use the last byte (0x88) plus grab 3 bytes (x831f61) = 0x88831f61
  - Swap the bytes = 0x611f8388
  - 0x611f8388 in binary form = 01100001000111111000001110001000
  - The previous step used the 3 LSB's = 01100001000111111000001110001XXX

- 25 bits are needed so ignore the 4 MSB's =

XXXX0001000111111000001110001XXX

|             |   |                             |
|-------------|---|-----------------------------|
|             | 1 | = Parity Flag               |
|             | 0 | = ½ Cycle Slip Flag         |
| 10000011100 |   | = C/No                      |
| 1111        |   | = Lock Time                 |
| 0001        |   | = Pseudorange Std Deviation |
| 0001        |   | = Phaserange Std Deviation  |

- Parity flag is a 1 (Parity Known)
- ½ Cycle Slip flag is a 0 (Cycle Slip Not Present)
- C/No is:  
0x10000011100b = 1052 x Scaling Factor of 0.05  
= 52.60 dBHz
- The Lock Time value is:  
0x1111b = 15 which means that this signal has been locked for 262144 ms or more.
- The Pseudorange Std Deviation value is:  
0x0001b = 1 which means: 0.020 m < PSR Std Dev <= 0.030 m using *Table 145: Pseudorange Std Dev* on page 691.
- The ADR Std Deviation value is:  
0x0001b = 1 which means: 0.0039 < ADR Std Dev <= 0.0052 cycles using *Table 144: ADR Std Dev* on page 690.

The signal data section (bottom 86 bits) is processed as follows:

- With 4 bits unprocessed from the previous byte, we calculate 86 – 4 = 82 bits = 11 bytes (2 bits will not be processed in the last byte).
  - Use the last byte (0x61) plus grab 11 bytes (0x1fd87ca0b03a00638bbdf7)  
= 0x611fd87ca0b03a00638bbdf7
  - Swap the bytes = 0xf7bd8b63003ab0a07cd81f61
  - 0xf7bd8b63003ab0a07cd81f61 in binary form =  
111 0111 1011 1101 1000 1011 0110 0011 0000 0000 0011 1010 1011 0000 1010 0000  
0111 1100 1101 1000 0001 1111 0110 0001
  - Only need 86 bits. Ignore last 4 LSB's and first 6 MSB's =

|   |  |
|---|--|
| XXXX XX11 1011 1101 1000 1011 0110 0011 0000 0000 0011 1010 1011 0000 1010 0000 0111 1100 1101 1000 0001 1111 0110 XXXX | = 1 <sup>st</sup> Pseudo                         |
| 0000 0000 0011 1010 1011 000  | = 1 <sup>st</sup> Phase - 1 <sup>st</sup> Pseudo |
| 11 1011 1101 1000 1011 0110 0011  | = 1 <sup>st</sup> Doppler                        |

- Use *Table 138: Primary Reference Signal Measurement Block* on page 684 to identify if a 2's Complement Conversion is needed as well as what Scale Factor should be used before these binary numbers are used in the following calculations.
- The 1st (Primary) Pseudorange is processed by:  
1st Pseudorange = 0x0101000000111110011011000000111110110b x Scaling Factor  
1st Pseudorange = 43080581622 x 0.0005  
L1CA Pseudorange for PRN 10= 21540290.811 m
- The 1st (Primary) Phaserange is a 2's Complement number (as identified by the Range

column in *Table 138: Primary Reference Signal Measurement Block* on page 684) so it is processed in the following manner:

1st Phaserange – 1st Pseudorange = 2's Complement(0x00000000001110101011000b) \*  
Scaling Factor

1st Phaserange – 21540290.811 m = 7512 \* 0.0001

L1CA Phaserange = 21540291.5622 m

- Convert this to ADR to check against the original RANGE log:

ADR = 1st Phaserange \* Frequency \* (-1)/Speed Of Light

ADR = 21540291.5622 m \* 1575420000 Hz \* (-1)/299792458 m/s

L1CA ADR for PRN 10 = -113194996.1627158 cycles



In the range logs, PSR and ADR have opposite signs.

- The 1st (Primary) Doppler is a 2's Complement number (as identified by the Range column in *Table 138: Primary Reference Signal Measurement Block* on page 684) so it is processed in the following manner:

1st Doppler(m/s) = 2's Complement(0x11101111011000101101100011b) x Scaling Factor

1st Doppler(m/s) = -4,355,229 x 0.0001

L1CA Doppler(m/s) = -435.5229 m/s

Convert the Doppler to Hz:

1st Doppler(Hz) = 1st Doppler(m/s) x Frequency \* (-1)/Speed Of Light

L1CA Doppler(Hz) for PRN 10 = 2288.6883 Hz

1st Doppler(Hz) = -435.5229 m/s x 1575420000 Hz \* (-1)/299792458 m/s

### **A.1.6 Reference Secondary Signals Measurement Block: GPS PRN 10 – L2Y**

Signal L1CA was the 1st signal (Primary Signal) of the three PRN 10 signals found in this RANGECMP4 log data. L1CA's data is now used to determine the L2Y's signals data. Since this is the second signal block of this PRN, its data will be processed by using *Table 139: Secondary Reference Signals Measurement Block* on page 685.

With 6 bits left unprocessed from the previous byte, we will require  $82 - 6 = 76$  bits which rounds up to 10 bytes.

- Use the last byte (0xf7) plus grab the next 10 bytes (0xb82f49b080fd0ec0ff1f)  
= 0xf7b82f49b080fd0ec0ff1f
- Swap the bytes = 0x1fffc00efd80b0492fb8f7
- 0x1fffc00efd80b0492fb8f7 in binary form =  
0001 1111 1111 1111 1100 0000 0000 1110 1111 1101 1000 0000 1011 0000 0100 1001 0010  
1111 1011 1000 1111 0111
- Only need 78 bits. The 2 LSB's are ignored as they were already processed above and the 4

MSB's are ignored so there is a total of 82 bits to process

```

xxxx 1111 1111 1111 1100 0000 0000 1110 1111 1101 1000 0000 1011 0000 0100 1001 0010 1111 1011 1000 1111 01xx
                                                                 1 = Parity Flag
                                                                 0 = 1/2 Cycle Slip Flag
                                                                 011 1000 1111 = C/No
                                                                 111 1 = Lock Time
                                                                 010 1 = Pseudorange Std Deviation
                                                                 001 0 = Phaserange Std Deviation
                                                                 000 0000 1011 0000 0100 1 = Pseudo - 1st Pseudo
                                                                 00 0000 0000 1110 1111 1101 1 = Phase - Pseudo
1111 1111 1111 11
                                                                 = Doppler - 1st Doppler
    
```

Use *Table 139: Secondary Reference Signals Measurement Block* on page 685 to identify if a 2's Complement Conversion is needed as well as what Scale Factor should be used before these binary numbers are used in the following calculations.

- Parity flag is a 1 (Parity Known)
- 1/2 Cycle Slip flag is a 0 (Cycle Slip Not Present)
- C/No is:  
 $0x01110001111b = 911 \times \text{Scaling factor of } 0.05$   
 $= 45.55 \text{ dBHz}$
- The Lock Time value is:  
 $0x1111b = 15$  which means that this signal has been locked for 262144 ms or more.
- The Pseudorange Std Deviation value is:  
 $0x0101b = 5$  which means:  $0.099 \text{ m} < \text{PSR Std Dev} \leq 0.148 \text{ m}$  using *Table 145: Pseudorange Std Dev* on page 691.
- The ADR Std Deviation value is:  
 $0x0010b = 2$  which means:  $0.0052 < \text{ADR Std Dev} \leq 0.0070$  cycles using *Table 144: ADR Std Dev* on page 690.
- The L2Y Pseudorange is a 2's Complement number (as identified by the Range column in *Table 139: Secondary Reference Signals Measurement Block* on page 685) so it is processed in the following manner:  
 $\text{Pseudorange} - 1\text{st Pseudorange} = 2\text{'s Complement}(0x00000001011000001001b) \times \text{Scaling Factor}$   
 $\text{Pseudorange} - 21540290.811 \text{ m} = 5641 \times 0.0005$   
 $2Y \text{ Pseudorange} = 21540293.6315 \text{ m}$
- The L2Y Phaserange is a 2's Complement number (as identified by the Range column in *Table 139: Secondary Reference Signals Measurement Block* on page 685) so it is calculated in the following manner:  
 $\text{Phaserange} - \text{Pseudorange} = 2\text{'s Complement}(0x00000000001110111111011b) * \text{Scaling Factor}$   
 $\text{Phaserange} - 21540293.6315 \text{ m} = 7675 * 0.0001$   
 $L2Y \text{ Phaserange} = 21540294.399 \text{ m}$
- Convert this to ADR to check against the original RANGE log:  
 $\text{ADR} = \text{Phaserange} * \text{Frequency} * (-1) / \text{Speed Of Light}$   
 $\text{ADR} = 21540294.399 \text{ m} * 1227600000 \text{ Hz} * (-1) / 299792458 \text{ m/s}$   
 $L2Y \text{ ADR for PRN } 10 = -88203904.73002626 \text{ cycles}$



In the range logs, PSR and ADR have opposite signs.

- The L2Y Doppler is a 2's Complement number (as identified by the Range Column in *Table 139: Secondary Reference Signals Measurement Block* on page 685) so it is calculated in the following manner:

$$\begin{aligned} \text{Doppler(m/s)} - \text{1st Doppler(m/s)} &= 2's \text{ Complement}(0x1111111111111111b) \times \text{Scaling Factor} \\ \text{Doppler(m/s)} - (-435.5229 \text{ m/s}) &= (-1) \times 0.0001 \\ \text{L2Y Doppler(m/s)} &= -435.5228 \text{ m/s} \end{aligned}$$

Convert the Doppler to Hz:

$$\begin{aligned} \text{Doppler(Hz)} &= \text{Doppler(m/s)} \times \text{Frequency} \times (-1)/\text{Speed Of Light} \\ \text{Doppler(Hz)} &= -435.5228 \text{ m/s} \times 1227600000 \text{ Hz} \times (-1)/299792458 \text{ m/s} \\ \text{L2Y Doppler(Hz) for PRN 10} &= 1783.3938 \text{ Hz} \end{aligned}$$

### A.1.7 Reference Third Signals Measurement Block: GPS PRN 10 – L5Q

Signal L1CA was the 1st signal (Primary Signal) of the three PRN 10 signals found in this RANGEEMP4 log data. L1CA's data is now used to determine the L5Q's signals data. Since this is the third signal block of this PRN, its data will be processed using *Table 139: Secondary Reference Signals Measurement Block* on page 685.

With 4 bits left unprocessed from the previous byte, we will require  $82 - 4 = 78$  bits which rounds up to 10 bytes.

- Use the last byte (0x1f) plus grab the next 10 bytes (0x091f8214ff4d4d00a100) = 0x1f091f8214ff4d4d00a100
- Swap the bytes = 0x00a1004d4dff14821f091f
- 0x00a1004d4dff14821f091f in binary form =  
0000 0000 1010 0001 0000 0000 0100 1101 0100 1101 1111 1111 0001 0100 1000 0010 0001 1111 0000 1001 0001 1111
- Only need 78 bits. The 4 LSB's are ignored as they were already processed above and the 2 MSB's are ignored so there is a total of 82 bits to process

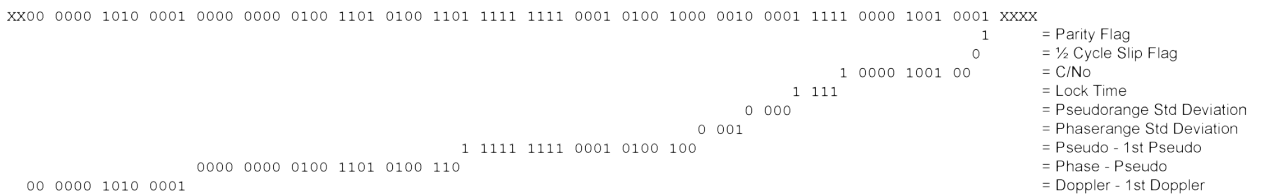

Use *Table 139: Secondary Reference Signals Measurement Block* on page 685 to identify if a 2's Complement Conversion is needed as well as what Scale Factor should be used before these binary numbers are used in the following calculations.

- Parity flag is a 1 (Parity Known)
- 1/2 Cycle Slip flag is a 0 (Cycle Slip Not Present)
- C/No is:  
 $0x10000100100b = 1060 \times \text{Scaling Factor of } 0.05 = 53.00 \text{ dBHz}$
- The Lock Time value is:  
 $0x1111b = 15$  which means that this signal has been locked for 262144 ms or more.
- The Pseudorange Std Deviation value is:  
 $0x0000b = 0$  which means: PSR Std Dev  $\leq 0.020 \text{ m}$  using *Table 145: Pseudorange Std Dev*



on page 691.

- The ADR Std Deviation value is:  
 $0x0001b = 1$  which means:  $0.0039 < \text{ADR Std Dev} \leq 0.0052$  cycles using *Table 144: ADR Std Dev* on page 690.
- The L5Q Pseudorange is a 2's Complement number (as identified by Range column in *Table 139: Secondary Reference Signals Measurement Block* on page 685) so it is processed in the following manner:  
Pseudorange – 1st Pseudorange = 2's Complement( $0x11111111100010100100b$ ) x Scaling Factor  
Pseudorange –  $21540290.811 \text{ m} = (-1884) \times 0.0005$   
L5Q Pseudorange =  $21540289.869 \text{ m}$
- The L5Q Phaserange is a 2's Complement number (as identified by the Range column in *Table 139: Secondary Reference Signals Measurement Block* on page 685) so it is calculated in the following manner:  
Phaserange – Pseudorange = 2's Complement( $0x00000000010011010100110b$ ) \* Scaling Factor  
Phaserange –  $21540289.869 \text{ m} = 9894 * 0.0001$   
L5Q Phaserange =  $21540290.8584 \text{ m}$
- Convert this to ADR to check against the original RANGE log:  
ADR = Phaserange \* Frequency \* (-1)/Speed Of Light  
ADR =  $21540290.8584 \text{ m} * 1176450000 \text{ Hz} * (-1)/299792458 \text{ m/s}$   
L5Q ADR for PRN 10 =  $-84528728.13886692$  cycles



In the range logs, PSR and ADR have opposite signs.

- The L5Q Doppler is a 2's Complement number (as identified by the Range column *Table 139: Secondary Reference Signals Measurement Block* on page 685) so it is calculated in the following manner:  
Doppler(m/s) – 1st Doppler(m/s) = 2's Complement( $0x00000010100001b$ ) x Scaling Factor  
Doppler(m/s) –  $(-435.5229 \text{ m/s}) = 80 \times 0.0001$   
L5Q Doppler(m/s) =  $-435.5149 \text{ m/s}$   
Convert the Doppler to Hz:  
Doppler(Hz) = Doppler(m/s) x Frequency \* (-1)/Speed Of Light  
Doppler(Hz) =  $-435.5149 \text{ m/s} \times 1176450000 \text{ Hz} * (-1)/299792458 \text{ m/s}$   
L5Q Doppler(Hz) for PRN 10 =  $1709.054 \text{ Hz}$

This concludes the processing of the signals present for PRN 10.

The next PRN as identified in the GPS Included Signals Field is PRN 15 with 2 signals. Processing of this data would be handled as described above, starting with the 4 bit Measurement Block followed by the individual signals. This would be followed by PRN 18, 21, and 27. Processing these remaining PRN's and their signals would use up the next 870 bits as shown below:

Bits required for remaining GPS PRN's and Signals:

PRN 15





mxn (Slot IDs x signals) parameters. Take the bit string and break it up into sets of 2 starting at the MSB. This will result with the lowest Slot ID being at the bottom row of the stack and the first signal (L1CA) being the far right column.

```

11
11
11
11
11

```

- This stack can be further broken apart to identify the Slot ID's vs. their Signals:

| SLOT | L2P | L1CA |
|------|-----|------|
| 24   | 1   | 1    |
| 18   | 1   | 1    |
| 17   | 1   | 1    |
| 2    | 1   | 1    |
| 1    | 1   | 1    |

### A.1.9 Reference Measurement Block Header: GLONASS PRN 38

(Slot 1 which was the first Slot found in the Satellites Field)

We will grab enough bytes to process the whole Measurement Block Header. Since this is a GLONASS System, a total of 9 bits will be required for this step (1 bit for the Data Format Flag, 3 bits for the Ref Data Block ID, plus 5 bits for the GLONASS Frequency Number).

With 2 bits left unprocessed from the previous byte, we will require  $9 - 2 = 7$  bits which rounds up to 1 byte:

- Use the last byte (0x3f) plus the next byte (0xa0) = 0x3fa0
- Swap the bytes = 0xa03f
- 0xa03f in binary form = 1010000000111111
- Ignore the 6 processed bits from the last step = 1010000000XXXXXX
- Ignore the 1 MSB bits leaving 9 bits for processing =

```

x010000000XXXXXX
  0           = Data Format Flag (1 bit)
 000         = Ref Data Block (3 bits)
01000       = GLONASS Freq Number (5 bits)

```

The Data Format Flag identifies that this batch of data is Reference (0) data.

The Ref Data Block ID is 0x000.

The GLONASS Frequency Number is 8 (adjusted to 1). When calculating the GLONASS Carrier frequency, this value (0 to 20) will be adjusted to its -7 to +13 value and then multiplied by that frequencies delta. Note that this field only appears in the Reference data and will not be found in the Differential data.



**Special Case:** When the Slot ID is between 43 and 63, the Slot ID of the GLONASS satellite is unknown. In order to keep track of which satellite it is for these calculations, the Frequency Number is used to assign this GLONASS Satellite a temporary Slot ID based on the GLONASS Frequency Numbers binary value of 0 to 20.

**A.1.10 Reference Primary Signal Measurement Block: GLONASS PRN 38 – L1CA**

The next bytes collected will be for the GLONASS PRN 38 - L1CA signal data. This is the primary signal of the satellite since it is the first signal. As a result, its Measurement Block consists of 111 bits as listed in *Table 138: Primary Reference Signal Measurement Block* on page 684. Since 111 bits takes up a lot of space, these bits will be split into two groups from *Table 138: Primary Reference Signal Measurement Block* on page 684: the top 25 bits for signal info followed by the bottom 86 bits for signal data.

The signal info section (top 25 bits) is processed as follows:

- With 1 bit left unprocessed from the previous byte, we calculate 25 – 1 = 24 bits which equals 3 bytes. Therefore the previous last byte (0xa0) plus the next 3 bytes will be needed.
  - Use the last byte (0xa0) plus grab 3 bytes (x19f813) = 0xa019f813
  - Swap the bytes = 0x13f819a0
  - 0x13f819a0 in binary form = 00010011111110000001100110100000
  - The previous step used the 7 LSB’s = 0001001111111000000110011XXXXXXX
  - Need 25 bits which is exactly what is left over:

```

0001001111111000000110011XXXXXXX
                                1           = Parity Flag
                                1           = ½ Cycle Slip Flag
                               10000001100   = C/No
                              1111         = Lock Time
                             0011         = Pseudorange Std Deviation
                            0001         = Phasorange Std Deviation
    
```

- Parity flag is a 1 (Parity Known)
- ½ Cycle Slip flag is a 1 (Cycle Slip Present)
- C/No is:
  - 0x10000001100b = 1036 x Scaling factor of 0.05
  - = 51.80 dBHz
- The Lock Time value is:
  - 0x1111b = 15 which means that this signal has been locked for 262144 ms or more.
- The Pseudorange Std Deviation value is:
  - 0x0011b = 3 which means: 0.045 m < PSR Std Dev <= 0.066 m using *Table 145: Pseudorange Std Dev* on page 691.
- The ADR Std Deviation value is:
  - 0x0001b = 1 which means: 0.0039 < ADR Std Dev <= 0.0052 cycles using *Table 144: ADR Std Dev* on page 690.

The signal data section (bottom 86 bits) is processed as follows:

- With no unprocessed bits from the previous byte, we need 86 bits which rounds up to 11 bytes.

- Grab 11 bytes = 0x6a11273649b8fcefab9c43
- Swap the bytes = 0x439cabeffcb8493627116a
- 0x439cabeffcb8493627116a in binary form =

```
0100 0011 1001 1100 1010 1011 1110 1111 1111 1100 1011 1000 0100 1001 0011 0110
0010 0111 0001 0001 0110 1010
```

- Only need 86 bits. Ignore first 2 MSB's =

```
xx00 0011 1001 1100 1010 1011 1110 1111 1100 1011 1000 0100 1001 0011 0110 0010 0111 0001 0001 0110 1010
                                0 1001 0011 0110 0010 0111 0001 0001 0110 1010 = 1st Pseudo
                                1111 1111 1100 1011 1000 010  = 1st Phase - 1st Pseudo
00 0011 1001 1100 1010 1011 1110 = 1st Doppler
```

- Use *Table 138: Primary Reference Signal Measurement Block* on page 684 to identify if a 2's Complement Conversion is needed as well as what Scale Factor should be used before these binary numbers are used in the following calculations.

- The 1st (Primary) Pseudorange is processed by:

1st Pseudorange = 0x0100100110110001001110001000101101010b x Scaling Factor  
 1st Pseudorange = 39563235690 x 0.0005  
 L1CA Pseudorange for PRN 38 = 19781617.845 m

- The 1st (Primary) Phaserange is a 2's Complement number (as identified by the Range column in *Table 138: Primary Reference Signal Measurement Block* on page 684) so it is processed in the following manner:

1st Phaserange - 1st Pseudorange = 2's Complement(0x11111111110010111000010b) \*  
 Scaling Factor  
 1st Phaserange - 19781617.845 m = -6718 \* 0.0001  
 L1CA Phaserange = 19781617.1732 m

- Convert this to ADR to check against the original RANGE log:

ADR = 1st Phaserange \* (Carrier Frequency + Frequency Number \* 562500 Hz) \* (-1)/Speed  
 Of Light  
 ADR = 19781617.1732 m \* (1602000000 Hz + 1 \* 562500 Hz) \* (-1)/299792458 m/s  
 ADR = 19781617.1732 m \* 1602562500 Hz \* (-1)/299792458 m/s  
 L1CA ADR for PRN 38 = -105744080.6970745 cycles

In the range logs, PSR and ADR have opposite signs.

- The 1st (Primary) Doppler is a 2's Complement number (as identified by the Range column in *Table 138: Primary Reference Signal Measurement Block* on page 684) so it is processed in the following manner:

1st Doppler(m/s) = 2's Complement(0x0000111001110010101010111110b) x Scaling Factor  
 1st Doppler(m/s) = 3787454 m/s x 0.0001  
 L1CA Doppler(m/s) = 378.7454 m/s

Convert the Doppler to Hz:





In this example the receiver was configured to track only GPS and GLONASS systems. If other systems had been in the configuration and tracked, they would have shown here.

### A.2.2 Differential Satellite and Signal Block

This block is sent once for each bit set to 1 in the GNSS field found in *Table 135: Header* on page 681. As identified by the above GNSS field, the first system (right to left) is the GPS System. Use *Table 136: Satellite and Signal Block* on page 682 to determine what satellites and signals data are contained in this GPS System:

*GPS Satellites field (64 bits)*

- Grab the next 8 bytes (64 bits) = 0x0042120400000000
- Swap the bytes = 0x...0000000004124200
- 0x0000000004124200 in binary form =

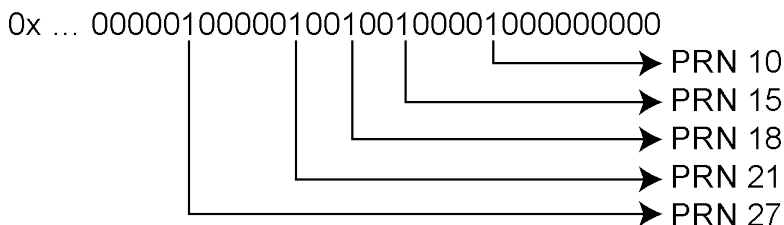

- The 1's above identify that there are 5 tracking GPS PRNs.

*GPS Signals field (16 bits)*

- Grab the next 2 bytes (16 bits) = 0x9200
- Swap the bytes = 0x0092
- 0x0092 in binary form =

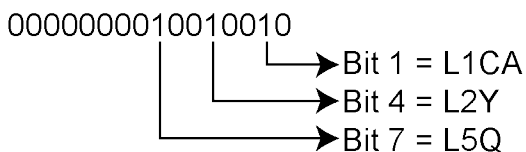

- The 1's above identify that there are 3 tracking GPS signals: L1CA, L2Y, and L5Q.

*GPS Included Signals field (5 PRNs x 3 Signals = 15 bits – therefore need 2 bytes)*

Up to the point of processing the Included Signals field, the bytes are aligned such that the bits start and end within each batch of bytes. After processing this step, it is quite common for the Included Signals field (mxn matrix) to not be divisible by 8 so bytes not processed will need to be carried over to the next section depending on the size of the matrix.

- Grab the next 2 bytes (16 bits) = 0xdff6
- Swap the bytes = 0xf6df
- 0xf6df in binary form = 1111011011011111
- Only need 15 of the 16 bits = X111011011011111
- This bit string breaks down into 5 rows (PRNs) and 3 columns (signals) as specified by the



mxn (PRN x signals) parameters. Take the bit string and break it up into sets of 3 starting at the MSB. This will result with the lowest PRN being at the bottom row of the stack and the first signal (L1CA) being the far right column.

```

111
011
011
011
111

```

- This stack can be further broken apart to identify the PRNs vs. their Signals:

| PRN | L5Q | L2Y | L1CA |
|-----|-----|-----|------|
| 27  | 1   | 1   | 1    |
| 21  | 0   | 1   | 1    |
| 18  | 0   | 1   | 1    |
| 15  | 0   | 1   | 1    |
| 10  | 1   | 1   | 1    |

### A.2.3 Differential Measurement Block Header

This block is sent once for each bit set to 1 in the Satellites field found in *Table 136: Satellite and Signal Block* on page 682. Now that the PRN's signals have been determined, the next step is to determine the specifics of the first PRN (10) and its list of signals (L1CA, L2Y, L5Q). Working from bottom right to upper left of the PRN/Signal chart above, each 1 represents a signal for a PRN. Use *Table 137: Measurement Block Header* on page 683 to determine the contents of each field:

*GPS PRN 10* (first PRN found in the Satellites field)

We will grab enough bytes to process the whole Measurement Block Header. If this was a GLONASS system, a total of 9 bits would be required at this step (1 bit for the Data Format Flag, 3 bits for the Ref Data Block ID, plus 5 bits for the GLONASS Frequency Number). Since this is a GPS system, only 4 bits in total are required (1 bit for the Data Format Flag and 3 bits for the Ref Data Block ID).

There was 1 bit not processed in the last byte so that byte will be carried forward. Only 4 bits need to be looked at for this step so grab the next byte as well:

- Use the last byte (0xf6) plus the next byte (0x88)= 0xf688
- Swap the bytes = 0x88f6
- 0x88f6 in binary form = 1000 1000 1111 0110
- Ignore the processed bits from the last step = 1000 1000 1XXX XXXX
- Ignore the 5 MSB bits leaving 4 bits for processing =

```

xxxx x000 1xxx xxxx
      1           = Data Format Flag (1 bit)
    000         = Ref Data Block (3 bits)

```

The Data Format Flag identifies that this batch of data is Differential (1) data.

The Ref Data Block ID is 0x000. The Ref Data Block ID here identifies that this differential data will be calculated from the Reference data that had a Ref Data Block ID equaling 000 (which was determined in the RANGEEMP4 log at time 507977.00 seconds).



The 5 MSB's have not been processed so this byte will be carried forward.

Logs between seconds will be Differential logs but could be Reference logs depending on the compression calculations. If a discontinuity occurred that made it impossible for a Differential calculation to fit within the Differential Constraints, it will revert to a Reference log.

#### **A.2.4 Differential Measurement Block**

This block is sent once for each bit set to 1 in the Included Signals field found in *Table 136: Satellite and Signal Block* on page 682. Use *Table 140: Primary Differential Signal Measurement Block* on page 686 and *Table 141: Secondary Differential Signals Measurement Block* on page 687 to determine the contents of each field:

A Measurement Block for a single PRN will look like the following:

Primary Parity Flag

Primary  $\frac{1}{2}$  Cycle Slip Flag

Primary C/No

Primary Lock Time

Primary Pseudorange Std Deviation

Primary Phaserange Std Deviation

Primary Pseudorange

Primary Phaserange - Primary Pseudorange (determines the Phaserange for the 1<sup>st</sup> Signal)

Primary Doppler

2<sup>nd</sup> Parity Flag

2<sup>nd</sup>  $\frac{1}{2}$  Cycle Slip Flag

2<sup>nd</sup> C/No

2<sup>nd</sup> Lock Time

2<sup>nd</sup> Pseudorange Std Deviation

2<sup>nd</sup> Phaserange Std Deviation

2<sup>nd</sup> Pseudorange - Primary Pseudorange (determines the Pseudorange for the 2<sup>nd</sup> Signal)

2<sup>nd</sup> Phaserange - 2<sup>nd</sup> Pseudorange (determines the Phaserange for the 2<sup>nd</sup> Signal)

2<sup>nd</sup> Doppler - Primary Doppler (determines the Doppler for the 2<sup>nd</sup> Signal)

3<sup>rd</sup> Parity Flag

3<sup>rd</sup>  $\frac{1}{2}$  Cycle Slip Flag

3<sup>rd</sup> C/No

3<sup>rd</sup> Lock Time

3<sup>rd</sup> Pseudorange Std Deviation

3<sup>rd</sup> Phaserange Std Deviation

3<sup>rd</sup> Pseudorange - Primary Pseudorange (determines the Pseudorange for the 3<sup>rd</sup> Signal)

3<sup>rd</sup> Phaserange - 3<sup>rd</sup> Pseudorange (determines the Phaserange for the 3<sup>rd</sup> Signal)

3<sup>rd</sup> Doppler - Primary Doppler (determines the Doppler for the 3<sup>rd</sup> Signal)

...

### A.2.5 Differential Primary Signal Measurement Block GPS PRN 10 - L1CA

The next bytes collected will be for the GPS PRN 10 - L1CA signal data. Since this is the primary signal of the PRN, its Measurement Block consists of 78 bits as listed in *Table 140: Primary Differential Signal Measurement Block* on page 686.

The signal info section (top 25 bits) is processed as follows:

- With 5 bits left from the previous byte, we calculate  $25 - 5 = 20$  bits which rounds up to 3 bytes. Therefore the previous last byte (0x88) plus the next 3 bytes will be needed.
  - Use the last byte (0x88) plus grab 3 bytes (x831f61) = 0x88831f61
  - Swap the bytes = 0x611f8388
  - 0x611f8388 in binary form  
= 0110 0001 0001 1111 1000 0011 1000 1000
  - Only need 25 bits. The last byte uses the 5 MSB's and the first byte ignores the 4 MSB's  
 XXXX 0001 0001 1111 1000 0011 1000 1XXX  
 1 = Parity Flag  
 0 = ½ Cycle Slip Flag  
 1000 0011 100 = C/No  
 1111 = Lock Time  
 0001 = Pseudorange Std Deviation  
 0001 = Phaserange Std Deviation
- Parity flag is a 1 (Parity Known)
- ½ Cycle Slip flag is a 0 (Cycle Slip Not Present)
- C/No is:  
0x10000011100b = 1052 x Scaling factor of 0.05  
= 52.60 dBHz
- The Lock Time value is:  
0x1111b = 15 which means that this signal has been locked for 262144 ms or more.
- The Pseudorange Std Deviation value is:  
0x0001b = 1 which means:  $0.020 \text{ m} < \text{PSR Std Dev} \leq 0.030 \text{ m}$  using *Table 145: Pseudorange Std Dev* on page 691.
- The ADR Std Deviation value is:  
0x0001b = 1 which means:  $0.0039 < \text{ADR Std Dev} \leq 0.0052$  cycles using *Table 144: ADR Std Dev* on page 690Table 10.

- For the following calculations, the time difference between the Differential Log and the Reference log is 0.25 seconds as shown below:  
 Time Difference = Current Log Time – Reference log Time  
 = 507977.250 - 507977.000  
 = 0.250 seconds

The signal data section (bottom 53 bits) is processed as follows:

- With 4 bits unprocessed from the previous byte, we calculate  $53 - 4 = 49$  bits = 7 bytes (7 bits will not be processed in the last byte).

- Use the last byte (0x61) plus grab 7 bytes (0x02005500e70162)  
 = 0x6102005500e70162

- Swap the bytes = 0x6201e70055000261

- 0x6201e70055000261 in binary form =

0110 0010 0000 0001 1110 0111 0000 0000 0101 0101 0000 0000 0000 0010 0110 0001

- Only need 53 bits. Ignore last 4 LSB's and first 7 MSB's =

```

xxxx xxx0 0000 0001 1110 0111 0000 0000 0101 0101 0000 0000 0000 0010 0110 xxxx
                                000 0000 0000 0010 0110           = 1st Pseudo - Predicted Pseudo
                                000 0000 0101 0101 0           = 1st Phase - Predicted Phase
0 0000 0001 1110 0111 0                                         = 1st Doppler - Ref Doppler
    
```

- Use *Table 140: Primary Differential Signal Measurement Block* on page 686 to identify if a 2's Complement Conversion is needed as well as what Scale Factor should be used before these binary numbers are used in the following calculations.

- The 1st (Primary) Differential Pseudorange is processed by:

$$\begin{aligned} \text{Predicted Pseudorange} &= \text{Reference 1st Pseudorange} + (\text{1st Doppler} \times \text{TimeDifference}) \\ &= 21540181.930275 \text{ m} \\ &= 21540290.811 \text{ m} + ((-435.5229 \text{ m/s}) \times 0.250 \text{ s}) \end{aligned}$$

$$\text{1st DiffPseudorange} - \text{Predicted Pseudorange} = 0x0000000000000100110b \times \text{Scaling Factor}$$

$$\text{1st DiffPseudorange} - 21540181.930275 \text{ m} = 38 \times 0.0005$$

$$\text{L1CA Pseudorange for PRN 10} = 21540181.949275 \text{ m}$$

- The 1st (Primary) Differential Phaserange is a 2's Complement number (as identified by the Range column in *Table 140: Primary Differential Signal Measurement Block* on page 686) so it is processed in the following manner:

$$\begin{aligned} \text{Predicted Phaserange} &= \text{Reference 1st DiffPhaserange} + (\text{1st Doppler} \times \text{TimeDifference}) \\ &= 21540291.5622 \text{ m} + ((-435.5229 \text{ m/s}) \times 0.250 \text{ s}) \\ &= 21540182.681475 \text{ m} \end{aligned}$$

$$\text{1st DiffPhaserange} - \text{Predicted Phaserange} = 2\text{'s Complement}(0x0000000010101010b) * \text{Scaling Factor}$$

$$\text{1st DiffPhaserange} - 21540182.681475 \text{ m} = 170 * 0.0001$$

$$\text{L1CA Phaserange} = 21540182.698475 \text{ m}$$

- Convert this to ADR to check against the original RANGE log:

$$\text{ADR} = \text{1st DifPhaserange} * \text{Frequency} * (-1) / \text{Speed Of Light}$$

$$\text{ADR} = 21540182.698475 \text{ m} * 1575420000 \text{ Hz} * (-1) / 299792458 \text{ m/s}$$

$$\text{L1CA ADR for PRN 10} = -113194424.0799796 \text{ cycles}$$



In the range logs, PSR and ADR have opposite signs.

- The 1st (Primary) Differential Doppler is a 2's Complement number (as identified by the Range column in *Table 140: Primary Differential Signal Measurement Block* on page 686) so it is processed in the following manner:

1st DiffDoppler(m/s)- Reference 1st Doppler = 2's Complement(0x000000001111001110b) x Scaling Factor

1st DiffDoppler(m/s) - (-435.5229 m/s) = 974 x 0.0001

L1CA Doppler(m/s) = -435.4255 m/s

Convert the Doppler to Hz:

1st DiffDoppler(Hz) = 1st DiffDoppler(m/s) x Frequency \* (-1)/Speed Of Light

1st DiffDoppler(Hz) = -435.4255 m/s x 1575420000 Hz \* (-1)/299792458 m/s

L1CA Doppler(Hz) for PRN 10 = 2288.1764464 Hz

### A.2.6 Differential Secondary Signals Measurement Block GPS PRN 10 – L2Y

Unlike Reference logs which always reflect back to the initial signal for their computations, Differential logs uses the last Reference log data of the same signal for its calculations.

- With 7 bits unprocessed from the previous byte, we will require 74 - 7 = 67 bits which rounds up to 9 bytes.
  - Use the last byte (0x62) plus grab the next 9 bytes (0xdc977c004015c07988) = 0x62dc977c004015c07988
  - Swap the bytes = 0x8879c01540007c97dc62
  - 0x8879c01540007c97dc62 in binary form =  
1000 1000 0111 1001 1100 0000 0001 0101 0100 0000 0000 0000 0111 1100 1001 0111 1101 1100 0110 0010
  - Only need 74 bits. The 1 LSB is ignored as it was already processed above and the 5 MSB's are ignored so there is a total of 74 bits to process

```

XXXXXXXX 0111 1001 1100 0000 0001 0101 0100 0000 0000 0000 0111 1100 1001 0111 1101 1100 0110 001X
                                                                                               1 = Parity Flag
                                                                                               0 = ½ Cycle Slip Flag
                                                                                               01 1100 0110 0 = C/No
                                                                                               11 11 = Lock Time
                                                                                               01 01 = Pseudorange Std Deviation
                                                                                               00 10 = Phasorange Std Deviation
                                                                                               0 0000 0000 0000 0111 11 = Pseudo - Predicted Pseudo
                                                                                               0 0000 0001 0101 010 = Phase - Predicted Phase
000 0111 1001 110                                                                                               = Doppler - Ref Doppler
    
```

- Parity flag is a 1 (Parity Known)
- ½ Cycle Slip flag is a 0 (Cycle Slip Not Present)
- C/No is:  
0x01110001100b = 908 x Scaling Factor of 0.05  
= 45.4 dBHz
- The Lock Time value is:  
0x1111b = 15 which means that this signal has been locked for 262144 ms or more.
- The Pseudorange Std Deviation value is:

0x0101b = 5 which means:  $0.099 \text{ m} < \text{PSR Std Dev} \leq 0.148 \text{ m}$  using *Table 145: Pseudorange Std Dev* on page 691.

- The ADR Std Deviation value is:  
0x0010b = 2 which means:  $0.0052 < \text{ADR Std Dev} \leq 0.0070$  cycles using *Table 144: ADR Std Dev* on page 690.

- The L2Y Pseudorange is a 2's Complement number (as identified by the Range column in *Table 141: Secondary Differential Signals Measurement Block* on page 687) so it is processed in the following manner:

$$\begin{aligned} \text{Predicted Pseudorange} &= \text{Reference 2nd Pseudorange} + (\text{2nd Doppler} \times \text{TimeDifference}) \\ &= 21540293.6315 \text{ m} + ((-435.523 \text{ m/s}) \times 0.250 \text{ s}) \\ &= 21540184.75075 \text{ m} \end{aligned}$$

DiffPseudorange – Predicted Pseudorange = 2's Complement(0x0000000000000011111b) x Scaling Factor

$$\text{DiffPseudorange} - 21540184.75075 \text{ m} = 31 \times 0.0005$$

$$\text{L2Y Pseudorange} = 21540184.76625 \text{ m}$$

- The L2Y Phaserange is a 2's Complement number (as identified by the Range column in *Table 141: Secondary Differential Signals Measurement Block* on page 687) so it is calculated in the following manner:

$$\begin{aligned} \text{Predicted Phaserange} &= \text{Reference 2nd DiffPhaserange} + (\text{2nd Doppler} \times \text{TimeDifference}) \\ &= 21540294.399 \text{ m} + ((-435.523 \text{ m/s}) \times 0.250 \text{ s}) \\ &= 21540185.51825 \text{ m} \end{aligned}$$

DiffPhaserange – Predicted Phaserange = 2's Complement(0x0000000010101010b) \* Scaling Factor

$$\text{DiffPhaserange} - 21540185.51825 \text{ m} = 170 * 0.0001$$

$$\text{L2Y Phaserange} = 21540185.53525 \text{ m}$$

- Convert this to ADR to check against the original RANGE log:

$$\text{ADR} = \text{Phaserange} * \text{Frequency} * (-1)/\text{Speed Of Light}$$

$$\text{ADR} = 21540185.53525 \text{ m} * 1227600000 \text{ Hz} * (-1)/299792458 \text{ m/s}$$

$$\text{L2Y ADR for PRN 10} = -88203458.95116848 \text{ cycles}$$



In the range logs, PSR and ADR have opposite signs.

- The L2Y Doppler is a 2's Complement number (as identified by the Range column in *Table 141: Secondary Differential Signals Measurement Block* on page 687) so it is calculated in the following manner:

DiffDoppler(m/s) – Ref 2nd Doppler(m/s) = 2's Complement(0x00001111001110b) x Scaling Factor

$$\text{DiffDoppler(m/s)} - (-435.5229 \text{ m/s}) = (974) \times 0.0001$$

$$\text{L2Y Doppler(m/s)} = -435.4255 \text{ m/s}$$

Convert the Doppler to Hz:

$$\text{Doppler(Hz)} = \text{Doppler(m/s)} \times \text{Frequency} * (-1)/\text{Speed Of Light}$$

$$\text{Doppler(Hz)} = -435.4255 \text{ m/s} \times 1227600000 \text{ Hz} * (-1)/299792458 \text{ m/s}$$

$$\text{L2Y Doppler(Hz) for PRN 10} = 1782.994633 \text{ Hz}$$

### A.2.7 Differential Third Signals Measurement Block GPS PRN 10 – L5Q

Unlike Reference logs which always reflect back to the initial signal for their computations, Differential logs uses the last Reference log data of the same signal for its calculations.

- With 3 bits unprocessed from the previous byte, we will require  $74 - 3 = 71$  bits which rounds up to 9 bytes.
  - Use the last byte (0x88) plus grab the next 9 bytes (0x 840f6101803a805921) = 0x88840f6101803a805921
  - Swap the bytes = 0x2159803a8001610f8488
  - 0x2159803a8001610f8488 in binary form =  
0010 0001 0101 1001 1000 0000 0011 1010 1000 0000 0000 0001 0110 0001 0000 1111  
1000 0100 1000 1000
  - Only need 74 bits. The 3 LSB's are ignored as they were already processed and the 3 MSB's are ignored so there is a total of 74 bits to process

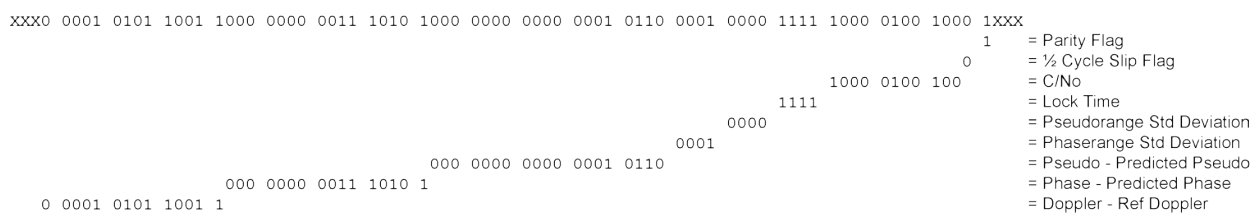

- Parity flag is a 1 (Parity Known)
- 1/2 Cycle Slip flag is a 0 (Cycle Slip Not Present)
- C/No is:  
 $0x10000100100b = 1060 \times \text{Scaling factor of } 0.05 = 53.0 \text{ dBHz}$
- The Lock Time value is:  
 $0x1111b = 15$  which means that this signal has been locked for 262144 ms or more.
- The Pseudorange Std Deviation value is:  
 $0x0000b = 0$  which means: PSR Std Dev  $\leq 0.020$  m using *Table 145: Pseudorange Std Dev* on page 691.
- The ADR Std Deviation value is:  
 $0x0001b = 1$  which means:  $0.0039 < \text{ADR Std Dev} \leq 0.0052$  cycles using *Table 144: ADR Std Dev* on page 690.
- The L5Q Pseudorange is a 2's Complement number (as identified by the Range column in *Table 141: Secondary Differential Signals Measurement Block* on page 687) so it is processed in the following manner:  

$$\begin{aligned} \text{Predicted Pseudorange} &= \text{Reference 3rd Pseudorange} + (\text{3rd Doppler} \times \text{TimeDifference}) \\ &= 21540289.869 \text{ m} + ((-435.5149 \text{ m/s}) \times 0.250 \text{ s}) \\ &= 21540180.990275 \text{ m} \end{aligned}$$

$$\begin{aligned} \text{DiffPseudorange} - \text{Predicted Pseudorange} &= 2\text{'s Complement}(0x000\ 0000\ 0000\ 0001\ 0110b) \\ &\times \text{Scaling Factor} \\ \text{DiffPseudorange} - 21540180.990275 \text{ m} &= 22 \times 0.0005 \\ \text{L5Q Pseudorange} &= 21540181.001275 \text{ m} \end{aligned}$$
- The L5Q Phaserange is a 2's Complement number (as identified by the Range column in

*Table 141: Secondary Differential Signals Measurement Block* on page 687) so it is calculated in the following manner:

$$\begin{aligned} \text{Predicted Phaserange} &= \text{Reference 3rd DiffPhaserange} + (\text{3rd Doppler} \times \text{TimeDifference}) \\ &= 21540290.8584 \text{ m} + ((-435.5149 \text{ m/s}) \times 0.250 \text{ s}) \\ &= 21540181.979675 \text{ m} \end{aligned}$$

$\text{DiffPhaserange} - \text{Predicted Phaserange} = 2\text{'s Complement}(0x000000001110101b) \times \text{Scaling Factor}$

$$\text{DiffPhaserange} - 21540181.979675 \text{ m} = 117 \times 0.0001$$

$$\text{L5Q Phaserange} = 21540181.991375 \text{ m}$$

- Convert this to ADR to check against the original RANGE log:

$$\text{ADR} = \text{Phaserange} \times \text{Frequency} \times (-1)/\text{Speed Of Light}$$

$$\text{ADR} = 21540181.991375 \text{ m} \times 1176450000 \text{ Hz} \times (-1)/299792458 \text{ m/s}$$

$$\text{L5Q ADR for PRN 10} = -84528300.92127641 \text{ cycles}$$



In the range logs, PSR and ADR have opposite signs.

- The L5Q Doppler is a 2's Complement number (as identified by the Range column in *Table 141: Secondary Differential Signals Measurement Block* on page 687) so it is calculated in the following manner:

$\text{DiffDoppler(m/s)} - \text{Ref 3rd Doppler(m/s)} = 2\text{'s Complement}(0x00001010110011b) \times \text{Scaling Factor}$

$$\text{DiffDoppler(m/s)} - (-435.5149 \text{ m/s}) = 691 \times 0.0001$$

$$\text{L5Q Doppler(m/s)} = -435.4458 \text{ m/s}$$

Convert this to Hz:

$$\text{Doppler(Hz)} = \text{Doppler(m/s)} \times \text{Frequency} \times (-1)/\text{Speed Of Light}$$

$$\text{Doppler(Hz)} = -435.4458 \text{ m/s} \times 1176450000 \text{ Hz} \times (-1)/299792458 \text{ m/s}$$

$$\text{L5Q Doppler(Hz) for PRN 10} = 1708.78285 \text{ Hz}$$

This concludes the decoding of the Differential Log for PRN 10 (signals L1CA, L2Y, and L5Q). The rest of the decoding for the other PRN's and systems are handled in the same manner.



