



Agriculture Commands and Logs Reference Manual

Agriculture Comands and Logs Reference Manual

Publication Number: OM-20000183

Revision Level: v6

Revision Date: October 2019

Firmware Versions:

- 7.06.03 / OA7CR0603RN0000

Proprietary Notice

Information in this document is subject to change without notice and does not represent a commitment on the part of NovAtel Inc. The information contained within this manual is believed to be true and correct at the time of publication.

NovAtel, ALIGN, GLIDE, GrafNav/GrafNet, Inertial Explorer, NovAtel CORRECT, OEM7, PwrPak7, RELAY, SPAN, STEADYLINE, VEXXIS and Waypoint are registered trademarks of NovAtel Inc.

NovAtel Connect, OEM719, OEM729, OEM7500, OEM7600, OEM7700, OEM7720, SMART7, SMART2, RELAY7 and RTK ASSIST are trademarks of NovAtel Inc.

All other brand names are trademarks of their respective holders.

© Copyright 2019 NovAtel Inc. All rights reserved. Unpublished rights reserved under International copyright laws.

Table of Contents

Figures

Tables

Customer Support

Foreword

Chapter 1 Messages

1.1	ASCII	29
1.2	Abbreviated ASCII	30
1.3	Binary	31
1.4	Description of ASCII and Binary Logs with Short Headers	42
1.5	Message Responses	42
1.5.1	Abbreviated ASCII Response	43
1.5.2	ASCII Response	43
1.5.3	Binary Response	43
1.6	GLONASS Slot and Frequency Numbers	45
1.6.1	PRN Numbers	46
1.7	GPS Reference Time Status	46
1.8	Message Time Stamps	47
1.9	Decoding of the GPS Reference Week Number	48
1.10	32-Bit CRC	48

Chapter 2 Agriculture GNSS Commands

2.1	Command Formats	52
2.1.1	Optional Parameters	52
2.2	Command Settings	52
2.3	Command Defaults	53
2.4	ALIGNAUTOMATION	54
2.5	ASSIGN	56
2.6	ASSIGNALL	59
2.7	ASSIGNLBANDBEAM	61
2.8	AUTH	63
2.9	AUTOSURVEY	66
2.10	BASEANTENNAPCO	69
2.11	BASEANTENNAPCV	71
2.12	BASEANTENNATYPE	72
2.13	BDSECUTOFF	83
2.14	BESTVELTYPE	85
2.15	BLUETOOTHCONTROL	86

2.16	CANCONFIG	87
2.17	CCOMCONFIG	89
2.18	CLOCKCALIBRATE	92
2.19	COMCONTROL	95
2.20	CONFIGCODE	98
2.21	DATUM	100
2.22	DATUMTRANSFORMATION	102
2.23	DGPSTXID	105
2.24	DNSCONFIG	106
2.25	DYNAMICS	107
2.26	ECHO	109
2.27	ECUTOFF	112
2.28	ELEVATIONCUTOFF	114
2.29	ETHCONFIG	117
2.30	EVENTINCONTROL	119
2.31	EVENTOUTCONTROL	121
2.32	FIX	124
2.33	FRESET	127
2.34	GALECUTOFF	130
2.35	GENERATEALIGNCORRECTIONS	132
2.36	GENERATEDIFFCORRECTIONS	134
2.37	GENERATERTKCORRECTIONS	135
2.38	GEODETICDATUM	137
2.39	GGAQUALITY	139
2.40	GLIDEINITIALIZATIONPERIOD	141
2.41	GLOECUTOFF	142
2.42	HDTOUTTHRESHOLD	144
2.43	HEADINGOFFSET	145
2.44	ICOMCONFIG	146
2.45	INTERFACEMODE	148
2.45.1	SPAN Systems	148
2.46	IPCONFIG	154
2.47	IPSERVICE	156
2.48	ITBANDPASSCONFIG	158
2.49	ITDETECTCONFIG	160
2.50	ITFRONTENDMODE	162
2.51	ITPROGFILTCONFIG	164
2.52	ITSPECTRALANALYSIS	166
2.53	J1939CONFIG	170
2.54	LOCKOUT	172
2.55	LOCKOUTSYSTEM	173
2.56	LOG	174

2.56.1 Binary	175
2.56.2 ASCII	178
2.57 LOGIN	180
2.58 LOGOUT	182
2.59 LUA	183
2.60 MAGVAR	185
2.61 MODEL	188
2.62 MOVINGBASESTATION	189
2.63 NAVICECUTOFF	191
2.64 NMEAFORMAT	193
2.65 NMEATALKER	196
2.66 NMEAVERSION	198
2.67 NTRIPCONFIG	199
2.68 NTRIPSOURCETABLE	201
2.69 NVMRESTORE	202
2.70 NVMUSERDATA	203
2.71 OUTPUTDATUM	204
2.72 PDPFILTER	206
2.72.1 GLIDE Position Filter	206
2.73 PDPMODE	208
2.74 \$PMDT	209
2.75 POSAVE	211
2.76 POSTIMEOUT	213
2.77 PPPBASICCONVERGEDCRITERIA	214
2.78 PPPCONVERGEDCRITERIA	215
2.79 PPPDYNAMICS	216
2.80 PPPRESET	217
2.81 PPPSEED	218
2.82 PPPSOURCE	220
2.83 PPPTIMEOUT	221
2.84 PPSCONTROL	222
2.85 PSRDIFFSOURCE	224
2.86 PSRDIFFSOURCETIMEOUT	226
2.87 PSRDIFFTIMEOUT	227
2.88 QZSSECUTOFF	228
2.89 RADARCONFIG	230
2.90 REFERENCESTATIONTIMEOUT	232
2.91 RESET	233
2.92 RTKASSIST	234
2.93 RTKASSISTTIMEOUT	235
2.94 RTKDYNAMICS	236
2.95 RTKINTEGERCRITERIA	237

2.96	RTKNETWORK	238
2.97	RTKPORTMODE	241
2.98	RTKRESET	243
2.99	RTKSOURCE	244
2.100	RTKSOURCETIMEOUT	246
2.101	RTKSVENTRIES	247
2.102	RTKTIMEOUT	248
2.103	SATEL4CONFIG	249
2.104	SATEL9CONFIG	253
2.105	SATEL9CONFIGL	255
2.106	SATEL9CONFIGN	257
2.107	SATELCONTROL	259
2.108	SATELDETECT	260
2.109	SATELSTARTUPDETECT	261
2.110	SAVECONFIG	262
2.111	SAVEETHERNETDATA	263
2.112	SBASCONTROL	265
2.113	SBASECUTOFF	268
2.114	SBASTIMEOUT	269
2.115	SELECTCHANCONFIG	270
2.116	SEND	274
2.117	SERIALCONFIG	276
2.118	SERIALPROTOCOL	279
2.119	SETADMINPASSWORD	281
2.120	SETAPPROXPOS	282
2.121	SETAPPROXTIME	283
2.122	SETBESTPOSCRITERIA	285
2.123	SETIONOTYPE	286
2.124	SETROVERID	287
2.125	SETUTCLEAPSECONDS	288
2.126	SOFTLOADCOMMIT	289
2.127	SOFTLOADDATA	290
2.128	SOFTLOADRESET	291
2.129	SOFTLOADSETUP	292
2.130	SOFTLOADSREC	294
2.131	STEADYLINE	295
2.132	STEADYLINEDIFFERENTIALTIMEOUT	297
2.133	SURVEYPOSITION	298
2.134	TECTONICSCOMPENSATIONSOURCE	300
2.135	TERRASTARAUTOCHANCONFIG	301
2.136	THISANTENNAPCO	302

2.137	THISANTENNAPCV	303
2.138	THISANTENNATYPE	304
2.139	TILTCOMPENSATIONCONTROL	305
2.140	TILTFILTER	306
2.141	TILTZERO	307
2.142	TRACKSV	308
2.143	TUNNELESCAPE	310
2.144	UALCONTROL	312
2.145	UNASSIGN	314
2.146	UNASSIGNALL	316
2.147	UNDULATION	317
2.148	UNLOCKOUT	319
2.149	UNLOCKOUTALL	320
2.150	UNLOCKOUTSYSTEM	321
2.151	UNLOG	322
2.151.1	Binary	322
2.151.2	ASCII	323
2.152	UNLOGALL	324
2.153	USERDATUM	325
2.154	USEREXPDATUM	327
2.155	USERI2CREAD	330
2.156	USERI2CWRITE	332
2.157	WIFIALIGNAUTOMATION	335
2.158	WIFIAPCHANNEL	337
2.159	WIFIAPCONFIG	338
2.160	WIFIAPPASSKEY	339
2.161	WIFIAPSSID	340
2.162	WIFIMODE	341
2.163	WIFINETCONFIG	343

Chapter 3 Logs

3.1	Log Types	346
3.1.1	Log Type Examples	346
3.2	ALIGNBSLNENU	348
3.3	ALIGNBSLNXYZ	350
3.4	ALIGNDOP	352
3.5	ALMANAC	353
3.6	AUTHCODES	356
3.7	AVEPOS	358
3.8	BDSALMANAC	360
3.9	BDSCLOCK	362
3.10	BDSEPHEMERIS	364

3.11	BDSIONO	366
3.12	BDSRAWNAVSUBFRAME	367
3.13	BESTDATUMINFO	368
3.14	BESTGNSSDATUMINFO	370
3.15	BESTPOS	371
3.16	BESTSATS	380
3.17	BESTUTM	384
3.18	BESTVEL	387
3.19	BESTXYZ	390
3.20	BSLNXYZ	393
3.21	CHANCONFIGLIST	395
3.22	CLOCKMODEL	399
3.23	CLOCKSTEERING	401
3.24	DATUMTRANSFORMATIONS	404
3.25	ETHSTATUS	406
3.26	GALALMANAC	407
3.27	GALCLOCK	409
3.28	GALCNAVRAWPAGE	411
3.29	GALFNAVEPHEMERIS	412
3.30	GALFNAVRAWPAGE	414
3.31	GALINAVEPHEMERIS	415
3.32	GALINAVRAWWORD	418
3.33	GALIONO	420
3.34	GEODETICDATUMS	421
3.35	GLMLA	423
3.36	GLOALMANAC	426
3.37	GLOCLOCK	429
3.38	GLOEPHEMERIS	431
3.39	GLORAWALM	435
3.40	GLORAWEPHEM	437
3.41	GLORAWFRAME	439
3.42	GLORAWSTRING	441
3.43	GPALM	442
3.44	GPGGA	444
3.45	GPGGALONG	447
3.46	GPGLL	449
3.47	GPGRS	451
3.48	GPGSA	453
3.49	GPGST	455
3.50	GPGSV	457
3.51	GPHDT	459

3.52	GPRMC	460
3.53	GPSEPHM	462
3.54	GPVTG	466
3.55	GPZDA	468
3.56	HEADING2	469
3.57	HEADINGEXT	472
3.58	HEADINGEXT2	473
3.59	HEADINGRATE	474
3.60	HEADINGSATS	476
3.61	HWMONITOR	479
3.62	IONUTC	482
3.63	IPSTATS	484
3.64	IPSTATUS	485
3.65	ITBANDPASSBANK	487
3.66	ITDETECTSTATUS	489
3.67	ITFILTABLE	491
3.68	ITPROGFILTBANK	495
3.69	ITPSDFINAL	497
3.70	J1939STATUS	500
3.71	LBANDBEAMTABLE	502
3.72	LBANDTRACKSTAT	504
3.73	LOGLIST	507
3.73.1	Binary	507
3.73.2	ASCII	508
3.74	LUAFILELIST	510
3.75	LUAFILESYSTEMSTATUS	512
3.76	LUAOUTPUT	513
3.77	LUASTATUS	514
3.78	MARKPOS, MARK2POS, MARK3POS and MARK4POS	515
3.79	MARK1TIME, MARK2TIME, MARK3TIME and MARK4TIME	518
3.80	MASTERPOS	521
3.81	MATCHEDPOS	523
3.82	MATCHEDSATS	526
3.83	MATCHEDXYZ	528
3.84	MODELFEATURES	530
3.85	NAVICALMANAC	533
3.86	NAVICEPHEMERIS	535
3.87	NAVICIONO	538
3.88	NAVICRAWSUBFRAME	540
3.89	NAVICSYSCLOCK	541
3.90	NMEA Standard Logs	543
3.91	NOVATELXOBS	546

3.92	NOVATELXREF	547
3.93	OCEANIXINFO	548
3.94	OCEANIXSTATUS	550
3.95	PASSCOM, PASSAUX, PASSUSB, PASSETH1, PASSICOM, PASSNCOM	552
3.96	PASSTHROUGH	557
3.97	PDPDOP	558
3.98	PDPDOP2	560
3.99	PDPPOS	562
3.100	PDPSATS	564
3.101	PDPVEL	566
3.102	PDPXYZ	567
3.103	PORTSTATS	569
3.104	PPPDATUMINFO	571
3.105	PPPPOS	572
3.106	PPPSATS	574
3.107	PPPSEEDAPPLICATIONSTATUS	576
3.108	PPPSEEDSTORESTATUS	578
3.109	PROFILEINFO	579
3.110	PSRDOP	581
3.111	PSRDOP2	583
3.112	PSRPOS	585
3.113	PSRSATS	587
3.114	PSRVEL	589
3.115	PSRXYZ	591
3.116	QZSSALMANAC	594
3.117	QZSSEPHEMERIS	596
3.118	QZSSIONUTC	599
3.119	QZSSRAWALMANAC	601
3.120	QZSSRAWCNAVMESSAGE	603
3.121	QZSSRAWEPHEM	604
3.122	QZSSRAWSUBFRAME	605
3.123	RADARSTATUS	606
3.124	RAIMSTATUS	608
3.125	RANGE	611
3.126	RANGECMP	619
3.127	RANGECMP2	623
3.128	RANGECMP4	631
3.129	RANGEGPSL1	643
3.130	RAWALM	645
3.131	RAWCNAVFRAME	647
3.132	RAWEPHEM	648

3.133	RAWGPSSUBFRAME	650
3.134	RAWGPSWORD	652
3.135	RAWSBASFRAME	653
3.136	RAWSBASFRAME2	655
3.137	REFSTATION	657
3.138	REFSTATIONINFO	659
3.139	ROVERPOS	661
3.140	RTCMV3 Standard Logs	663
3.140.1	Legacy Observable Messages	663
3.140.2	MSM Observable Messages	664
3.140.3	Station and Antenna Messages	665
3.140.4	Ephemeris Messages	666
3.141	RTKASSISTSTATUS	668
3.142	RTKDOP	670
3.143	RTKDOP2	672
3.144	RTKPOS	674
3.145	RTKSATS	677
3.146	RTKVEL	679
3.147	RTKXYZ	681
3.148	RXCONFIG	684
3.149	RXSTATUS	686
3.150	RXSTATUSEVENT	699
3.151	SAFEMODESTATUS	702
3.152	SATEL4INFO	705
3.153	SATEL9INFO	707
3.154	SATELSTATUS	710
3.155	SATVIS2	712
3.156	SATXYZ2	715
3.157	SAVEDSURVEYPOSITIONS	718
3.158	SBAS0	720
3.159	SBAS1	721
3.160	SBAS2	722
3.161	SBAS3	725
3.162	SBAS4	727
3.163	SBAS5	729
3.164	SBAS6	731
3.165	SBAS7	734
3.166	SBAS9	737
3.167	SBAS10	739
3.168	SBAS12	741
3.169	SBAS17	743
3.170	SBAS18	745

3.171	SBAS24	747
3.172	SBAS25	750
3.173	SBAS26	753
3.174	SBAS27	755
3.175	SBAS32	757
3.176	SBAS33	760
3.177	SBAS34	762
3.178	SBAS35	764
3.179	SBAS45	766
3.180	SBASALMANAC	768
3.181	SOFTLOADSTATUS	770
3.182	SOURCETABLE	773
3.183	TECTONICSCOMPENSATION	776
3.184	TERRASTARINFO	778
3.185	TERRASTARSTATUS	781
3.186	TIME	783
3.187	TIMESYNC	785
3.188	TRACKSTAT	786
3.189	TRANSFERPORTSTATUS	788
3.190	UPTIME	790
3.191	USERI2CRESPONSE	791
3.192	VALIDMODELS	794
3.193	VERSION	796
3.194	WIFIAPSETTINGS	801
3.195	WIFINETLIST	804
3.196	WIFISTATUS	805

Chapter 4 Agriculture SPAN Commands

4.1	ALIGNMENTMODE	810
4.2	CONNECTIMU	812
4.3	EXTERNALPVAS	814
4.4	INSALIGNCONFIG	819
4.5	INSCALIBRATE	822
4.6	INSCOMMAND	824
4.7	INSSEED	825
4.8	INSTHRESHOLDS	827
4.9	RELINSAUTOMATION	828
4.10	RELINSCONFIG	830
4.11	SETALIGNMENTVEL	832
4.12	SETINITAZIMUTH	833
4.13	SETINSPROFILE	834
4.14	SETINSROTATION	835

4.15	SETINSTRANSULATION	838
4.16	SETINSUPDATE	841
4.17	SETRELINSOUTPUTFRAME	842

Chapter 5 SPAN Logs

5.1	Logs with INS or GNSS Data	845
5.2	BESTGNSSPOS	846
5.3	BESTGNSSVEL	849
5.4	CORRIMUDATA	851
5.5	CORRIMUDATAS	853
5.6	GIMBALLEDPVA	854
5.7	IMURATECORRIMUS	856
5.8	IMURATEPVA	858
5.9	IMURATEPVAS	860
5.10	INSATT	862
5.11	INSATTQS	864
5.12	INSATTS	866
5.13	INSATTX	867
5.14	INSCALSTATUS	871
5.15	INSCONFIG	873
5.16	INSPOS	877
5.17	INSPOSS	878
5.18	INSPOSX	879
5.19	INSPVA	881
5.20	INSPVACMP	883
5.21	INSPVAS	885
5.22	INSPVASDCMP	887
5.23	INSPVAX	889
5.24	INSSEEDSTATUS	892
5.25	INSSPD	894
5.26	INSSPDS	896
5.27	INSSTDEV	898
5.28	INSSTDEVS	900
5.29	INSUPDATESTATUS	902
5.30	INSVEL	906
5.31	INSVELS	907
5.32	INSVELX	908
5.33	RAWIMU	910
5.34	RAWIMUS	929
5.35	RAWIMUSX	933
5.36	RAWIMUX	937
5.37	RELINSPVA	941

5.38 SYNCRELINSPVA	944
5.39 TSS1	947
5.40 VARIABLELEVERARM	949

Chapter 6 Responses

APPENDIX A Example of Bit Parsing a RANGEEMP4 Log

A.1 Reference Log Decoding	960
A.1.1 Reference Header	960
A.1.2 Reference Satellite and Signal Block: GPS	960
A.1.3 Reference Measurement Block Header: GPS	962
A.1.4 Reference Measurement Block: GPS	962
A.1.5 Reference Primary Signal Measurement Block: GPS PRN 10 – L1CA	963
A.1.6 Reference Secondary Signals Measurement Block: GPS PRN 10 – L2Y	965
A.1.7 Reference Third Signals Measurement Block: GPS PRN 10 – L5Q	967
A.1.8 Reference Satellite and Signal Block: GLONASS	969
A.1.9 Reference Measurement Block Header: GLONASS PRN 38	971
A.1.10 Reference Primary Signal Measurement Block: GLONASS PRN 38 – L1CA	972
A.2 Differential Log Decoding	974
A.2.1 Differential Header	974
A.2.2 Differential Satellite and Signal Block	974
A.2.3 Differential Measurement Block Header	976
A.2.4 Differential Measurement Block	976
A.2.5 Differential Primary Signal Measurement Block GPS PRN 10 – L1CA	977
A.2.6 Differential Secondary Signals Measurement Block GPS PRN 10 – L2Y	980
A.2.7 Differential Third Signals Measurement Block GPS PRN 10 – L5Q	981

Figures

Figure 1: Byte Arrangements	28
Figure 2: Illustration of Magnetic Variation and Correction	186
Figure 3: Moving Base Station 'Daisy Chain' Effect	190
Figure 4: Using the SEND Command	275
Figure 5: Illustration of Undulation	317
Figure 6: The WGS84 ECEF Coordinate System	392
Figure 7: Pass Through Log Data	555
Figure 8: Channel Tracking Example	614

Tables

Table 1: Field Type	27
Table 2: ASCII Message Header Structure	30
Table 3: Binary Message Header Structure	31
Table 4: Detailed Port Identifier	33
Table 5: Available Port Types	41
Table 6: Short ASCII Message Header Structure	42
Table 7: Short Binary Message Header Structure	42
Table 8: Binary Message Response Structure	44
Table 9: Binary Message Sequence	45
Table 10: PRN Numbers for Commands and Logs	46
Table 11: GPS Reference Time Status	47
Table 12: Channel State	58
Table 13: Satellite System	60
Table 14: L-Band Assignment Option	62
Table 15: AUTH Command State	64
Table 16: Frequency Type	70
Table 17: Antenna Type	73
Table 18: Radome Type	81
Table 19: Velocity Types	85
Table 20: CAN Port Speed	88
Table 21: CAN Protocol	91
Table 22: Tx, DTR and RTS Availability	97
Table 23: Configuration Actions	99
Table 24: User Dynamics	107
Table 25: Communications Port Identifiers	110
Table 26: FIX Parameters	125
Table 27: Fix Types	126
Table 28: FRESET Target	128
Table 29: Datum Anchors	138
Table 30: Serial Port Interface Modes	151
Table 31: RF Path Selection	160
Table 32: Frequency Bands	163
Table 33: Mode	163

Table 34: Programmable Filter ID	165
Table 35: Programmable Filter Mode	165
Table 36: Data Sources for PSD Samples	167
Table 37: Frequency Types	168
Table 38: FFT Sizes	169
Table 39: NMEA Talkers	197
Table 40: Epoch Options	205
Table 41: PSRDIFFSOURCE Type	225
Table 42: Response Modes	231
Table 43: Network RTK Mode	238
Table 44: RTK Source Type	244
Table 45: Radio Behavior	250
Table 46: Compatibility Mode	251
Table 47: Base Type	251
Table 48: Turn Radio On, Off or Factory Reset	259
Table 49: System Types	266
Table 50: SBAS Time Out Mode	269
Table 51: COM Port Identifiers	278
Table 52: Parity	278
Table 53: Handshaking	278
Table 54: Ports Supporting RS-422	280
Table 55: Selection Type	285
Table 56: Ionospheric Correction Models	286
Table 57: Available Set Up Commands	293
Table 58: STEADYLINE Mode	296
Table 59: TRACKSV Command Condition	309
Table 60: User Accuracy Level Supplemental Position Types and NMEA Equivalentents	312
Table 61: Log Type Triggers	346
Table 62: Position Averaging Status	359
Table 63: Data Source	367
Table 64: Transformation Status	369
Table 65: Solution Status	374
Table 66: Position or Velocity Type	375
Table 67: GPS and GLONASS Signal-Used Mask	377
Table 68: Galileo and BeiDou Signal-Used Mask	378

Table 69: Extended Solution Status	378
Table 70: Supplemental Position Types and NMEA Equivalentents	379
Table 71: Observation Statuses	381
Table 72: BESTSATS GPS Signal Mask	382
Table 73: BESTSATS GLONASS Signal Mask	383
Table 74: BESTSATS Galileo Signal Mask	383
Table 75: BESTSATS BeiDou Signal Mask	383
Table 76: Definitions	392
Table 77: CHANCONFIGLIST Signal Type	396
Table 78: Clock Model Status	400
Table 79: Clock Source	402
Table 80: Steering State	402
Table 81: Signal Type	418
Table 82: Kp UTC Leap Second Descriptions	430
Table 83: GLONASS Ephemeris Flags Coding	434
Table 84: P1 Flag Range Values	434
Table 85: GPS Quality Indicators	445
Table 86: Position Precision of NMEA Logs	448
Table 87: Position Precision of NMEA Logs	450
Table 88: NMEA Positioning System Mode Indicator	450
Table 89: NMEA Positioning System Mode Indicator	461
Table 90: URA Variance	464
Table 91: NMEA Positioning System Mode Indicator	467
Table 92: Solution Source	471
Table 93: Satellite System	477
Table 94: HWMONITOR Status Table	480
Table 95: DDC Filter Type	492
Table 96: ITFILTable Status Word	493
Table 97: Filter Switches	494
Table 98: Spectral Analysis Status Word	498
Table 99: Node Status	501
Table 100: L-Band Signal Tracking Status	505
Table 101: File System Status	512
Table 102: Lua Data Source	513
Table 103: Script Status	514

Table 104: Feature Status	531
Table 105: Feature Type	532
Table 106: GNSS Time Scales	542
Table 107: Oceanix Subscription Type	549
Table 108: Oceanix Subscription Details Mask	549
Table 109: Oceanix Region Restriction	549
Table 110: Decoder Data Synchronization State	550
Table 111: Region Restriction Status	551
Table 112: System Used for Timing	561
Table 113: Position Type	573
Table 114: PPP Seed Application Status	577
Table 115: Status Word	580
Table 116: System Used for Timing	584
Table 117: Emulated Radar Status	607
Table 118: RAIM Mode Types	609
Table 119: Integrity Status	609
Table 120: Protection Level Status	610
Table 121: Channel Tracking Status	614
Table 122: Tracking State	616
Table 123: Correlator Type	616
Table 124: RINEX Mappings	617
Table 125: Range Record Format (RANGECMP only)	620
Table 126: StdDev-PSR Values	622
Table 127: Satellite Block of the Range Record Format (RANGECMP2 only)	624
Table 128: Signal Block of the Range Record Format (RANGECMP2 only)	625
Table 129: Std Dev PSR Scaling	626
Table 130: Std Dev ADR Scaling	627
Table 131: L1/E1/B1 Scaling	628
Table 132: Signal Type (only in RANGECMP2)	629
Table 133: Header	633
Table 134: Satellite and Signal Block	633
Table 135: Measurement Block Header	634
Table 136: Primary Reference Signal Measurement Block	635
Table 137: Secondary Reference Signals Measurement Block	636
Table 138: Primary Differential Signal Measurement Block	637

Table 139: Secondary Differential Signals Measurement Block	639
Table 140: Signal Bit Mask	640
Table 141: Lock Time	641
Table 142: ADR Std Dev	641
Table 143: Pseudorange Std Dev	642
Table 144: Base Station Status	658
Table 145: Station Type	658
Table 146: Legacy Observable Messages	663
Table 147: MSM Type Descriptions	664
Table 148: MSM Log Names	665
Table 149: MSM Message IDs	665
Table 150: Station and Antenna Messages	666
Table 151: Ephemeris Messages	666
Table 152: System Used for Timing	673
Table 153: Receiver Error	688
Table 154: Receiver Status	690
Table 155: Version Bits	692
Table 156: Auxiliary 1 Status	692
Table 157: Auxiliary 2 Status	694
Table 158: Auxiliary 3 Status	695
Table 159: Antenna Gain State	696
Table 160: Auxiliary 4 Status	697
Table 161: Status Word	700
Table 162: Event Type	701
Table 163: Safe Mode States	703
Table 164: Compatibility Mode	706
Table 165: ASCII and Binary Values	709
Table 166: Radio State	711
Table 167: Error Types	711
Table 168: Evaluation of UDREI	724
Table 169: Evaluation of UDREI	758
Table 170: SBAS Subsystem Types	769
Table 171: SoftLoad Status Type	770
Table 172: Tectonics Compensation Status	776
Table 173: TerraStar Subscription Type	779

Table 174: TerraStar Subscription Details Mask	779
Table 175: TerraStar Region Restriction	780
Table 176: Decoder Data Synchronization State	781
Table 177: TerraStar Local Area Status	782
Table 178: TerraStar Geogating Status	782
Table 179: USB Detection Type	788
Table 180: USB Mode	789
Table 181: Error Code	792
Table 182: Operation Mode Code	793
Table 183: Component Types	798
Table 184: Firmware and Boot Version Field Formats	799
Table 185: Wi-Fi Band	802
Table 186: Wi-Fi Security Protocol	802
Table 187: Wi-Fi Encryption Type	802
Table 188: Regulatory Region	803
Table 189: Wi-Fi Security Type	804
Table 190: Wi-Fi Status	806
Table 191: IMU Type	813
Table 192: EXTERNALPVAS Updates Mask	817
Table 193: EXTERNALPVAS Options Mask	818
Table 194: COM Ports	831
Table 195: Rotational Offset Types	836
Table 196: Translation Offset Types	839
Table 197: Translation Input Frame	840
Table 198: Inertial Solution Status	863
Table 199: Extended Solution Status	868
Table 200: Alignment Indication	870
Table 201: NVM Seed Indication	870
Table 202: Offset Type	872
Table 203: Source Status	872
Table 204: Injection Status	893
Table 205: Validity Status	893
Table 206: DMI Update Status	903
Table 207: Heading Update Values	903
Table 208: INS Update Values	904

Table 209: iIMU-FSAS IMU Status	912
Table 210: HG1700 IMU Status	913
Table 211: LN200 IMU Status	915
Table 212: ISA-100C IMU Status	916
Table 213: IMU-CPT IMU Status	917
Table 214: IMU-KVH1750 IMU Status	919
Table 215: HG1900 and HG1930 IMU Status	920
Table 216: HG4930 IMU Status	922
Table 217: ADIS16488 and IMU-IGM-A1 IMU Status	923
Table 218: STIM300 and IMU-IGM-S1 IMU Status	924
Table 219: μ IMU IMU Status	926
Table 220: G320N and G370N IMU Status	927
Table 221: Raw IMU Scale Factors	931
Table 222: Response Messages	950

Customer Support

NovAtel Knowledge Base

If you have a technical issue, visit the NovAtel Support page at www.novatel.com/support. Through the *Support* page, you can contact Customer Support, find papers and tutorials or download current manuals and the latest firmware.

Before Contacting Customer Support

Before contacting NovAtel Customer Support about a software problem, perform the following steps:



If logging data over an RS-232 serial cable, ensure that the configured baud rate can support the data bandwidth (see **SERIALCONFIG** command). NovAtel recommends a minimum suggested baud rate of 230400 bps.

1. Log the following data to a file on your computer for 15 minutes:

```
LOG RXSTATUSB onchanged
LOG ALMANACB onchanged
LOG RAWEPHEMB onchanged
LOG GLORAWEPHEMB onchanged
LOG TRACKSTATB ontime 1
LOG SATVIS2B ontime 60
LOG BESTPOSB ontime 1
LOG RANGE B ontime 1
LOG RXCONFIGA once
LOG ITDETECTSTATUSB onchanged
LOG VERSIONA once
LOG PORTSTATSB ontime 10
```

For SPAN systems, add the following logs to the above list in the file created on your computer:

```
LOG RAWIMUSXB onnew
LOG INSUPDATESTATUSB onnew
LOG INSPVAXB ontime 1
LOG INSCONFIGA onchanged
```

For issues with tracking L-Band or TerraStar (PPP) convergence, add the following logs to the above list in the file created on your computer:

```
LOG IONUTCB onchanged
LOG GLOCLKB onchanged
LOG PPPPOSB ontime 1
LOG PPPSATSB ontime 1
LOG LBANDTRACKSTATB ontime 1
LOG TERRASTARINFOA onchanged
LOG TERRASTARSTATUSA onchanged
LOG LBANDBEAMTABLEA onchanged
```

2. Send the data file to NovAtel Customer Support: support@novatel.com
3. You can also issue a **FRESET** command to the receiver to clear any unknown settings.



The **FRESET** command will erase all user settings. You should know your configuration (by requesting the RXCONFIGA log) and be able to reconfigure the receiver before you send the **FRESET** command.

If you are having a hardware problem, send a list of the troubleshooting steps taken and the results.

Contact Information

Log a support request with NovAtel Customer Support using one of the following methods:

Log a Case and Search Knowledge:

Website: www.novatel.com/support

Log a Case, Search Knowledge and View Your Case History: (login access required)

Web Portal: <https://novatelsupport.force.com/community/login>

E-mail:

support@novatel.com

Telephone:

U.S. and Canada: 1-800-NOVATEL (1-800-668-2835)

International: +1-403-295-4900

Foreword

This manual describes each command and log the OEM7 receivers and SMART2 receiver are capable of accepting or generating. Sufficient detail is provided so you can understand the purpose, syntax and structure of each command or log. You will also be able to communicate with the receiver, enabling you to effectively use and write custom interfacing software for specific applications.

Related Documents and Information

OEM7 and SMART2 products include the following:

- Support for all current and upcoming GNSS constellations
- Real-Time Kinematic (RTK) available on OEM7 receivers only
- L-Band capability including TerraStar licensed based corrections
- Satellite Based Augmentation System (SBAS) signal functionality
- Differential Global Positioning System (DGPS)
- National Marine Electronics Association (NMEA) standards, a protocol used by GNSS receivers to transmit data

For more information on these components, refer the Support page on our website at www.novatel.com/support. For introductory information on GNSS technology, refer to our *An Introduction to GNSS* book found at www.novatel.com/an-introduction-to-gnss/.

This manual does not address any of the receiver hardware attributes or installation information. Consult the product specific Installation and Operation User Manuals for information about these topics (docs.novatel.com/OEM7). Furthermore, should you encounter any functional, operational or interfacing difficulties with the receiver, refer to the NovAtel web site for warranty and support information.

Prerequisites

As this reference manual is focused on the OEM7 family commands and logging protocol, it is necessary to ensure the receiver has been properly installed and powered up according to the instructions outlined in the companion product specific user manuals (docs.novatel.com/OEM7).

Logs and Commands Defaults and Structure

- The factory defaults for commands and logs are shown after the syntax but before the example in the command or log description.
- The letter H in the Binary Byte or Binary Offset columns of the commands and logs tables represents the header length for that command or log, see *Binary* on page 31.
- The number following 0x is a hexadecimal number.
- Default values shown in command tables indicate the assumed values when optional parameters have been omitted. Default values do not imply the factory default settings.
- Parameters surrounded by [and] are optional in a command or are required for only some instances of the command depending on the values of other parameters.

- Text displayed between < and > indicates the entry of a keystroke in the case of the command or an automatic entry in the case of carriage return <CR> and line feed <LF> in data output.
- In tables where no values are given they are assumed to be reserved for future use.
- Status words in ASCII logs are output as hexadecimal numbers and must be converted to binary format (and in some cases then also to decimal) to parse the fields because they are not fixed in 4-bits boundary. For an example of this type of conversion, see the RANGE log, *Table 121: Channel Tracking Status* on page 614.
- Conversions and their binary or decimal results are always read from right to left. For a complete list of hexadecimal, binary and decimal equivalents, refer to the [Unit Conversion](#) information available on our website at www.novatel.com/support/search/.
- ASCII log examples may be split over several lines for readability. In reality, only a single [CR][LF] pair is transmitted at the end of an ASCII log.

You can download the most up-to-date version of this manual from the OEM7 Documentation Portal (docs.novatel.com/OEM7).

Chapter 1 Messages

The receiver handles incoming and outgoing NovAtel data in three different message formats: Abbreviated ASCII, ASCII and Binary. This allows for a great deal of versatility in the way the OEM7 and SMART2 receivers can be used. All NovAtel commands and logs can be entered, transmitted, output or received in any of the three formats. The receiver also supports RTCMV3, NOVATELX and NMEA format messaging.

When entering an ASCII or abbreviated ASCII command to request an output log, the message type is indicated by the character appended to the end of the message name. 'A' indicates the message is ASCII and 'B' indicates binary. No character means the message is Abbreviated ASCII. When issuing binary commands, the output message type is dependent on the bit format in the message's binary header (refer to *Binary* on page 31).

Table 1: Field Type below below, describes the field types used in the description of messages.

Table 1: Field Type

Type	Binary Size (bytes)	Description
Char	1	The char type is an 8-bit integer in the range -128 to +127. As a binary value, a two's compliment format is used. This integer value may be the ASCII code corresponding to the specified character. In ASCII or Abbreviated ASCII this comes out as an actual character.
UChar	1	The uchar type is an 8-bit unsigned integer. Values are in the range from +0 to +255. In ASCII or Abbreviated ASCII this comes out as a number.
Short	2	The short type is 16-bit integer in the range -32768 to +32767. As a binary value, a two's compliment format is used.
UShort	2	The same as short except it is not signed. Values are in the range from +0 to +65535.
Long	4	The long type is 32-bit integer in the range -2147483648 to +2147483647. As a binary value, a two's compliment format is used.
ULong	4	The same as long except it is not signed. Values are in the range from +0 to +4294967295.
Double	8	The double type contains 64-bits: 1 for sign, 11 for the exponent and 52 for the mantissa. Its range is $\pm 1.7E308$ with at least 15 digits of precision. This is IEEE 754.
Float	4	The float type contains 32-bits: 1 for the sign, 8 for the exponent and 23 for the mantissa. Its range is $\pm 3.4E38$ with at least 7 digits of precision. This is IEEE 754.
Enum	4	A 4-byte enumerated type beginning at zero (an unsigned long). In binary, the enumerated value is output. In ASCII or Abbreviated ASCII, the enumeration label is spelled out.

Type	Binary Size (bytes)	Description
GPSec	4	This type has two separate formats dependent on whether you requested a binary or an ASCII format output. For binary, the output is in milliseconds and is a long type. For ASCII, the output is in seconds and is a float type.
Hex	n	Hex is a packed, fixed length (n) array of bytes in binary but in ASCII or Abbreviated ASCII is converted into 2 character hexadecimal pairs.
Hex Ulong	4	An unsigned, 32-bit integer in hexadecimal format. Values are in the range from +0 to +4294967295.
String	n	String is a variable length array of bytes that is null-terminated in the binary case and additional bytes of padding are added to maintain 4-byte alignment. The maximum byte length for each String field is shown in the row in the log or command tables.

Figure 1: Byte Arrangements

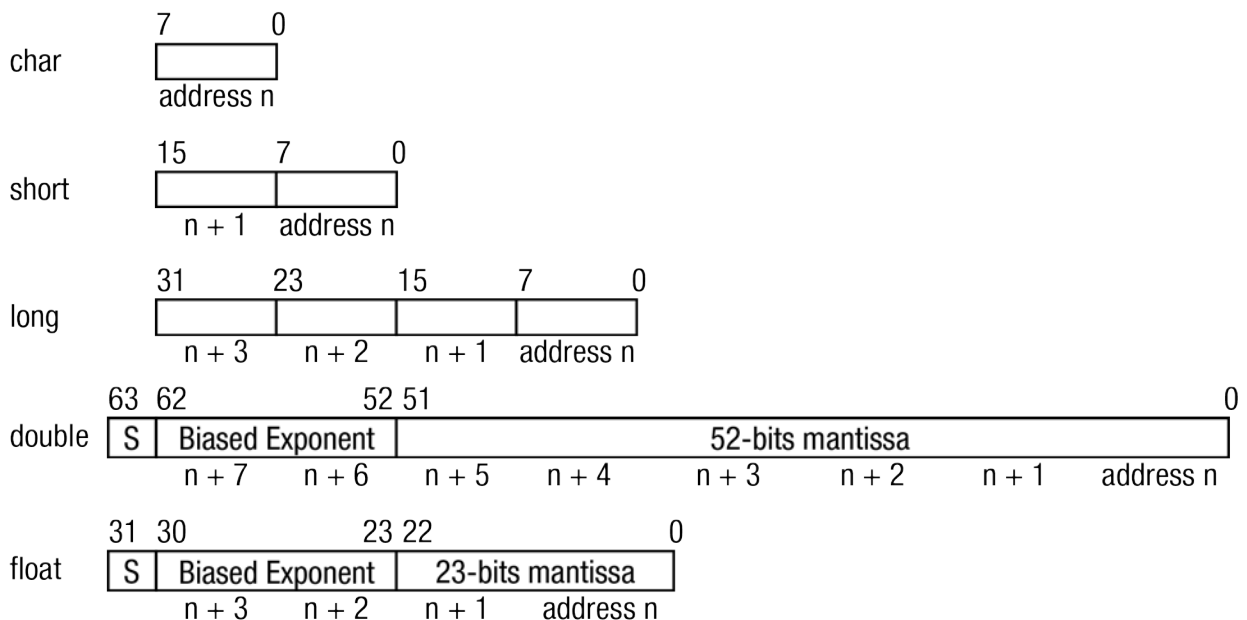

Byte Arrangements above shows the arrangement of bytes, within each field type, when used by IBM PC computers. All data sent to or from the OEM7 and SMART2 receivers is ordered least significant bit (LSB) first (little-endian). This is opposite to the most significant bit first (big-endian) ordering that is shown in *Byte Arrangements* above. Data is then stored in the receiver LSB first. For example, in char type data, the LSB is bit 0 and the most significant bit (MSB) is bit 7. See *Table 121: Channel Tracking Status* on page 614 for a more detailed example.

1.1 ASCII

ASCII messages are readable by both the user and a computer. The structures of all ASCII messages follow the general conventions as noted here:

1. The lead code identifier for each record is '#'.
2. Each log or command is of variable length depending on amount of data and formats.
3. All data fields are delimited by a comma ',' with two exceptions:
 - The first exception is the last header field which is followed by a ';' to denote the start of the data message.
 - The second exception is the last data field, which is followed by a * to indicate end of message data.
4. Each log ends with a hexadecimal number preceded by an asterisk and followed by a line termination using the carriage return and line feed characters.

For example:

*1234ABCD[CR][LF]. This value is a 32-bit CRC of all bytes in the log, excluding the '#' identifier and the asterisk preceding the eight CRC digits.

See *32-Bit CRC* on page 48 for the algorithm used to generate the CRC.

5. The receiver only accepts the following ASCII characters.
 - characters between space (ASCII value 32) and '~' (ASCII value 126) inclusive,
 - vertical tab (ASCII value 9)
 - line feed (ASCII value 10)
 - horizontal tab (ASCII value 11)
 - carriage return (ASCII value 13)

Other values are discarded and can lead to unexpected results.

6. An ASCII string is one field and is surrounded by double quotation marks.

For example:

"ASCII string". If separators are surrounded by quotation marks then the string is still one field and the separator will be ignored (example, "xxx,xxx" is one field). Double quotation marks within a string are not allowed.

7. If the receiver detects an error parsing an input message, it returns an error response message. See *Responses* on page 950 for a list of response messages from the receiver.

Message Structure:

header; data field..., data field..., data field... *xxxxxxx [CR][LF]

The ASCII message header structure is described in *Table 2: ASCII Message Header Structure* on the next page.

Table 2: ASCII Message Header Structure

Field	Field Name	Field Type	Description	Ignored on Input
1	Sync	Char	Sync character. The ASCII message is always preceded by a single '#' symbol	N
2	Message	Char	The ASCII name of the log or command	N
3	Port	Char	The name of the port from which the log was generated. The string is made up of the port name followed by an _x where x is a number from 1 to 31 denoting the virtual address of the port. If no virtual address is indicated, it is assumed to be address 0	Y
4	Sequence #	Long	Used for multiple related logs. It is a number that counts down from N-1 to 0, where 0 means it is the last one of the set. Most logs only come out one at a time in which case this number is 0	N
5	% Idle Time	Float	The minimum percentage of time the processor is idle, calculated once per second	Y
6	Time Status	Enum	The value indicates the quality of the GPS reference time (see <i>Table 11: GPS Reference Time Status</i> on page 47)	Y
7	Week	Ulong	GPS reference week number	Y
8	Seconds	GPSec	Seconds from the beginning of the GPS reference week; accurate to the millisecond level	Y
9	Receiver Status	Ulong	An eight digit hexadecimal number representing the status of various hardware and software components of the receiver (see <i>Table 154: Receiver Status</i> on page 690)	Y
10	Reserved	Ulong	Reserved for internal use	Y
11	Receiver S/W Version	Ulong	A value (0 - 65535) representing the receiver software build number	Y
12	;	Char	The character indicates the end of the header	N

Example Log:

```
#RAWEPHEMA, COM1, 0, 55.5, SATTIME, 2072, 133140.000, 02000000, 58ba, 15761; 32, 2072,
136800, 8b00602b57a606100004389101eefa4e0eed24e012f216600007608cd27,
8b00602b58282f02373454d33b986d01bd01a76ba710a2a10d008e21667f,
8b00602b58ae003384abe701001226ff6c6c1c9999f3c99fffa77c2f05c8*d3806ea3
```

1.2 Abbreviated ASCII

This message format is designed to make entering and viewing commands and logs simple. The data is represented as simple ASCII characters, separated by spaces or commas and arranged

in an easy to understand format. There is no 32-bit CRC for error detection because it is meant for viewing by the user.

Example Command:

```
log com1 loglist
```

Resultant Log:

```
<LOGLIST COM1 0 69.0 FINE 0 0.000 00240000 206d 0
< 4
< COM1 RXSTATUSEVENTA ONNEW 0.000000 0.000000 NOHOLD
< COM2 RXSTATUSEVENTA ONNEW 0.000000 0.000000 NOHOLD
< COM3 RXSTATUSEVENTA ONNEW 0.000000 0.000000 NOHOLD
< COM1 LOGLIST ONCE 0.000000 0.000000 NOHOLD
```

The array of 4 entries are offset from the left hand side and start with '<'.

1.3 Binary

Binary messages are strictly machine readable format. They are ideal for applications where the amount of data transmitted is fairly high. Due to the inherent compactness of binary as opposed to ASCII data, messages are much smaller. The smaller message size allows a larger amount of data to be transmitted and received by the receiver's communication ports. The structure of all binary messages follows the general conventions as noted here:

1. Basic format of:
 - *Header*: 3 Sync bytes plus 25-bytes of header information. The header length is variable as fields may be appended in the future. Always check the header length.
 - *CRC*: 4 bytes
 - *Data*: variable
2. The 3 Sync bytes will always be:

Byte	Hex	Decimal
First	AA	170
Second	44	68
Third	12	18

3. The CRC is a 32-bit CRC (see *32-Bit CRC* on page 48 for the CRC algorithm) performed on all data including the header.
4. The header is in the format shown in *Table 3: Binary Message Header Structure* below.

Table 3: Binary Message Header Structure

Field	Field Name	Field Type	Description	Binary Bytes	Binary Offset	Ignored on Input
1	Sync	Uchar	Hexadecimal 0xAA	1	0	N

Field	Field Name	Field Type	Description	Binary Bytes	Binary Offset	Ignored on Input
2	Sync	Uchar	Hexadecimal 0x44	1	1	N
3	Sync	Uchar	Hexadecimal 0x12	1	2	N
4	Header Length	Uchar	Length of the header	1	3	N
5	Message ID	Ushort	This is the Message ID number of the log (see the command or log descriptions for the Message ID values of individual commands or logs)	2	4	N
6	Message Type	Char	Bits 0-4 = Measurement source ¹ Bits 5-6 = Format 00 = Binary 01 = ASCII 10 = Abbreviated ASCII, NMEA 11 = Reserved Bit 7 = Response bit (see <i>Message Responses</i> on page 42) 0 = Original Message 1 = Response Message	1	6	N
7	Port Address	Uchar	See <i>Table 4: Detailed Port Identifier</i> on the next page (decimal values ≥ 32 may be used) (lower 8-bits only) ²	1	7	N ³
8	Message Length	Ushort	The length in bytes of the body of the message, not including the header nor the CRC	2	8	N
9	Sequence	Ushort	Used for multiple related logs. It is a number that counts down from N-1 to 0 where N is the number of related logs and 0 means it is the last one of the set. Most logs only come out one at a time in which case this number is 0	2	10	N

¹Bits 0-4 are used to indicate the measurement source. For dual antenna receivers, if bit 0 is set, the log is from the secondary antenna.

²The 8-bit size means you will only see 0xA0 to 0xBF when the top bits are dropped from a port value greater than 8-bits. For example, ASCII port USB1 will be seen as 0xA0 in the binary output.

³Recommended value is THISPORT (decimal 192).

Field	Field Name	Field Type	Description	Binary Bytes	Binary Offset	Ignored on Input
10	Idle Time	Uchar	Time the processor is idle, calculated once per second. This value is a percentage, ranging from 0 to 100. 0% indicates the processor is fully occupied. Other values indicate the availability of the processor to take on tasks.	1	12	Y
11	Time Status	Enum	Indicates the quality of the GPS reference time (see <i>Table 11: GPS Reference Time Status</i> on page 47).	1 ¹	13	N ²
12	Week	Ushort	GPS reference week number	2	14	N
13	ms	GPSec	Milliseconds from the beginning of the GPS reference week	4	16	N
14	Receiver Status	Ulong	32-bits representing the status of various hardware and software components of the receiver (see <i>Table 154: Receiver Status</i> on page 690)	4	20	Y
15	Reserved	Ushort	Reserved for internal use	2	24	Y
16	Receiver S/W Version	Ushort	A value (0 - 65535) representing the receiver software build number	2	26	Y

Table 4: Detailed Port Identifier

ASCII Port Name	Hex Port Value	Decimal Port Value	Description
NO_PORTS	0	0	No ports specified
COM1_ALL	1	1	All virtual ports for COM1
COM2_ALL	2	2	All virtual ports for COM2
COM3_ALL	3	3	All virtual ports for COM3
THISPORT_ALL	6	6	All virtual ports for the current port
FILE_ALL	7	7	All virtual ports for logging to file

¹This ENUM is not 4-bytes long but, as indicated in the table, is only 1-byte.

²Fields 12 and 13 (Week and ms) are ignored if Field 11 (Time Status) is invalid. In this case, the current receiver time is used. The recommended values for the three time fields are 0, 0, 0.

ASCII Port Name	Hex Port Value	Decimal Port Value	Description
ALL_PORTS	8	8	All virtual ports for all ports
USB1_ALL	d	13	All virtual ports for USB1
USB2_ALL	e	14	All virtual ports for USB2
USB3_ALL	f	15	All virtual ports for USB3
AUX_ALL	10	16	All virtual ports for the AUX
COM4_ALL	13	19	All virtual ports for COM4
ETH1_ALL	14	20	All virtual ports for ETH1
IMU_ALL	15	21	All virtual ports for IMU
ICOM1_ALL	17	23	All virtual ports for ICOM1
ICOM2_ALL	18	24	All virtual ports for ICOM2
ICOM3_ALL	19	25	All virtual ports for ICOM3
NCOM1_ALL	1a	26	All virtual ports for NCOM1
NCOM2_ALL	1b	27	All virtual ports for NCOM2
NCOM3_ALL	1c	28	All virtual ports for NCOM3
ICOM4_ALL	1d	29	All virtual ports for ICOM4
WCOM1_ALL	1e	30	All virtual ports for WCOM1
COM1	20	32	COM1, virtual port 0
COM1_1	21	33	COM1, virtual port 1
...			
COM1_31	3f	63	COM1, virtual port 31
COM2	40	64	COM2, virtual port 0
COM2_1	41	65	COM1, virtual port 1
...			
COM2_31	5f	95	COM2, virtual port 31
COM3	60	96	COM3, virtual port 0
COM3_1	61	97	COM3, virtual port 1
...			
COM3_31	7f	127	COM3, virtual port 31

ASCII Port Name	Hex Port Value	Decimal Port Value	Description
SPECIAL	a0	160	Unknown port, virtual port 0
SPECIAL_1	a1	161	Unknown port, virtual port1
...			
SPECIAL_31	bf	191	Unknown port, virtual port 31
THISPORT	c0	192	Current COM port, virtual port 0
THISPORT_1	c1	193	Current COM port, virtual port 1
...			
THISPORT_31	df	223	Current COM port, virtual port 31
FILE	e0	224	Virtual port 0 for logging to file
FILE_1	e1	225	Virtual port 1 for logging to file
...			
FILE_31	ff	255	Virtual port 31 for logging to file
USB1	5a0	1440	USB1, virtual port 0
USB1_1	5a1	1441	USB1, virtual port 1
...			
USB1_31	5bf	1471	USB1, virtual port 31
USB2	6a0	1696	USB2, virtual port 0
USB2_1	6a1	1967	USB2, virtual port 1
...			
USB2_31	6bf	1727	USB2, virtual port 31
USB3	7a0	1952	USB3, virtual port 0
USB3_1	7a1	1953	USB3, virtual port 1
...			
USB3_31	7bf	1983	USB port 3, virtual port 31
AUX	8a0	2208	AUX port, virtual port 0
AUX_1	8a1	2209	AUX port, virtual port 1
...			
AUX_31	8bf	2239	AUX port, virtual port 31

ASCII Port Name	Hex Port Value	Decimal Port Value	Description
COM4	ba0	2976	COM4, virtual port 0
COM4_1	ba1	2977	COM4, virtual port 1
...			
COM4_31	bbf	3007	COM4, virtual port 31
ETH1	ca0	3232	ETH1, virtual port 0
ETH1_1	ca1	3233	ETH1, virtual port 1
...			
ETH1_31	cbf	3263	ETH1, virtual port 31
IMU	da0	3488	IMU, virtual port 0
IMU_1	da1	3489	IMU, virtual port 1
...			
IMU_31	dbf	3519	IMU, virtual port 31
ICOM1	fa0	4000	ICOM1, virtual port 0
ICOM1_1	fa1	4001	ICOM1, virtual port 1
...			
ICOM1_31	fbf	4031	ICOM1, virtual port 31
ICOM2	10a0	4256	ICOM2, virtual port 0
ICOM2_1	10a1	4257	ICOM2, virtual port 1
...			
ICOM2_31	10bf	4287	ICOM2, virtual port 31
ICOM3	11a0	4512	ICOM3, virtual port 0
ICOM3_1	11a1	4513	ICOM3, virtual port 1
...			
ICOM3_31	11bf	4543	ICOM3, virtual port 31
NCOM1	12a0	4768	NCOM1, virtual port 0
NCOM1_1	12a1	4769	NCOM1, virtual port 1
...			
NCOM1_31	12bf	4799	NCOM1, virtual port 31

ASCII Port Name	Hex Port Value	Decimal Port Value	Description
NCOM2	13a0	5024	NCOM2, virtual port 0
NCOM2_1	13a1	5025	NCOM2, virtual port 1
...			
NCOM2_31	13bf	5055	NCOM2, virtual port 31
NCOM3	14a0	5280	NCOM3, virtual port 0
NCOM3_1	14a1	5281	NCOM3, virtual port 1
...			
NCOM3_31	14bf	5311	NCOM3, virtual port 31
ICOM4	15a0	5536	ICOM4, virtual port 0
ICOM4_1	15a1	5537	ICOM4, virtual port 1
...			
ICOM4_31	15bf	5567	ICOM4, virtual port 31
WCOM1	16a0	5792	WCOM1, virtual port 0
WCOM1_1	16a1	5793	WCOM1, virtual port 1
...			
WCOM1_31	16bf	5823	WCOM1, virtual port 31
COM5_ALL	16c0	5824	All virtual ports for COM5
COM6_ALL	16c1	5825	All virtual ports for COM6
BT1_ALL	16c2	5826	All virtual ports for the Bluetooth device
COM7_ALL	16c3	5827	All virtual ports for COM7
COM8_ALL	16c4	5828	All virtual ports for COM8
COM9_ALL	16c5	5829	All virtual ports for COM9
COM10_ALL	16c6	5830	All virtual ports for COM10
CCOM1_ALL	16c7	5831	All virtual ports for CCOM1
CCOM2_ALL	16c8	5832	All virtual ports for CCOM2
CCOM3_ALL	16c9	5833	All virtual ports for CCOM3
CCOM4_ALL	16ca	5834	All virtual ports for CCOM4

ASCII Port Name	Hex Port Value	Decimal Port Value	Description
CCOM5_ALL	16cb	5835	All virtual ports for CCOM5
CCOM6_ALL	16cc	5836	All virtual ports for CCOM6
ICOM5_ALL	16cf	5839	All virtual ports for ICOM5
ICOM6_ALL	16d0	5840	All virtual ports for ICOM6
ICOM7_ALL	16d1	5841	All virtual ports for ICOM7
SCOM1_ALL	16d2	5842	All virtual ports for SCOM1
SCOM2_ALL	16d3	5843	All virtual ports for SCOM2
SCOM3_ALL	16d4	5844	All virtual ports for SCOM3
SCOM4_ALL	16d5	5845	All virtual ports for SCOM4
COM5	17a0	6048	COM5, virtual port 0
COM5_1	17a1	6049	COM5, virtual port 1
...			
COM5_31	17bf	6079	COM5, virtual port 31
COM6	18a0	6304	COM6, virtual port 0
COM6_1	18a1	6305	COM6, virtual port 1
...			
COM6_31	18bf	6335	COM6, virtual port 31
BT1	19a0	6560	Bluetooth device, virtual port 0
BT1_1	19a1	6561	Bluetooth device, virtual port 1
...			
BT1_31	19bf	6591	Bluetooth device, virtual port 31
COM7	1aa0	6816	COM7, virtual port 0
COM7_1	1aa1	6817	COM7, virtual port 1
...			
COM7_31	1abf	6847	COM7, virtual port 31
COM8	1ba0	7072	COM8, virtual port 0
COM8_1	1ba1	7073	COM8, virtual port 1
...			

ASCII Port Name	Hex Port Value	Decimal Port Value	Description
COM8_31	1bbf	7103	COM8, virtual port 31
COM9	1ca0	7328	COM9, virtual port 0
COM9_1	1ca1	7329	COM9, virtual port 1
...			
COM9_31	1cbf	7359	COM9, virtual port 31
COM10	1da0	7584	COM10, virtual port 0
COM10_1	1da1	7585	COM10, virtual port 1
...			
COM10_31	1dbf	7615	COM10, virtual port 31
CCOM1	1ea0	7840	CAN COM1, virtual port 0
CCOM1_1	1ea1	7841	CAN COM1, virtual port 1
...			
CCOM1_31	1ebf	7871	CAN COM1, virtual port 31
CCOM2	1fa0	8096	CAN COM2, virtual port 0
CCOM2_1	1fa1	8097	CAN COM2, virtual port 1
...			
CCOM2_31	1fbf	8127	CAN COM2, virtual port 31
CCOM3	20a0	8352	CAN COM3, virtual port 0
CCOM3_1	20a1	8353	CAN COM3, virtual port 1
...			
CCOM3_31	20bf	8383	CAN COM3, virtual port 31
CCOM4	21a0	8608	CAN COM4, virtual port 0
CCOM4_1	21a1	8609	CAN COM4, virtual port 1
...			
CCOM4_31	21bf	8639	CAN COM4, virtual port 31
CCOM5	22a0	8864	CAN COM5, virtual port 0
CCOM5_1	22a1	8865	CAN COM5, virtual port 1
...			

ASCII Port Name	Hex Port Value	Decimal Port Value	Description
CCOM5_31	22bf	8895	CAN COM5, virtual port 31
CCOM6	23a0	9120	CAN COM6, virtual port 0
CCOM6_1	23a1	9121	CAN COM6, virtual port 1
...			
CCOM6_31	23bf	9151	CAN COM6, virtual port 31
ICOM5	26a0	9888	ICOM5, virtual port 0
ICOM5_1	26a1	9889	ICOM5, virtual port 1
...			
ICOM5_31	26bf	9919	ICOM5, virtual port 31
ICOM6	27a0	10144	ICOM6, virtual port 0
ICOM6_1	27a1	10145	ICOM6, virtual port 1
...			
ICOM6_31	27bf	10175	ICOM6, virtual port 31
ICOM7	28a0	10400	ICOM7, virtual port 0
ICOM7_1	28a1	10401	ICOM7, virtual port 1
...			
ICOM7_31	28bf	10431	ICOM7, virtual port 31
SCOM1	29a0	10656	SCOM1, virtual port 0
SCOM1_1	29a1	10657	SCOM1, virtual port 1
...			
SCOM1-31	29bf	10687	SCOM1, virtual port 31
SCOM2	2aa0	10912	SCOM2, virtual port 0
SCOM2_1	2aa1	10913	SCOM2, virtual port 1
...			
SCOM2_31	2abf	10943	SCOM2, virtual port 31
SCOM3	2ba0	11168	SCOM3, virtual port 0
SCOM3_1	2ba1	11169	SCOM3, virtual port 1
...			

ASCII Port Name	Hex Port Value	Decimal Port Value	Description
SCOM3_31	2bbf	11199	SCOM3, virtual port 31
SCOM4	2ca0	11424	SCOM4, virtual port 0
SCOM4_1	2ca1	11425	SCOM4, virtual port 1
...			
SCOM4_31	2cbf	11455	SCOM4, virtual port 31



COM1_ALL, COM2_ALL, COM3_ALL, COM4_ALL, COM5_ALL, THISPORT_ALL, FILE_ALL, ALL_PORTS, USB1_ALL, USB2_ALL, USB3_ALL, AUX_ALL, ETH1_ALL, ICOM1_ALL, ICOM2_ALL, ICOM3_ALL, ICOM4_ALL, ICOM5_ALL, ICOM6_ALL, ICOM7_ALL, CCOM1_ALL, CCOM2_ALL, CCOM3_ALL, CCOM4_ALL, CCOM5_ALL, CCOM6_ALL, NCOM1_ALL, NCOM2_ALL, NCOM3_ALL, SCOM1_ALL, SCOM2_ALL, SCOM3_ALL, SCOM4_ALL and WCOM1_ALL are only valid for the **UNLOGALL** command.



The ports available vary based on the receiver.

Table 5: Available Port Types below provides examples of where each port type might be used.

Table 5: Available Port Types

Port Type	Description	Example of where it might be used
AUX	Auxiliary "serial" ports	An additional UART serial port available only on certain platforms
BTx	Bluetooth ports	These ports are used to connect over Bluetooth devices, when the receiver is equipped with a BT device
COMx	Serial Port	UART serial ports. Used when there is a physical RS-232 or RS-422 connection to the receiver
ICOMx	Internet ports	These ports are used when establishing TCP or UDP connections to the receiver over a network
NCOMx	NTRIP ports	These ports are used when establishing NTRIP connections to the receiver over a network
SCOMx	Script ports	Ports used by the Scripted User Interface (i.e. Lua)
USBx	USB "serial" ports	When the receiver is connected to an external host through USB, these ports are available
WCOMx	Web Server port	Ports used by Web Server applications, for receivers equipped with a web server

1.4 Description of ASCII and Binary Logs with Short Headers

One difference from the standard OEM7 logs is there are two possible headers for the ASCII and binary versions of the INS logs. Which header is used for a given log is described in the log definitions in the *SPAN Logs* on page 844 chapter. The reason for the alternate short headers is that the normal OEM7 binary header is quite long at 28 bytes. This is nearly as long as the data portion of many of the INS logs and creates excess storage and baud rate requirements.

These logs are set up in the same way as normal ASCII or binary logs except a normal ASCII or binary header is replaced with a short header (see *Table 6: Short ASCII Message Header Structure* below and *Table 7: Short Binary Message Header Structure* below).

Table 6: Short ASCII Message Header Structure

Field	Field Name	Field Type	Description
1	%	Char	% symbol
2	Message	Char	This is the name of the log
3	Week Number	Ushort	GNSS week number
4	Seconds	GPSec	Seconds from the beginning of the GNSS week (Same byte arrangement as a Float type)

Table 7: Short Binary Message Header Structure

Field	Field Name	Field Type	Description	Binary Bytes	Binary Offset
1	Synch	Char	Hex 0xAA	1	0
2	Synch	Char	Hex 0x44	1	1
3	Synch	Char	Hex 0x13	1	2
4	Message Length	Uchar	Message length, not including header or CRC	1	3
5	Message ID	Ushort	Message ID number	2	4
6	Week Number	Ushort	GNSS week number	2	6
7	Milliseconds	GPSec	Milliseconds from the beginning of the GNSS week (Same byte arrangement as a Long type)	4	8

1.5 Message Responses

By default, if you input a message you get back a response. If desired, the **INTERFACEMODE** command (see page 148) can be used to disable response messages. The response will be in the exact format you entered the message (that is, binary input = binary response).

1.5.1 Abbreviated ASCII Response

The response is just the leading '<' followed by the response string, for example: <OK.

1.5.2 ASCII Response

The response is the full header with the message name being identical except ending in an 'R' (for response). The body of the message consists of a 40 character string for the response string. For example:

```
#BESTPOSR,COM1,0,67.0,FINE,1028,422060.400,02000000,a31b,0;"OK" *b867caad
```

1.5.3 Binary Response

The response is similar to an ASCII response except that it follows the binary protocols, see *Table 8: Binary Message Response Structure* on the next page.

Table 9: Binary Message Sequence on page 45 is an example of the sequence for requesting and then receiving BESTPOSB. The example is in hex format. When you enter a hex command, you may need to add a '\x' or '0x' before each hex pair, depending on your code. For example:

0xAA0x440x120x1C0x010x000x02 and so on.

Table 8: Binary Message Response Structure

	Field	Field Name	Field Type	Description	Binary Bytes	Binary Offset
B I N A R Y H E A D E R	1	Sync	Char	Hexadecimal 0xAA	1	0
	2	Sync	Char	Hexadecimal 0x44	1	1
	3	Sync	Char	Hexadecimal 0x12	1	2
	4	Header Length	Uchar	Length of the header	1	3
	5	Message ID	Ushort	Message ID number	2	4
	6	Message Type	Char	Response Bit 1 = Response Message	1	6
	7	Port Address	Uchar	See <i>Table 4: Detailed Port Identifier</i> on page 33	1	7
	8	Message Length	Ushort	The length in bytes of the body of the message (not including the CRC)	2	8
	9	Sequence	Ushort	Normally 0	2	10
	10	Idle Time	Uchar	Idle time	1	12
	11	Time Status	Enum	<i>Table 11: GPS Reference Time Status</i> on page 47	1 ¹	13
	12	Week	Ushort	GPS reference week number	2	14
	13	ms	GPSec	Milliseconds into GPS reference week	4	16
	14	Receiver Status	Ulong	<i>Table 154: Receiver Status</i> on page 690	4	20
	15	Reserved	Ushort	Reserved	2	24
	16	Receiver S/W Version	Ushort	Receiver software build number	2	26
I D	17	Response ID	Enum	The enumeration value corresponding to the message response (<i>Table 222: Response Messages</i> on page 950)	4	28
H E X	18	Response	Hex	String containing the ASCII response in hex coding to match the ID above (for example, 0x4F4B = OK)	variable	32

¹This ENUM is not 4-bytes long but as indicated in the table is only 1 byte.

Table 9: Binary Message Sequence

Direction	Sequence	Data
To Receiver	LOG Command Header	AA44121C 01000240 20000000 1D1D0000 29160000 00004C00 55525A80
	LOG Parameters	20000000 2A000000 02000000 00000000 0000F03F 00000000 00000000
	Checksum	2304B3F1
From Receiver	LOG Response Header	AA44121C 01008220 06000000 FFB4EE04 605A0513 00004C00 FFFF5A80
	LOG Response Data	01000000 4F4B
	Checksum	DA8688EC
From Receiver	BESTPOSB Header	AA44121C 2A000220 48000000 90B49305 B0ABB912 00000000 4561BC0A
	BESTPOSB Data	00000000 10000000 1B0450B3 F28E4940 16FA6BBE 7C825CC0 0060769F 449F9040 A62A82C1 3D000000 125ACB3F CD9E983F DB664040 00303030 00000000 00000000 0B0B0000 00060003
	Checksum	42DC4C48

1.6 GLONASS Slot and Frequency Numbers

When a GLONASS PRN in a log is in the range 38 to 61, then that PRN represents a GLONASS Slot Number where the Slot Number shown is the actual GLONASS Slot Number plus 37.

Similarly, the GLONASS Frequency shown in logs is the actual GLONASS Frequency plus 7.

For example:

```
<RANGE COM1 0 82.0 FINESTEERING 1729 155076.000 02004000 5103 11465
46
31 0 24514687.250 0.064 -128825561.494675 0.010 3877.473 45.0 563.310
18109c04
...
46 5 24097664.754 0.213 -128680178.570435 0.014 -3740.543 40.6 10098.600
08119e44
...
8 0 39844800.076 0.043 -160438471.200694 0.013 -392.547 42.5 12038.660
00349c84
```

when 31 is a GPS satellite, 8 is a BeiDou satellite and 46 is a GLONASS satellite. Its actual GLONASS Slot Number is 9 and its frequency is -2.

Refer to *PRN Numbers* on the next page for more information about GLONASS PRN numbers. Also, refer to [An Introduction to GNSS](#) available on our website for more information.

1.6.1 PRN Numbers

The PRN and SVID ranges for the logs and commands that use them are shown in the following table.

Table 10: PRN Numbers for Commands and Logs

Command/Log	GPS PRN	SBAS PRN	SBAS QZSS L1S PRN	GLONASS Slot	Galileo SVID	QZSS PRN	BDS PRN	NavIC PRN
ASSIGN	1-32	120-158	183-192	38-61	1-36	193-202	1-30	1-7
ASSIGNALL	1-32	120-158	183-192	38-61	1-36	193-202	1-30	1-7
LOCKOUT	1-32	120-158	183-192	38-61	-	193-202	-	1-7
SBASCONTROL	-	120-158	183-192	-	-	-	-	-
TRACKSV	1-32	120-158	183-192	38-61	1-36	193-202	1-30	1-7
UNLOCKOUT	1-32	120-158	183-192	38-61	-	193-202	-	1-7
RANGE	1-32	120-158	183-192	38-61	1-36	193-202	1-30	1-7
RANGECMP	1-32	120-158	183-192	38-61	1-36	193-202	1-30	1-7
RANGECMP2	1-32	120-158	183-192	1-24	1-36	193-202	1-30	1-7
RANGECMP4	1-32	120-158	183-192	1-24	1-36	193-202	1-30	1-7
RANGEGPSL1	1-32	-	-	-	-	-	-	-
SATVIS2	1-32	120-158	183-192	1-24	1-36	193-202	1-30	1-7
TRACKSTAT	1-32	120-158	183-192	38-61	1-36	193-202	1-30	1-7

1.7 GPS Reference Time Status

All reported receiver times are subject to a qualifying time status. The status indicates how well a time is known (see *Table 11: GPS Reference Time Status* on the next page).

Table 11: GPS Reference Time Status

GPS Reference Time Status (Decimal)	GPS Reference Time Status (ASCII)	Description
20	UNKNOWN	Time validity is unknown
60	APPROXIMATE	Time is set approximately
80	COARSEADJUSTING	Time is approaching coarse precision
100	COARSE	This time is valid to coarse precision
120	COARSESTEERING	Time is coarse set and is being steered
130	FREEWHEELING	Position is lost and the range bias cannot be calculated
140	FINEADJUSTING	Time is adjusting to fine precision
160	FINE	Time has fine precision
170	FINEBACKUPSTEERING	Time is fine set and is being steered by the backup system
180	FINESTEERING	Time is fine set and is being steered
200	SATTIME	Time from satellite. Only used in logs containing satellite data such as ephemeris and almanac

If time is input to the receiver using the **SETAPPROXTIME** command (see page 283), the time status will be APPROXIMATE.

1.8 Message Time Stamps

All NovAtel format messages generated by the OEM7 and SMART2 receivers have a GPS reference time stamp in their header. GPS reference time is referenced to UTC with zero point defined as midnight on the night of January 5, 1980. The time stamp consists of the number of weeks since that zero point and the number of seconds since the last week number change (0 to 604,799). GPS reference time differs from UTC time since leap seconds are occasionally inserted into UTC and GPS reference time is continuous. In addition, a small error (less than 1 microsecond) can exist in synchronization between UTC and GPS reference time. The TIME log reports both GNSS and UTC time and the offset between the two.

The data in synchronous logs (for example, RANGE, BESTPOS, TIME) are based on a periodic measurement of satellite pseudoranges. The time stamp on these logs is the receiver estimate of GPS reference time at the time of the measurement.

Other log types (asynchronous and polled) are triggered by an external event and the time in the header may not be synchronized to the current GPS reference time. Logs that contain satellite broadcast data (for example, ALMANAC, GPSEPHM) have the transmit time of their last sub-frame in the header. In the header of differential time matched logs (for example, MATCHEDPOS) is the time of the matched reference and local observation that they are based on. Logs triggered by a mark event (for example, MARKPOS, MARK1TIME) have the estimated GPS reference time of the mark event in their header. In the header of polled logs (for example,

LOGLIST, PORTSTATS, VERSION) is the approximate GPS reference time when their data was generated. However, when asynchronous logs are triggered ONTIME, the time stamp will represent the time the log was generated and not the time given in the data.

For more information about log types, see *Log Types* on page 346.

1.9 Decoding of the GPS Reference Week Number

The GPS reference week number provided in the raw satellite data is the 10 least significant bits (or 8 least significant bits in the case of the almanac data) of the full week number. When the receiver processes the satellite data, the week number is decoded in the context of the current era and therefore is computed as the full week number starting from week 0 or January 6, 1980. Therefore, in all log headers and decoded week number fields, the full week number is given. Only in raw data, such as the *data* field of the **RAWALM** log (see page 645) or the *subframe* field of the **RAWEPHEM** log (see page 648), will the week number remain as the 10 (or 8) least significant bits.

1.10 32-Bit CRC

The ASCII and Binary OEM7 family and SMART2 message formats all contain a 32-bit CRC for data verification. This allows the user to ensure the data received (or transmitted) is valid with a high level of certainty.

The C functions below may be implemented to generate the CRC of a block of data.

```
#define CRC32_POLYNOMIAL 0xEDB88320L
/* -----
Calculate a CRC value to be used by CRC calculation functions.
----- */
unsigned long CRC32Value(int i) {
    int j;
    unsigned long ulCRC;
    ulCRC = i;
    for ( j = 8 ; j > 0; j-- ) {
        if ( ulCRC & 1 )
            ulCRC = ( ulCRC >> 1 ) ^ CRC32_POLYNOMIAL;
        else
            ulCRC >>= 1;
    }
    return ulCRC;
}

/* -----
Calculates the CRC-32 of a block of data all at once
ulCount - Number of bytes in the data block
ucBuffer - Data block
----- */
unsigned long CalculateBlockCRC32( unsigned long ulCount, unsigned char
*ucBuffer ) {
    unsigned long ulTemp1;
    unsigned long ulTemp2;
    unsigned long ulCRC = 0;
    while ( ulCount-- != 0 ) {
        ulTemp1 = ( ulCRC >> 8 ) & 0x00FFFFFFL;
        ulTemp2 = CRC32Value( ((int) ulCRC ^ *ucBuffer++ ) & 0xFF );
        ulCRC = ulTemp1 ^ ulTemp2;
    }
}
```



```

    }
    return( ulCRC );
}

```



The NMEA checksum is an XOR of all the bytes (including delimiters such as ',' but excluding the * and \$) in the message output. It is therefore an 8-bit and not a 32-bit checksum.

Not all logs may be available. Every effort is made to ensure examples are correct, however, a checksum may be created for promptness in publication. In this case it will appear as '9999'.

Example:

BESTPOSB and BESTPOSA from an OEM7 or SMART2 receiver.

Binary Log Message:

```

0xAA, 0x44, 0x12, 0x1C, 0x2A, 0x00, 0x02, 0x20, 0x48, 0x00, 0x00, 0x00,
0x90, 0xB4, 0x93, 0x05, 0xB0, 0xAB, 0xB9, 0x12, 0x00, 0x00, 0x00, 0x00,
0x45, 0x61, 0xBC, 0x0A, 0x00, 0x00, 0x00, 0x00, 0x10, 0x00, 0x00, 0x00,
0x1B, 0x04, 0x50, 0xB3, 0xF2, 0x8E, 0x49, 0x40, 0x16, 0xFA, 0x6B, 0xBE,
0x7C, 0x82, 0x5C, 0xC0, 0x00, 0x60, 0x76, 0x9F, 0x44, 0x9F, 0x90, 0x40,
0xA6, 0x2A, 0x82, 0xC1, 0x3D, 0x00, 0x00, 0x00, 0x12, 0x5A, 0xCB, 0x3F,
0xCD, 0x9E, 0x98, 0x3F, 0xDB, 0x66, 0x40, 0x40, 0x00, 0x30, 0x30, 0x30,
0x00, 0x00, 0x00, 0x00, 0x00, 0x00, 0x00, 0x00, 0x0B, 0x0B, 0x00, 0x00,
0x00, 0x06, 0x00, 0x03, 0x42, 0xdc, 0x4c, 0x48

```

Below is a demonstration of how to generate the CRC from both ASCII and BINARY messages using the function described above.



When you pass the data into the code that follows, exclude the checksum shown in ***bold italics*** above. It is *42dc4c48*.

Binary Checksum Calculation:

```

#include <stdio.h>
#include <string.h>
#include <inttypes.h>

void main() {
    // Expect checksum 0x42, 0xDC, 0x4C, 0x48 (42dc4c48)
    unsigned char buffer[] = {0xAA, 0x44, 0x12, 0x1C, 0x2A, 0x00, 0x02, 0x20,
0x48, 0x00,
                                0x00, 0x00, 0x90, 0xB4, 0x93, 0x05, 0xB0, 0xAB,
0xB9, 0x12,
                                0x00, 0x00, 0x00, 0x00, 0x45, 0x61, 0xBC, 0x0A,
0x00, 0x00,
                                0x00, 0x00, 0x10, 0x00, 0x00, 0x00, 0x1B, 0x04,
0x50, 0xB3,
                                0xF2, 0x8E, 0x49, 0x40, 0x16, 0xFA, 0x6B, 0xBE,
0x7C, 0x82,

```

```
0x5C, 0xC0, 0x00, 0x60, 0x76, 0x9F, 0x44, 0x9F,
0x90, 0x40,
0xA6, 0x2A, 0x82, 0xC1, 0x3D, 0x00, 0x00, 0x00,
0x12, 0x5A,
0xCB, 0x3F, 0xCD, 0x9E, 0x98, 0x3F, 0xDB, 0x66,
0x40, 0x40,
0x00, 0x30, 0x30, 0x30, 0x00, 0x00, 0x00, 0x00,
0x00, 0x00,
0x00, 0x00, 0x0B, 0x0B, 0x00, 0x00, 0x00, 0x06,
0x00, 0x03};

//Note that the CRC on the binary data will be little-endian ordered.
unsigned long CRCle = CalculateBlockCRC32(sizeof(buffer), buffer);

//big-endian users (such as Atmel AVR32 users) may swap endianness as
follows
unsigned long CRCbe = __builtin_bswap32(CRCle);

printf("\n\n%s %lx \n", "Computed binary checksum (little-endian): ",
CRCle);
printf("%s %" PRIx32 "\n", "Computed binary checksum (big-endian): ",
CRCbe);

}
```

Note that the above checksum function (`CalculateBlockCRC32`) must also be included to execute this code.

ASCII Log Message:

```
#BESTPOSA,COM1,0,78.0,FINESTEERING,1427,325298.000,00000000,6145,2748;
SOL_COMPUTED,SINGLE,51.11678928753,-114.03886216575,1064.3470,-16.2708,
WGS84,2.3434,1.3043,4.7300,"",0.000,0.000,7,7,0,0,0,06,0,03*9c9a92bb
```

The checksum for this log is given above, it is `9c9a92bb`.

ASCII:

```
#include <stdio.h>
#include <string.h>

void main() {
    //Remember to escape " characters as \"
    char *msgBlock =
"BESTPOSA,COM1,0,78.0,FINESTEERING,1427,325298.000,00000000,\
6145,2748;SOL_COMPUTED,SINGLE,51.11678928753,-114.03886216575,\
1064.3470,-\
16.2708,WGS84,2.3434,1.3043,4.7300,\"\",0.000,0.000,7,7,0,0,0,06,0,03";

    unsigned long CRC = CalculateBlockCRC32(strlen(msgBlock), (unsigned
char*)msgBlock);

    printf("\n\n%s %s\n", "Demonstrating CRC computed for the block:",
msgBlock);
    printf("\n\n%s %lu\n", "CRC32 in Decimal is: ", CRC);
    printf("%s %lx\n", "CRC32 in Hex is: ", CRC);
}
```

```
}
```

Note that the above checksum function (`CalculateBlockCRC32`) must also be included to execute this code.

Chapter 2 Agriculture GNSS Commands

The commands used to configure the receiver and GNSS functions are described in the following sections.

For information about SPAN specific commands, refer to the *Agriculture SPAN Commands* on page 809.

2.1 Command Formats

The receiver accepts commands in 3 formats as described in *Messages* on page 27:

- Abbreviated ASCII
- ASCII
- Binary

Abbreviated ASCII is the easiest to use for your input. The other two formats include a CRC for error checking and are intended for use when interfacing with other electronic equipment.

The following are examples of the same command in each format:

Abbreviated ASCII Example:

```
LOG COM1 BESTPOSB ONTIME 1[CR]
```

ASCII Example:

```
#LOGA,THISPORT,0,0,UNKNOWN,0,0.0,0,0,0;COM1,BESTPOSB,ONTIME,1.000000,0.000000,N  
OHOLD*ec9ce601[CR]
```

Binary Example:

```
AA44121C 010000C0 20000000 00FF0000 00000000 00000000 00000000 20000000  
2A000000 02000000 00000000 0000F03F 00000000 00000000 00000000 34D32DC1
```

2.1.1 Optional Parameters

Many commands have nested optional parameters where an optional parameter requires the optional parameter before it to be present. This is noted in the Abbreviated ASCII Syntax as:

```
Command [OPT_1 [OPT_2 [OPT_3]]]
```

In this syntax example, OPT_1 and OPT_2 must be provided if you want to provide a value for OPT_3. These leading two options are required even if you want to use the defaults for OPT_1 and OPT_2.

2.2 Command Settings

There are several ways to determine the current command settings of the receiver:

1. Request an **RXCONFIG** log (see page 684). This log provides a listing of all commands issued to the receiver and their parameter settings. It also provides the most complete information.
2. For some specific commands, logs are available to indicate all their parameter settings. The **LOGLIST** log (see page 507) shows all active logs in the receiver beginning with the **LOG** command (see page 174).

- Request a log of the specific command of interest to show the parameters last entered for that command. The format of the log produced is exactly the same as the format of the specific command with updated header information.



Requesting a log for specific command is useful for most commands. For commands repeated with different parameters (for example, **SERIALCONFIG** and **LOG**), only the most recent set of parameters used is shown. To view all sets of parameters, try method 1 or 2 above.

Abbreviated ASCII Example:

```
log fix
<FIX COM1 0 49.5 FINESTEERING 2072 405099.446 02000008 37d7 15761
<      NONE -10000.000000000000 -10000.000000000000 -10000.0000
```

2.3 Command Defaults

When the receiver is first powered up or after a **FRESET** command (see page 127), all commands revert to their factory default settings. When you use a command without specifying its optional parameters, it may have a different command default than the factory default. The **SAVECONFIG** command (see page 262) can be used to save these defaults. Use the **RXCONFIG** log (see page 684) to reference any default command and log settings.

Factory default settings for individual commands are stated in the following commands, organized alphabetically by command name.



FRESET STANDARD causes all previously stored user configurations saved to non-volatile memory to be erased (including Saved Config, Saved Almanac, Saved Ephemeris and L-Band-related data, excluding subscription information).



Ensure that all windows, other than the Console window, are closed in NovAtel's Connect user interface application before you issue the **SAVECONFIG** command (see page 262).

2.4 ALIGNAUTOMATION

Configures ALIGN plug-and-play feature

Platform: OEM719, OEM729, OEM7500, OEM7600, OEM7700, OEM7720, PwrPak7, SPAN CPT7, SMART7, SMART2

This command configures the ALIGN plug and play feature. Use this command to enable/disable the plug and play feature, to set the rover COM port to which master is connected, to set the baud rate for communication, to set the intended operation rate using this command and to enable/disable sending the HEADINGEXTB/HEADINGEXT2B back to the Master receiver. Refer to the NovAtel application note [APN-048](#) for details on HEADINGEXT (available on our website at www.novatel.com/support/).

On issuing this command at the ALIGN Rover, the Rover will automatically sync with the Master and configure it to send corrections at the specified baud rate and specified data rate.



This command should only be issued at ALIGN Rover.

Message ID: 1323

Abbreviated ASCII Syntax:

```
ALIGNAUTOMATION option [comport] [baudrate] [datarate] [headingextboption]
[interfacemode]
```

Factory Default:

```
ALIGNAUTOMATION disable
```

Example:

```
ALIGNAUTOMATION enable com2 230400 10 ON
```

Field	Field Type	ASCII Value	Binary Value	Description	Format	Binary Bytes	Binary Offset
1	ALIGN AUTOMATION header	-	-	Command header. See <i>Messages</i> on page 27 for more information.	-	H	0
2	option	ENABLE	1	Enable or disable the plug-and-play feature	Enum	4	H
		DISABLE	0				
3	comport	COM1, COM2 or COM3		Rover COM port to which master is connected (<i>Table 51: COM Port Identifiers</i> on page 278) (default=COM2)	Enum	4	H+4

Field	Field Type	ASCII Value	Binary Value	Description	Format	Binary Bytes	Binary Offset
4	baudrate	9600, 19200, 38400, 57600, 115200, 230400 or 460800		Intended baud rate for data transmission (default=230400)	Ulong	4	H+8
5	datarate	1, 2, 4, 5, 10 or 20		Rate (in Hz) at which heading output is required (default=10 Hz)	Ulong	4	H+12
6	headingextb option	OFF	0	Enable or disable sending HEADINGEXTB/ HEADINGEXT2B back to the Master (default=ON)	Enum	4	H+16
		ON	1				
7	interfacemode	See Table 30: Serial Port Interface Modes on page 151		Serial port interface mode (default=None)	Enum	4	H+20

2.5 ASSIGN

Assigns a channel to a PRN

Platform: OEM719, OEM729, OEM7500, OEM7600, OEM7700, OEM7720, PwrPak7, SPAN CPT7, SMART7, SMART2



The **ASSIGN** command should only be used by advanced users.



1. Assigning SV channel sets the forced assignment bit in the channel tracking status field which is reported in the RANGE and TRACKSTAT logs.
2. Assigning a PRN to a SV channel does not remove the PRN from the search space of the automatic searcher; only the SV channel is removed (that is, the searcher may search and lock onto the same PRN on another channel). See *Table 10: PRN Numbers for Commands and Logs* on page 46 for the PRN available for the **ASSIGN** command.
3. GLONASS SVs cannot be assigned if there is no information on GLONASS frequencies and matching slot numbers.
4. OEM7 cards have 4 channels available for SBAS. They automatically use the healthy GEO satellites with the highest elevations. Use the **ASSIGN** command to enter a GEO PRN manually.
5. The **ASSIGN** and **UNASSIGN** commands are not accepted for L-Band channels. The **ASSIGNLBANDBEAM** command (see page 61) should be used for L-Band channels.
6. Manually assigned satellites are not reported in the **RANGECMP4** log (see page 631).

This command may be used to aid in the initial acquisition of a satellite by manually overriding the automatic satellite/channel assignment and reacquisition processes. The command specifies that the indicated tracking channel search for:

- a specified satellite
- at a specified Doppler frequency
- within a specified Doppler window

The instruction remains in effect for the specified SV channel and PRN, even if the assigned satellite is below the elevation cutoff. If the satellite Doppler offset of the assigned SV channel exceeds that specified by the window parameter of the **ASSIGN** command, the satellite may never be acquired or reacquired. If a channel has been manually assigned, and the channel is changed to AUTO tracking, then the channel is idled immediately and returns to automatic mode.

To cancel the effects of **ASSIGN**, issue one of the following:

- The **ASSIGN** command with the state set to AUTO
- The **UNASSIGN** command (see page 314)
- The **UNASSIGNALL** command (see page 316)

These immediately return SV channel control to the automatic search engine

Message ID: 27

Abbreviated ASCII Syntax:

```
ASSIGN channel [state] [prn [Doppler [Doppler window]]]
```

ASCII Example 1:

```
ASSIGN 0 ACTIVE 29 0 2000
```

In example 1, the first SV channel is searching for satellite PRN 29 in a range from -2000 Hz to 2000 Hz until the satellite signal is detected.

ASCII Example 2:

```
ASSIGN 11 28 -250 0
```

SV channel 11 is searching for satellite PRN 28 at an offset of -250 Hz only.

ASCII Example 3:

```
ASSIGN 11 IDLE
```

SV channel 11 is idled and does not attempt to search for satellites.



For dual antenna receivers:

- On the primary antenna, the SV channel is from 0 to N-1, where N is the number of channels in the primary antenna channel configuration.
- On the secondary antenna, the SV channel count is from at N to N+(M-1), where M is the number of channels in the secondary antenna SV channel configuration.
- Even though L-Band channels cannot be configured with the **ASSIGN** command, they are included when determining N.

Field	Field Type	ASCII Value	Binary Value	Description	Format	Binary Bytes	Binary Offset
1	ASSIGN header	-	-	Command header. See <i>Messages</i> on page 27 for more information.	-	H	0
2	channel	0 to n-1, where n is the maximum number of GNSS channels in the current channel configuration		Desired SV channel number where channel 0 is the first SV channel. The last channel depends on the model configuration.	Ulong	4	H
3	state	Refer to <i>Table 12: Channel State</i> on the next page		Set the SV channel state. If a value is not given, the default of ACTIVE is used when the additional optional parameters are entered.	Enum	4	H+4

Field	Field Type	ASCII Value	Binary Value	Description	Format	Binary Bytes	Binary Offset
4	prn	Refer to <i>PRN Numbers</i> on page 46		Optional satellite PRN number. A value must be entered unless the state parameter is IDLE or AUTO.	Ulong	4	H+8
5	Doppler	-100 000 to 100 000 Hz		Current Doppler offset of the satellite. (default=0) Note: Satellite motion, receiver antenna motion and receiver clock frequency error must be included in the calculation of Doppler frequency.	Long	4	H+12
6	Doppler window	0 to 10 000 Hz		Error or uncertainty in the Doppler estimate above. (default=4500) Note: This is a \pm value. Example: 500 for \pm 500 Hz	Ulong	4	H+16

Table 12: Channel State

Binary	ASCII	Description
0	IDLE	Set the SV channel to not track any satellites
1	ACTIVE ¹	Set the SV channel active (default)
2	AUTO	Tell the receiver to automatically assign PRN numbers to channels

¹A PRN number is required when using the ACTIVE channel state in this command.

2.6 ASSIGNALL

Assigns all channels of a satellite system

Platform: OEM719, OEM729, OEM7500, OEM7600, OEM7700, OEM7720, PwrPak7, SPAN CPT7, SMART7, SMART2



The **ASSIGNALL** command should only be used by advanced users.

This command is used to override the automatic satellite channel algorithms with manual instructions for all channels in a satellite system.

Message ID: 28

Abbreviated ASCII Syntax:

```
ASSIGNALL [system][state][prn [Doppler [Doppler window]]]
```

ASCII Example 1:

```
ASSIGNALL GLONASS IDLE
```

In example 1, all GLONASS channels are idled, essentially stopping the receiver from tracking GLONASS.

ASCII Example 2:

```
ASSIGNALL GLONASS AUTO
```

In example 2, all GLONASS channels are enabled in auto mode. This enables the receiver to automatically assign channels to track the available GLONASS satellites.



This command is the same as ASSIGN except that it affects all SV channels of the specified satellite system.



These command examples are only applicable to specific receiver models. If the system field is used with this command and the receiver has no channels configured with that satellite system, the command is rejected.

Field	Field Type	ASCII Value	Binary Value	Description	Format	Binary Bytes	Binary Offset
1	ASSIGN-ALL header	-	-	Command header. See <i>Messages</i> on page 27 for more information.	-	H	0
2	system	See <i>Table 13: Satellite System</i> on the next page		Satellite system to assign. If no value is specified, the value defaults to ALL.	Enum	4	H

Field	Field Type	ASCII Value	Binary Value	Description	Format	Binary Bytes	Binary Offset
3	state	Refer to <i>Table 12: Channel State</i> on page 58)		Set the SV channel state.	Enum	4	H+4
4	prn	Refer to <i>PRN Numbers</i> on page 46		Optional satellite PRN code. A value must be entered if the state parameter is neither IDLE or AUTO.	Ulong	4	H+8
5	Doppler	-100 000 to 100 000 Hz		Current Doppler offset of the satellite. (default=0) Note: Satellite motion, receiver antenna motion and receiver clock frequency error must be included in the calculation of Doppler frequency.	Long	4	H+12
6	Doppler window	0 to 10 000 Hz		Error or uncertainty in the Doppler estimate above. (default=4500) Note: This is a \pm value Example, 500 for \pm 500 Hz	Ulong	4	H+16

Table 13: Satellite System

Binary	ASCII	Description
3	ALL	All systems
99	GPS	GPS system
100	SBAS	SBAS system
101	GLONASS	GLONASS system
102	GALILEO	GALILEO system
103	BeiDou	BeiDou system
104	QZSS	QZSS system
105	NAVIC	NavIC system



GLONASS SVs cannot be assigned if there is no information on GLONASS frequencies and matching slot numbers.

2.7 ASSIGNLBANDBEAM

Configure L-Band tracking

Platform: OEM719, OEM729, OEM7500, OEM7600, OEM7700, OEM7720, PwrPak7, SPAN CPT7, SMART7, SMART2

This command assigns TerraStar or Veripos beams to the L-Band channels based on the defined L-Band assignment option.



Logging the **ASSIGNLBANDBEAM** command may not display the correct values. To access the actual beam name, frequency and baud rate values, log the **LBANDTRACKSTAT** log (see page 504) or if the beam name is known, log the **LBANDBEAMTABLE** log (see page 502) and find the associated frequency and baud rate.

Message ID: 1733

Abbreviated ASCII Syntax:

```
ASSIGNLBANDBEAM [option] [name] [frequency] [baudrate] [Dopplerwindow]
```

Factory Default:

```
ASSIGNLBANDBEAM idle
```

ASCII Examples:

```
ASSIGNLBANDBEAM auto
```

```
ASSIGNLBANDBEAM 98W
```

```
ASSIGNLBANDBEAM manual 98w 1545865000 1200
```

Field	Field Type	Description	Format	Binary Bytes	Binary Offset
1	ASSIGNLBANDBEAM header	Command header. See <i>Messages</i> on page 27 for more information.	-	H	0
2	Option	Assignment option (see <i>Table 14: L-Band Assignment Option</i> on the next page) (manual=default)	Enum	4	H
3	Name	Beam name (empty string=default)	Char[8]	8	H+4
4	Frequency	Beam frequency in Hz (0=default)	Ulong	4	H+12
5	Baud rate	Data baud rate (0=default)	Ulong	4	H+16
6	Doppler window	Doppler window to search (6000=default)	Ulong	4	H+20

Table 14: L-Band Assignment Option

ASCII	Binary	Description
IDLE	0	Idle all L-Band channels
AUTO	1	The receiver searches for multiple L-Band beams on the L-Band channels based on AUTO selection criteria. If the receiver position is known, the AUTO selection criteria is a ranking of granted access L-Band beams by descending elevation angle. If the receiver position is not known, the AUTO selection criteria is a ranking of granted access L-Band beams in the order they appear in the stored beam table (see the LBANDBEAMTABLE log on page 502).
MANUAL	2	The receiver assigns the specified beam on the first L-BAND channel and makes the other L-BAND channels IDLE.

2.8 AUTH

Authorization code for different model

Platform: OEM719, OEM729, OEM7500, OEM7600, OEM7700, OEM7720, PwrPak7, SPAN CPT7, SMART7, SMART2

This command is used to add or remove authorization codes from the receiver. Authorization codes are used to authorize models of software for a receiver. Models control the functionality the receiver provides. The receiver is capable of keeping track of 24 authorization codes at one time. The **MODEL** command (see page 188) can then be used to switch between authorized models. The **VALIDMODELS** command (see page 794) lists the current available models in the receiver. The **AUTHCODES** log (see page 356) lists all authorization codes entered into the receiver. This simplifies the use of multiple software models on the same receiver.

If there is more than one valid model in the receiver, the receiver either uses the model of the last auth code entered via the **AUTH** command or the model that was selected by the **MODEL** command, whichever was done last. Adding an authorization code or using the **MODEL** command causes an automatic reset of the receiver. Removing an authorization code does not cause a reset.



Removing an authorization code will cause the receiver to permanently lose this information.

Message ID: 49

Abbreviated ASCII Syntax:

```
AUTH [state] part1 part2 part3 part4 part5 model [date]
```

Input Example:

```
AUTH add T48JF2,W25DBM,JH46BJ,2WGHMJ,8JW5TW,G2SR0RCCR,101114
```

```
AUTH erase_table PW5W2B,WW5TM9,WW2PCZ,WW3M4H,WW4HPG,ERASE_AUTH
```



When you are ready to upgrade from one model to another, call 1-800-NOVATEL to speak with our Customer Support/Sales Personnel, who can provide the authorization code that unlocks the additional features of your GNSS receiver. This procedure can be performed at your work site and takes only a few minutes.

Receiver models can also be downgraded. This is a two step handshaking process and is best performed in a location with e-mail access.



Field	Field Type	ASCII Value	Binary Value	Description	Format	Binary Bytes	Binary Offset
1	AUTH header	-	-	Command header. See <i>Messages</i> on page 27 for more information.	-	H	0

Field	Field Type	ASCII Value	Binary Value	Description	Format	Binary Bytes	Binary Offset
2	state	See Table 15: AUTH Command State below		Authorization code function to perform	Enum	4	H
3	part1	6 character ASCII string		Authorization code section 1	String [max. 16]	Variable ¹	H+4
4	part2	6 character ASCII string		Authorization code section 2	String [max. 16]	Variable ¹	H+20
5	part3	6 character ASCII string		Authorization code section 3	String [max. 16]	Variable ¹	H+36
6	part4	6 character ASCII string		Authorization code section 4	String [max. 16]	Variable ¹	H+52
7	part5	6 character ASCII string		Authorization code section 5	String [max. 16]	Variable ¹	H+68
8	model	Alpha numeric	Null terminated	Model name of the receiver	String [max. 16]	Variable ¹	H+84
9	date	Numeric	Null terminated	Expiry date entered as yymmdd in decimal	String [max 7]	Variable ¹	Variable

Table 15: AUTH Command State

ASCII	Binary	Description
REMOVE	0	Remove the authorization code from the system <div style="border: 1px solid black; padding: 5px; margin-top: 10px;">  For this parameter, the Part1-Part5 fields can be entered as 0 0 0 0, and only the model name entered. </div>
ADD	1	Add the authorization code to the system (default)
ADD_DOWNLOAD	4	Add the authorization code to the system (Deprecated: Use ADD instead)

¹In the binary case, each string field needs to be NULL terminated and additional bytes of padding added to maintain 4-byte alignment, up to the maximum defined by the string size. The next defined field starts immediately at the next 4-byte alignment following the NULL.

ASCII	Binary	Description
ERASE_ TABLE	7	<p>Erase all authorization codes from the system. Requires a special authorization code to prevent against accidental erasing.</p> <div style="border: 1px solid black; padding: 5px; margin-top: 10px;">  The special authorization code required for this option is: PW5W2B,WW5TM9,WW2PCZ,WW3M4H,WW4HPG,ERASE_AUTH </div>
CLEAN_ TABLE	8	<p>Remove all invalidated authorization codes from the system.</p> <p>When an authorization code is removed, it is simply invalidated and so it still uses one of the 24 spaces reserved for authorization codes in the receiver. Use the CLEAN_TABLE option to free up the spaces from removed authorization codes.</p> <div style="border: 1px solid black; padding: 5px; margin-top: 10px;">  The special authorization code required for this option is: 4DR69H,G369W8,34MNJJ,5NHXCJ,GW7C75,CLEAN_AUTH </div>

2.9 AUTOSURVEY

Survey for accurate position

Platform: OEM719, OEM729, OEM7500, OEM7600, OEM7700, OEM7720, PwrPak7, SPAN CPT7, SMART7

The **AUTOSURVEY** command uses position averaging to automatically determine the position for a base station.

When the **AUTOSURVEY** command is sent, the receiver starts position averaging. The position averaging continues until a specified accuracy level is met or until the specified survey time expires. When position averaging is complete, the calculated position is saved as the fix position for the base station. This calculated position is then used when transmitting differential corrections to the rover.



The **AUTOSURVEY** command computes the base position in WGS84.



If the **FIX** command is entered by a user, the **SAVECONFIG** command must then be issued to save to NVM. If the **FIX** command is issued by the AUTOSURVEY feature, the **SAVECONFIG** command does not need to be issued, because it is automatically saved to NVM.

On subsequent power ups or resets, an AUTOSURVEY runs to determine if the base station has moved. As the AUTOSURVEY runs, the average position calculated is compared to the saved fix position. If the average position is within the AUTOSURVEY tolerance setting, the receiver assumes it has not moved and uses the previously saved fix position. If the average position is outside of the AUTOSURVEY tolerance setting, the receiver assumes it has moved and will continue calculating a position average until the accuracy level is met or until the specified survey time expires.

The surveyed positions saved using the **AUTOSURVEY** command can be viewed using the **SAVEDSURVEYPOSITIONS** log on page 718. Surveyed positions can be added or deleted using the **SURVEYPOSITION** command on page 298.

Message ID: 1795

Abbreviated ASCII Syntax:

```
AUTOSURVEY control [time] [accuracy] [tolerance] [save_nvm] [position_id]
```

Input Example:

In the following example, the receiver is set up to survey its position for up to 24 hours or until the averaged position accuracy is 10 cm. On subsequent power ups at the same location, the survey will terminate as soon as the receiver determines the position is within 4 m of its surveyed position. Once the receiver has fixed its position, it will transmit RTCMV3 corrections over COM2.

```
SERIALCONFIG COM2 115200 N 8 1 N ON
INTERFACEMODE COM2 NONE RTCMV3 OFF
LOG COM2 RTCM1004 ONTIME 1
```

```

LOG COM2 RTCM1012 ONTIME 1
LOG COM2 RTCM1006 ONTIME 10
LOG COM2 RTCM1033 ONTIME 10
LOG COM2 RTCM1019 ONTIME 120
AUTOSURVEY ENABLE 1440 .1 4
SAVECONFIG

```

Field	Field Type	ASCII Value	Binary Value	Description	Format	Binary Bytes	Binary Offset
1	AUTOSURVEY header	-	-	Command header. See <i>Messages</i> on page 27 for more information.	-	H	0
2	control	disable	0	Disables the self-survey feature and halts any self-survey related activity (default = disable)	Enum	4	H
		enable	1	Enables the self-survey feature			
3	time	1 - 6000 minutes		Maximum amount of time to perform self-survey (default = 1440 minutes)	Ulong	4	H+4
4	accuracy	0 - 100 meters		Desired horizontal standard deviation (default = 0.1 meters)	Float	4	H+8
5	tolerance	3 - 100 meters		Maximum distance between calculated position and saved position. During the self-survey, if the distance between the calculated position and the previously surveyed position is less than this value, the previous position is used. (default = 10 meters)	Float	4	H+12
6	save_nvm	OFF	0	Do not save position in NVM	Enum	4	H+16
		ON	1	Save position in NVM (default = ON)			

Field	Field Type	ASCII Value	Binary Value	Description	Format	Binary Bytes	Binary Offset
7	position_id	4 character string		ID for the saved position. If the ID is not specified or if the ID is entered as "AUTO", receiver automatically generates a unique ID for the position. Note: This ID is the ID for the surveyed position, not the station ID set using the DGPSTXID command on page 105.	String [5]	5 ¹	H+20

¹In the binary case, each string field needs to be NULL terminated and additional bytes of padding added to maintain 4-byte alignment, up to the maximum defined by the string size. The next defined field starts immediately at the next 4-byte alignment following the NULL.

2.10 BASEANTENNAPCO

Sets the PCO model of the base receiver

Platform: OEM719, OEM729, OEM7500, OEM7600, OEM7700, OEM7720, PwrPak7, SPAN CPT7, SMART7

Use the **BASEANTENNAPCO** command to set the Phase Center Offsets (PCO) for a given frequency on the remote base receiver from which this receiver is receiving corrections. The Offsets are defined as North, East and Up from the Antenna Reference Point to the Frequency Phase Center in millimeters.

Message ID: 1415

Abbreviated ASCII Syntax:

```
BASEANTENNAPCO Frequency NorthOffset EastOffset UpOffset [CorrectionType
[StationId]]
```

ASCII Example:

```
BASEANTENNAPCO GPSL1 0.61 1.99 65.64
```

Field	Field Type	ASCII Value	Binary Value	Description	Format	Binary Bytes	Binary Offset
1	BASEANTENNAPCO header	-	-	Command header. See <i>Messages</i> on page 27 for more information.	-	H	0
2	Frequency	See Table 16: <i>Frequency Type</i> on the next page		The frequency that the phase center offsets are valid for.	Enum	4	H
3	NorthOffset			NGS standard Phase Center North Offset in millimeters.	Double	8	H+4
4	EastOffset			NGS standard Phase Center East Offset in millimeters.	Double	8	H+12
5	UpOffset			NGS standard Phase Center Up Offset in millimeters.	Double	8	H+20
6	CorrectionType	See Table 44: <i>RTK Source Type</i> on page 244		Correction type (default = AUTO)	Enum	4	H+28
7	StationID	Char [8] or ANY		ID string for the base station (default = ANY)	Char	8	H+32

Table 16: Frequency Type

Value	Name	Description
0	GPSL1	GPS L1 frequency
1	GPSL2	GPS L2 frequency
2	GLONASSL1	GLONASS L1 frequency
3	GLONASSL2	GLONASS L2 frequency
5	GPSL5	GPS L5 frequency
7	GALILEOE1	Galileo E1 frequency
8	GALILEOE5A	Galileo E5a frequency
9	GALILEOE5B	Galileo E5b frequency
10	GALILEOALTBOC	Galileo AltBOC frequency
11	BEIDOUB1	BeiDou B1 frequency
12	BEIDOUB2	BeiDou B2 frequency
13	QZSSL1	QZSS L1 frequency
14	QZSSL2	QZSS L2 frequency
15	QZSSL5	QZSS L5 frequency
16	QZSSL6	QZSS L6 frequency
17	GALILEOE6	Galileo E6 frequency
18	BEIDOUB3	BeiDou B3 frequency

2.11 BASEANTENNAPCV

Sets the PCV model of the base receiver

Platform: OEM719, OEM729, OEM7500, OEM7600, OEM7700, OEM7720, PwrPak7, SPAN CPT7, SMART7

Use the **BASEANTENNAPCV** command to set the Phase Center Variation (PCV) for a given frequency on the remote base receiver from which this receiver is receiving corrections. The Phase Center Variation entries follow the NGS standard and correspond to the phase elevation at 5 degree increments starting at 90 degrees and decreasing to 0.

Message ID: 1416

Abbreviated ASCII Syntax:

```
BASEANTENNAPCV Frequency [PCVArray [CorrectionType [StationId]]]
```

ASCII Example:

```
BASEANTENNAPCV GPSL1 0.00 -0.020 -0.07 -0.15 -0.24 -0.34 -0.43 -0.51 -0.56 -
0.61 -0.65 -0.69 -0.69 -0.62 -0.44 -0.13 0.28 0.70 1.02
```

Field	Field Type	ASCII Value	Binary Value	Description	Format	Binary Bytes	Binary Offset
1	BASEANTENNAPCV header	-	-	Command header. See <i>Messages</i> on page 27 for more information.	-	H	0
2	Frequency	See Table 16: <i>Frequency Type</i> on the previous page		The frequency for which the phase center variations are valid.	Enum	4	H
3	PCVArray			NGS standard 19 element array of phase center variations, in millimeters, in 5 degree elevation increments from 90 to 0. Defaults to zero for all elevation increments.	Double [19]	152	H+4
4	CorrectionType	See Table 44: <i>RTK Source Type</i> on page 244		Correction type (default = AUTO)	Enum	4	H+156
5	StationID	Char [8] or ANY		ID string (default = ANY)	Char	8	H+160

2.12 BASEANTENNATYPE

Sets the antenna type of the base receiver

Platform: OEM719, OEM729, OEM7500, OEM7600, OEM7700, OEM7720, PwrPak7, SPAN CPT7, SMART7

Use the **BASEANTENNATYPE** command to set the type of antenna type connected to the base receiver from which this receiver is receiving RTK corrections. The Antenna Type and Radome Type are the NGS names for the antenna.



When the antenna type is set using this command, the receiver will look up and use the Phase Center Variations and Phase Center Offsets from an internal table.

Message ID: 1419

Abbreviated ASCII Syntax:

```
BASEANTENNATYPE AntennaType [RadomeType] [CorrectionType] [StationId]
```

ASCII Examples:

```
BASEANTENNATYPE NOV702
```

```
BASEANTENNATYPE USER_ANTENNA_1
```

Field	Field Type	ASCII Value	Binary Value	Description	Format	Binary Bytes	Binary Offset
1	BASEANTENNATYPE header	-	-	Command header. See <i>Messages</i> on page 27 for more information.	-	H	0
2	AntennaType	See Table 17: <i>Antenna Type</i> on the next page		Antenna type	Enum	4	H
3	RadomeType	See Table 18: <i>Radome Type</i> on page 81		Radome type (default = NONE)	Enum	4	H+4
4	CorrectionType	See Table 44: <i>RTK Source Type</i> on page 244		Correction type (default = AUTO)	Enum	4	H+8
5	StationID	Char [8] or ANY		Base station ID (default = ANY)	Char	8	H+12



The latest information can be obtained from the National Geodetic Survey (NGS) site www.ngs.noaa.gov/ANTCAL.

Table 17: Antenna Type

Value	Name	Description
0	NONE	No antenna model
2	AUTO	Determine the antenna model from the RTK corrections (Not valid for THISANTENNATYPE)
3	AERAT2775_43	
4	AOAD_M_B	
5	AOAD_M_T	AOAD/M_T
6	AOAD_M_TA_NGS	AOAD/M_TA_NGS
7	APSAPS-3	
8	ASH700228A	
9	ASH700228B	
10	ASH700228C	
11	ASH700228D	
12	ASH700228E	
13	ASH700699.L1	
14	ASH700700.A	
15	ASH700700.B	
16	ASH700700.C	
17	ASH700718A	
18	ASH700718B	
19	ASH700829.2	
20	ASH700829.3	
21	ASH700829.A	
22	ASH700829.A1	
23	ASH700936A_M	
24	ASH700936B_M	
25	ASH700936C_M	
26	ASH700936D_M	
27	ASH700936E	

Value	Name	Description
28	ASH700936E_C	
29	ASH700936F_C	
30	ASH701008.01B	
31	ASH701073.1	
32	ASH701073.3	
33	ASH701933A_M	
34	ASH701933B_M	
35	ASH701933C_M	
36	ASH701941.1	
37	ASH701941.2	
38	ASH701941.A	
39	ASH701941.B	
40	ASH701945B_M	
41	ASH701945C_M	
42	ASH701945D_M	
43	ASH701945E_M	
44	ASH701945G_M	
45	ASH701946.2	
46	ASH701946.3	
47	ASH701975.01A	
48	ASH701975.01AGP	
49	JAV_GRANT-G3T	
50	JAV_RINGANT_G3T	
51	JAVRINGANT_DM	
52	JNSMARANT_GGD	
53	JPLD/M_R	
54	JPLD/M_RA_SOP	
55	JPSLEGANT_E	

Value	Name	Description
56	JPSODYSEY_I	
57	JPSREGANT_DD_E	
58	JPSREGANT_SD_E	
59	LEIAR10	
60	LEIAR25	
61	LEIAR25.R3	
62	LEIAR25.R4	
63	LEIAS05	
64	LEIAX1202GG	
65	LEIAS10	
66	LEIAX1203+GNSS	
67	LEIAT202+GP	
68	LEIAT202-GP	
69	LEIAT302+GP	
70	LEIAT302-GP	
71	LEIAT303	
72	LEIAT502	
73	LEIAT503	
74	LEIAT504	
75	LEIAT504GG	
76	LEIATX1230	
77	LEIATX1230+GNSS	
78	LEIATX1230GG	
79	LEIAX1202	
80	LEIGG02PLUS	
81	LEIGS08	
82	LEIGS09	
83	LEIGS12	

Value	Name	Description
84	3S-02-TSADM	
85	3S-02-TSATE	
86	LEIGS15	
87	LEIMNA950GG	
88	LEISR299_INT	
89	LEISR399_INT	
90	LEISR399_INTA	
91	MAC4647942	
92	MPL_WAAS_2224NW	
93	MPL_WAAS_2225NW	
94	MPLL1_L2_SURV	
95	NAVAN2004T	
96	NAVAN2008T	
97	NAX3G+C	
98	NOV_WAAS_600	
99	NOV501	
100	NOV501+CR	
101	NOV502	
102	NOV502+CR	
103	NOV503+CR	
104	NOV531	
105	NOV531+CR	
106	NOV600	
107	NOV702	
108	NOV702GG	
109	NOV750.R4	
110	SEN67157596+CR	
111	SOK_RADIAN_IS	

Value	Name	Description
112	SOK502	
113	SOK600	
114	SOK702	
115	SPP571212238+GP	
116	STXS9SA7224V3.0	
117	TOP700779A	
118	TOP72110	
119	TPSCR.G3	
120	TPSCR3_GGD	
121	TPSCR4	
122	TPSG3_A1	
123	TPSHIPER_GD	
124	TPSHIPER_GGD	
125	TPSHIPER_LITE	
126	TPSHIPER_PLUS	
127	TPSLEGANT_G	
128	TPSLEGANT2	
129	TPSLEGANT3_UHF	
130	TPSODYSSEY_I	
131	TPSPG_A1	
132	TPSPG_A1+GP	
133	TRM14177.00	
134	TRM14532.00	
135	TRM14532.10	
136	TRM22020.00+GP	
137	TRM22020.00-GP	
138	TRM23903.00	
139	TRM27947.00+GP	

Value	Name	Description
140	TRM27947.00-GP	
141	TRM29659.00	
142	TRM33429.00+GP	
143	TRM33429.00-GP	
144	TRM33429.20+GP	
145	TRM39105.00	
146	TRM41249.00	
147	TRM41249USCG	
148	TRM4800	
149	TRM55971.00	
150	TRM57970.00	
151	TRM57971.00	
152	TRM5800	
153	TRM59800.00	
154	TRM59800.80	
155	TRM59900.00	
156	TRMR8_GNSS	
157	TRMR8_GNSS3	
158	ASH701023.A	
159	CHCC220GR	
160	CHCC220GR2	
161	CHCX91+S	
162	GMXZENITH10	
163	GMXZENITH20	
164	GMXZENITH25	
165	GMXZENITH25PRO	
166	GMXZENITH35	
167	JAVRINGANT_G5T	

Value	Name	Description
168	JAVTRIUMPH_1M	
169	JAVTRIUMPH_1MR	
170	JAVTRIUMPH_2A	
171	JAVTRIUMPH_LSA	
172	JNSCR_C146-22-1	
173	JPSREGANT_DD_E1	
174	JPSREGANT_DD_E2	
175	JPSREGANT_SD_E1	
176	JPSREGANT_SD_E2	
177	LEIAR20	
178	LEIGG03	
179	LEIGS08PLUS	
180	LEIGS14	
181	LEIICG60	
182	NOV533+CR	
183	NOV703GGG.R2	
184	NOV750.R5	
185	RNG80971.00	
186	SEPCHOKE_B3E6	
187	SEPCHOKE_MC	
188	STXS10SX017A	
189	STXS8PX003A	
190	STXS9PX001A	
191	TIAPENG2100B	
192	TIAPENG2100R	
193	TIAPENG3100R1	
194	TIAPENG3100R2	

Value	Name	Description
195	TPSCR.G5	
196	TPSG5_A1	
197	TPSPN.A5	
198	TRM55970.00	
199	TRMR10	
200	TRMR4-3	
201	TRMR6-4	
202	TRMR8-4	
203	TRMR8S	
204	TRMSPS985	
205	AERAT1675_120	
206	ITT3750323	
207	NOV702GGL	
208	NOV704WB	
209	ARFAS1FS	
210	CHAPS9017	
211	CHCI80	
212	GMXZENITH15	
213	HXCCGX601A	
214	IGAIG8	
215	LEICGA60	
216	LEIGS15.R2	
217	LEIGS16	
218	MVEGA152GNSSA	
219	SEPALTUS_NR3	
220	SJTTL111	
221	SOKGCX3	
222	SOKSA500	

Value	Name	Description
223	STHCR3-G3	
224	STXS9I	
225	TPSCR.G5C	
226	TPSHIPER_HR	
227	TPSHIPER_HR+PS	
228	TRM105000.10	
229	TRM115000.00	
230	TRM115000.10	
231	TRMR2	
232	TWIVP6000	
233	TWIVP6050_CONE	
234	JAVTRIUMPH_2A+G	
235	JAVTRIUMPH_2A+P	
236	LEIGS18	
237	LEIGG04PLUS	
238	STXS800	
239	STXS800A	
240	NOV850	
241	TRM159800.00	
242	TRM159900.00	

Table 18: Radome Type

Value	Name
0	NONE
1	SPKE
2	SNOW
3	SCIS
4	SCIT
5	OLGA

Value	Name
6	PFAN
7	JVDM
8	LEIT
9	LEIC
10	LEIS
11	MMAC
12	NOVS
13	TPSH
14	CONE
15	TPSD
16	TCWD
17	UNAV
18	TZGD
19	CHCD
20	JAVC
21	LEIM
22	NOVC
23	ARFC
24	HXCS
25	JVGR
26	STHC
27	DUTD

2.13 BDSECUTOFF

Sets elevation cut-off angle for BeiDou satellites

Platform: OEM719, OEM729, OEM7500, OEM7600, OEM7700, OEM7720, PwrPak7, SPAN CPT7, SMART7, SMART2

This command is used to set the elevation cut-off angle for tracked BeiDou satellites. The receiver does not start automatically searching for a BeiDou satellite until it rises above the cut-off angle (when satellite position is known). Tracked satellites that fall below the cut-off angle are no longer tracked unless they are manually assigned (see the **ASSIGN** command on page 56).

In either case, satellites below the BDSECUTOFF angle are eliminated from the internal position and clock offset solution computations.

This command permits a negative cut-off angle; it could be used in these situations:

- The antenna is at a high altitude, and thus can look below the local horizon
- Satellites are visible below the horizon due to atmospheric refraction



Care must be taken when using **BDSECUTOFF** command because the signals from lower elevation satellites are traveling through more atmosphere and are therefore degraded. Use of satellites below 5 degrees is not recommended.



Use the **ELEVATIONCUTOFF** command on page 114 to set the cut-off angle for all other systems.



For dual antenna receivers, this command applies to both the primary and secondary antennas.

Message ID: 1582

Abbreviated ASCII Syntax:

```
BDSECUTOFF angle
```

Factory Default:

```
BDSECUTOFF 5.0
```

ASCII Example:

```
BDSECUTOFF 10.0
```

Field	Field Type	ASCII Value	Binary Value	Description	Format	Binary Bytes	Binary Offset
1	BDSECUTOFF header	-	-	Command header. See <i>Messages</i> on page 27 for more information.	-	H	0
2	angle	±90.0 degrees		Elevation cut-off angle relative to horizon	Float	4	H

2.14 BESTVELTYPE

Sets the velocity used in the BESTVEL and GPVTG logs

Platform: OEM719, OEM729, OEM7500, OEM7600, OEM7700, OEM7720, PwrPak7, SPAN CPT7, SMART7, SMART2

This command configures the source of the velocity that is output in the BESTVEL and GPVTG logs. Set the type to something other than BESTPOS when an unchanging velocity source with specific characteristics is needed.

The Doppler velocity is the highest-availability, lowest-latency velocity available from the receiver. Due to its low latency, it is also the noisiest velocity.

Message ID: 1678

Abbreviated ASCII Syntax:

```
BESTVELTYPE mode
```

Factory Default:

```
BESTVELTYPE bestpos
```

ASCII Example:

```
BESTVELTYPE doppler
```

Field	Field Type	Description	Format	Binary Bytes	Binary Offset
1	BESTVELTYPE header	Command header. See <i>Messages</i> on page 27 for more information.	-	H	0
2	mode	Velocity type (see <i>Table 19: Velocity Types</i> below)	Enum	4	H

Table 19: Velocity Types

ASCII	Binary	Description
BESTPOS	1	Use the velocity from the same positioning filter that is being used to fill BESTPOS and GPGGA
DOPPLER	2	Always fill BESTVEL and GPVTG using Doppler-derived velocities

2.15 BLUETOOTHCONTROL

Configure Bluetooth on the receiver

Platform: SMART2-B, SMART2-TB

The BLUETOOTHCONTROL command is used to set the Bluetooth operating mode.



Bluetooth® support for Apple® products requires that a custom application be developed.

Message ID: 2265

Abbreviated ASCII Syntax:

BLUETOOTH switch

Factory Default:

BLUETOOTHCONTROL ENABLE

Examples:

BLUETOOTHCONTROL ENABLE

BLUETOOTHCONTROL DISABLE

Field	Field Type	ASCII Value	Binary Value	Description	Format	Binary Bytes	Binary Offset
1	BLUETOOTH CONTROL header	-	-	Command header. See <i>Messages</i> on page 27 for more information.	-	H	0
2	Switch	DISABLE	0	Power off Bluetooth module	Enum	4	H+4
		ENABLE	1	Power on Bluetooth module and configure to support Bluetooth Serial Port Profile			
		LOAD	2	Load the Bluetooth firmware ¹			

¹The LOAD switch should not normally be necessary. In rare situations, it might be possible for the Bluetooth module firmware to become corrupt. The LOAD switch can be used to force the Bluetooth image to be reloaded onto the module to correct the situation. Once the firmware is loaded onto the module, Bluetooth functionality is enabled automatically.

2.16 CANCONFIG

Configure CAN ports

Platform: OEM719, OEM729, OEM7500, OEM7600, OEM7700, OEM7720, PwrPak7, SPAN CPT7, SMART7, SMART2

Use the CANCONFIG command to configure the hardware parameters of the CAN ports.

Message ID: 884

Abbreviated ASCII Syntax:

```
CANCONFIG port switch [speed]
```

Factory Default:

```
CANCONFIG CAN1 OFF 250K
```

```
CANCONFIG CAN2 OFF 250K
```

ASCII Example:

```
CANCONFIG CAN1 OFF 500K
```

Field	Field Type	ASCII Value	Binary Value	Description	Format	Binary Bytes	Binary Offset
1	CANCONFIG header	-	-	Command header. See <i>Messages</i> on page 27 for more information.	-	H	0
2	port	CAN1	1	Physical CAN port ID Note: The OEM7500 supports the CAN2 port only. Note: SMART2 does not support the CAN2 port	Enum	4	H
		CAN2	2				
3	switch	ON	1	Sets the port to be On or Off the CAN bus	Enum	4	H+4
		OFF	0				
4	speed	See <i>Table 20: CAN Port Speed</i> on the next page		Physical CAN port speed (bits per second) (default = 250K)	Enum	4	H+8



The CAN port must be set to OFF (using `CANCONFIG <port> OFF`) before the port speed can be changed.

Table 20: CAN Port Speed

ASCII Value	Binary Value
10K	0
20K	1
50K	2
100K	3
125K	4
250K	5
500K	6
1M	7

2.17 CCOMCONFIG

Configure the CAN COM port

Platform: OEM719, OEM729, OEM7500, OEM7600, OEM7700, OEM7720, PwrPak7, SPAN CPT7, SMART7

Bind a CAN communication port to a J1939 node (see **J1939CONFIG** command on page 170) and specify the CAN protocol, PGN, priority and address for messages transmitted and received over the CCOM port.



This command is not supported on the SMART2.

Message ID: 1902

Abbreviated ASCII Syntax:

```
CCOMCONFIG port node protocol [pgn [priority [address]]]
```

Factory Default:

```
CCOMCONFIG ccom1 node1 J1939 61184 7 fe
CCOMCONFIG ccom2 node2 J1939 61184 7 fe
CCOMCONFIG ccom3 node1 J1939 126720 7 fe
CCOMCONFIG ccom4 none none 0 0 0
CCOMCONFIG ccom5 none none 0 0 0
CCOMCONFIG ccom6 none none 0 0 0
```

ASCII Example :

```
ccomconfig ccom1 node1 j1939 1792 6 1b
```

Field	Field Type	ASCII Value	Binary Value	Description	Format	Binary Bytes	Binary Offset
1	CCOMCONFIG Header	-	-	Command header. See <i>Messages</i> on page 27 for more information.	-	H	0
2	port	CCOM1	38	Name of CCOM port.	Enum	4	H
		CCOM2	39				
		CCOM3	40				
		CCOM4	41				
		CCOM5	42				
		CCOM6	43				

Field	Field Type	ASCII Value	Binary Value	Description	Format	Binary Bytes	Binary Offset
3	node	NODE1	1	The J1939 node to use. This binds a CCOM port to the CAN NAME/address associated with the node.	Enum	4	H+4
		NODE2	2				
4	protocol	See <i>Table 21: CAN Protocol</i> on the next page		CAN transport protocol to use.	Enum	4	H+8
5	pgn	0 - 131071		Any valid PGN as defined by the J1939 protocol. All messages transmitted over this CCOM port will contain this PGN value. Only messages with this PGN will be received on this CCOM port. Note: This value is ignored if the protocol is NMEA2000.	Ulong	4	H+12
6	priority	0-7		Default CAN message priority for transmitted messages. (Priority 0 is the highest priority) Note: This value is ignored if the protocol is NMEA2000.	Uchar	1	H+16
7	address	00 – FF		00 – FD: Transmit and receive messages to/from this address only. FE: Transmit and receive message to/from the address of the first message received. FF: Broadcast messages and receive messages from all addresses. Note: This value is ignored if the protocol is NMEA2000.	Hex	1	H+17

Table 21: CAN Protocol

Binary	ASCII	Description
2	J1939	J1939 single packet
3	NMEA2000	NMEA2000 (single packet, multi-packet, fast packet)
5	ISO11783	ISO 11783 transport protocol

2.18 CLOCKCALIBRATE

Adjusts clock steering parameters

Platform: OEM719, OEM729, OEM7500, OEM7600, OEM7700, OEM7720, PwrPak7, SPAN CPT7, SMART7, SMART2

This command is used to adjust the control parameters of the clock steering loop.

The current values used by the clock steering process are listed in the **CLOCKSTEERING** command (see page 401).



The values entered using the **CLOCKCALIBRATE** command are saved to non-volatile memory (NVM). To restore the values to their defaults, the **FRESET CLKCALIBRATION** command must be used. Issuing FRESET without the CLKCALIBRATION parameter will not clear the values (see **FRESET** command on page 127 for more details).

Message ID: 430

Abbreviated ASCII Syntax:

```
CLOCKCALIBRATE [mode] [period] [pulsewidth] [slope] [bandwidth]
```

ASCII Example:

```
CLOCKCALIBRATE AUTO
```

Field	Field Type	ASCII Value	Binary Value	Description	Format	Binary Bytes	Binary Offset
1	CLOCK CALIBRATE header	-	-	Command header. See <i>Messages</i> on page 27 for more information.	-	H	0

Field	Field Type	ASCII Value	Binary Value	Description	Format	Binary Bytes	Binary Offset
2	mode	SET	0	Sets the period, pulsewidth, slope and bandwidth values into NVM for the currently selected steered oscillator. (INTERNAL or EXTERNAL)	Enum	4	H
		AUTO	1	Forces the receiver to do a clock steering calibration to measure the slope (change in clock drift rate with a 1 bit change in pulse width) and required pulsewidth to zero the clock drift rate. After the calibration, these values along with the period and bandwidth are entered into NVM and are then used from this point forward on the selected oscillator.			
		OFF	2	Terminates a calibration process currently underway. (default)			
3	period	0 to 262144		Signal period in 10 ns steps. Frequency Output = 100,000,000 / Period (default=11000)	Ulong	4	H+4
4	pulsewidth	The valid range for this parameter is 10% to 90% of the period		Sets the initial pulse width that should provide a near zero drift rate from the selected oscillator being steered. The valid range for this parameter is 10% to 90% of the period. If this value is not known, (in the case of a new external oscillator) then it should be set to ½ the period and the mode should be set to AUTO to force a calibration. (default=6600)	Ulong	4	H+8

Field	Field Type	ASCII Value	Binary Value	Description	Format	Binary Bytes	Binary Offset
5	slope			This value should correspond to how much the clock drift changes with a 1 bit change in the pulsewidth m/s/bit. The default values for the slope used for the INTERNAL and EXTERNAL clocks is -2.0 and -0.01 respectively. If this value is not known, then its value should be set to 1.0 and the mode should be set to AUTO to force a calibration. Once the calibration process is complete and using a slope value of 1.0, the receiver should be recalibrated using the measured slope and pulsewidth values (see the CLOCKSTEERING log on page 401). This process should be repeated until the measured slope value remains constant (less than a 5% change). (default=0.774)	Float	4	H+12
6	bandwidth			This is the value used to control the smoothness of the clock steering process. Smaller values result in slower and smoother changes to the receiver clock. Larger values result in faster responses to changes in oscillator frequency and faster start up clock pull in. The default values are 0.03 and 0.001 Hz respectively for the INTERNAL and EXTERNAL clocks. (default=0.03)	Float	4	H+16

2.19 COMCONTROL

Controls the serial port hardware control lines

Platform: OEM719, OEM729, OEM7500, OEM7600, OEM7700, OEM7720

This command is used to control the hardware control lines of the serial communication (COM) ports. The TOGGLEPPS mode of this command is typically used to supply a timing signal to a host PC computer by using the RTS and DTR lines. The accuracy of controlling the COM control signals is better than 900 μ s. The other modes are typically used to control custom peripheral devices.



1. If handshaking is disabled, any of these modes can be used without affecting regular serial communications through the selected COM port. However, if handshaking is enabled, it may conflict with handshaking of the selected COM port, causing unexpected results.
2. The PULSEPPSLOW control type cannot be issued for a TX signal.
3. Only PULSEPPSHIGH, FORCEHIGH and FORCELOW control types can be used for a TX signal.
4. To use the COM2 flow control signals, COM5 must be disabled. See OEM7600, OEM7700 and OEM7720 Multiplexed Port in the [OEM7 Installation and Operation User Manual](#) for more information.

Message ID: 431

Abbreviated ASCII Syntax:

```
COMCONTROL [port] [signal] [control]
```

Factory Default:

```
COMCONTROL COM1 RTS DEFAULT
COMCONTROL COM2 RTS DEFAULT
COMCONTROL COM3 RTS DEFAULT
COMCONTROL COM4 RTS DEFAULT
COMCONTROL COM5 RTS DEFAULT
```

ASCII Example 1:

```
SERIALCONFIG COM1 9600 N 8 1 N (to disable handshaking)
COMCONTROL COM1 RTS FORCELOW
```

ASCII Example 2:

```
COMCONTROL COM1 RTS TOGGLEPPS
COMCONTROL COM2 RTS TOGGLEPPS
```

ASCII Example 3:

To set a break condition on COM1:

```
COMCONTROL COM1 TX FORCELOW
```

A break condition remains in effect until it is cleared. To clear a break condition on COM1:

```
COMCONTROL COM1 TX DEFAULT
```

or

COMCONTROL COM1 TX FORCEHIGH

Field	Field Type	ASCII Value	Binary Value	Description	Format	Binary Bytes	Binary Offset
1	COM CONTROL header	-	-	Command header. See <i>Messages</i> on page 27 for more information.	-	H	0
2	port	COM1	1	Serial port to control.	Enum	4	H
		COM2	2				
		COM3	3				
		COM4	19				
		COM5	31				
3	signal	RTS	0	COM signal to control. The controllable COM signals are RTS, DTR and TX. (Default = RTS) See also <i>Table 22: Tx, DTR and RTS Availability</i> on the next page	Enum	4	H+4
		DTR	1				
		TX	2				

Field	Field Type	ASCII Value	Binary Value	Description	Format	Binary Bytes	Binary Offset
4	control	DEFAULT	0	Disables this command and returns the COM signal to its default state (Default)	Enum	4	H+8
		FORCEHIGH	1	Immediately forces the signal high			
		FORCELOW	2	Immediately forces the signal low			
		TOGGLE	3	Immediately toggles the current state of the signal			
		TOGGLEPPS	4	Toggles the state of the selected signal within 900 μ s after each 1PPS event. The state change of the signal lags the 1PPS by an average value of 450 μ s. The delay of each pulse varies by a uniformly random amount less than 900 μ s			
		PULSEPPSLOW	5	Pulses the line low at a 1PPS event and to high 1 ms after it. Not for TX			
		PULSEPPSHIGH	6	Pulses the line high for 1 ms at the time of a 1PPS event			

Table 22: Tx, DTR and RTS Availability

	Tx Available On	DTR Available On	RTS Available On
OEM719	COM1, COM2, COM3	N/A	N/A
OEM729	COM1, COM2, COM3	N/A	COM1 and COM2
OEM7600	COM1, COM2, COM3, COM4, COM5	N/A	COM1 and COM2
OEM7700	COM1, COM2, COM3, COM4, COM5	N/A	COM1 and COM2
OEM7720	COM1, COM2, COM3, COM4, COM5	N/A	COM1 and COM2

2.20 CONFIGCODE

Configuration Code

Platform: OEM719, OEM729, OEM7500, OEM7600, OEM7700, OEM7720, PwrPak7, SPAN CPT7, SMART7, SMART2

Configuration Codes can be used to make permanent changes to a receiver. These are configurations that persist even after non-volatile memory is cleared.



A configuration code is different from an auth code, which controls the functionality the receiver firmware provides.



This command writes to and reads from non-volatile memory. Therefore, it is required that the receiver maintain power throughout the execution of this command. Loss of power during this critical step could result in an unrecoverable error.

Message ID: 1041

Abbreviated ASCII Syntax:

```
CONFIGCODE [action] data1 data2 data3 data4 data5 description
```

Input Example:

```
CONFIGCODE ERASE_TABLE WJ4HDW,GM5Z99,T2M7DP,KG2T8T,KF7GKR, TABLECLEAR
```

Field	Field Type	ASCII Value	Binary Value	Description	Format	Binary Bytes	Binary Offset
1	CONFIGCODE header	-	-	Command header. See <i>Messages</i> on page 27 for more information.	-	H	0
2	action	See <i>Table 23: Configuration Actions</i> on the next page		Configuration action Default = ADD	Enum	4	H
3	data1			First data block	String [15]	Max. 16	H+4
4	data2			Second data block	String [15]	Max. 16	Variable
5	data3			Third data block	String [15]	Max. 16	Variable
6	data4			Fourth data block	String [15]	Max. 16	Variable

Field	Field Type	ASCII Value	Binary Value	Description	Format	Binary Bytes	Binary Offset
7	data5			Fifth data block	String [15]	Max. 16	Variable
8	description			Description of the config code	String [15]	Max. 16	Variable



In the binary case, each string field needs to be NULL terminated and additional bytes of padding added to maintain 4-byte alignment, up to the maximum defined by the string size. The next defined field starts immediately at the next 4-byte alignment following the NULL.

Table 23: Configuration Actions

Binary Value	ASCII Value	Description
0	REMOVE	Invalidate the specified configuration code.
1	ADD	Add the specified configuration code. (default)
3	ADD_NO_RESET	Add the specified configuration code without resetting the receiver.
7	ERASE_TABLE	Erase the entire configuration code table. This will only work with config code WJ4HDW,GM5Z99,T2M7DP,KG2T8T,KF7GKR,TABLECLEAR
8	CLEAN_TABLE	Clear the table of invalid configuration codes. This will only work with config code: 6296CN,W27KNX,W2MD4H,W5JBKG,W3BFPN,CLEAN_CONFIG.

2.21 DATUM

Select a datum transformation

Platform: OEM719, OEM729, OEM7500, OEM7600, OEM7700, OEM7720, PwrPak7, SPAN CPT7, SMART7, SMART2

This command is used to select the ellipsoid used for converting Cartesian co-ordinates to geodetic (latitude, longitude and height) and the transformation applied to positions calculated by the receiver before they are output.

The datum transformation selected by this command will be applied to **all** solutions calculated by the receiver. Solutions based on corrections, like RTK or pseudorange differential, will naturally be in the datum of the corrections; for example, RTK networks in North America will transmit corrections that position users in NAD83. Uncorrected solutions, meanwhile, will be in WGS84 or a datum closely-aligned to it. If different solutions are in different datums then a single transformation will not work in all cases. Care must therefore be taken when using this command.

With RTK, it is normally intended to position in the datum of the base station. A transformation applied to the natural solution will shift the solution out of the base station datum. Consequently, this command is generally not suitable for use with RTK.

Use of the factory default datum of WGS84 will result in no transformation being applied to any solution. User defined datums can also be used, after being created using the **USERDATUM** command (see page 325) or **USEREXPDATUM** command (see page 327).

Datum transformations matter mostly for precise solutions like PPP and RTK, where the difference between datums is large relative to the solution accuracy. As already outlined, RTK solutions are, typically, already in the desired datum. Therefore, in most cases only PPP solutions will need transforming. To transform only the PPP solution, use the **OUTPUTDATUM** command on page 204.



Do not mix the **DATUM USER** and **OUTPUTDATUM** commands.

Message ID: 160

Abbreviated ASCII Syntax:

DATUM datum

Factory Default:

DATUM WGS84

ASCII Example:

DATUM USER

Field	Field Type	ASCII Value	Binary Value	Description	Format	Binary Bytes	Binary Offset
1	DATUM header	-	-	Command header. See <i>Messages</i> on page 27 for more information.	-	H	0
2	datum	WGS84	61	World Geodetic System 84	Enum	4	H
		USER	63	User defined datum set by the USERDATUM command (see page 325) and USEREXPDATUM command (see page 327).			

2.22 DATUMTRANSFORMATION

Set user-defined datum transformation parameters

Platform: OEM719, OEM729, OEM7500, OEM7600, OEM7700, OEM7720, PwrPak7, SPAN CPT7, SMART7, SMART2

Use this command to add or remove user-defined datum transformations. Each entry converts from one geodetic datum in the **GEODETICDATUMS** list to another. Generally, "From" is the native service datum for one of the position types, such as ITRF2014 for TerraStar or Veripos, and "To" is a desired output datum. Entries are indexed by the pair "From" "To".



The **OUTPUTDATUM** command (see page 204) must be sent for any user-defined transformations to take effect.

The receiver firmware includes a default set of datum transformations. These default transformations cannot be deleted, but can be overwritten with user-defined parameters. A default transformation that has been overwritten can be reverted to the default parameters by deleting the transformation. User-defined transformations will persist a factory reset; all user-defined transformations can be removed by sending **FRESET USER_DATUM_TRANSFORMATION** (see the **FRESET** command on page 127).

The transformation used by this command is the 7 parameter Helmert transformation:

$$\begin{bmatrix} X_s \\ Y_s \\ Z_s \end{bmatrix} = \begin{bmatrix} T_x \\ T_y \\ T_z \end{bmatrix} + (1 + s) \begin{bmatrix} 1 & -R_z & R_y \\ R_z & 1 & -R_x \\ -R_y & R_x & 1 \end{bmatrix} \begin{bmatrix} X \\ Y \\ Z \end{bmatrix}$$

Where:

X, Y, Z are the coordinates in the input datum

X_s, Y_s, Z_s are the coordinates in the output datum

T_x, T_y, T_z are the translation parameters corrected for translation rate (meters)

R_x, R_y, R_z are the rotation parameters corrected for rotation rate (radians)

s is the scale difference corrected for scale rate (unitless)

A given parameter P is corrected for rate:

$$P(t) = P(t_r) + \dot{P}(t_r) (t - t_r)$$

Where:

t_r is the reference epoch of the parameters

t is the current epoch

P(t_r) is the parameter at the reference epoch

Ḑ(t_r) is the rate of the parameter at the reference epoch

The entry contains the reference epoch, value of each parameter at the reference epoch and rate of each parameter at the reference epoch. Both the user-defined and default transformations are reported by the **DATUMTRANSFORMATIONS** log (see page 404).

Message ID: 2297

Field	Field Type	ASCII Value	Binary Value	Description	Format	Binary Bytes	Binary Offset
9	rx			Rotations at the reference epoch (milliarcseconds)	Float	4	Variable
10	ry				Float	4	Variable
11	rz				Float	4	Variable
12	scale			Scale difference at the reference epoch (parts per billion)	Float	4	Variable
13	tx_vel			Translation rates (meters/year)	Float	4	Variable
14	ty_vel				Float	4	Variable
15	tz_vel				Float	4	Variable
16	rx_vel			Rotation rates (milliarcsecond/year)	Float	4	Variable
17	ry_vel				Float	4	Variable
18	rz_vel				Float	4	Variable
19	scale_vel			Scale difference rate (parts per billion/year)	Float	4	Variable

2.23 DGPSTXID

Sets DGPS station ID

Platform: OEM719, OEM729, OEM7500, OEM7600, OEM7700, OEM7720, PwrPak7, SPAN CPT7, SMART7, SMART2

This command is used to set the station ID value for the receiver when it is transmitting corrections. This allows for the easy identification of which base station was the source of the data.

For example, if you want to compare RTCM and RTCMV3 corrections, you would be easily able to identify their base stations by first setting their respective DGPSTXID values.

Message ID: 144

Abbreviated ASCII Syntax:

```
DGPSTXID type ID
```

Factory Default:

```
DGPSTXID auto ANY
```

ASCII Examples:

```
DGPSTXID RTCM 2 - using an RTCM type and ID
```

```
DGPSTXID CMR 30 - using a CMR type and ID
```

```
DGPSTXID CMR ANY - using the default CMR ID
```

```
DGPSTXID RTCA d36d - using an RTCA type and ID
```

```
DGPSTXID RTCMV3 2050 - using an RTCMV3 type and ID
```

Field	Field Type	ASCII Value	Binary Value	Description	Format	Binary Bytes	Binary Offset
1	DGPSTXID header	-	-	Command header. See <i>Messages</i> on page 27 for more information.	-	H	0
2	type	RTCM	0	See <i>Table 41: PSRDIFFSOURCE Type</i> on page 225	Enum	4	H
		RTCA	1				
		CMR	2				
		AUTO	10				
		RTCMV3	13				
3	ID	Char[5]		Base Station ID String See <i>Table 41: PSRDIFFSOURCE Type</i> on page 225	Char[5]	8	H+4

2.24 DNSCONFIG

Manually configures Ethernet DNS servers

Platform: OEM729, OEM7600, OEM7700, OEM7720, PwrPak7, SPAN CPT7, SMART7-I, SMART7-SI

This command is part of the Ethernet set up. It is used to configure the Domain Name Servers (DNS) so that host names can be used instead of IP addresses.



The **DNSCONFIG** command configures a DNS server for the Ethernet interface, ETHA.

The **DNSCONFIG** command will fail if the IP address for the Ethernet interface, ETHA, is configured to use DHCP. Ensure the IP address for the Ethernet interface is configured to use a static IP address before entering the **DNSCONFIG** command.

When using DHCP, the DNS server received using DHCP is used and the DNS server configured by **DNSCONFIG** is ignored.

Message ID: 1244

Abbreviated ASCII Syntax:

```
DNSCONFIG NumDNSSservers IP
```

Factory Default:

```
DNSCONFIG 0
```

ASCII Example:

```
DNSCONFIG 1 192.168.1.5
```

Field	Field Type	ASCII Value	Binary Value	Data Description	Format	Binary Bytes	Binary Offset
1	DNSCONFIG Header	-	-	Command header. See <i>Messages</i> on page 27 for more information.	-	H	0
2	NumDNSServers	0	0	Number of DNS servers	Enum	4	H
		1	1	If this field is set to 0, an IP address is not required.			
3	IP	ddd.ddd. ddd.ddd		IP address of primary DNS server	String [16]	variable ¹	H+4

¹In the binary case, each string field needs to be NULL terminated and additional bytes of padding added to maintain 4-byte alignment, up to the maximum defined by the string size. The next defined field starts immediately at the next 4-byte alignment following the NULL.

2.25 DYNAMICS

Tunes receiver parameters

Platform: OEM719, OEM729, OEM7500, OEM7600, OEM7700, OEM7720, PwrPak7, SPAN CPT7, SMART7, SMART2

This command is used to adjust the receiver dynamics to that of an application. It is used to optimally tune receiver parameters.

The **DYNAMICS** command adjusts the Tracking State transition time out value of the receiver, see *Table 122: Tracking State* on page 616. When the receiver loses the position solution, see *Table 65: Solution Status* on page 374, it attempts to steer the tracking loops for fast reacquisition (5 s time-out by default). The **DYNAMICS** command adjusts this time-out value, effectively increasing the steering time. The three states AIR, LAND or FOOT set the time-out to 5, 10 or 20 seconds respectively.



The **DYNAMICS** command should only be used by advanced users. The default of AUTO should **not** be changed except under very specific conditions.

Message ID: 258

Abbreviated ASCII Syntax:

```
DYNAMICS settings
```

Factory Default:

```
DYNAMICS AUTO
```

Example:

```
DYNAMICS FOOT
```

Field	Field Type	ASCII Value	Binary Value	Description	Format	Binary Bytes	Binary Offset
1	DYNAMICS header	-	-	Command header. See <i>Messages</i> on page 27 for more information.	-	H	0
2	settings	See <i>Table 24: User Dynamics</i> below		Receiver dynamics based on the current environment	Enum	4	H

Table 24: User Dynamics

Binary	ASCII	Description
0	AIR	Receiver is in an aircraft or a land vehicle, for example a high speed train, with velocity greater than 110 km/h (30 m/s). This is also the most suitable dynamic for a jittery vehicle at any speed.

Binary	ASCII	Description
1	LAND	Receiver is in a stable land vehicle with velocity less than 110 km/h (30 m/s).
2	FOOT	Receiver is being carried by a person with velocity less than 11 km/h (3 m/s).
3	AUTO	Receiver monitors dynamics and adapts behavior accordingly



Qualifying North American Solar Challenge cars annually weave their way through 1000's of miles between the US and Canada. GNSS keeps them on track through many intersections on secondary highways and gives the Calgary team constant intelligence on the competition's every move. In this case, with average speeds of 46 miles/hour and at times a jittery vehicle, AIR is the most suitable dynamic.

2.26 ECHO

Sets port echo

Platform: OEM719, OEM729, OEM7500, OEM7600, OEM7700, OEM7720, PwrPak7, SPAN CPT7, SMART7, SMART2

This command is used to set a port to echo.

Message ID: 1247

Abbreviated ASCII Syntax:

```
ECHO [port] echo
```

Factory Default:

```
ECHO COM1 OFF
```

```
ECHO COM2 OFF
```

```
ECHO COM3 OFF (not supported on OEM719)
```

```
ECHO COM4 OFF (OEM7600, OEM7700 and OEM7720 only)
```

```
ECHO COM5 OFF (OEM7600, OEM7700 and OEM7720 only)
```

```
ECHO USB1 OFF
```

```
ECHO USB2 OFF
```

```
ECHO USB3 OFF
```

```
ECHO ICOM1 OFF (not supported on OEM719)
```

```
ECHO ICOM2 OFF (not supported on OEM719)
```

```
ECHO ICOM3 OFF (not supported on OEM719)
```

```
ECHO ICOM4 OFF (not supported on OEM719)
```

```
ECHO ICOM5 OFF (not supported on OEM719)
```

```
ECHO ICOM6 OFF (not supported on OEM719)
```

```
ECHO ICOM7 OFF (not supported on OEM719)
```

```
ECHO SCOM1 OFF
```

```
ECHO SCOM2 OFF
```

```
ECHO SCOM3 OFF
```

```
ECHO SCOM4 OFF
```

ASCII Example:

```
ECHO COM1 ON
```

```
ECHO ON
```

Field	Field Type	ASCII Value	Binary Value	Description	Format	Binary Bytes	Binary Offset
1	ECHO Header	-	-	Command header. See <i>Messages</i> on page 27 for more information.	-	H	0
2	port	See <i>Table 25: Communications Port Identifiers</i> below		Port to configure (default = THISPORT)	Enum	4	H
3	echo	OFF	0	Sets port echo to off	Enum	4	H+4
		ON	1	Sets port echo to on			

Table 25: Communications Port Identifiers

ASCII Port Name	Binary Value
ALL	8
BT1	33
CCOM1	38
CCOM2	39
CCOM3	40
CCOM4	41
CCOM5	42
CCOM6	43
COM1	1
COM2	2
COM3	3
COM4	19
COM5	31
COM6	32
COM7	34
COM8	35
COM9	36
COM10	37

ASCII Port Name	Binary Value
ETH1	20
FILE	7
ICOM1	23
ICOM2	24
ICOM3	25
ICOM4	29
ICOM5	46
ICOM6	47
ICOM7	48
IMU	21
NCOM1	26
NCOM2	27
NCOM3	28
NOPORT	0
SCOM1	49
SCOM2	50
SCOM3	51
SCOM4	52
THISPORT	6
USB1	13
USB2	14
USB3	15
WCOM1	30

2.27 ECUTOFF

Sets satellite elevation cut-off for GPS Satellites

Platform: OEM719, OEM729, OEM7500, OEM7600, OEM7700, OEM7720, PwrPak7, SPAN CPT7, SMART7, SMART2

This command is used to set the elevation cut-off angle for tracked GPS satellites. The receiver does not start automatically searching for a GPS satellite until it rises above the cut-off angle (when satellite position is known). Tracked satellites that fall below the cut-off angle are no longer tracked unless they are manually assigned (see the **ASSIGN** command on page 56).

In either case, satellites below the ECUTOFF angle are eliminated from the internal position and clock offset solution computations.

This command permits a negative cut-off angle; it could be used in these situations:

- The antenna is at a high altitude, and thus can look below the local horizon
- Satellites are visible below the horizon due to atmospheric refraction



Care must be taken when using **ECUTOFF** command because the signals from lower elevation satellites are traveling through more atmosphere and are therefore degraded. Use of satellites below 5 degrees is not recommended.



Use the **ELEVATIONCUTOFF** command (see page 114) to set the cut-off angle for any system.



For dual antenna receivers, this command applies to both the primary and secondary antennas.



A low elevation satellite is a satellite the receiver tracks just above the horizon. Generally, a satellite is considered low elevation if it is between 0 and 15 degrees above the horizon.

There is no difference between the data transmitted from a low elevation satellite and that transmitted from a higher elevation satellite. However, differences in the signal path of a low elevation satellite make their use less desirable. Low elevation satellite signals have more error due to the increased amount of atmosphere they must travel through. In addition, signals from low elevation satellites don't fit the assumption that a signal travels in air nearly the same as in a vacuum. As such, using low elevation satellites in the solution results in greater position inaccuracies.

The elevation cut-off angle is specified with **ECUTOFF** to ensure that noisy, low elevation satellite data below the cut-off is not used in computing a position. If post-processing data, it is still best to collect all data (even that below the cut-off angle). Experimenting with different cut-off angles can then be done to provide the best results. In cases where there are not enough satellites visible, a low elevation satellite may actually help in providing a useful solution.

Message ID: 50

Abbreviated ASCII Syntax:

ECUTOFF angle

Factory Default:

ECUTOFF 5.0

ASCII Example:

ECUTOFF 10.0

Field	Field Type	ASCII Value	Binary Value	Description	Format	Binary Bytes	Binary Offset
1	ECUTOFF header	-	-	Command header. See <i>Messages</i> on page 27 for more information.	-	H	0
2	angle	±90.0 degrees		Elevation cut-off angle relative to horizon	Float	4	H

2.28 ELEVATIONCUTOFF

Sets the elevation cut-off angle for tracked satellites

Platform: OEM719, OEM729, OEM7500, OEM7600, OEM7700, OEM7720, PwrPak7, SPAN CPT7, SMART7, SMART2

The **ELEVATIONCUTOFF** command is used to set the elevation cut-off angle for tracked satellites. The receiver does not start automatically searching for a satellite until it rises above the cut-off angle (when the satellite position is known). Tracked satellites that fall below the cut-off angle are no longer tracked unless they are manually assigned (refer to the **ASSIGN** command on page 56).

In either case, satellites below the elevation cut-off angle are eliminated from the internal position and clock offset solution computations.

This command permits a negative cut-off angle and can be used in the following situations:

- The antenna is at a high altitude and thus can look below the local horizon
- Satellites are visible below the horizon due to atmospheric refraction



Care must be taken when using **ELEVATIONCUTOFF** command because the signals from lower elevation satellites are traveling through more atmosphere and are therefore degraded. Use of satellites below 5 degrees is not recommended.



This command combines the following commands into one convenient command: **ECUTOFF**, **GLOECUTOFF**, **GALECUTOFF**, **QZSSECUTOFF**, **SBASECUTOFF**, **BDSECUTOFF** and **NAVICECUTOFF**.



For dual antenna receivers, this command applies to both the primary and secondary antennas.



A low elevation satellite is a satellite the receiver tracks just above the horizon. Generally, a satellite is considered low elevation if it is between 0 and 15 degrees above the horizon.

There is no difference between the data transmitted from a low elevation satellite and that transmitted from a higher elevation satellite. However, differences in the signal path of a low elevation satellite make their use less desirable. Low elevation satellite signals have more error due to the increased amount of atmosphere they must travel through. In addition, signals from low elevation satellites don't fit the assumption that a signal travels in air nearly the same as in a vacuum. As such, using low elevation satellites in the solution results in greater position inaccuracies.

The elevation cut-off angle is specified with the **ELEVATIONCUTOFF** command to ensure that noisy, low elevation satellite data below the cut-off is not used in computing a position. If post-processing data, it is still best to collect all data (even that below the cutoff angle). Experimenting with different cut-off angles can then be done to provide the best results. In cases where there are not enough satellites visible, a low elevation satellite may actually help in providing a useful solution.

Message ID: 1735**Abbreviated ASCII Syntax:**

```
ELEVATIONCUTOFF Constellation Angle [Reserved]
```

Factory default:

```
ELEVATIONCUTOFF ALL 5.0 0
```

ASCII Example:

```
ELEVATIONCUTOFF GPS 5
```

```
ELEVATIONCUTOFF ALL 5
```

Field	Field Type	ASCII Value	Binary Value	Description	Format	Binary Bytes	Binary Offset
1	ELEVATION CUTOFF header	-	-	Command header. See <i>Messages</i> on page 27 for more information.	-	H	0
2	Constellation	GPS	0	Sets the cut-off angle for GPS Constellation satellites only.	Enum	4	H
		GLONASS	1	Sets the cut-off angle for GLONASS constellation satellites only.			
		SBAS	2	Sets the cut-off angle for SBAS constellation satellites only.			
		GALILEO	5	Sets the cut-off angle for Galileo constellation satellites only.			
		BEIDOU	6	Sets the cut-off angle for BeiDou constellation satellites only.			
		QZSS	7	Sets the cut-off angle for QZSS constellation satellites only.			
		NAVIC	9	Sets the cut-off angle for NavIC constellation satellites only.			
		ALL	32	Sets the cut-off angle for all satellites regardless of the constellation.			

Field	Field Type	ASCII Value	Binary Value	Description	Format	Binary Bytes	Binary Offset
3	Angle	±90.0 degrees		Elevation cut-off angle relative to the horizon.	Float	4	H+4
4	Reserved	0		Reserved Field (optional)	Ulong	4	H+8

2.29 ETHCONFIG

Configures Ethernet physical layer

Platform: OEM729, OEM7600, OEM7700, OEM7720, PwrPak7, SPAN CPT7, SMART7-I, SMART7-SI

This command is used to configure the Ethernet physical layer.

Message ID: 1245

Abbreviated ASCII Syntax:

```
ETHCONFIG interface_name [speed] [duplex] [crossover] [power_mode]
```

Factory Default:

```
ETHCONFIG etha auto auto auto powerdown (OEM7 receiver cards)
```

```
ETHCONFIG etha auto auto auto auto (PwrPak7)
```

ASCII Example:

```
ETHCONFIG etha 100 full mdix normal
```

Field	Field Type	ASCII Value	Binary Value	Description	Format	Binary Bytes	Binary Offset
1	ETHCONFIG Header	-	-	Command header. See <i>Messages</i> on page 27 for more information.	-	H	0
2	interface_name	ETHA	2	Name of the Ethernet interface	Enum	4	H
3	speed	AUTO	1	Auto-negotiate speed (default) AUTO is the recommended value for the speed parameter. If setting speed to AUTO, duplex must be set to AUTO at the same time otherwise a "parameter 3 out of range" error occurs.	Enum	4	H+4
		10	2	Force 10BaseT			
		100	3	Force 100BaseT			

Field	Field Type	ASCII Value	Binary Value	Description	Format	Binary Bytes	Binary Offset
4	duplex	AUTO	1	Auto-negotiate duplex (default) If setting duplex to AUTO, speed must be set to AUTO at the same time otherwise a "parameter 3 out of range" error occurs.	Enum	4	H+8
		HALF	2	Force half duplex			
		FULL	3	Force full duplex			
5	crossover	AUTO	1	Auto-detect crossover (default)	Enum	4	H+12
		MDI	2	Force MDI (straight through)			
		MDIX	3	Force MDIX (crossover)			
6	power_mode	AUTO	1	Energy detect mode (default for PwrPak7)	Enum	4	H+16
		POWERDOWN	2	Soft power down mode (default for OEM7 receiver cards)			
		NORMAL	3	Normal mode			



The crossover parameter is ignored on OEM7 receivers, as the hardware automatically detects the cable connection and configures the interface for proper communication. For backwards compatibility, the crossover options are still accepted, but have no functional impact.

2.30 EVENTINCONTROL

Controls Event-In input triggers

Platform: OEM719, OEM729, OEM7500, OEM7600, OEM7700, OEM7720, PwrPak7, SPAN CPT7, SMART7, SMART2

This command controls up to four Event-In input triggers. Each input can be used as an event strobe.

When used as an event strobe, an accurate GPS time or position is applied to the rising or falling edge of the input event pulse (refer to the **MARK1TIME, MARK2TIME, MARK3TIME and MARK4TIME** log on page 518 or **MARKPOS, MARK2POS, MARK3POS and MARK4POS** log on page 515). Each input strobe is usually associated with a separate device, therefore different solution output lever arm offsets can be applied to each strobe. When used as an Event Input Trigger, it is possible to overwhelm the receiver with a very high rate of input events that impacts the performance of the receiver. For this reason, the receiver internally throttles the rate at which it responds to input events. The limit is 200 Hz.

Message ID: 1637

Abbreviated ASCII Syntax:

```
EVENTINCONTROL mark switch [polarity] [t_bias] [t_guard]
```

ASCII Example:

```
EVENTINCONTROL MARK1 ENABLE
```

Field	Field Type	ASCII Value	Binary Value	Description	Format	Binary Bytes	Binary Offset
1	EVENTINCONTROL header	-	-	Command header. See <i>Messages</i> on page 27 for more information.	-	H	0
2	mark	MARK1	0	Choose which Event-In Mark to change. This value must be specified. Note: MARK3 and MARK4 are available only on OEM7600, OEM7700 and OEM7720 receivers.	Enum	4	H
		MARK2	1				
		MARK3	2				
		MARK4	3				
3	switch	DISABLE	0	Disables Event Input	Enum	4	H+4
		EVENT	1	Enables Event Input			
		ENABLE	3	A synonym for the EVENT option (for compatibility with previous releases)			
4	polarity	NEGATIVE	0	Negative polarity (default)	Enum	4	H+8
		POSITIVE	1	Positive polarity			

Field	Field Type	ASCII Value	Binary Value	Description	Format	Binary Bytes	Binary Offset
5	t_bias	default: 0 minimum: -999,999,999 maximum: 999,999,999		A constant time bias in nanoseconds can be applied to each event pulse. Typically this is used to account for a transmission delay. This field is not used if the switch field is set to COUNT.	Long	4	H+12
6	t_guard	default: 4 minimum: 2 maximum: 3,599,999		The time guard specifies the minimum number of milliseconds between pulses. This is used to coarsely filter the input pulses. If Field 3 is COUNT, this field is not used.	Ulong	4	H+16

2.31 EVENTOUTCONTROL

Control Event-Out properties

Platform: OEM719, OEM729, OEM7500, OEM7600, OEM7700, OEM7720, PwrPak7, SPAN CPT7

This command configures up to seven Event-Out output strobes. The event strobes toggle between 3.3 V and 0 V. The pulse consists of two periods: one active period followed by a not active period. The start of the active period is synchronized with the top of the GNSS time second and the signal polarity determines whether the active level is 3.3 V or 0 V. The not active period immediately follows the active period and has the alternate voltage.



The outputs that are available vary according to the platform.



A 100 MHz clock is used internally to create these output signals. As a result, all period values are limited to 10 ns steps.



The EVENTOUT outputs cannot synchronize with GPS time until the receiver reaches FINESTEERING time status. As the receiver transitions to GPS time, there may be additional, unexpected pulses on the EVENTOUT signals.

Message ID: 1636

Abbreviated ASCII Syntax:

```
EVENTOUTCONTROL mark switch [polarity] [active_period] [non_active_period]
```

ASCII Example:

```
EVENTOUTCONTROL MARK3 ENABLE
```

Field	Field Type	ASCII Value	Binary Value	Description	Format	Binary Bytes	Binary Offset
1	EVENTOUT CONTROL header	-	-	Command header. See <i>Messages</i> on page 27 for more information.	-	H	0

Field	Field Type	ASCII Value	Binary Value	Description	Format	Binary Bytes	Binary Offset
2	mark	MARK1	0	Choose which Event-Out Mark to change. This value must be specified.	Enum	4	H
		MARK2	1				
		MARK3	2	Note: On OEM719 and OEM729 receivers, only MARK1 is available.			
		MARK4	3				
		MARK5	4	Note: On OEM7600, OEM7700 and OEM7720 receivers, only MARK1 through MARK4 are available.			
		MARK6	5				
		MARK7	6				
3	switch	DISABLE	0	Disables the Event output	Enum	4	H+4
		ENABLE	1	Enables the Event output			
4	polarity	NEGATIVE	0	Negative polarity (active = 0V) (default)	Enum	4	H+8
		POSITIVE	1	Positive polarity (active = 3.3V)			
5	active_period	default: 500,000,000 minimum: 10 maximum: 999,999,990		Active period of the Event Out signal in nanoseconds. 10 ns steps must be used. Note: If the value entered is not a multiple of 10, it will be rounded down to the nearest 10 ns.	Ulong	4	H+12
6	non_active_period	default: 500,000,000 minimum: 10 maximum: 999,999,990		Non-active period of the Event Out signal in nanoseconds. 10 ns steps must be used. Note: If the value entered is not a multiple of 10, it will be rounded down to the nearest 10 ns.	Ulong	4	H+16



The sum of the active period and inactive period should total 1,000,000,000 ns. If the total exceeds one full second, the active period duration will be as given and the inactive period will be the remainder of the second.

Alternately, the sum of the active and inactive periods may be less than 1,000,000,000 ns, but should divide evenly into 1,000,000,000 ns. For example, if the active period is 150,000,000 and the inactive period is 50,000,000, the sum of the periods is 200,000,000 ns which divides evenly into one full second.

If the sum is less than one full second and not an even multiple, the last active or inactive period is stretched or truncated to equal one full second.

A 100 MHz clock is used internally to create these output signals. As a result, all period values are limited to 10 ns steps.

2.32 FIX

Constrains to fixed height or position

Platform: OEM719, OEM729, OEM7500, OEM7600, OEM7700, OEM7720, PwrPak7, SPAN CPT7, SMART7, SMART2

This command is used to fix height or position to the input values. For various applications, fixing these values can assist in improving acquisition times and accuracy of position or corrections. For example, fixing the position is a requirement for differential base stations as it provides the reference position to base the differential corrections from.



1. It is strongly recommended that the FIX POSITION entered be accurate to within a few meters. This level of accuracy can be obtained from a receiver using single point positioning once 5 or 6 satellites are being tracked.
2. FIX POSITION should only be used for base station receivers. Applying FIX POSITION to a rover switches it from RTK mode to a fixed position mode. Applying FIX POSITION to the rover does not speed up ambiguity resolution.
3. Any setting other than FIX POSITION disables output of differential corrections unless the **MOVINGBASESTATION** command (see page 189) is set to ENABLE.
4. You can fix the position of the receiver using latitude, longitude and height in Mean Sea Level (MSL) or ellipsoidal parameters depending on the UNDULATION setting. The factory default for the **UNDULATION** command (see page 317) setting is EGM96, where the height entered in the **FIX** command is set as MSL height. If you change the UNDULATION setting to USER 0, the height entered in the **FIX** command is set as ellipsoidal height (refer to *Table 26: FIX Parameters* on the next page).

Error checking is performed on the entered fixed position by the integrity monitor. Depending on the result of this check, the position can be flagged with the following statuses.

- SOL_COMPUTED: The entered position has been confirmed by measurement.
- PENDING: Insufficient measurements are available to confirm the entered position.
- INTEGRITY_WARNING: First level of error when an incorrect position has been entered. The fixed position is off by approximately 25-50 meters.
- INVALID_FIX: Second level of error when an inaccurate position has been entered. The fixed position is off by a gross amount.



An incorrectly entered fixed position will be flagged either INTEGRITY_WARNING or INVALID_FIX. This will stop output of differential corrections or RTK measurements and can affect the clock steering and satellite signal search.

Message ID: 44

Abbreviated ASCII Syntax:

```
FIX type [param1 [param2 [param3]]]
```

Factory Default:

```
FIX none
```

ASCII Example:

FIX none

FIX HEIGHT 4.567

FIX position 51.116 -114.038 1065.0



In order to maximize the absolute accuracy of RTK rover positions, the base station coordinates must be fixed to their known position using the **FIX POSITION [lat][lon] [hgt]** command.

Field	Field Type	ASCII Value	Binary Value	Description	Format	Binary Bytes	Binary Offset
1	FIX header	-	-	Command header. See <i>Messages</i> on page 27 for more information.	-	H	0
2	type	See Table 27: <i>Fix Types</i> on the next page		Fix type	Enum	4	H
3	param1	See Table 26: <i>FIX Parameters</i> below		Parameter 1	Double	8	H + 4
4	param2			Parameter 2	Double	8	H + 12
5	param3			Parameter 3	Double	8	H + 20

Table 26: FIX Parameters

ASCII Type Name	Parameter 1	Parameter 2	Parameter 3
AUTO	Not used	Not used	Not used
HEIGHT	Default MSL height ¹ (-1000 to 20000000 m)	Not used	Not used
NONE	Not used	Not used	Not used
POSITION	Lat (-90 to 90 degrees) where a '-' sign denotes south and a '+' sign denotes north	Lon (-360 to 360 degrees) where a '-' sign denotes west and a '+' sign denotes east	Default MSL height ¹ (-1000 to 20000000 m)



For a discussion on height, refer to [An Introduction to GNSS](#) available on our website.

¹See also Note #4 above.

Table 27: Fix Types

ASCII Name	Binary Value	Description
NONE	0	Unfix. Clears any previous FIX commands
AUTO	1	Configures the receiver to fix the height at the last calculated value if the number of satellites available is insufficient for a 3-D solution. This provides a 2-D solution. Height calculation resumes when the number of satellites available allows a 3-D solution
HEIGHT	2	<p>Configures the receiver in 2-D mode with its height constrained to a given value. This command is used mainly in marine applications where height in relation to mean sea level may be considered to be approximately constant. The height entered using this command is referenced to the mean sea level, see the BESTPOS log on page 371 (is in meters). The receiver is capable of receiving and applying differential corrections from a base station while fix height is in effect. The fix height command overrides any previous FIX HEIGHT or FIX POSITION command.</p> <p>Note: This command only affects pseudorange corrections and solutions.</p>
POSITION	3	<p>Configures the receiver with its position fixed. This command is used when it is necessary to generate differential corrections.</p> <p>For both pseudorange and differential corrections, this command must be properly initialized before the receiver can operate as a GNSS base station. Once initialized, the receiver computes differential corrections for each satellite being tracked. The computed differential corrections can then be output to rover stations using the RTCMV3 differential corrections data log format. See the SMART7 Installation and Operation User Manual for information about using the receiver for differential applications.</p> <p>The values entered into the fix position command should reflect the precise position of the base station antenna phase center. Any errors in the fix position coordinates directly bias the corrections calculated by the base receiver.</p> <p>The receiver performs all internal computations based on WGS84 and the DATUM command (see page 100) is defaulted as such. The datum in which you choose to operate (by changing the DATUM command (see page 100)) is internally converted to and from WGS84. Therefore, all differential corrections are based on WGS84, regardless of your operating datum.</p> <p>The FIX POSITION command overrides any previous FIX HEIGHT or FIX POSITION command settings.</p>

2.33 FRESET

Clears selected data from NVM and reset

Platform: OEM719, OEM729, OEM7500, OEM7600, OEM7700, OEM7720, PwrPak7, SPAN CPT7, SMART7, SMART2

This command is used to clear data which is stored in non-volatile memory. Such data includes the almanac, ephemeris, and any user specific configurations. The commands, ephemeris, almanac, and L-Band related data, excluding the subscription information, can be cleared by using the STANDARD target. The receiver is forced to reset.



FRESET STANDARD (which is also the default) causes most commands, ephemeris, GNSS and almanac data previously saved to NVM to be erased.



The **FRESET STANDARD** command will erase all user settings. You should know your configuration (by requesting the **RXCONFIG** log on page 684) and be able to reconfigure the receiver before you send the **FRESET** command.

Message ID: 20

Abbreviated ASCII Syntax:

```
FRESET [target]
```

Input Example:

```
FRESET COMMAND
```

Field	Field Type	ASCII Value	Binary Value	Description	Format	Binary Bytes	Binary Offset
1	FRESET header	-	-	Command header. See <i>Messages</i> on page 27 for more information.	-	H	0
2	target	See <i>Table 28: FRESET Target</i> on the next page		What data is to be reset by the receiver (default = STANDARD)	Enum	4	H



If you are receiving no data or random data from your receiver, try the following before contacting NovAtel:

- Verify that the receiver is tracking satellites by logging the **TRACKSTAT** log (see page 786) and checking that the receiver is tracking at least four satellites.
- Check the integrity and connectivity of power, antenna and data cables
- Verify the baud rate settings of the receiver and terminal device (your PC, data logger or laptop)
- Switch COM ports
- Issue the **FRESET** command.

Table 28: FRESET Target

Binary	ASCII	Description
0	STANDARD	Resets commands (except CLOCKCALIBRATION and MODEL). Resets the stored ephemeris and almanac from all satellite systems. Resets all L-Band related data except for the subscription information. Does not reset the Ethernet settings or stored Profile configurations. (default)
1	COMMAND	Resets the stored commands (saved configuration)
2	GPSALMANAC	Resets the stored GPS almanac
3	GPSEPHEM	Resets the stored GPS ephemeris
4	GLOEPHEM	Resets the stored GLONASS ephemeris
5	MODEL	Resets the currently selected model
10	USERDATA	Resets the user data saved using the NVMUSERDATA command (see page 203)
11	CLKCALIBRATION	Resets the parameters entered using the CLOCKCALIBRATE command (see page 92)
20	SBASALMANAC	Resets the stored SBAS almanac
21	LAST_POSITION	Resets the position using the last stored position
31	GLOALMANAC	Resets the stored GLONASS almanac
39	GALFNAV_EPH	Resets the stored GALFNAV ephemeris
40	GALINAV_EPH	Resets the stored GALINAV ephemeris
45	GALFNAV_ALM	Resets the stored GALFNAV almanac

Binary	ASCII	Description
46	GALINAV_ALM	Resets the stored GALINAV almanac
52	PROFILEINFO	Resets the stored profile configurations
54	QZSSALMANAC	Resets the QZSS almanac
55	QZSSEPHEMERIS	Resets the QZSS ephemeris
57	BDSALMANAC	Resets the BeiDou almanac
58	BDSEPHEMERIS	Resets the BeiDou ephemeris
60	USER_ACCOUNTS	Resets the admin password to the default (the receiver PSN)
64	ETHERNET	Resets the stored Ethernet settings
85	SRTK_ SUBSCRIPTIONS	Resets the Secure RTK Subscription data stored on the rover receiver
87	NAVICEPHEMERIS	Resets the NavIC ephemeris
88	NAVICALMANAC	Resets the NavIC almanac
93	USER_DATUM	Resets the user datums (see the GEODETICDATUM command on page 137)
94	USER_DATUM_ TRANSFORMATION	Resets the user datums transformations (see the DATUMTRANSFORMATION command on page 102)

2.34 GALECUTOFF

Sets elevation cut-off angle for Galileo satellites

Platform: OEM719, OEM729, OEM7500, OEM7600, OEM7700, OEM7720, PwrPak7, SPAN CPT7, SMART7, SMART2

This command is used to set the elevation cut-off angle for tracked Galileo satellites. The receiver does not start automatically searching for a satellite until it rises above the cut-off angle (when satellite position is known). Tracked satellites that fall below the cut-off angle are no longer tracked unless they were manually assigned (see the **ASSIGN** command on page 56).

In either case, satellites below the GALECUTOFF angle are eliminated from the internal position and clock offset solution computations.

This command permits a negative cut-off angle and can be used in the following situations:

- The antenna is at a high altitude and thus look below the local horizon
- Satellites are visible below the horizon due to atmospheric refraction



Care must be taken when using **GALECUTOFF** because the signals from lower elevation satellites are traveling through more atmosphere and are therefore degraded. Use of satellites below 5 degrees is not recommended.



Use the **ELEVATIONCUTOFF** command (see page 114) to set the cut-off angle for any system.



For dual antenna receivers, this command applies to both the primary and secondary antennas.

Message ID: 1114

Abbreviated ASCII Syntax:

GALECUTOFF angle

Factory Default:

GALECUTOFF 5.0

ASCII Example:

GALECUTOFF 10.0

Field	Field Type	ASCII Value	Binary Value	Description	Format	Binary Bytes	Binary Offset
1	GALECUTOFF header	-	-	Command header. See <i>Messages</i> on page 27 for more information.	-	H	0

Field	Field Type	ASCII Value	Binary Value	Description	Format	Binary Bytes	Binary Offset
2	angle	±90.0 degrees		Elevation cut-off angle relative to horizon	Float	4	H

2.35 GENERATEALIGNCORRECTIONS

Configure ALIGN Master

Platform: OEM719, OEM729, OEM7500, OEM7600, OEM7700, OEM7720, PwrPak7, SPAN CPT7, SMART7

This command is used to configure the ALIGN Master and starts sending out ALIGN corrections through the specified port. This command is like sending the following commands to the Master, assuming the use of a serial port and default ALIGN corrections:

```
unlogall [port]
fix none
movingbasestation enable
interfacemode [port] novatel rtca
serialconfig [port] [baud] N 8 1 N ON
log [port] rtcaobs3 ontime [rate = 1/ obsregrate]
log [port] rtcarefext ontime [rate = 1/ refextregrate]
```

Message ID: 1349

Abbreviated ASCII Syntax:

```
GENERATEALIGNCORRECTIONS port [baud] [obsregrate] [refextregrate]
[interfacemode]
```

ASCII Example:

```
GENERATEALIGNCORRECTIONS COM2 230400 10 10
```

Field	Field Type	ASCII Value	Binary Value	Description	Format	Binary Bytes	Binary Offset
1	GENERATEALIGN CORRECTIONS header	-	-	Command header. See <i>Messages</i> on page 27 for more information.	-	H	0
2	port	See <i>Table 25: Communications Port Identifiers</i> on page 110		Port identifier (default = THISPORT)	Enum	4	H
3	baud	9600, 19200, 38400, 57600, 115200, 230400 or 460800		Communication baud rate (bps) (default = 9600)	Ulong	4	H+4
4	obsregrate	1, 2, 4, 5, 10, 20, 50 or 100		RTCAOBS3 data rate in Hz (default = 1)	Ulong	4	H+8
5	refextregrate	0, 1, 2, 4, 5, 10, 20, 50 or 100		RTCAREFEXT data rate in Hz (default = 1)	Ulong	4	H+12

Field	Field Type	ASCII Value	Binary Value	Description	Format	Binary Bytes	Binary Offset
6	interfacemode	RTCA	3	Correction interface mode (default = RTCA)	Enum	4	H+16
		NOVATELX	35				

2.36 GENERATEDIFFCORRECTIONS

Sends a preconfigured set of differential corrections

Platform: OEM719, OEM729, OEM7500, OEM7600, OEM7700, OEM7720, PwrPak7, SPAN CPT7, SMART7, SMART2

This command is used to configure the receiver to send a preconfigured set of differential pseudorange corrections.

Message ID: 1296

Abbreviated ASCII Syntax:

```
GENERATEDIFFCORRECTIONS mode port
```

ASCII Example:

```
GENERATEDIFFCORRECTIONS rtc com2
```

Preconfigured set of differential corrections sent when RTCM:

```
RTCM1 ontime 1
RTCM31 ontime 1
RTCM3 ontime 10
```

Preconfigured set of differential corrections sent when RTCA:

```
RTCA1 ontime 1
RTCAREF ontime 10
```

Field	Field Type	ASCII Value	Binary Value	Description	Format	Binary Bytes	Binary Offset
1	GENERATEDIFFCORRECTIONS header	-	-	Command header. See <i>Messages</i> on page 27 for more information.	-	H	0
2	mode	RTCM	2	Serial port interface mode identifier. See <i>Table 30: Serial Port Interface Modes</i> on page 151	Enum	4	H
		RTCA	3				
3	port	See <i>Table 51: COM Port Identifiers</i> on page 278		Port to configure	Enum	4	H+4

2.37 GENERATERTKCORRECTIONS

Sends a preconfigured set of RTK corrections

Platform: OEM719, OEM729, OEM7500, OEM7600, OEM7700, OEM7720, PwrPak7, SPAN CPT7, SMART7

This command is used to configure the receiver to send a preconfigured set of RTK (carrier phase) corrections.

Message ID: 1260

Abbreviated ASCII Syntax:

```
GENERATERTKCORRECTIONS mode port
```

ASCII Example:

```
GENERATERTKCORRECTIONS rtcmv3 com2
```

Preconfigured set of differential corrections sent when RTCM:

```
RTCM1819 ontime 1
RTCM3 ontime 10
RTCM22 ontime 10
RTCM23 ontime 60
RTCM24 ontime 60
```

Preconfigured set of differential corrections sent when RTCMV3:

```
RTCM1004 ontime 1
RTCM1012 ontime 1
RTCM1006 ontime 10
RTCM1008 ontime 10
RTCM1033 ontime 10
```

Preconfigured set of differential corrections sent when RTCA:

```
RTCAOBS2 ontime 1
RTCAREF ontime 10
```

Preconfigured set of differential corrections sent when CMR:

```
CMROBS ontime 1
CMRGLOBS ontime 1
CMRREF ontime 10
```

Preconfigured set of differential corrections sent when NOVATELX:

```
NOVATELXOBS ontime 1
```

Field	Field Type	ASCII Value	Binary Value	Description	Format	Binary Bytes	Binary Offset
1	GENERATERTK CORRECTIONS header	-	-	Command header. See <i>Messages</i> on page 27 for more information.	-	H	0
2	mode	RTCM	2	Serial port interface mode identifier. For more information, see <i>Table 30: Serial Port Interface Modes</i> on page 151	Enum	4	H
		RTCA	3				
		CMR	4				
		RTCMV3	14				
		NOVATELX	35				
3	port	See <i>Table 51: COM Port Identifiers</i> on page 278		Port to configure	Enum	4	H+4



For information about the RTCM, RTCA and CMR messages, refer to the official standards document for those messages.

2.38 GEODETICDATUM

Set user-defined datum parameters

Platform: OEM719, OEM729, OEM7500, OEM7600, OEM7700, OEM7720, PwrPak7, SPAN CPT7, SMART7, SMART2

Use this command to add or remove user-defined datums. These are used by the **OUTPUTDATUM** command (see page 204) to select an entry from the **DATUMTRANSFORMATIONS** log (see page 404). They also define the parameters to convert between geodetic and Cartesian coordinates.



The **OUTPUTDATUM** command (see page 204) must be sent for any user-defined datums to be output.

The receiver firmware includes a default set of datums. These default datums cannot be deleted, but can be overwritten with user-defined parameters. A default datum that has been overwritten can be reverted to the default parameters by deleting the datum. User-defined datums will persist a factory reset; all user-defined datums can be removed by sending **FRESET USER_DATUM** (see the **FRESET** command on page 127). Both the user-defined and default datums are reported by the **GEODETICDATUMS** log (see page 421).

Datum entries are indexed by name, which must be unique. The name "USER" is reserved for the **USEREXPDATUM** entry. "ECEF" is reserved as a generic Earth-Centered Earth-Fixed datum. "UNKNOWN" is also reserved.

The EPSG Geodetic Parameter Dataset (www.epsg-registry.org/) is a commonly-referenced database of coordinate reference systems and coordinate transformations. The EPSG code in this log is intended to correspond to the "GeodeticDatum" data type within that database. If you are using a custom datum, the EPSG code should be 0.

Message ID: 2295

Abbreviated ASCII Syntax:

```
GEODETICDATUM switch name epsg_code anchor semimajor_axis flattening
```

Factory Default:

```
GEODETICDATUM none
```

ASCII Example:

Save a new geodetic datum to NVM:

```
GEODETICDATUM save NAD83(MA11) 1118 EARTH_FIXED 6378137.0 298.257222101
```

Delete an existing geodetic datum from NVM:

```
GEODETICDATUM delete NAD83(MA11)
```

Field	Field Type	ASCII Value	Binary Value	Description	Format	Binary Bytes	Binary Offset
1	GEODETICDATUM header	-	-	Command header. See <i>Messages</i> on page 27 for more information.	-	H	0
2	switch	SAVE	1	Save the datum.	Enum	4	H
		DELETE	2	Delete the datum.			
3	name			Name of the datum.	Char [32]	variable	H+4
4	epsg_code			The EPSG code.	Ulong	4	variable
5	anchor	See <i>Table 29: Datum Anchors</i> below		The datum type.	Enum	4	variable
6	semimajor_axis	6300000.000 – 6400000.000		Semi-major axis of the datum's ellipsoid (meters)	Double	8	variable
7	flattening	290.000 – 305.000		Inverse flattening of the datum's ellipsoid (unitless)	Double	8	variable

Table 29: Datum Anchors

Binary	ASCII	Description
0	UNKNOWN	The anchor is unknown.
1	EARTH_FIXED	The datum is not anchored to a specific tectonic plate (e.g., ITRF2005, WGS84).
2	PLATE_FIXED	The datum is anchored to a tectonic plate (e.g., NAD83, ETRF89).

2.39 GGAQUALITY

Customizes the GPGGA GPS quality indicator

Platform: OEM719, OEM729, OEM7500, OEM7600, OEM7700, OEM7720, PwrPak7, SPAN CPT7, SMART7, SMART2

This command is used to customize the NMEA GPGGA GPS quality indicator. See also the **GPGGA** log on page 444.



This command also changes the GPS quality indicator in the NMEA2000 CAN logs.

Message ID: 691

Abbreviated ASCII Syntax:

```
GGAQUALITY #entries pos_type quality
```

Input Example 1:

```
GGAQUALITY 1 waas 2
```

Makes the WAAS solution type show 2 as the quality indicator.

Input Example 2:

```
GGAQUALITY 2 waas 2 NARROW_FLOAT 3
```

Makes the WAAS solution type show 2 and the NARROW_FLOAT solution type show 3, as their quality indicators.

Input Example 3:

```
GGAQUALITY 0
```

Sets all the quality indicators back to the default.



Some solution types, see *Table 66: Position or Velocity Type* on page 375, share a quality indicator. For example, converged PPP and NARROW_FLOAT all share an indicator of 5. This command can be used to customize an application to have unique indicators for each solution type. Sets all the quality indicators back to the default. Refer to *Table 85: GPS Quality Indicators* on page 445.

Field	Field Type	ASCII Value	Binary Value	Description	Format	Binary Bytes	Binary Offset
1	GGAQUALITY header	-	-	Command header. See <i>Messages</i> on page 27 for more information.	-	H	0
2	#entries	0-20		The number of position types that are being remapped (20 max)	Ulong	4	H

Field	Field Type	ASCII Value	Binary Value	Description	Format	Binary Bytes	Binary Offset
3	pos_type	See Table 66: <i>Position or Velocity Type</i> on page 375		The position type that is being remapped	Enum	4	H+4
4	quality	See Table 85: <i>GPS Quality Indicators</i> on page 445		The remapped quality indicator value that will appear in the GPGGA log for this position type	Ulong	4	H+8
...	Next solution type and quality indicator set, if applicable				Variable		

2.40 GLIDEINITIALIZATIONPERIOD

Configures the GLIDE initialization period

Platform: OEM719, OEM729, OEM7500, OEM7600, OEM7700, OEM7720, PwrPak7, SPAN CPT7, SMART7, SMART2

This command sets the initialization period for Relative PDP (GLIDE) when pseudorange measurements are used more heavily. During the initialization period, the PDP output position is not as smooth as during full GLIDE operation, but it helps to get better absolute accuracy at the start. The longer this period is, the better the absolute accuracy that can be attained. The maximum period that can be set through **GLIDEINITIALIZATIONPERIOD** is 1200 seconds.

Message ID: 1760

Abbreviated ASCII Syntax:

```
GLIDEINITIALIZATIONPERIOD initialization
```

Factory Default:

```
GLIDEINITIALIZATIONPERIOD 300
```

ASCII Example:

```
GLIDEINITIALIZATIONPERIOD 100
```

Field	Field Type	ASCII Value	Binary Value	Description	Binary Format	Binary Bytes	Binary Offset
1	GLIDEINITIALIZATION PERIOD header	-	-	Command header. See <i>Messages</i> on page 27 for more information.	-	H	0
2	initialization	0 -1200 s		Initialization period for GLIDE in seconds	Double	8	H

2.41 GLOECUTOFF

Sets GLONASS satellite elevation cut-off

Platform: OEM719, OEM729, OEM7500, OEM7600, OEM7700, OEM7720, PwrPak7, SPAN CPT7, SMART7, SMART2

This command is used to set the elevation cut-off angle for tracked GLONASS satellites. The receiver does not start automatically searching for a satellite until it rises above the cut-off angle (when satellite position is known). Tracked satellites that fall below the cut-off angle are no longer tracked unless they were manually assigned (see the **ASSIGN** command on page 56).

In either case, satellites below the GLOECUTOFF angle are eliminated from the internal position and clock offset solution computations.

This command permits a negative cut-off angle and can be used in the following situations:

- The antenna is at a high altitude and can look below the local horizon
- Satellites are visible below the horizon due to atmospheric refraction
- However, for GLONASS it is not recommended to use negative values because a receiver should not track both antipodal satellites that are broadcasting on the same frequency.



Care must be taken when using **GLOECUTOFF** because the signals from lower elevation satellites are traveling through more atmosphere and are therefore degraded. Use of satellites below 5 degrees is not recommended.



Use the **ELEVATIONCUTOFF** command (see page 114) to set the cut-off angle for any system.



For dual antenna receivers, this command applies to both the primary and secondary antennas.

Message ID: 735

Abbreviated ASCII Syntax:

GLOECUTOFF angle

Factory Default:

GLOECUTOFF 5.0

ASCII Example:

GLOECUTOFF 0

Field	Field Type	ASCII Value	Binary Value	Description	Format	Binary Bytes	Binary Offset
1	GLOECUTOFF header	-	-	Command header. See <i>Messages</i> on page 27 for more information.	-	H	0
2	angle	±90.0 degrees		Elevation cut-off angle relative to horizon	Float	4	H

2.42 HDTOUTTHRESHOLD

Controls GPHDT log output

Platform: OEM719, OEM729, OEM7500, OEM7600, OEM7700, OEM7720, PwrPak7, SPAN CPT7, SMART7

This command is used to control the output of the NMEA **GPHDT** log (see page 459). It sets a heading standard deviation threshold. Only heading information with a standard deviation less than this threshold can be output into a GPHDT message.

Message ID: 1062

Abbreviated ASCII Syntax:

```
HDTOUTTHRESHOLD thresh
```

Factory Default:

```
HDTOUTTHRESHOLD 2.0
```

ASCII Example:

```
HDTOUTTHRESHOLD 12.0
```

Field	Field Type	ASCII Value	Binary Value	Description	Format	Binary Bytes	Binary Offset
1	HDTOUTTHRESHOLD header	-	-	Command header. See <i>Messages</i> on page 27 for more information.	-	H	0
2	thresh	0.0 - 180.0		Heading standard deviation threshold (degrees)	Float	4	H

2.43 HEADINGOFFSET

Adds heading and pitch offset values

Platform: OEM719, OEM729, OEM7500, OEM7600, OEM7700, OEM7720, PwrPak7, SPAN CPT7, SMART7

This command is used to add an offset in the heading and pitch values of the **HEADING2** log (see page 469) and **GPHDT** log (see page 459).

Message ID: 1082

Abbreviated ASCII Syntax:

```
HEADINGOFFSET headingoffsetindeg [pitchoffsetindeg]
```

Factory Default:

```
HEADINGOFFSET 0 0
```

ASCII Example:

```
HEADINGOFFSET 2 -1
```

Field	Field Type	ASCII Value	Binary Value	Description	Format	Binary Bytes	Binary Offset
1	HEADINGOFFSET header	-	-	Command header. See <i>Messages</i> on page 27 for more information.	-	H	0
2	headingoffsetindeg	-180.0 - 180.0		Offset added to heading output (degrees). Default=0	Float	4	H
3	pitchoffsetindeg	-90.0 - 90.0		Offset added to pitch output (degrees). Default=0	Float	4	H+4

2.44 ICOMCONFIG

Configures IP virtual COM port

Platform: OEM729, OEM7600, OEM7700, OEM7720, PwrPak7, SPAN CPT7, SMART7-I, SMART7-SI

This command is used for Ethernet set up and to configure the transport/application layer of the configuration.



Access to the ICOM ports can be restricted by turning on ICOM security using the **IPSERVICE** command (see page 156).

Message ID: 1248

Abbreviated ASCII Syntax:

```
ICOMCONFIG [port] protocol [endpoint [bindinterface]]
```

Factory Default:

```
ICOMCONFIG ICOM1 TCP :3001
ICOMCONFIG ICOM2 TCP :3002
ICOMCONFIG ICOM3 TCP :3003
ICOMCONFIG ICOM4 TCP :3004
ICOMCONFIG ICOM5 TCP :3005
ICOMCONFIG ICOM6 TCP :3006
ICOMCONFIG ICOM7 TCP :3007
```

ASCII Example:

```
ICOMCONFIG ICOM1 TCP :2000 All
```



Due to security concerns, configuring and enabling ICOM ports should only be done to receivers on a closed system, that is, board-to-board. NovAtel is not liable for any security breaches that may occur if not used on a closed system.

Field	Field Type	ASCII Value	Binary Value	Data Description	Format	Binary Bytes	Binary Offset
1	ICOMCONFIG Header	-	-	Command header. See <i>Messages</i> on page 27 for more information.	-	H	0

Field	Field Type	ASCII Value	Binary Value	Data Description	Format	Binary Bytes	Binary Offset
2	port	THISPORT	6	Name of the port (default = THISPORT).	Enum	4	H
		ICOM1	23				
		ICOM2	24				
		ICOM3	25				
		ICOM4	29				
		ICOM5	46				
		ICOM6	47				
		ICOM7	48				
3	protocol	DISABLED	1	Will disable the service	Enum	4	H+4
		TCP	2	Use Raw TCP			
		UDP	3	Use Raw UDP			
4	endpoint	Host:Port For example: 10.0.3.1:8000 mybase.com:3000		Endpoint to wait on, or to connect to where host is a host name or IP address and port is the TCP/UDP port number. If host is blank, act as a server.	String [80]	variable ¹	H+8
5	bindInterface	ALL (default)	1	Not supported. Set to ALL for future compatibility.	Enum	4	H+88

¹In the binary case, each string field needs to be NULL terminated and additional bytes of padding added to maintain 4-byte alignment, up to the maximum defined by the string size. The next defined field starts immediately at the next 4-byte alignment following the NULL.

2.45 INTERFACEMODE

Sets receive or transmit modes for ports

Platform: OEM719, OEM729, OEM7500, OEM7600, OEM7700, OEM7720, PwrPak7, SPAN CPT7, SMART7, SMART2

This command is used to specify what type of data a particular port on the receiver can transmit and receive. The receive type tells the receiver what type of data to accept on the specified port. The transmit type tells the receiver what kind of data it can generate. For example, to accept RTCMV3 differential corrections, set the receive type on the port to RTCMV3.

It is also possible to disable or enable the generation or transmission of command responses for a particular port. Disabling of responses is important for applications where data is required in a specific form and the introduction of extra bytes may cause problems, i.e., RTCA, RTCM, RTCMV3 or CMR. Disabling a port prompt is also useful when the port is connected to a modem or other device that responds with data the RECEIVER does not recognize.



For applications running in specific interface modes, see *Table 30: Serial Port Interface Modes* on page 151, please set the appropriate interface modes before sending or receiving corrections. It is important that the port interface mode matches the data being received on that port. Mismatches between the interface mode and received data can result in CPU overloads.

When INTERFACEMODE port NONE NONE OFF is set, the specified port is disabled from interpreting any input or output data. Therefore, no commands or differential corrections are decoded by the specified port. When GENERIC is set for a port, it is also disabled but data can be passed through the disabled port and be output from an alternative port using the pass-through logs PASSCOM, PASSAUX and PASSUSB. See *PASSCOM*, *PASSAUX*, *PASSUSB*, *PASSETH1*, *PASSICOM*, *PASSNCOM* on page 552 for details on these logs along with the Operation chapter in the [OEM7 Installation and Operation User Manual](#) for information about pass-through logging. See also the **SERIALCONFIG** command on page 276. If you intend to use the **SERIALCONFIG** command (see page 276), ensure you do so before the **INTERFACEMODE** command on each port. The **SERIALCONFIG** command (see page 276) can remove the **INTERFACEMODE** command setting if the baud rate is changed after the interface mode is set. You should also turn break detection off using the **SERIALCONFIG** command (see page 276) to stop the port from resetting because it is interpreting incoming bits as a break command. If such a reset happens, the Interface mode will be set back to the default NOVATEL mode for both input and output.

2.45.1 SPAN Systems

The INTERFACEMODE of the receiver is also configured for the serial port dedicated to the IMU. This mode changes automatically upon sending a **CONNECTIMU** command (see page 812) and the change is reflected when logging this command. This is normal operation.



When the **CONNECTIMU** command (see page 812) is used to configure the IMU connected to the receiver, the correct interface mode for the IMU port is automatically set. The IMU port should not be altered using the **INTERFACEMODE** command in normal operation. Doing so may result in the loss of IMU communication.

Message ID: 3

Abbreviated ASCII Syntax:

```
INTERFACEMODE [port] rxtype txtype [responses]
```

Factory Default:

```
INTERFACEMODE COM1 NOVATEL NOVATEL ON
INTERFACEMODE COM2 NOVATEL NOVATEL ON
INTERFACEMODE COM3 NOVATEL NOVATEL ON
INTERFACEMODE AUX NOVATEL NOVATEL ON
INTERFACEMODE USB1 NOVATEL NOVATEL ON
INTERFACEMODE USB2 NOVATEL NOVATEL ON
INTERFACEMODE USB3 NOVATEL NOVATEL ON
INTERFACEMODE ICOM1 NOVATEL NOVATEL ON
INTERFACEMODE ICOM2 NOVATEL NOVATEL ON
INTERFACEMODE ICOM3 NOVATEL NOVATEL ON
INTERFACEMODE ICOM4 NOVATEL NOVATEL ON
INTERFACEMODE ICOM5 NOVATEL NOVATEL ON
INTERFACEMODE ICOM6 NOVATEL NOVATEL ON
INTERFACEMODE ICOM7 NOVATEL NOVATEL ON
INTERFACEMODE NCOM1 RTCMV3 NONE OFF
INTERFACEMODE NCOM2 RTCMV3 NONE OFF
INTERFACEMODE NCOM3 RTCMV3 NONE OFF
INTERFACEMODE CCOM1 NOVATELBINARY NOVATELBINARY ON
INTERFACEMODE CCOM2 NOVATELBINARY NOVATELBINARY ON
INTERFACEMODE CCOM3 AUTO NOVATEL OFF
INTERFACEMODE CCOM4 AUTO NOVATEL OFF
INTERFACEMODE CCOM5 AUTO NOVATEL OFF
INTERFACEMODE CCOM6 AUTO NOVATEL OFF
INTERFACEMODE SCOM1 NOVATEL NOVATEL ON
INTERFACEMODE SCOM2 NOVATEL NOVATEL ON
INTERFACEMODE SCOM3 NOVATEL NOVATEL ON
INTERFACEMODE SCOM4 NOVATEL NOVATEL ON
```

ASCII Example 1:

```
INTERFACEMODE COM1 RTCMV3 NOVATEL ON
```

ASCII Example 2:

```
INTERFACEMODE COM2 MRTCA NONE
```



Are NovAtel receivers compatible with others on the market?

All GNSS receivers output two solutions: position and time. The manner in which they output them makes each receiver unique. Most geodetic and survey grade receivers output the position in electronic form (typically RS-232), which makes them compatible with most computers and data loggers. All NovAtel receivers have this ability. However, each manufacturer has a unique way of formatting the messages. A NovAtel receiver is not directly compatible with a Trimble or Ashtech receiver (which are also incompatible with each other) unless everyone uses a standard data format.

However, there are several standard data formats available. For position and navigation output there is the NMEA format. Real-time differential corrections use RTCM or RTCA format. For receiver code and phase data RINEX format is often used. NovAtel and all other major manufacturers support these formats and can work together using them. The NovAtel format measurement logs can be converted to RINEX using the utilities provided in NovAtel Connect.

Field	Field Type	ASCII Value	Binary Value	Description	Format	Binary Bytes	Binary Offset
1	INTERFACEMODE header	-	-	Command header. See <i>Messages</i> on page 27 for more information.	-	H	0
2	port	See Table 25: <i>Communications Port Identifiers</i> on page 110		Serial port identifier (default = THISPORT) Note: On the SMART2, the INTERFACEMODE command cannot be used with CCOM ports.	Enum	4	H
3	rxtype	See Table 30: <i>Serial Port Interface Modes</i> on the next page		Receive interface mode	Enum	4	H+4
4	txtype	See Table 30: <i>Serial Port Interface Modes</i> on the next page		Transmit interface mode	Enum	4	H+8
5	responses	OFF	0	Turn response generation off	Enum	4	H+12
		ON	1	Turn response generation on (default)			

Table 30: Serial Port Interface Modes

Binary Value	ASCII Value	Description
0	NONE	The port accepts/generates nothing. The port is disabled.
1	NOVATEL	The port accepts/generates NovAtel commands and logs.
2	RTCM	The port accepts/generates RTCM corrections.
3	RTCA	The port accepts/generates RTCA corrections.
4	CMR	The port accepts/generates CMR corrections.
5	Reserved	
6	Reserved	
7	IMU	This port supports communication with a NovAtel supported IMU.
8	RTCMNOCR	When RTCMNOCR is used as the <i>txtype</i> , the port generates RTCM corrections without the CR/LF appended. When RTCMNOCR is used as the <i>rxtype</i> , the port accepts RTCM corrections with or without the CR/LF appended.
9	Reserved	
10	TCOM1	<p>INTERFACEMODE tunnel modes. To configure a full duplex tunnel, configure the baud rate on each port. Once a tunnel is established, the baud rate does not change. Special characters, such as a BREAK condition, do not route across the tunnel transparently and the serial port is altered, see the SERIALCONFIG command on page 276. Only serial ports may be in a tunnel configuration: COM1, COM2, COM3 or AUX may be used.</p> <p>For example, configure a tunnel at 115200 bps between COM1 and AUX:</p> <pre>SERIALCONFIG AUX 115200 SERIALCONFIG COM1 115200 INTERFACEMODE AUX TCOM1 NONE OFF INTERFACEMODE COM1 TAUX NONE OFF</pre> <p>The tunnel is fully configured to receive/transmit at a baud rate of 115200 bps.</p>
11	TCOM2	
12	TCOM3	
13	TAUX ¹	
14	RTCMV3	The port accepts/generates RTCM Version 3.0 corrections.

¹Only available on specific models.

Binary Value	ASCII Value	Description
15	NOVATELBINARY	The port only accepts/generates binary messages. If an ASCII command is entered when the mode is set to binary only, the command is ignored. Only properly formatted binary messages are responded to and the response is a binary message.
16-17	Reserved	
18	GENERIC	The port accepts/generates nothing. The SEND command (see page 274) from another port generate data on this port. Any incoming data on this port can be seen with PASSCOM logs on another port, see PASSCOM, PASSAUX, PASSUSB, PASSETH1, PASSICOM, PASSNCOM log on page 552.
19	IMARIMU	This port supports communication with an iMAR IMU.
20	MRTCA	The port accepts/generates Modified Radio Technical Commission for Aeronautics (MRTCA) corrections.
21-22	Reserved	
23	KVHIMU	This port supports communication with a KVH CG5100 IMU.
24-26	Reserved	
27	AUTO	For auto-detecting different RTK correction formats and incoming baud rate (over serial ports). The change of baud rate will not appear when SERIALCONFIG is logged as this shows the saved baud rate for that port.
28-34	Reserved	
35	NOVATELX	The port accepts/generates NOVATELX corrections.
36-40	Reserved	
41	KVH1750IMU	This port supports communication with a KVH 17xx series IMU.
42-45	Reserved	
46	TCCOM1	CCOM1 Tunnel
47	TCCOM2	CCOM2 Tunnel
48	TCCOM3	CCOM3 Tunnel
49	NOVATELMINBINARY	NovAtel binary message with a minimal header. Only available for CCOM ports.
50	TCCOM4	CCOM4 Tunnel
51	TCCOM5	CCOM5 Tunnel

Binary Value	ASCII Value	Description
52	TCCOM6	CCOM6 Tunnel
53-57	Reserved	
60	TSCOM1	SCOM1 Tunnel
61	TSCOM2	SCOM2 Tunnel
62	TSCOM3	SCOM3 Tunnel
63	TSCOM4	SCOM4 Tunnel
64	LUA	Lua stdin/stdout/stderr. Use the LUA PROMPT command to set this Interface Mode.

2.46 IPCONFIG

Configures network IP settings

Platform: OEM729, OEM7600, OEM7700, OEM7720, PwrPak7, SPAN CPT7, SMART7-I, SMART7-SI

This command is used to configure static/dynamic TCP/IP properties for the Ethernet connection.



In addition to configuring an IP address and netmask for the interface, this command also includes a gateway address.

Message ID: 1243

Abbreviated ASCII Syntax:

```
IPCONFIG [interface_name] address_mode [IP_address [netmask [gateway]]]
```

Factory Default:

```
IPCONFIG ETHA DHCP
```

ASCII Examples:

```
IPCONFIG ETHA STATIC 192.168.74.10 255.255.255.0 192.168.74.1
```

Field	Field Type	ASCII Value	Binary Value	Description	Format	Binary Bytes	Binary Offset
1	IPCONFIG Header	-	-	Command header. See <i>Messages</i> on page 27 for more information.	-	H	0
2	interface name	ETHA	2	Name of the Ethernet interface (default = ETHA)	Enum	4	H
3	address mode	DHCP	1	Use Dynamic IP address	Enum	4	H+4
		STATIC	2	Use Static IP address			
4	IP address	ddd.ddd.ddd.ddd (For example: 10.0.0.2)		IP Address-decimal dot notation	String [16]	variable ₁	H+8
5	netmask	ddd.ddd.ddd.ddd (For example: 255.255.255.0)		Netmask-decimal dot notation	String [16]	variable ₁	H+24

¹In the binary case, each string field needs to be NULL terminated and additional bytes of padding added to maintain 4-byte alignment, up to the maximum defined by the string size. The next defined field starts immediately at the next 4-byte alignment following the NULL.

Field	Field Type	ASCII Value	Binary Value	Description	Format	Binary Bytes	Binary Offset
6	gateway	ddd.ddd.ddd.ddd (For example: 10.0.0.1)		Gateway-decimal dot notation	String [16]	variable 1	H+40

2.47 IPSERVICE

Configure availability of networks ports/services

Platform: OEM729, OEM7600, OEM7700, OEM7720, PwrPak7, SPAN CPT7, SMART7-I, SMART7-SI

Use the **IPSERVICE** command to configure the availability of specific network ports/services. When disabled, the service does not accept incoming connections.



On most OEM7 receivers, the FTP Server is disabled by default. The exception is the PwrPak7 which has FTP enabled by default.



We have found two problems in the Microsoft® FTP clients contained within the Internet Explorer® and Edge browsers which make them unsuitable for retrieving files from a NovAtel receiver. When using a Windows® computer to transfer files off a NovAtel receiver, we suggest using a 3rd party FTP client.

Message ID: 1575

Abbreviated ASCII Syntax:

```
IPSERVICE IPService switch
```

Factory Default:

```
IPSERVICE WEB_SERVER DISABLE (OEM719 and OEM7500)
```

```
IPSERVICE WEB_SERVER ENABLE (OEM729, OEM7600 OEM7700 and OEM7720)
```

```
IPSERVICE SECURE_ICOM DISABLE
```

ASCII Example:

```
IPSERVICE FTP_SERVER ENABLE
```

Field	Field Type	ASCII Value	Binary Value	Description	Format	Binary Bytes	Binary Offset
1	IPSERVICE header	-	-	Command header. See <i>Messages</i> on page 27 for more information.	-	H	0

Field	Field Type	ASCII Value	Binary Value	Description	Format	Binary Bytes	Binary Offset
2	ipservice	NO_PORT	0	No port	Enum	4	H
		FTP_SERVER	1	FTP server port. For most OEM7 receivers the default = DISABLE. For the PwrPak7 the default = ENABLE.			
		WEB_SERVER	2	Web server port For most OEM7 receivers the default = ENABLE. For the OEM7500 and OEM719 the default = DISABLE.			
		SECURE_ICOM	3	Enables or disables security on ICOM ports. When security is enabled, a login is required as part of the connection process (see the LOGIN command on page 180). Default = DISABLE Note: Security in this sense means users must supply a name and password before being allowed to enter commands on the ICOM ports. It does not mean there is data encryption			
3	switch	DISABLE	0	Disable the IP service specified.	Enum	4	H+4
		ENABLE	1	Enable the IP service specified.			

2.48 ITBANDPASSCONFIG

Enable and configure bandpass filter on receiver

Platform: OEM719, OEM729, OEM7500, OEM7600, OEM7700, OEM7720, PwrPak7, SPAN CPT7, SMART7

Use this command to apply a bandpass filter at a certain frequency to mitigate interference in the pass band of GNSS signals. The **ITBANDPASSBANK** log (see page 487) provides information on the allowable configuration settings for each frequency band. The bandpass filter is symmetrical in nature, which means that specifying one cutoff frequency will apply a cutoff on both the low side and high side of the signal's center frequency. Only one filter can be applied for each signal.



On OEM7720, PwrPak7D, PwrPak7D-E1, PwrPak7D-E2 and SPAN CPT7 receivers, any filter enabled for GPS L2 or GLONASS L2 on the secondary antenna will be applied to both GPS L2 and GLONASS L2. For this reason, care must be taken to avoid attenuating the signals with a bandpass filter that is too narrow in bandwidth. The recommended maximum lower cutoff frequency is 1221 MHz. The recommended minimum upper cutoff frequency is 1254 MHz.

Message ID: 1999

Abbreviated ASCII Syntax:

```
ITBANDPASSCONFIG frequency switch [cutofffrequency]
```

ASCII Example:

```
ITBANDPASSCONFIG gpsl5 enable 1165.975
```

Field	Field Type	ASCII Value	Binary Value	Description	Format	Binary Bytes	Binary Offset
1	ITBANDPASS CONFIG header	-	-	Command header. See <i>Messages</i> on page 27 for more information.	-	H	0
2	frequency	See <i>Table 37: Frequency Types</i> on page 168		Set the frequency band on which to apply the filter	Enum	4	H
3	switch	DISABLE	0	Disable filter	Enum	4	H+4
		ENABLE	1	Enable filter			

Field	Field Type	ASCII Value	Binary Value	Description	Format	Binary Bytes	Binary Offset
4	cutofffrequency			Cut off frequency for band pass filter (MHz). (default = 0) Refer to ITBANDPASSBANK log (see page 487) for the allowable values.	Float	4	H+8

2.49 ITDETECTCONFIG

Enable interference detection on receiver

Platform: OEM719, OEM729, OEM7500, OEM7600, OEM7700, OEM7720, PwrPak7, SPAN CPT7, SMART7

This command is used to enable or disable interference detection on the receiver. It is applicable to both Spectral Analysis Detection and Statistical Analysis Detection at the same time. Detection can be enabled on all RF paths, only one RF path (L1, L2, or L5), or no RF paths. By default, only the RF paths connecting to the first antenna are enabled.

Message ID: 2143

Abbreviated ASCII Syntax:

```
ITDETECTCONFIG RFPATH [reserved1] [reserved2] [reserved3]
```

Factory Default:

```
ITDETECTCONFIG all
```

ASCII Example:

```
ITDETECTCONFIG L1
```

```
ITDETECTCONFIG none
```

Field	Field Type	ASCII Value	Binary Value	Description	Format	Binary Bytes	Binary Offset
1	ITDETECTCONFIG header	-	-	Command header. See <i>Messages</i> on page 27 for more information.	-	H	0
2	RFPATH	See Table 31: <i>RF Path Selection</i> below		RF path selected for detection. By default, all paths are turned on. The receiver will cycle through all active paths.	Enum	4	H
3	reserved1	0		Reserved parameter	Ulong	4	H+4
4	reserved2	0		Reserved parameter	Ulong	4	H+8
5	reserved3	0		Reserved parameter	Ulong	4	H+12

Table 31: RF Path Selection

ASCII Value	Binary Value	Description
NONE	0	Turn off detection on all paths
ALL	1	Turn on detection on all paths (cycle through all active paths)

ASCII Value	Binary Value	Description
L1	2	Turn on detection only on L1 path
L2	3	Turn on detection only on L2 path
L5	4	Turn on detection only on L5 path

2.50 ITFRONTENDMODE

Configure the front end mode settings

Platform: OEM719, OEM729, OEM7500, OEM7600, OEM7700, OEM7720, PwrPak7, SPAN CPT7, SMART7

Use this command to configure the front end mode for the L1, L2 and L5 RF paths to use the default third-order CIC mode or HDR (High Dynamic Range) mode. The HDR mode is used in an interference environment to obtain best interference rejection in general. However, the power consumption will increase in this mode.

Message ID: 2039

Abbreviated ASCII Syntax:

```
ITFRONTENDMODE frequency mode
```

Factory Default

```
ITFRONTENDMODE L1 cic3
ITFRONTENDMODE L2 cic3
ITFRONTENDMODE LBAND cic3
ITFRONTENDMODE L5 cic3
```

ASCII Example:

```
ITFRONTENDMODE L1 hdr
```



On the OEM7500, the default mode for all frequency bands is HDR.

Field	Field Type	ASCII Value	Binary Value	Description	Format	Binary Bytes	Binary Offset
1	ITFRONTENDMODE header	-	-	Command header. See <i>Messages</i> on page 27 for more information.	-	H	0
2	frequency	See <i>Table 32: Frequency Bands</i> on the next page		Set the frequency band for adjustment	Enum	4	H
3	mode	See <i>Table 33: Mode</i> on the next page		Select the desired mode	Enum	4	H+4

Table 32: Frequency Bands

Binary Value	ASCII Value	Description
2	L1	Selects the L1 frequency
3	L2	Selects the L2 frequency
4	LBAND	Selects the L-Band frequency
5	L5	Selects the L5 frequency

Table 33: Mode

Binary Value	ASCII Value	Description
0	CIC3	3rd order CIC (CIC3) mode (default)
1	HDR	High Dynamic Range (HDR) mode

2.51 ITPROGFILTCONFIG

Enable and configure filtering on the receiver

Platform: OEM719, OEM729, OEM7500, OEM7600, OEM7700, OEM7720, PwrPak7, SPAN CPT7, SMART7

Use this command to set the programmable filter to be either a notch filter or a bandpass filter to mitigate interference in the pass band of GNSS signals. The notch filter is used to attenuate a very narrow band of frequencies (specified by the notch width) around the configured center frequency.

The bandpass filter is symmetrical in nature, which means that specifying one cutoff frequency will apply a cutoff on both the low side and high side of the spectrum center frequency.

The **ITPROGFILTBANK** log (see page 495) provides information on the allowable configuration settings for the programmable filter (i.e. the allowable settings for the notch filter and bandpass filter) for each frequency band. Only one filter can be applied for each frequency.

Message ID: 2000

Abbreviated ASCII Syntax:

```
ITPROGFILTCONFIG frequency filterid switch [filtermode] [cutofffreq]
[notchwidth]
```

ASCII Example:

```
ITPROGFILTCONFIG gps11 pf0 enable notchfilter 1580 1
```

Field	Field Type	ASCII Value	Binary Value	Description	Format	Binary Bytes	Binary Offset
1	ITPROGFILT CONFIG header	-	-	Command header. See <i>Messages</i> on page 27 for more information.	-	H	0
2	frequency	See <i>Table 37: Frequency Types</i> on page 168		Set the frequency band on which to apply the filter	Enum	4	H
3	filterid	See <i>Table 34: Programmable Filter ID</i> on the next page		Select the filter ID to use	Enum	4	H+4
4	switch	DISABLE	0	Disable the filter	Enum	4	H+8
		ENABLE	1	Enable the filter			
5	filtermode	See <i>Table 35: Programmable Filter Mode</i> on the next page		Configure the type of filter to use (default = NONE)	Enum	4	H+12

Field	Field Type	ASCII Value	Binary Value	Description	Format	Binary Bytes	Binary Offset
6	cutofffreq			Center frequency for notch filter or cut off frequency for bandpass filter (MHz). Refer to ITPROGFILTBANK log (see page 495) for the allowable values. (default = 0)	Float	4	H+16
7	notchwidth			Notch width (MHz). Refer to ITPROGFILTBANK log (see page 495) for the allowable values. (default = 0)	Float	4	H+20

Table 34: Programmable Filter ID

Binary Value	ASCII Value	Description
0	PF0	Programmable Filter 0
1	PF1	Programmable Filter 1

Table 35: Programmable Filter Mode

Binary Value	ASCII Value	Description
0	NOTCHFILT	Configure the filter as a notch filter
1	BANDPASSFIL	Configure the filter as a bandpass filter
2	NONE	Turn off filter If the switch parameter is set to ENABLED while the filtermode parameter is set to NONE, the system will return a parameter out of range message.

2.52 ITSPECTRALANALYSIS

Enable and configure spectral analysis on receiver

Platform: OEM719, OEM729, OEM7500, OEM7600, OEM7700, OEM7720, PwrPak7, SPAN CPT7, SMART7

Use this command to view the spectrum in a range of frequencies. The **ITSPECTRALANALYSIS** command enables and configures the spectral analysis. The spectrum is viewed by plotting the PSD samples in the **ITPSDFINAL** log (see page 497).



Decreasing the update period or increasing the FFT size will impact receiver idle time. The idle time should be monitored to prevent adverse effects on receiver performance.

Message ID: 1967

Abbreviated ASCII Syntax:

```
ITSPECTRALANALYSIS mode [frequency] [updateperiod] [FFTsize] [timeavg]
[integration_window]
```

Factory Default:

```
ITSPECTRALANALYSIS off
```

ASCII Example:

```
ITSPECTRALANALYSIS predecimation gpsl1 500 1K 20 1
```

Field	Field Type	ASCII Value	Binary Value	Description	Format	Binary Bytes	Binary Offset
1	ITSPECTRAL ANALYSIS header	-	-	Command header. See <i>Messages</i> on page 27 for more information.	-	H	0
2	mode	See <i>Table 36: Data Sources for PSD Samples</i> on the next page		Set the view mode.	Enum	4	H
3	frequency	See <i>Table 37: Frequency Types</i> on page 168		Set the frequency band to view.	Enum	4	H+4

Field	Field Type	ASCII Value	Binary Value	Description	Format	Binary Bytes	Binary Offset
4	updateperiod	50 to 100000		The spectrum update rate in milliseconds. The update period is limited by the FFT size chosen. For 32k the minimum update period is 100 ms and for 64k the minimum update period is 200 ms. (default = 1000)	Ulong	4	H+8
5	FFTsize	See Table 38: FFT Sizes on page 169		The frequency resolution of the spectrum. (default = 1k)	Enum	4	H+12
6	timeavg	0 to 50		Time averaging window in seconds. 0 means no time averaging. (default = 10)	Ulong	4	H+16
7	integration window	1 to 1024		The integration window size of FFT samples. 1 means no integration. (default = 5)	Ulong	4	H+20

Table 36: Data Sources for PSD Samples

Binary Value	ASCII Value	Description
0	OFF	Disable spectral analysis
1	PREDECIMATION	Perform spectrum analysis on the pre-decimated spectrum. This can be used to see a wide view of the spectrum for an RF path (L1, L2 or L5).
2	POSTDECIMATION	Perform spectrum analysis on the post-decimated spectrum. This is narrower than predecimation and is used to see the spectrum for a given signal.
3	POSTFILTER	Perform spectrum analysis on the post-filtered spectrum. This can be used when either bandpass or notch filters have been enabled to see the spectrum after the filters are applied.



The post-filter spectrum is not available for the Galileo AltBOC frequency. Only the pre-decimation and post-decimation spectrums are available for Galileo AltBOC.

Table 37: Frequency Types

Binary Value	ASCII Value	Description
0	GPSL1	GPS L1 frequency
1	GPSL2	GPS L2 frequency
2	GLONASSL1	GLONASS L1 frequency
3	GLONASSL2	GLONASS L2 frequency
4	Reserved	
5	GPSL5	GPS L5 frequency
6 ¹	LBAND	Inmarsat L-Band frequency
7	GALILEOE1	Galileo E1 frequency
8	GALILEOE5A	Galileo E5A frequency
9	GALILEOE5B	Galileo E5B frequency
10	GALILEOALTBOC	Galileo AltBOC frequency
11	BEIDOU B1	BeiDou B1 frequency
12	BEIDOU B2	BeiDou B2 frequency
13	QZSSL1	QZSS L1 frequency
14	QZSSL2	QZSS L2 frequency
15	QZSSL5	QZSS L5 frequency
16	QZSSL6	QZSS L6 frequency
17	GALILEOE6	Galileo E6 frequency
18	BEIDOU B3	BeiDou B3 frequency
19	GLONASSL3	GLONASS L3 frequency
20	NAVICL5	NavIC L5 frequency
21	BEIDOU B1C	BeiDou B1C frequency
22	BEIDOU B2A	BeiDou B2a frequency

¹Must first enable L-Band using the ASSIGNLBANDBEAM command.

Table 38: FFT Sizes

Binary Value	ASCII Value	Description
0	1K	1K FFT, 1024 samples
1	2K	2K FFT, 2048 samples
2	4K	4K FFT, 4096 samples
3	8K	8K FFT, 8192 samples
4	16K	16K FFT, 16384 samples
5	32K	32K FFT, 32768 samples
6	64K	64K FFT, 65536 samples



The 64k FFT is not available in post-decimation or post-filter modes.

2.53 J1939CONFIG

Configure CAN network-level parameters

Platform: OEM719, OEM729, OEM7500, OEM7600, OEM7700, OEM7720, PwrPak7, SPAN CPT7, SMART7, SMART2

Use this command to configure the CAN J1939 network-level parameters (NAME, etc).

Issuing this command may initiate a CAN 'Address Claim' procedure. The status of the node and address claim are reported in the **J1939STATUS** log (see page 500).

Once a "node" is configured using **J1939CONFIG**, and the "port" is configured to ON using CANCONFIG "port" ON, J1939CONFIG "node" cannot be entered again until the "port" is configured to "OFF" using CANCONFIG "port" OFF. (See the **CANCONFIG** command on page 87)

Message ID: 1903

Abbreviated ASCII Syntax:

```
J1939CONFIG node port [pref_addr [alt_addr_range_start] [alt_addr_range_end]
[mfgcode] [industry] [devclass] [devinstance] [func] [funcinstance]
[ECUinstance]]
```

Factory Default:

```
J1939CONFIG NODE1 CAN1 1C 0 FD 305 2 0 0 23 0 0
```

```
J1939CONFIG NODE2 CAN2 1C 0 FD 305 2 0 0 23 0 0
```

ASCII Example :

```
J1939CONFIG NODE1 CAN1 AA 0 FD 305 2 0 0 23 0 0
```

Field	Field Type	ASCII Value	Binary Value	Description	Format	Binary Bytes	Binary Offset
1	J1939CONFIG header	-	-	Command header. See <i>Messages</i> on page 27 for more information.	-	H	0
2	node	NODE1	1	Identifies the J1939 Node (i.e., CAN NAME) Note: SMART2 does not support NODE2.	Enum	4	H
		NODE2	2				
3	port	CAN1	1	Physical CAN port to use Note: SMART2 does not support the CAN2 port.	Enum	4	H+4
		CAN2	2				
4	pref_addr	0x0 - 0xFD		Preferred CAN address. The receiver attempts to claim this address (default = 0x0)	Ulong	4	H+8

Field	Field Type	ASCII Value	Binary Value	Description	Format	Binary Bytes	Binary Offset
5	alt_addr_range_start	0x0 - 0xFD		When the pref_addr cannot be claimed, the receiver attempts to claim an address from this range. (default: 0x0)	Ulong	4	H+12
6	alt_addr_range_end	0x0 - 0xFD		End of alternative address range. (default: 0xFD)	Ulong	4	H+16
7	mfgcode	0-2047		NAME: Manufacturer Code. Refer to ISO 11783-5. (default: 0)	Ulong	4	H+20
8	industry	0 - 7		NAME: Industry Group (default: 2)	Ulong	4	H+24
9	devclass	0 - 127		NAME: Device Class (default: 0)	Ulong	4	H+28
10	devinstance	0 - 15		NAME: Device Class Instance (default: 0)	Ulong	4	H+32
11	func	0 - 255		NAME: Function (default: 23)	Ulong	4	H+36
12	funcinstance	0 - 31		NAME: Function instance (default: 0)	Ulong	4	H+40
13	ECUinstance	0 - 7		NAME: ECU Instance (default: 0)	Ulong	4	H+44



Due to current limitations in the CAN stack, NODE1 can only be associated with CAN1 and NODE2 can only be associated with CAN2. A mismatch combination results in an 'invalid parameter' error.



Node statistics are reported in the **J1939STATUS** log (see page 500).

2.54 LOCKOUT

Prevents the receiver from using a satellite

Platform: OEM719, OEM729, OEM7500, OEM7600, OEM7700, OEM7720, PwrPak7, SPAN CPT7, SMART7, SMART2

This command is used to prevent the receiver from using a satellite in the solution computations.



The **LOCKOUT** command does not prevent the receiver from tracking an undesirable satellite.

LOCKOUT command and **UNLOCKOUT** command (see page 319) can be used with GPS, GLONASS, SBAS and QZSS PRNs.

This command must be repeated for each satellite to be locked out. See also the **UNLOCKOUT** command on page 319 and **UNLOCKOUTALL** command on page 320.

Message ID: 137

Abbreviated ASCII Syntax:

```
LOCKOUT prn
```

Input Example:

```
LOCKOUT 8
```



The **LOCKOUT** command removes one or more satellites from the solution while leaving other satellites available.

Field	Field Type	ASCII Value	Binary Value	Description	Format	Binary Bytes	Binary Offset
1	LOCKOUT header	-	-	Command header. See <i>Messages</i> on page 27 for more information.	-	H	0
2	prn	Refer to <i>PRN Numbers</i> on page 46		Unique identifier for the satellite being locked out	Ulong	4	H

2.55 LOCKOUTSYSTEM

Prevents the receiver from using a system

Platform: OEM719, OEM729, OEM7500, OEM7600, OEM7700, OEM7720, PwrPak7, SPAN CPT7, SMART7, SMART2

This command is used to prevent the receiver from using all satellites in a system in the solution computations.



The **LOCKOUTSYSTEM** command does not prevent the receiver from tracking an undesirable satellite.

This command must be repeated for each system to be locked out. See also the **UNLOCKOUTSYSTEM** command on page 321 and **UNLOCKOUTALL** command on page 320.

Message ID: 871

Abbreviated ASCII Syntax:

```
LOCKOUTSYSTEM system
```

Factory Defaults:

```
LOCKOUTSYSTEM sbas
```

```
LOCKOUTSYSTEM navic
```



The **LOCKOUTSYSTEM** command removes one or more systems from the solution while leaving other systems available.

Field	Field Type	ASCII Value	Binary Value	Description	Format	Binary Bytes	Binary Offset
1	LOCKOUTSYSTEM header	-	-	Command header. See <i>Messages</i> on page 27 for more information.	-	H	0
2	system	See Table 93: <i>Satellite System</i> on page 477		A single satellite system to be locked out	Enum	4	H

2.56 LOG

Requests logs from the receiver

Platform: OEM719, OEM729, OEM7500, OEM7600, OEM7700, OEM7720, PwrPak7, SPAN CPT7, SMART7, SMART2

Many different types of data can be logged using different methods of triggering the log events. Every log element can be directed to any combination of the receiver's ports. The ontime trigger option requires the addition of the period parameter. See *Logs* on page 346 for further information and a complete list of data log structures. The LOG command tables in this section show the binary format followed by the ASCII command format.

The optional parameter [hold] prevents a log from being removed when the **UNLOGALL** command (see page 324), with its defaults, is issued. To remove a log which was invoked using the [hold] parameter requires the specific use of the **UNLOG** command (see page 322). To remove all logs that have the [hold] parameter, use the **UNLOGALL** command (see page 324) with the held field set to 1.

The [port] parameter is optional. If [port] is not specified, [port] is defaulted to the port that the command was received on.



1. The OEM7 family of receivers can handle 80 simultaneous log requests. If an attempt is made to log more than 80 logs at a time, the receiver responds with an Insufficient Resources error. Note that **RXSTATUSEVENTA** logs are requested on most ports by default and these logs count against the 80.
2. The user is cautioned that each log requested requires additional CPU time and memory buffer space. Too many logs may result in lost data and low CPU idle time. Receiver overload can be monitored using the idle-time field and buffer overload bits of the Receiver Status in any log header.
3. Only the **MARKPOS**, **MARK2POS**, **MARK3POS** and **MARK4POS** log (see page 515), **MARK1TIME**, **MARK2TIME**, **MARK3TIME** and **MARK4TIME** log (see page 518) and 'polled' log types are generated, on the fly, at the exact time of the mark. Synchronous and asynchronous logs output the most recently available data.
4. Use the ONNEW trigger with the **MARKPOS**, **MARK2POS**, **MARK3POS** and **MARK4POS** log (see page 515) and **MARK1TIME**, **MARK2TIME**, **MARK3TIME** and **MARK4TIME** log (see page 518).
5. Polled log types do not all allow fractional offsets.
6. If ONTIME trigger is used with asynchronous logs, the time stamp in the log does not necessarily represent the time the data was generated but rather the time when the log is transmitted.
7. Published logs are not placed in a queue if there is no physical or virtual connection when the log is generated. Thus, a log requested ONNEW or ONCHANGED that is in SAVECONFIG may not be received if it is published before connections are made. This can happen if there's no cable connected or if the communication protocol has not been established yet (e.g. CAN, Ethernet, USB, etc).

Message ID: 1

Abbreviated ASCII Syntax:

```

LOG [port] message ONNEW
LOG [port] message ONCHANGED
LOG [port] message ONTIME period [offset [hold]]
LOG [port] message ONNEXT
LOG [port] message ONCE
LOG [port] message ONMARK

```

Factory Default:

```

LOG COM1 RXSTATUSEVENTA ONNEW 0 0 HOLD
LOG COM2 RXSTATUSEVENTA ONNEW 0 0 HOLD
LOG COM3 RXSTATUSEVENTA ONNEW 0 0 HOLD
LOG USB1 RXSTATUSEVENTA ONNEW 0 0 HOLD
LOG USB2 RXSTATUSEVENTA ONNEW 0 0 HOLD
LOG USB3 RXSTATUSEVENTA ONNEW 0 0 HOLD
LOG ICOM1 RXSTATUSEVENTA ONNEW 0 0 HOLD
LOG ICOM2 RXSTATUSEVENTA ONNEW 0 0 HOLD
LOG ICOM3 RXSTATUSEVENTA ONNEW 0 0 HOLD
LOG ICOM4 RXSTATUSEVENTA ONNEW 0 0 HOLD
LOG ICOM5 RXSTATUSEVENTA ONNEW 0 0 HOLD
LOG ICOM6 RXSTATUSEVENTA ONNEW 0 0 HOLD
LOG ICOM7 RXSTATUSEVENTA ONNEW 0 0 HOLD

```

Abbreviated ASCII Example 1:

```
LOG COM1 BESTPOS ONTIME 7 0.5 HOLD
```

The above example shows **BESTPOS** logging to com port 1 at 7 second intervals and offset by 0.5 seconds (output at 0.5, 7.5, 14.5 seconds and so on). The [hold] parameter is set so that logging is not disrupted by the **UNLOGALL** command (see page 324).

To send a log once, the trigger option can be omitted.

Abbreviated ASCII Example 2:

```
LOG COM1 BESTPOS ONCE
```



Using the NovAtel Connect utility there are two ways to initiate data logging from the receiver's serial ports. Either enter the **LOG** command in the *Console* window or use the interface provided in the *Logging Control* window. Ensure the Power Settings on the computer are not set to go into Hibernate or Standby modes. Data is lost if one of these modes occurs during a logging session.

2.56.1 Binary

Field	Field Type	Binary Value	Description	Format	Binary Bytes	Binary Offset
1	LOG (binary) header	See Table 3: <i>Binary Message Header Structure</i> on page 31	This field contains the message header	-	H	0

Field	Field Type	Binary Value	Description	Format	Binary Bytes	Binary Offset
2	port	See <i>Table 4: Detailed Port Identifier</i> on page 33	Output port	Enum	4	H
3	message	Any valid message ID	Message ID of the log to output	Ushort	2	H+4
4	message type	Bits 0-4 = Measurement source ¹ Bits 5-6 = Format 00 = Binary 01 = ASCII 10 = Abbreviated ASCII, NMEA 11 = Reserved Bit 7 = Response Bit (<i>Message Responses</i> on page 42) 0 = Original Message 1 = Response Message	Message type of log	Char	1	H+6
5	Reserved			Char	1	H+7

¹Bits 0-4 are used to indicate the measurement source. For dual antenna receivers, if bit 0 is set, the log is from the secondary antenna.

Field	Field Type	Binary Value	Description	Format	Binary Bytes	Binary Offset
6	trigger	0 = ONNEW	Does not output current message but outputs when the message is updated (not necessarily changed)	Enum	4	H+8
		1 = ONCHANGED	Outputs the current message and then continues to output when the message is changed			
		2 = ONTIME	Output on a time interval			
		3 = ONNEXT	Output only the next message			
		4 = ONCE	Output only the current message (default). If no message is currently present, the next message is output when available.			
		5 = ONMARK	Output when a pulse is detected on the mark 1 input, MK1I ^{1 2}			
7	period	Valid values for the high rate logging are 0.01, 0.02, 0.05, 0.1, 0.2, 0.25 and 0.5. For logging slower than 1 Hz any integer value is accepted	Log period (for ONTIME trigger) in seconds If the value entered is lower than the minimum measurement period, the command will be rejected. See the SMART7 Installation and Operation User Manual for the maximum raw measurement rate to calculate the minimum period.	Double	8	H+12

¹Refer to the [SMART7 Installation and Operation User Manual](#) for more details on the MK1I pin. ONMARK only applies to MK1I. Events on MK2I (if available) do not trigger logs when ONMARK is used. Use the ONNEW trigger with the MARKTIME, MARK2TIME, MARKPOS or MARK2POS logs.

²Once the 1PPS signal has hit a rising edge, for both MARKPOS and MARKTIME logs, a resolution of both measurements is 10 ns. As for the ONMARK trigger for other logs that measure latency, for example RANGE and POSITION logs such as BESTPOS, it takes typically 20-30 ms (50 ms maximum) for the logs to output information from the 1PPS signal. Latency is the time between the reception of the 1PPS pulse and the first byte of the associated log. See also the **MARKPOS, MARK2POS, MARK3POS and MARK4POS** log on page 515 and the **MARK1TIME, MARK2TIME, MARK3TIME and MARK4TIME** log on page 518.

Field	Field Type	Binary Value	Description	Format	Binary Bytes	Binary Offset
8	offset	Offset for period (ONTIME trigger) in seconds.	<p>A valid value is any integer (whole number) smaller than the period.</p> <p>For example, to log data at 1 second, after every minute, set the period to 60 and the offset to 1.</p> <p>These decimal values, on their own, are also valid: 0.1, 0.2, 0.25 or 0.5, as well as any multiple of the maximum logging rate defined by the receiver model. The offset cannot be smaller than the minimum measurement period supported by the model.</p>	Double	8	H+20
9	hold	0 = NOHOLD	Allow log to be removed by the UNLOGALL command (see page 324)	Enum	4	H+28
		1 = HOLD	Prevent log from being removed by the default UNLOGALL command (see page 324)			

2.56.2 ASCII

Field	Field Name	ASCII Value	Description	Format
1	LOG (ASCII) header	-	This field contains the command name or the message header depending on whether the command is abbreviated ASCII or ASCII respectively	-
2	port	<i>Table 4: Detailed Port Identifier on page 33</i>	Output port (default = THISPORT)	Enum
3	message	Any valid message name, with an optional A or B suffix	Message name of log to output	Char []

Field	Field Name	ASCII Value	Description	Format
4	trigger	ONNEW	Output when the message is updated (not necessarily changed)	Enum
		ONCHANGED	Output when the message is changed	
		ONTIME	Output on a time interval	
		ONNEXT	Output only the next message	
		ONCE	Output only the current message (default)	
		ONMARK	Output when a pulse is detected on the mark 1 input, MK1I ^{2, 3}	
5	period	Any positive double value larger than the receiver's minimum raw measurement period	Log period (for ONTIME trigger) in seconds (default = 0) If the value entered is lower than the minimum measurement period, the command will be rejected. See the SMART7 Installation and Operation User Manual for the maximum raw measurement rate to calculate the minimum period.	Double
6	offset	Any positive double value smaller than the period	Offset for period (ONTIME trigger) in seconds (default = 0) For example, if you want to log data, at 1 second after every minute, set the period to 60 and the offset to 1.	Double
7	hold	NOHOLD	To be removed by the UNLOGALL command (see page 324) (default)	Enum
		HOLD	Prevent log from being removed by the default UNLOGALL command (see page 324)	

2.57 LOGIN

Start a secure ICOM/SCOM connection to the receiver

Platform: OEM729, OEM7600, OEM7700, OEM7720, PwrPak7, SPAN CPT7, SMART7-I, SMART7-SI

When ICOM/SCOM ports have security enabled (see the **IPSERVICE** command on page 156), a session to the ICOM/SCOM port can be established but commands are refused until a valid **LOGIN** command is issued. Both the UserName and Password are required. The **LOGIN** command checks the supplied credentials against known UserNames/Passwords and determines if the login is successful or not. A successful login permits the secured ICOM/SCOM command interpreter to accept further commands and returns OK. An unsuccessful login does not release the secured ICOM/SCOM command interpreter and returns Login Failed.

Entering a **LOGIN** command on any command port other than the ICOM/SCOM port has no effect, regardless of whether the UserName/Password is correct. In this case, the appropriate response (OK or Login Failed) is returned, but there is no effect on the command interpreter.



When security is enabled, access to the port is restricted unless a valid name and password are supplied. It does not mean there is data encryption enabled. Username is case-insensitive and password is case-sensitive.

Message ID: 1671

Abbreviated ASCII Syntax:

```
LOGIN [commport] UserName Password
```

ASCII Example:

```
LOGIN ADMIN ADMINPASSWORD
```

Field	Field Type	ASCII Value	Binary Value	Description	Format	Binary Bytes	Binary Offset
1	LOGIN header	-	-	Command header. See <i>Messages</i> on page 27 for more information.	-	H	0

Field	Field Type	ASCII Value	Binary Value	Description	Format	Binary Bytes	Binary Offset
2	commport	ICOM1	23	<p>The ICOM or SCOM port to log into.</p> <p>This is an optional parameter.</p> <p>If no value is entered, logs in to the ICOM port currently being used. (default=THISPORT)</p>	Enum	4	H
		ICOM2	24				
		ICOM3	25				
		ICOM4	29				
		ICOM5	46				
		ICOM6	47				
		ICOM7	48				
		SCOM1	49				
		SCOM2	50				
		SCOM3	51				
SCOM4	52						
3	username			<p>Provide the user name for the login command.</p> <p>The user name is not case sensitive.</p>	String [32]	variable 1	H+4
4	password			<p>Provide the password for the user name.</p> <p>The password is case sensitive.</p>	String [28]	variable 1	variable

¹In the binary case, each string field needs to be NULL terminated and additional bytes of padding added to maintain 4-byte alignment, up to the maximum defined by the string size. The next defined field starts immediately at the next 4-byte alignment following the NULL.

2.58 LOGOUT

End a secure ICOM/SCOM session started using the LOGIN command

Platform: OEM729, OEM7600, OEM7700, OEM7720, PwrPak7, SPAN CPT7, SMART7-I, SMART7-SI

Use the **LOGOUT** command to sign out of an ICOM/SCOM connection after a user has successfully logged in using the **LOGIN** command. After the sending the **LOGOUT** command, the ICOM/SCOM connection will not accept further commands, other than a new LOGIN command. The session itself is not ended. This only applies to ICOM/SCOM ports that have had security enabled (see the **IPSERVICE** command on page 156).

Message ID: 1672

Abbreviated ASCII Syntax:

```
LOGOUT [commport]
```

ASCII Example:

```
LOGOUT
```

Field	Field Type	ASCII Value	Binary Value	Description	Format	Binary Bytes	Binary Offset
1	LOGOUT header	-	-	Command header. See <i>Messages</i> on page 27 for more information.	-	H	0
2	commport	ICOM1	23	The ICOM or SCOM port from which to log out. This is an optional parameter. If no value is entered, logs out from the ICOM/SCOM port currently being used.	Enum	4	H
		ICOM2	24				
		ICOM3	25				
		ICOM4	29				
		ICOM5	46				
		ICOM6	47				
		ICOM7	48				
		SCOM1	49				
		SCOM2	50				
		SCOM3	51				
		SCOM4	52				

2.59 LUA

Configure Lua Interpreter

Platform: OEM719, OEM729, OEM7500, OEM7600, OEM7700, OEM7720, PwrPak7, SPAN CPT7, SMART7

Use this command to configure the execution of the Lua interpreter on the receiver. Scripts that appear within the **LUAFILELIST** log (see page 510) can be executed by the Lua interpreter.

Message ID: 2049

Abbreviated ASCII Syntax:

```
LUA option [LuaInterpreterArguments]
```

Abbreviated ASCII Example:

```
lua start "printarguments.lua 1 2 3 4 5"
```

Field	Field Type	ASCII Value	Binary Value	Description	Format	Binary Bytes	Binary Offset
1	Lua header	-	-	Command header. See Messages for more information.	-	H	0
2	option	START	1	Start the Lua interpreter in the background. The file descriptors stdout, stdin and stderr will not be accessible outside the receiver.	Enum	4	H
		PROMPT	2	Start the Lua interpreter in interactive mode and connect stdout, stdio and stderr to the port on which the command was entered. The INTERFACEMODE of that port will be changed to LUA for both RX and TX.			

Field	Field Type	ASCII Value	Binary Value	Description	Format	Binary Bytes	Binary Offset
3	LuaInterpreter Arguments	STRING		String containing Lua interpreter options including the name of the script file to run and arguments to pass to the script. This string must be enclosed in quotes if it contains any spaces. String arguments within the field must be enclosed by single quotes.	String [400]	Variable	H+4

The format of the Lua Interpreter Arguments is as follows as adapted from the standard Lua 5.3 interpreter:

```
[options] [script [args]]
```

Available options are:

```
-e stat execute string 'stat'
```

```
-i enter interactive mode after executing 'script'.
```

(This is added to the arguments when using the PROMPT option of the LUA command)

```
-l name require library 'name'
```

2.60 MAGVAR

Sets a magnetic variation correction

Platform: OEM719, OEM729, OEM7500, OEM7600, OEM7700, OEM7720, PwrPak7, SPAN CPT7, SMART7, SMART2

The receiver computes directions referenced to True North (also known as geodetic north). The Magnetic Variation Correction command (MAGVAR) is used to navigate in agreement with magnetic compass bearings. The correction value entered here causes the "bearing" field of the navigate log to report bearing in degrees Magnetic. The receiver computes the magnetic variation correction when using the auto option. See *Figure 2: Illustration of Magnetic Variation and Correction* on the next page.

The receiver calculates values of magnetic variation for given values of latitude, longitude and time using the International Geomagnetic Reference Field (IGRF) 2015 spherical harmonic coefficients and IGRF time corrections to the harmonic coefficients. (IGRF-2015 is also referred to as IGRF-12.) The model is intended for use up to the year 2020, however due to accelerated drift of the earth's magnetic north pole starting in 2018, the accuracy of the model will degrade sooner than the intended date. Furthermore, the receiver will compute for years beyond 2020, but accuracy may be further reduced depending on the behavior of the magnetic pole.

Message ID: 180

Abbreviated ASCII Syntax:

```
MAGVAR type [correction [std dev]]
```

Factory Default:

```
MAGVAR correction 0 0
```

ASCII Example 1:

```
MAGVAR AUTO
```

ASCII Example 2:

```
MAGVAR CORRECTION 15 0
```

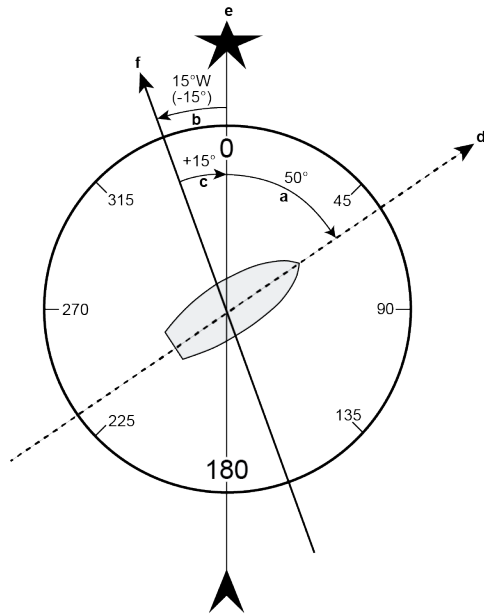
Figure 2: Illustration of Magnetic Variation and Correction

Ref	Description
a	True Bearing
b	Local Magnetic Variation
c	Local Magnetic Variation Correction (Inverse of magnetic variation)
a + c	Magnetic Bearing
d	Heading: 50° True, 65° Magnetic
e	True North
f	Local Magnetic North



How does GNSS determine what Magnetic North is? Do the satellites transmit a database or some kind of look up chart to determine the declination for your given latitude and longitude? How accurate is it?

Magnetic North refers to the location of the Earth's Magnetic North Pole. Its position is constantly changing in various cycles over centuries, years and days. These rates of change vary and are not well understood. However, we are able to monitor the changes.

True North refers to the earth's spin axis, that is, at 90° north latitude or the location where the lines of longitude converge. The position of the spin axis does not vary with respect to the Earth.

The locations of these two poles do not coincide. Thus, a relationship is required between these two values for users to relate GNSS bearings to their compass bearings. This value is called the magnetic variation correction or declination.

GNSS does not determine where Magnetic North is nor do the satellites provide magnetic correction or declination values. However, OEM7 receivers store this information internally in look up tables so that when you specify that you want to navigate with respect to Magnetic North, this internal information is used. These values are also available from various information sources such as the United States Geological Survey (USGS). The USGS produces maps and has software which enables the determination of these correction values. By identifying your location (latitude and longitude), you can obtain the correction value. Refer to [An Introduction to GNSS](#) available on our website.

Field	Field Type	ASCII Value	Binary Value	Description	Format	Binary Bytes	Binary Offset
1	MAGVAR header	-	-	Command header. See <i>Messages</i> on page 27 for more information.	-	H	0
2	type	AUTO	0	Use IGRF corrections	Enum	4	H
		CORRECTION	1	Use the correction supplied			
3	correction	± 180.0 degrees		Magnitude of correction (Required field if type = Correction)	Float	4	H+4
4	std_dev	± 180.0 degrees		Standard deviation of correction (default = 0)	Float	4	H+8

2.61 MODEL

Switches to a previously authorized model

Platform: OEM719, OEM729, OEM7500, OEM7600, OEM7700, OEM7720, PwrPak7, SPAN CPT7, SMART7, SMART2

This command is used to switch the receiver between models previously added with the **AUTH** command (see page 63). When the **MODEL** command is issued, the receiver saves the specified model as the active model. The active model is now used on every subsequent start up. The **MODEL** command causes an automatic reset.

Use the **VALIDMODELS** log (see page 794) to output a list of available models on the receiver. Use the **VERSION** log (see page 796) to output the active model. Use the **AUTHCODES** log (see page 356) to output a list of the auth codes present on the receiver.



If the **MODEL** command is used to switch to an expired model, the receiver will reset and enter into an error state. Switch to a valid model to continue.

Message ID: 22

Abbreviated ASCII Syntax:

```
MODEL model
```

Input Example:

```
MODEL DDNRNNTBN
```



NovAtel uses the term models to refer to and control different levels of functionality in the receiver firmware. For example, a receiver may be purchased with an L1 only capability and be easily upgraded at a later time to a more feature intensive model, like L1/L2 dual-frequency. All that is required to upgrade is an authorization code for the higher model and the **AUTH** command (see page 63). Reloading the firmware or returning the receiver for service to upgrade the model is not required. Upgrades are available from [NovAtel Customer Support](#).

Field	Field Type	ASCII Value	Binary Value	Description	Format	Binary Bytes	Binary Offset
1	MODEL header	-	-	Command header. See <i>Messages</i> on page 27 for more information.	-	H	0
2	model	Max 16 character null-terminated string (including the null)		Model name	String [max 16]	Variable 1	H

¹In the binary case, each string field needs to be NULL terminated and additional bytes of padding added to maintain 4-byte alignment, up to the maximum defined by the string size. The next defined field starts immediately at the next 4-byte alignment following the NULL.

2.62 MOVINGBASESTATION

Enables the use of a moving base station

Platform: OEM719, OEM729, OEM7500, OEM7600, OEM7700, OEM7720, PwrPak7, SPAN CPT7, SMART7, SMART2

This command is used to enable or disable a receiver from transmitting corrections without a fixed position.

The moving base function allows you to obtain a centimeter level xyz baseline estimate when the base station and possibly the rover are moving. It is very similar to normal RTK, with one stationary base station and a moving rover (refer to Transmitting and Receiving Corrections in the [SMART7 Installation and Operation User Manual](#)). The BSLNXYZ log is an asynchronous 'matched' log that can be logged with the onchanged trigger to provide an accurate baseline between the base and rover.

Due to the latency of the reference station position messages, the following logs are not recommended to be used when in moving baseline mode: BESTXYZ, GPGST, MARKPOS, MARK2POS, MATCHEDPOS, MATCHEDEYZ, RTKPOS and RTKXYZ. The position error of these logs could exceed 100 m, depending on the latency of the reference station position message. If a rover position is required during moving basestation mode, then PSRPOS is recommended.

The **MOVINGBASESTATION** command must be used to allow the base to transmit messages without a fixed position.



1. Use the PSRPOS position log at the rover. It provides the best accuracy and standard deviations when the MOVINGBASESTATION mode is enabled.
2. This command supports RTCM V3 operation.
3. RTCM V3 support includes GPS + GLONASS operation.

Message ID: 763

Abbreviated ASCII Syntax:

```
MOVINGBASESTATION switch
```

Factory Default:

```
MOVINGBASESTATION disable
```

ASCII Example:

```
MOVINGBASESTATION ENABLE
```



Consider the case where there is a fixed base, an airplane flying with a moving base station near its front and a rover station at its tail end. Corrections can be sent between the receivers in a 'daisy chain' effect, where the fixed base station sends corrections to the moving base station, which in turn can send corrections to the rover.

Figure 3: Moving Base Station 'Daisy Chain' Effect

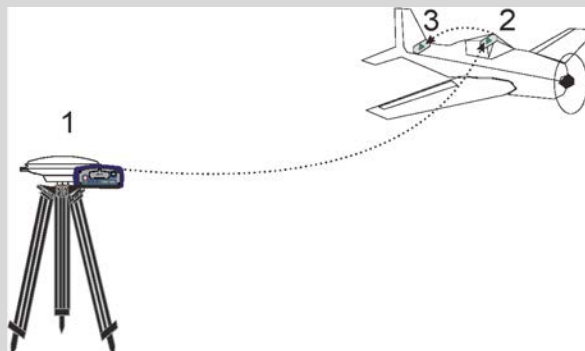

When using this method, the position type is only checked at the fixed base station. Moving base stations will continue to operate under any conditions.

This command is useful for moving base stations doing RTK positioning at sea. A rover station is used to map out local areas (for marking shipping lanes, hydrographic surveying and so on), while the base station resides on the control ship. The control ship may not move much (parked at sea), but there is a certain amount of movement due to the fact that it is floating in the ocean. By using the **MOVINGBASESTATION** command, the control ship is able to use RTK positioning and move to new survey sites.

Field	Field Type	ASCII Value	Binary Value	Description	Format	Binary Bytes	Binary Offset
1	MOVING BASESTATION header	-	-	Command header. See <i>Messages</i> on page 27 for more information.	-	H	0
2	switch	DISABLE	0	Do not transmit corrections without a fixed position.	Enum	4	H
		ENABLE	1	Transmit corrections without a fixed position.			

2.63 NAVICECUTOFF

Sets elevation cut-off angle for NavIC satellites

Platform: OEM719, OEM729, OEM7500, OEM7600, OEM7700, OEM7720, PwrPak7, SPAN CPT7, SMART7

This command is used to set the elevation cut-off angle for tracked NavIC satellites. The receiver does not start automatically searching for a NavIC satellite until it rises above the cut-off angle (when satellite position is known). Tracked satellites that fall below the cut-off angle are no longer tracked unless they are manually assigned (see the **ASSIGN** command on page 56).

In either case, satellites below the NAVICECUTOFF angle are eliminated from the internal position and clock offset solution computations.

This command permits a negative cut-off angle; it could be used in these situations:

- The antenna is at a high altitude, and thus can look below the local horizon
- Satellites are visible below the horizon due to atmospheric refraction



Care must be taken when using **NAVICECUTOFF** command because the signals from lower elevation satellites are traveling through more atmosphere and are therefore degraded. Use of satellites below 5 degrees is not recommended.



Use the **ELEVATIONCUTOFF** command on page 114 to set the cut-off angle for all other systems.



For dual antenna receivers, this command applies to both the primary and secondary antennas.

Message ID: 2134

Abbreviated ASCII Syntax:

```
NAVICECUTOFF angle
```

Factory Default:

```
NAVICECUTOFF 5.0
```

ASCII Example:

```
NAVICECUTOFF 10.0
```

Field	Field Type	ASCII Value	Binary Value	Description	Format	Binary Bytes	Binary Offset
1	NAVICECUTOFF header	-	-	Command header. See <i>Messages</i> on page 27 for more information.	-	H	0
2	angle	±90.0 degrees		Elevation cut-off angle relative to horizon	Float	4	H

2.64 NMEAFORMAT

Customize NMEA output

Platform: OEM719, OEM729, OEM7500, OEM7600, OEM7700, OEM7720, PwrPak7, SPAN CPT7, SMART7, SMART2

Use the NMEAFORMAT command to customize the NMEA GPGGA and GPGGALONG output.



Modifying the NMEA output will make it not compliant with the NMEA standard.

Message ID: 1861

Abbreviated ASCII Syntax:

```
NMEAFORMAT field format
```

Factory Default:

```
NMEAFORMAT GGA_LATITUDE 9.4
NMEAFORMAT GGA_LONGITUDE 10.4
NMEAFORMAT GGA_ALTITUDE .2
NMEAFORMAT GGALONG_LATITUDE 12.7
NMEAFORMAT GGALONG_LONGITUDE 13.7
NMEAFORMAT GGALONG_ALTITUDE .3
```

Example:

The following settings increase the precision of the GPGGA latitude and longitude fields:

```
NMEAFORMAT GGA_LATITUDE 11.6
NMEAFORMAT GGA_LONGITUDE 12.6
```

The following settings decrease the precision of the GPGGALONG latitude and longitude fields:

```
NMEAFORMAT GGALONG_LATITUDE 11.6
NMEAFORMAT GGALONG_LONGITUDE 12.6
```

The following setting stops the undulation fields of the GPGGALONG log being filled, making a log like the GPGGARTK log that was in NovAtel's OEM6 firmware:

```
NMEAFORMAT GGALONG_UNDULATION !0
```

Field	Field Type	ASCII Value	Binary Value	Description	Format	Binary Bytes	Binary Offset
1	NMEA FORMAT Header	-	-	Command header. See <i>Messages</i> on page 27 for more information.	-	H	0

Field	Field Type	ASCII Value	Binary Value	Description	Format	Binary Bytes	Binary Offset
2	Field	GGA_LATITUDE	0	GPGGA latitude field	Enum	4	H
		GGA_LONGITUDE	1	GPGGA longitude field			
		GGA_ALTITUDE	2	GPGGA altitude (height) field			
		GGA_UNDULATION	3	GPGGA undulation field			
		GGALONG_LATITUDE	10	GPGGALONG latitude field			
		GGALONG_LONGITUDE	11	GPGGALONG longitude field			
		GGALONG_ALTITUDE	12	GPGGALONG altitude (height) field			
		GGALONG_UNDULATION	13	GPGGALONG undulation field			

Field	Field Type	ASCII Value	Binary Value	Description	Format	Binary Bytes	Binary Offset
3	Format	Char[8]		<p>The Format field has a syntax similar to the printf function commonly found in programming languages. The format is:</p> <p style="padding-left: 40px;">!x.y</p> <p>Where:</p> <p>y is the number of digits to display after the decimal point</p> <p>x sets the minimum field width including the decimal point. X is optional if ! is not used. If the value requires fewer digits than x, leading zeros are added to the output.</p> <p>! forces the field width to x. ! is optional. If a value exceeds the permitted width, the value will be saturated. If ! is used, y must be less than x.</p> <p>Examples (GGA_LATITUDE):</p> <p style="padding-left: 40px;">.5 = 5106.98120</p> <p style="padding-left: 40px;">2.3 = 5106.981</p> <p style="padding-left: 40px;">7.1 = 05107.0</p> <p style="padding-left: 40px;">!7.2 = 5106.98</p> <p style="padding-left: 40px;">!7.3 = 999.999</p>	Char[8]	8	H+4

2.65 NMEATALKER

Sets the NMEA talker ID

Platform: OEM719, OEM729, OEM7500, OEM7600, OEM7700, OEM7720, PwrPak7, SPAN CPT7, SMART7, SMART2

This command is used to alter the behavior of the NMEA talker ID. The talker is the first 2 characters after the \$ sign in the log header of the GPGLL, GPGRS, GPGSA, GPGST, GPGSV, GPRMB, GPRMC, GPVTG and GPZDA log outputs. The other NMEA logs are not affected by the NMEATALKER command.



On SPAN systems, the GPGBA position is always based on the position solution from the BESTPOS log which incorporate GNSS + INS solutions as well.

The default GPS NMEA messages (**NMEATALKER GP**) include specific information about only the GPS satellites that have a 'GP' talker solution, even when GLONASS satellites are present. As well, the default GPS NMEA message outputs GP as the talker ID regardless of the position type given in position logs such as BESTPOS. The **NMEATALKER AUTO** command changes this behavior so that the NMEA messages include all satellites in the solution and the talker ID changes according to those satellites.

If **NMEATALKER** is set to **auto** and there are systems other than GPS in the solution, there will be multiple sentences with different talker IDs.

For instance, if both GPS and GLONASS satellites are in the solution, two sentences with the GN talker ID are output. The first sentence contains information about the GPS and the second sentence contains the GLONASS satellites in the solution. In another example, if **NMEATALKER** is set to **auto** and there are only GLONASS satellites in the solution, the talker ID of this message is GL.



If the solution comes from SPAN, the talker ID is IN.

Message ID: 861

Abbreviated ASCII Syntax:

```
NMEATALKER id
```

Factory Default:

```
NMEATALKER gp
```

ASCII Example:

```
NMEATALKER auto
```

Field	Field Type	ASCII Value	Binary Value	Description	Format	Binary Bytes	Binary Offset
1	NMEATALKER header	-	-	Command header. See <i>Messages</i> on page 27 for more information.	-	H	0
2	ID	GP	0	GPS (GP) only	Enum	4	H
		AUTO	1	GPS, Inertial (IN) and/or GLONASS			



The NMEATALKER command only affects NMEA logs that are capable of a GPS output. For example, GLMLA is a GLONASS-only log and the output will always use the GL talker. *Table 39: NMEA Talkers* below shows the NMEA logs and whether they use GPS (GP), GLONASS (GL), Galileo (GA), or combined (GN) talkers with NMEATALKER AUTO.

Table 39: NMEA Talkers

Log	Talker IDs
GLMLA	GL
GPALM	GP
GPGGA	GP
GPGLL	GA or GL or GN or GP
GPGRS	GA or GL or GN or GP
GPGSA	GA or GL or GN or GP
GPGST	GA or GL or GN or GP
GPGSV	GA or GL or GP
GPRMB	GA or GL or GN or GP
GPRMC	GA or GL or GN or GP
GPVTG	GA or GL or GN or GP
GPZDA	GP

2.66 NMEAVERSION

Sets the NMEA Version for Output

Platform: OEM719, OEM729, OEM7500, OEM7600, OEM7700, OEM7720, PwrPak7, SPAN CPT7, SMART7, SMART2

Use this command to set the output version of NMEA messages.

Message ID: 1574

Abbreviated ASCII Syntax:

```
NMEAVERSION Version
```

Factory Defaults:

```
NMEAVERSION V31
```

ASCII Example:

```
NMEAVERSION V41
```

Field	Field Type	ASCII Value	Binary Value	Description	Format	Binary Bytes	Binary Offset
1	NMEAVERSION header	-	-	Command header. See <i>Messages</i> on page 27 for more information.	-	H	0
2	Version	V31	0	NMEA messages will be output in NMEA version 3.10 format.	Enum	4	H
		V41	1	NMEA messages will be output in NMEA version 4.10 format.			

2.67 NTRIPCONFIG

Configures NTRIP

Platform: OEM729, OEM7600, OEM7700, OEM7720, PwrPak7, SPAN CPT7, SMART7

This command sets up and configures NTRIP communication.

Message ID: 1249

Abbreviated ASCII Syntax:

```
NTRIPCONFIG port type [protocol [endpoint [mountpoint [username [password
[bindinterface]]]]]]
```



Mountpoint, username and password are all set up on the caster.

Factory Default:

```
NTRIPCONFIG ncom1 disabled
NTRIPCONFIG ncom2 disabled
NTRIPCONFIG ncom3 disabled
NTRIPCONFIG ncomX disabled
```

ASCII Example:

```
NTRIPCONFIG ncom1 client v1 :2000 calg0
```

ASCII example (NTRIP client):

```
NTRIPCONFIG ncom1 client v2 192.168.1.100:2101 RTCM3 calgaryuser calgarypwd
```

ASCII example (NTRIP server):

```
NTRIPCONFIG ncom1 server v1 192.168.1.100:2101 RTCM3 "" casterpwd
```

Field	Field Type	ASCII Value	Binary Value	Description	Format	Binary Bytes	Binary Offset
1	NTRIPCONFIG Header	-	-	Command header. See <i>Messages</i> on page 27 for more information.	-	H	0
2	port	NCOM1	26	Name of the port see <i>Table 25: Communications Port Identifiers</i> on page 110	Enum	4	H
		NCOM2	27				
		NCOM3	28				

Field	Field Type	ASCII Value	Binary Value	Description	Format	Binary Bytes	Binary Offset
3	type	DISABLED	1	NTRIP type	Enum	4	H+4
		CLIENT	2				
		SERVER	3				
4	protocol	V1	1	Protocol (default V1)	Enum	4	H+8
		V2	2				
5	endpoint	Max 80 character string		Endpoint to wait on or to connect to where host is a hostname or IP address and port is the TCP/UDP port number (default = 80)	String [80]	variable ¹	H+12
6	mountpoint	Max 80 character string		Which mount point to use	String [80]	variable ¹	variable
7	user name	Max 30 character string		Login user name	String [30]	variable ¹	variable
8	password	Max 30 character string		Password	String [30]	variable ¹	variable
9	bindInterface	ALL (default)	1	Not supported. Set to <i>ALL</i> for future compatibility.	Enum	4	variable

¹In the binary case, each string field needs to be NULL terminated and additional bytes of padding added to maintain 4-byte alignment, up to the maximum defined by the string size. The next defined field starts immediately at the next 4-byte alignment following the NULL.

2.68 NTRIPSOURCETABLE

Set *NTRIP* caster endpoints

Platform: OEM729, OEM7600, OEM7700, OEM7720, PwrPak7, SPAN CPT7, SMART7

This command is used to set the NTRIP caster endpoints to be used for the **SOURCETABLE** log (see page 773).

Message ID: 1343

Abbreviated ASCII Syntax:

```
NTRIPSOURCETABLE endpoint [reserved1] [reserved2]
```

Factory Default:

```
NTRIPSOURCETABLE none
```

ASCII Example:

```
NTRIPSOURCETABLE base.station.novatel.ca:1001
```

```
NTRIPSOURCETABLE 192.168.1.100:1001
```

Field	Field Type	ASCII Value	Binary Value	Description	Format	Binary Bytes	Binary Offset
1	NTRIP SOURCETABLE header	-		Command header. See <i>Messages</i> on page 27 for more information.	-	H	0
2	Endpoint	Max 80 character string		Endpoint, in format of host:port, to connect to where the host is a hostname or IP address and port is the TCP/IP port number	String [80]	variable ¹	H
3	Reserved1	Reserved		Reserved	Ulong	4	variable
4	Reserved2	Reserved		Reserved	Ulong	4	variable

¹In the binary case, each string field needs to be NULL terminated and additional bytes of padding added to maintain 4-byte alignment, up to the maximum defined by the string size. The next defined field starts immediately at the next 4-byte alignment following the NULL.

2.69 NVMRESTORE

Restores NVM data after an NVM failure

Platform: OEM719, OEM729, OEM7500, OEM7600, OEM7700, OEM7720, PwrPak7, SPAN CPT7, SMART7, SMART2

This command is used to restore Non-Volatile Memory (NVM) data after a NVM Fail error. This failure is indicated by bit 15 of the receiver error word being set (see also **RXSTATUS** command on page 686 and **RXSTATUSEVENT** command on page 699). If corrupt NVM data is detected, the receiver remains in the error state and continues to flash an error code on the Status LED until the **NVMRESTORE** command is issued (refer to Built-In Status Tests in the [SMART7 Installation and Operation User Manual](#) for further explanation).

After entering the **NVMRESTORE** command and resetting the receiver, the communications link may have to be reestablished at a different baud rate from the previous connection.

Message ID: 197

Abbreviated ASCII Syntax:

NVMRESTORE



The possibility of NVM failure is extremely remote, however, if it should occur it is likely that only a small part of the data is corrupt. This command is used to remove the corrupt data and restore the receiver to an operational state. The data lost could be the user configuration, almanac, model or other reserved information.

2.70 NVMUSERDATA

Write User Data to NVM

Platform: OEM719, OEM729, OEM7500, OEM7600, OEM7700, OEM7720, PwrPak7, SPAN CPT7, SMART7, SMART2

This command writes the data provided in the data array to NVM. This data can be retrieved by issuing the command **LOG NVMUSERDATA**.

The user data is maintained through power cycles and a standard **FRESET** command (see page 127). To clear the user data, use the **FRESET USERDATA** command.



The user data may be deleted if the **NVMRESTORE** command (see page 202) is sent. NVMRESTORE should be used with caution and is meant for use only in the event of a NVM receiver error.

Message ID: 1970

Abbreviated ASCII Syntax:

NVMUSERDATA #bytes data

Field	Field Type	Binary Value	Description	Binary Format	Binary Bytes	Binary Offset
1	NVMUSERDATA header	-	Command header. See <i>Messages</i> on page 27 for more information.	-	H	0
2	#bytes	-	Number of bytes of data to follow	Ulong	4	H
3	data	-	User input data up to a maximum of 2000 bytes. Data is entered in hexadecimal values with no separators between the values. For example, 1a2b3c4e	Uchar	2000	H+4

2.71 OUTPUTDATUM

Choose the datum to output PPP solutions in

Platform: OEM719, OEM729, OEM7500, OEM7600, OEM7700, OEM7720, PwrPak7, SPAN CPT7, SMART7, SMART2

This command is used to select the geodetic datum and co-ordinate epoch in which PPP solutions are output. If not set, the factory default value is the service datum and epoch of the PPP corrections. For TerraStar and Veripos, this is ITRF2014 and the current epoch.

For either a plate-fixed or earth-fixed output datum, using a fixed epoch will compensate for plate motion such that you get repeatable co-ordinates over time for a location. Compensation is controlled using the **TECTONICSCOMPENSATIONSOURCE** command on page 300 and reported by the **TECTONICSCOMPENSATION** log (see page 776). The **TECTONICSCOMPENSATION** log will warn when operating in a region where tectonics compensation may be imprecise.

In order for solutions to be transformed to the requested datum, the datum selected must be in the list of datums shown in the **GEODETICDATUMS** log (see page 421), and there must be a transformation between the service datum and the target datum as reported by the **DATUMTRANSFORMATIONS** log (see page 404).

To view the current datum, use the **BESTDATUMINFO** log (see page 368).

Note, in future firmware versions **OUTPUTDATUM** will transform the coordinates from other solution types.

Message ID: 1144

Abbreviated ASCII Syntax:

```
OUTPUTDATUM name epoch_option epoch
```

Factory Default:

```
OUTPUTDATUM SERVICE SERVICE_EPOCH 0
```

ASCII Example:

To output co-ordinates in NAD83(CSRS), 2018:

```
OUTPUTDATUM NAD83(CSRS) FIXED_EPOCH 2018.000
```

To output co-ordinates in ITRF2014, 2010.00:

```
OUTPUTDATUM ITRF2014 FIXED_EPOCH 2010.000
```



The **OUTPUTDATUM** command only accepts a non-zero epoch if the **FIXED_EPOCH** option is specified. The earliest fixed epoch is 1900.



Do not mix the **OUTPUTDATUM** command and the **DATUM USER** commands.

Field	Field Type	ASCII Value	Binary Value	Description	Format	Binary Bytes	Binary Offset
1	OUTPUTDATUM header	-	-	Command header. See <i>Messages</i> on page 27 for more information.	-	H	0
2	name			The datum output.	Char [32]	variable	H
3	epoch_option	<i>See Table 40: Epoch Options below</i>		Epoch type to enter coordinates in.	Enum	4	variable
4	epoch			Epoch to output coordinates in. (default = 0)	Double	8	variable

Table 40: Epoch Options

Binary	ASCII	Description
0	SERVICE_EPOCH	Output coordinates in the epoch of the corrections (default)
1	FIXED_EPOCH	Output coordinates in the specified epoch
2	CURRENT_EPOCH	Output coordinates in the current epoch

2.72 PDPFILTER

Enables, disables or resets the PDP filter

Platform: OEM719, OEM729, OEM7500, OEM7600, OEM7700, OEM7720, PwrPak7, SPAN CPT7, SMART7, SMART2

This command is used to enable, disable or reset the Pseudorange/Delta-Phase (PDP) filter. The main advantages of the PDP implementation are:

- Smooths a jumpy position
- Bridges outages in satellite coverage (the solution is degraded from normal but there is at least a reasonable solution without gaps)



Enable the PDP filter to output the PDP solution in the **BESTPOS** log (see page 371), **BESTVEL** log (see page 387) and *NMEA Standard Logs* on page 543.

Refer to PDP and GLIDE Configurations in the [SMART7 Installation and Operation User Manual](#) for information on configuring your receiver for PDP or GLIDE® operation.

2.72.1 GLIDE Position Filter

GLIDE is a mode of the PDP¹ filter that optimizes the position for consistency over time rather than absolute accuracy. This is ideal in clear sky conditions where the user needs a tight, smooth and consistent output. The GLIDE filter works best with SBAS. The PDP filter is smoother than a least squares solution but is still noisy in places. The GLIDE filter produces a very smooth solution with relative rather than absolute position accuracy. There should typically be less than 1 centimeter difference in error from epoch to epoch. GLIDE also works in single point and DGPS modes. See also the **PDPMODE** command on page 208 and the **PDPPPOS** log on page 562, **PDPVEL** log on page 566 and **PDPXYZ** log on page 567.

Message ID: 424

Abbreviated ASCII Syntax:

```
PDPFILTER switch
```

Factory Default:

```
PDPFILTER disable
```

ASCII Example:

```
PDPFILTER enable
```

¹Refer also to our application note [APN038 on Pseudorange/Delta-Phase \(PDP\)](#), available on our website at www.novatel.com/support/search.

Field	Field Type	ASCII Value	Binary Value	Description	Format	Binary Bytes	Binary Offset
1	PDPFILTER header	-	-	Command header. See <i>Messages</i> on page 27 for more information.	-	H	0
2	switch	DISABLE	0	Disable the PDP filter.	Enum	4	H
		ENABLE	1	Enable the PDP filter.			
		RESET	2	Reset the PDP filter. A reset clears the filter memory so that the PDP filter can start over.			

2.73 PDPMODE

Selects the PDP mode and dynamics

Platform: OEM719, OEM729, OEM7500, OEM7600, OEM7700, OEM7720, PwrPak7, SPAN CPT7, SMART7, SMART2

This command is used to select the mode and dynamics of the PDP filter.



The **PDPFILTER ENABLE** command (see the **PDPFILTER** command on page 206) must be entered before the **PDPMODE** command.

It is recommended that the ionotype be left at AUTO when using either normal mode PDP or GLIDE. See also the **SETIONOTYPE** command on page 286.

Message ID: 970

Abbreviated ASCII Syntax:

```
PDPMODE mode dynamics
```

Factory Default:

```
PDPMODE normal auto
```

ASCII Example:

```
PDPMODE relative dynamic
```

Field	Field Type	ASCII Value	Binary Value	Description	Format	Binary Bytes	Binary Offset
1	PDPMODE header	-	-	Command header. See <i>Messages</i> on page 27 for more information.	-	H	0
2	mode	NORMAL	0	In RELATIVE or GLIDE mode, GLIDE performance is optimized to obtain a consistent error in latitude and longitude over time periods of 15 minutes or less, rather than to obtain the smallest absolute position error. See also <i>GLIDE Position Filter</i> on page 206 for GLIDE mode additional information. GLIDE mode is the same as RELATIVE mode.	Enum	4	H
		RELATIVE	1				
		GLIDE	3				
3	dynamics	AUTO	0	Auto detect dynamics mode	Enum	4	H+4
		STATIC	1	Static mode			
		DYNAMIC	2	Dynamic mode			

2.74 \$PMDT

Configure Terrain Compensation

Platform: SMART7, SMART7-I, SMART7-W, SMART2-TB

Use this NMEA style command to configure the Terrain Compensation feature. The Terrain Compensation filter must be enabled using the **TILTCOMPENSATIONCONTROL** command (see page 305) for the Terrain Compensation feature to function.



The maximum antenna height allowed is 500 inches (12.7 meters).



The **TILTFILTER** command (see page 306) and **TILTZERO** command (see page 307) can also be used to configure the Terrain Compensation filter.

Message ID: 2308



Syntax

```
$PMDT,a,x,x,x,x.x*hh[CR][LF]
```

ASCII Example:

```
$PMDT,u,,1,1*78
```

Field	Structure	Description	Format	Symbol	Example
1	\$PMDT	Command header. See <i>Messages</i> on page 27 for more information.	-	\$PMDT	\$PMDT
2	function	The function to perform, where: l = Set level state u = Set/Get antenna height x = Save level and height values r = Clear the saved level and height values Required field.	Char	a	,u
3	reserved	Reserved field, leave empty.	-	x	,
4	antenna height feet	Antenna height in feet. Will be combined with the <i>antenna height inches</i> field.  Cannot be combined with the <i>antenna height meters</i> field.	Integer	x	,1

Field	Structure	Description	Format	Symbol	Example
5	antenna height inches	Antenna height in inches. Will be combined with the <i>antenna height feet</i> field.  Cannot be combined with the <i>antenna height meters</i> field.	Integer	x	,1
6	antenna height meters	Antenna height in meters.  Cannot be combined with the <i>antenna height feet</i> and <i>antenna height inches</i> fields.	Float	x.x	,2.2
7	*hh	NMEA check sum.		*hh	*78
8	[CR][LF]	Sentence terminator.			[CR][LF]



For more information about configuring the Terrain Compensation feature using the \$PMDT command, see [Configuring Terrain Compensation using NMEA Command](#) in the [SMART7 Installation and Operation User Manual](#).

2.75 POSAVE

Implements base station position averaging

Platform: OEM719, OEM729, OEM7500, OEM7600, OEM7700, OEM7720, PwrPak7, SPAN CPT7, SMART7, SMART2

This command implements position averaging for base stations. Position averaging continues for a specified number of hours or until the estimated averaged position error is within specified accuracy limits. Averaging stops when the time limit or the horizontal standard deviation limit or the vertical standard deviation limit is achieved. When averaging is complete, the **FIX POSITION** command is automatically invoked. See the **FIX** command on page 124.

If differential logging is initiated, then issue the **POSAVE** command followed by the **SAVECONFIG** command (see page 262). The receiver averages positions after every power on or reset. It then invokes the **FIX POSITION** command to enable it to send differential corrections.

Message ID: 173

Abbreviated ASCII Syntax:

```
POSAVE state [maxtime [maxhstd [maxvstd]]]
```

Factory Default:

```
POSAVE off
```

ASCII Example 1:

```
POSAVE on 24 1 2
```

ASCII Example 2:

```
POSAVE OFF
```

Field	Field Type	ASCII Value	Binary Value	Description	Format	Binary Bytes	Binary Offset
1	POSAVE header	-	-	Command header. See <i>Messages</i> on page 27 for more information.	-	H	0
2	state	ON	1	Enable position averaging	Enum	4	H
		OFF	0	Disable position averaging			
3	maxtime	0.01 - 100 hours		Maximum amount of time that positions are to be averaged (default=0.01)	Float	4	H+4
4	maxhstd	0 - 100 m		Desired horizontal standard deviation (default = 0.0)	Float	4	H+8
5	maxvstd	0 - 100 m		Desired vertical standard deviation (default = 0.0)	Float	4	H+12



The **POSAVE** command can be used to establish a new base station, in any form of survey or RTK data collection, by occupying a site and averaging the position until either a certain amount of time has passed or position accuracy has reached a user-specified level. User-specified requirements can be based on time or horizontal or vertical quality of precision.

2.76 POSTIMEOUT

Sets the position time out

Platform: OEM719, OEM729, OEM7500, OEM7600, OEM7700, OEM7720, PwrPak7, SPAN CPT7, SMART7, SMART2

This command is used to set the time out value for the position calculation in seconds.

In position logs, for example **BESTPOS** log (see page 371) or **PSRPOS** log (see page 585), when the position time out expires, the Position Type field is set to NONE. Other field values in these logs remain populated with the last available position data. Also, the position is no longer used in conjunction with the almanac to determine what satellites are visible.

Message ID: 612

Abbreviated ASCII Syntax:

```
POSTIMEOUT sec
```

Factory Default:

```
POSTIMEOUT 600
```

ASCII Example:

```
POSTIMEOUT 1200
```



When performing data collection in a highly dynamic environment (for example, urban canyons or in high speed operations), you can use **POSTIMEOUT** to prevent the receiver from outputting calculated positions that are too old. Use **POSTIMEOUT** to force the receiver position type to NONE. This ensures that the position information being used in the **BESTPOS** log (see page 371) or **PSRPOS** log (see page 585) is based on a recent calculation. All position calculations are then recalculated using the most recent satellite information.

Field	Field Type	ASCII Value	Binary Value	Description	Format	Binary Bytes	Binary Offset
1	POSTIMEOUT header	-	-	Command header. See <i>Messages</i> on page 27 for more information.	-	H	0
2	sec	0-86400		Time out in seconds	Ulong	4	H

2.77 PPPBASICCONVERGEDCRITERIA

Configures decision for PPP Basic convergence

Platform: OEM719, OEM729, OEM7500, OEM7600, OEM7700, OEM7720, PwrPak7, SPAN CPT7, SMART7, SMART2

The **PPPBASICCONVERGEDCRITERIA** command sets the threshold that determines if the solution has converged for lower accuracy PPP solutions. These are the PPP solutions reported with the PPP_BASIC and PPP_BASIC_CONVERGING position types.



The convergence threshold for high-accuracy PPP solutions (reported with PPP and PPP_CONVERGING position types) is set using the **PPPCONVERGEDCRITERIA** command (see page 215).



Relaxing the convergence threshold shortens the time before a PPP solution is reported as converged. However, it does not alter solution behavior. During the initial PPP solution period, the positions can have decimeter error variation. Only relax the convergence threshold if the application can tolerate higher solution variability.

Message ID: 1949

Abbreviated ASCII Syntax:

```
PPPBASICCONVERGEDCRITERIA criteria tolerance
```

Factory Default:

```
PPPBASICCONVERGEDCRITERIA horizontal_stddev 0.60
```

ASCII Example:

```
PPPBASICCONVERGEDCRITERIA total_stddev 0.45
```

Field	Field Type	ASCII Value	Binary Value	Description	Format	Binary Bytes	Binary Offset
1	PPPBASIC CONVERGED CRITERIA header	-	-	Command header. See <i>Messages</i> on page 27 for more information.	-	H	0
2	Criteria	TOTAL_STDDEV	1	Use the total, 3D, standard deviation	Enum	4	H
		HORIZONTAL_STDDEV	2	Use the horizontal, 2D, standard deviation			
3	Tolerance			Tolerance (m)	Float	4	H+4

2.78 PPPCONVERGEDCRITERIA

Configures decision for PPP convergence

Platform: OEM719, OEM729, OEM7500, OEM7600, OEM7700, OEM7720, PwrPak7, SPAN CPT7, SMART7, SMART2

The **PPPCONVERGEDCRITERIA** command sets the threshold that determines if the solution has converged for high-accuracy PPP solutions. These are the PPP solutions reported with the PPP and PPP_CONVERGING position types.



The convergence threshold for lower accuracy PPP solutions (reported with PPP_BASIC and PPP_BASIC_CONVERGING position types) is set using the **PPPBASICCONVERGEDCRITERIA** command (see page 214).



Relaxing the convergence threshold shortens the time before a PPP solution is reported as converged. However, it does not alter solution behavior. During the initial PPP solution period, the positions can have decimeter error variation. Only relax the convergence threshold if the application can tolerate higher solution variability.

Message ID: 1566

Abbreviated ASCII Syntax:

```
PPPCONVERGEDCRITERIA criteria tolerance
```

Factory Default:

```
PPPCONVERGEDCRITERIA horizontal_stddev 0.32
```

ASCII Example:

```
PPPCONVERGEDCRITERIA total_stddev 0.15
```

Field	Field Type	ASCII Value	Binary Value	Description	Format	Binary Bytes	Binary Offset
1	PPP CONVERGED CRITERIA header	-	-	Command header. See <i>Messages</i> on page 27 for more information.	-	H	0
2	Criteria	TOTAL_STDDEV	1	Use the total, 3D, standard deviation	Enum	4	H
		HORIZONTAL_STDDEV	2	Use the horizontal, 2D, standard deviation			
3	Tolerance			Tolerance (m)	Float	4	H+4

2.79 PPPDYNAMICS

Sets the PPP dynamics mode

Platform: OEM719, OEM729, OEM7500, OEM7600, OEM7700, OEM7720, PwrPak7, SPAN CPT7, SMART7, SMART2

This command configures the dynamics assumed by the PPP filter. AUTO detects the antenna dynamics and adapts filter operation accordingly.



The automatic dynamics detection may be fooled by very slow, “creeping” motion, where the antenna consistently moves less than 2 cm/s. In such cases, the mode should explicitly be set to DYNAMIC.

Message ID: 1551

Abbreviated ASCII Syntax:

```
PPPDYNAMICS mode
```

Factory Default:

```
PPPDYNAMICS dynamic
```

ASCII Example:

```
PPPDYNAMICS auto
```

Field	Field Type	ASCII Value	Binary Value	Description	Format	Binary Bytes	Binary Offset
1	PPPDYNAMICS header	-	-	Command header. See <i>Messages</i> on page 27 for more information.	-	H	0
2	Mode	AUTO	0	Automatically determines dynamics mode	Enum	4	H
		STATIC	1	Static mode			
		DYNAMIC	2	Dynamic mode			

2.80 PPPRESET

Reset the PPP filter

Platform: OEM719, OEM729, OEM7500, OEM7600, OEM7700, OEM7720, PwrPak7, SPAN CPT7, SMART7, SMART2

This command resets the PPP filter. After a reset, the PPP filter is restored to its initial state and PPP convergence will start over.



If deletion of the NVM-saved PPP seed information is also required, then a **PPPSEED CLEAR** command must be applied before the PPPRESET command. See the **PPPSEED** command on the next page.

Message ID: 1542

Abbreviated ASCII Syntax:

```
PPPRESET [Option]
```

ASCII Example :

```
PPPRESET
```

Field	Field Type	ASCII Value	Binary Value	Description	Binary Bytes	Binary Format	Binary Offset
1	PPPRESET header	-	-	Command header. See <i>Messages</i> on page 27 for more information.	-	H	0
2	Option	FILTER	1	Reset the PPP filter. This is an optional parameter. (default = FILTER)	4	Enum	H

2.81 PPPSEED

Control the seeding of the PPP filter

Platform: OEM719, OEM729, OEM7500, OEM7600, OEM7700, OEM7720, PwrPak7, SPAN CPT7, SMART7, SMART2

The **PPPSEED** command controls the seeding of the PPP filter. Accurate position seeding can accelerate PPP convergence.

PPPSEED SET is used to explicitly specify a seed position. The seed position must be in a datum consistent with the PPP corrections that will be used. For TerraStar corrections, this is ITRF2014. The **PPPSEED SET** command can only be used to give seed positions for stationary platforms.



Caution must be exercised when using **PPPSEED SET**. While a good seed position can accelerate convergence, a bad seed position hurts performance. In some cases, a bad seed can prevent a solution from ever converging to a correct position. In other cases, a bad seed might be rejected immediately. In still other cases, the filter might operate with it for a time period only to reject it later. In this case, the filter position is partially reset, with a corresponding discontinuity in the PPP position.

PPPSEED STORE and **RESTORE** are intended to simplify seeding in operations where the antenna does not move between power-down and power-up. For example, in agricultural operations a tractor might be stopped in a field at the end of a day and then re-started the next day in the same position. Before the receiver is powered-down, the current PPP position could be saved to NVM using the **PPPSEED STORE** command, and then that position applied as a seed after power-up using **PPPSEED RESTORE**.

PPPSEED AUTO automates the STORE and RESTORE process. When this option is used, the PPP filter automatically starts using the stopping position of the previous day. Additionally, in order for the receiver to recall the saved seed, the **PPPSEED AUTO** command should be saved to NVM using the **SAVECONFIG** command (see page 262).

Message ID: 1544

Abbreviated ASCII Syntax:

```
PPPSEED option [latitude] [longitude] [height] [northing_std._dev.]
[easting_std._dev.] [height_std._dev.]
```

ASCII Example:

```
PPPSEED set 51.11635322441 -114.03819311672 1064.5458 0.05 0.05 0.05
```

Field	Field Type	ASCII Value	Binary Value	Description	Format	Binary Bytes	Binary Offset
1	PPPSEED header	-	-	Command header. See <i>Messages</i> on page 27 for more information.	-	H	0

Field	Field Type	ASCII Value	Binary Value	Description	Format	Binary Bytes	Binary Offset
2	option	CLEAR	0	Resets the stored seed, and prevents any auto seeding from occurring.	Enum	4	H
		SET	1	Immediately apply the specified co-ordinates as a seed position.			
		STORE	2	Store the current PPP position in NVM for use as a future seed.			
		RESTORE	3	Retrieve and apply a seed position that was previously saved in NVM via the STORE or AUTO options.			
		AUTO	4	Automatically store and restore PPP seed positions.			
3	latitude	±90		Latitude (degrees)	Double	8	H+4
4	longitude	±180		Longitude (degrees)	Double	8	H+12
5	height	> -2000.0		Ellipsoidal height (meters)	Double	8	H+20
6	northing std. dev.			Northing standard deviation (meters)	Float	4	H+28
7	easting std. dev.			Easting standard deviation (meters)	Float	4	H+32
8	height std. dev.			Ellipsoidal height standard deviation (meters)	Float	4	H+36
9	Reserved				Float	4	H+40

2.82 PPPSOURCE

Specifies the PPP correction source

Platform: OEM719, OEM729, OEM7500, OEM7600, OEM7700, OEM7720, PwrPak7, SPAN CPT7, SMART7, SMART2

This command determines what corrections the PPP filter can use.

PPPSOURCE NONE stops any corrections from being used and immediately disables PPP.

Message ID: 1707

Abbreviated ASCII Syntax:

```
PPPSOURCE source
```

Factory Default:

```
PPPSOURCE auto
```

ASCII Example:

```
PPPSOURCE none
```

Field	Field Type	ASCII Value	Binary Value	Description	Format	Binary Bytes	Binary Offset
1	PPPSOURCE header	-	-	Command header. See <i>Messages</i> on page 27 for more information.	-	H	0
2	source	NONE	0	Reject all PPP corrections. Disable the PPP filter	Enum	4	H
		TERRASTAR	1	Only accept TerraStar PPP corrections			
		VERIPOS	2	Only accept Veripos PPP corrections			
		TERRASTAR_L	8	Only accept TerraStar-L PPP corrections			
		TERRASTAR_C	10	Only accept TerraStar-C PPP corrections			
AUTO	100	Automatically select and use the best corrections					

2.83 PPPTIMEOUT

Sets the maximum age of the PPP corrections

Platform: OEM719, OEM729, OEM7500, OEM7600, OEM7700, OEM7720, PwrPak7, SPAN CPT7, SMART7, SMART2

This command sets the maximum age of the corrections used in the PPP filter. Corrections older than the specified duration are not applied to the receiver observations and uncorrected observations are not used in the filter.

Message ID: 1560

Abbreviated ASCII Syntax:

```
PPPTIMEOUT delay
```

Factory Default:

```
PPPTIMEOUT 360
```

ASCII Example:

```
PPPTIMEOUT 120
```

Field	Field Type	ASCII Value	Binary Value	Description	Format	Binary Bytes	Binary Offset
1	PPPTIMEOUT header	-	-	Command header. See <i>Messages</i> on page 27 for more information.	-	H	0
2	delay	5 to 900 s		Maximum corrections age	Ulong	4	H

2.84 PPSCONTROL

Controls the PPS output

Platform: OEM719, OEM729, OEM7500, OEM7600, OEM7700, OEM7720, PwrPak7, SPAN CPT7, SMART7, SMART2

This command provides a method for controlling the polarity, period and pulse width of the PPS output on the OEM7. The PPS output can also be disabled using this command.



This command is used to setup the PPS signal coming from the receiver. For example, to take measurements such as temperature or pressure, in synch with your GNSS data, the PPS signal can be used to trigger measurements in other devices.

The leading edge of the 1 PPS pulse is always the trigger/reference. For example:

```
PPSCONTROL ENABLE NEGATIVE
```

generates a normally high, active low pulse with the falling edge as the reference, while:

```
PPSCONTROL ENABLE POSITIVE
```

generates a normally low, active high pulse with the rising edge as the reference.

The pulse width is user-adjustable. The adjustable pulse width feature supports triggers/systems that need longer, or shorter, pulse widths than the default to register the pulse enabling a type of GPIO line for manipulation of external hardware control lines.

The switch states allow more control over disabling/enabling the PPS. The ENABLE_FINETIME switch prevents the PPS from being enabled until FINE or FINESTEERING time status has been reached. The ENABLE_FINETIME_MINUTEALIGN switch is similar to ENABLE_FINETIME with caveat that the PPS will still not be enabled until the start of the next 60 seconds (a 1 minute modulus) after FINE or FINESTEERING time status has been reached.



If the value of a field shared with PPSCONTROL2 is changed in PPSCONTROL, the value of that field is also changed in PPSCONTROL2. For example, if the polarity is changed using the PPSCONTROL command, the polarity is also changed in PPSCONTROL2 command.

Message ID: 613

Abbreviated ASCII Syntax:

```
PPSCONTROL [switch [polarity [period [pulsewidth]]]]
```

Factory Default:

```
PPSCONTROL enable negative 1.0 1000
```

ASCII Example:

```
PPSCONTROL enable positive 0.5 2000
```

Field	Field Type	ASCII Value	Binary Value	Description	Format	Binary Bytes	Binary Offset
1	PPSCONTROL header	-	-	Command header. See <i>Messages</i> on page 27 for more information.	-	H	0
2	switch	DISABLE	0	Disable the PPS	Enum	4	H
		ENABLE	1	Enable the PPS (default)			
		ENABLE_FINETIME	2	Enable the PPS only when FINE or FINESTEERING time status has been reached			
		ENABLE_FINETIME_MINUTEALIGN	3	Enable the PPS only when FINE or FINESTEERING time status has been reached AND the start of the next 60 seconds (1 minute modulus) has occurred			
3	polarity	NEGATIVE	0	Optional field to specify the polarity of the pulse to be generated on the PPS output. (default=NEGATIVE)	Enum	4	H+4
		POSITIVE	1				
4	period	0.05, 0.1, 0.2, 0.25, 0.5, 1.0, 2.0, 3.0,...20.0		Optional field to specify the period of the pulse, in seconds (default=1.0)	Double	8	H+8
5	pulsewidth	Any positive value less than or equal to half the period		Optional field to specify the pulse width of the PPS signal in microseconds. This value should always be less than or equal to half the period. (default=1000)	Ulong	4	H+16

2.85 PSRDIFFSOURCE

Sets the pseudorange differential correction source

Platform: OEM719, OEM729, OEM7500, OEM7600, OEM7700, OEM7720, PwrPak7, SPAN CPT7, SMART7, SMART2

This command determines what differential corrections the PSR and PDP (GLIDE) filters can use.

Differential corrections can be generated from RTK corrections. **PSRDIFFSOURCE RTK** enables this, allowing the PSR and PDP solutions to benefit from RTK corrections. An RTK-capable model is not required for this capability.

PSRDIFFSOURCE NONE stops any corrections from being used; the PSR and PDP solutions will revert to being uncorrected.



All types except NONE may revert to SBAS (if enabled) or SINGLE position types.

Message ID: 493

Abbreviated ASCII Syntax:

```
PSRDIFFSOURCE type [id]
```

Factory Default:

```
PSRDIFFSOURCE AUTO ANY
```

ASCII Examples:

1. Enable only SBAS:

```
PSRDIFFSOURCE SBAS
SBASCONTROL ENABLE AUTO
```

2. Enable differential from RTCM, with a fall-back to SBAS:

```
PSRDIFFSOURCE RTCM ANY
SBASCONTROL ENABLE AUTO
```

3. Disable all corrections:

```
PSRDIFFSOURCE NONE
```

Field	Field Type	ASCII Value	Binary Value	Description	Format	Binary Bytes	Binary Offset
1	PSRDIFFSOURCE header	-	-	Command header. See <i>Messages</i> on page 27 for more information.	-	H	0
2	type	See <i>Table 41: PSRDIFFSOURCE Type</i> on the next page		Correction type	Enum	4	H

Field	Field Type	ASCII Value	Binary Value	Description	Format	Binary Bytes	Binary Offset
3	id	Char[4] or ANY		Base station ID (default = ANY)	Char[4]	8	H+4

Table 41: PSRDIFFSOURCE Type

Binary	ASCII	Description
0	RTCM	Use RTCM version 2 corrections from the given ID if available or SBAS otherwise. RTCM ID: $0 \leq \text{RTCM ID} \leq 1023$ or ANY to accept all IDs.
1	RTCA	Use RTCA corrections from the given ID if available or SBAS otherwise. RTCA ID: A four-character string containing only alpha (a-z) or numeric characters (0-9) or ANY to accept all IDs.
5	SBAS	Use SBAS corrections such as WAAS, EGNOS and MSAS in the region they are available and applicable to. There are regions that are not covered by any SBAS satellite and so the solution will revert to uncorrected. The ID is ignored for this correction type.
6	RTK	Use differential corrections that are generated from RTK corrections if available or SBAS otherwise. The correction type used is determined by the setting of the RTKSOURCE command (see page 244).
10	AUTO	Use any available correction source. If both differential and SBAS sources are available, differential will be preferred.
11	NONE	Disables all differential correction types. Solution will revert to uncorrected.

2.86 PSRDIFFSOURCE TIMEOUT

Sets pseudorange differential correction source timeout

Platform: OEM719, OEM729, OEM7500, OEM7600, OEM7700, OEM7720, PwrPak7, SPAN CPT7, SMART7, SMART2

When multiple differential correction sources are available, this command allows the user to set a time in seconds, that the receiver will wait before switching to another differential source, if corrections from the original source are lost.

Message ID: 1449

Abbreviated ASCII Syntax:

```
PSRDIFFSOURCE TIMEOUT option [timeout]
```

Factory Default:

```
PSRDIFFSOURCE TIMEOUT AUTO
```

ASCII Example:

```
PSRDIFFSOURCE TIMEOUT auto
PSRDIFFSOURCE TIMEOUT set 180
```

Field	Field Type	ASCII Value	Binary Value	Description	Format	Binary Bytes	Binary Offset
1	PSRDIFFSOURCE TIMEOUT header	-	-	Command header. See <i>Messages</i> on page 27 for more information.	-	H	0
2	option	AUTO	1	Use AUTO or SET to set the time	Enum	4	H
		SET	2				
3	timeout	0 to 3600 sec		Specify the timeout (default=0)	Ulong	4	H+4

2.87 PSRDIFFTIMEOUT

Sets maximum age of pseudorange differential data

Platform: OEM719, OEM729, OEM7500, OEM7600, OEM7700, OEM7720, PwrPak7, SPAN CPT7, SMART7, SMART2

This command is used to set the maximum age of pseudorange differential correction data to use when operating as a rover station. Received pseudorange differential correction data, older than the specified time, is ignored. This time out period also applies to differential corrections generated from RTK corrections.



The RTCA Standard for scat-i stipulates that the maximum age of differential correction messages cannot be greater than 22 seconds. Therefore, for RTCA rover users, the recommended PSRDIFF delay setting is 22.

Message ID: 1450

Abbreviated ASCII Syntax:

```
PSRDIFFTIMEOUT delay
```

Factory Default:

```
PSRDIFFTIMEOUT 300
```

ASCII Example:

```
PSRDIFFTIMEOUT 60
```

Field	Field Type	ASCII Value	Binary Value	Description	Format	Binary Bytes	Binary Offset
1	PSRDIFF TIMEOUT header	-	-	Command header. See <i>Messages</i> on page 27 for more information.	-	H	0
2	delay	2 to 1000 s		Maximum pseudorange differential age	Ulong	4	H

2.88 QZSSECUTOFF

Sets QZSS satellite elevation cutoff

Platform: OEM719, OEM729, OEM7500, OEM7600, OEM7700, OEM7720, PwrPak7, SPAN CPT7, SMART7, SMART2

This command is used to set the elevation cut-off angle for tracked QZSS satellites. The receiver does not start automatically searching for a QZSS satellite until it rises above the cut-off angle (when satellite position is known). Tracked satellites that fall below the cut-off angle are no longer tracked unless they are manually assigned (see the **ASSIGN** command on page 56).

In either case, satellites below the QZSSECUTOFF angle are eliminated from the internal position and clock offset solution computations.

This command permits a negative cut-off angle; it could be used in these situations:

- The antenna is at a high altitude, and thus can look below the local horizon
- Satellites are visible below the horizon due to atmospheric refraction



Care must be taken when using **QZSSECUTOFF** command because the signals from lower elevation satellites are traveling through more atmosphere and are therefore degraded. Use of satellites below 5 degrees is not recommended.



Use the **ELEVATIONCUTOFF** command (see page 114) to set the cut-off angle for any system.



For dual antenna receivers, this command applies to both the primary and secondary antennas.

Message ID: 1350

Abbreviated ASCII Syntax:

QZSSECUTOFF angle

Factory Default:

QZSSECUTOFF 5.0

ASCII Example

QZSSECUTOFF 10.0

Field	Field Type	ASCII Value	Binary Value	Description	Format	Binary Bytes	Binary Offset
1	QZSSECUTOFF header	-	-	Command header. See <i>Messages</i> on page 27 for more information.	-	H	0

Field	Field Type	ASCII Value	Binary Value	Description	Format	Binary Bytes	Binary Offset
2	angle	±90 degrees		Elevation cutoff angle relative to the horizon	Float	4	H

2.89 RADARCONFIG

Configure the Emulated Radar Output

Platform: OEM719, OEM729, OEM7500, OEM7600, OEM7700, OEM7720, PwrPak7, SPAN CPT7, SMART7, SMART2

Use this command to configure the Emulated Radar (ER) output.



The ER signal is output on the **VARF** or **EVENT_OUT1** pin of the receiver.

Message ID: 1878

Abbreviated ASCII Syntax:

```
RADARCONFIG switch [frequency_step [update_rate [response_mode
[threshold]]]]
```

Factory Default:

```
radarconfig disable
```

ASCII Example:

```
radarconfig enable 26.11 5hz 2 3.5
```

Field	Field Type	ASCII Value	Binary Value	Description	Format	Binary Bytes	Binary Offset
1	RADARCONFIG header	-	-	Command header. See <i>Messages</i> on page 27 for more information.	-	H	0
2	switch	DISABLE	0	Disables radar emulation	Enum	4	H
		ENABLE	1	Enables radar emulation			
3	freq_step	10.06 16.32 26.11 28.12 34.80 36.11		Frequency step per kilometer per hour. (default = 36.11 Hz/kph)	Double	8	H+4

Field	Field Type	ASCII Value	Binary Value	Description	Format	Binary Bytes	Binary Offset
4	update_rate	1HZ	1	Rate at which the output frequency is adjusted (default = 10HZ) ¹	Enum	4	H+12
		2HZ	2				
		5HZ	5				
		10HZ	10				
		20HZ	20				
5	resp_mode	See <i>Table 42: Response Modes</i> below		Specify how responsive radar emulation is to changes in velocity (Default = 500) ¹	Integer	4	H+16
6	threshold	2 to 50 kph		The speed threshold at which to switch between response mode 1000 and response mode 500. The threshold is only applicable when the response mode is set to 2. (default = 5 kph)	Double	8	H+20

Table 42: Response Modes

Mode	Description
1	Immediate. This results in the lowest latency at the cost of higher noise.
2	Automatically switch between 1000 and 500 depending on speed. When speed is below the Threshold parameter, use Response Mode 500. Otherwise, use Response Mode 1000.
500	Signal is minimally smoothed resulting in low latency but increased noise.
1000	Output signal is smoothed over a smaller window resulting in less latency than 2000 and less noise than 500.
2000	Output signal is smoothed to reduce noise at the cost of higher latency.

¹The number of samples used for smoothing depends on both the update_rate and resp_mode parameters. For instance, if the update_rate is 5 Hz and the resp_mode is 2000 ms, the number of samples used will be 10.

2.90 REFERENCESTATIONTIMEOUT

Sets timeout for removing previously stored base stations

Platform: OEM719, OEM729, OEM7500, OEM7600, OEM7700, OEM7720, PwrPak7, SPAN CPT7, SMART7

This command sets how long the receiver will retain RTK base station co-ordinates. Shorter durations might be required if the receiver is operating in a VRS RTK network that recycles base station IDs quickly.

Message ID: 2033

Abbreviated ASCII Syntax:

```
REFERENCESTATIONTIMEOUT option [timeout]
```

Factory Default:

```
REFERENCESTATIONTIMEOUT AUTO
```

ASCII Example:

```
REFERENCESTATIONTIMEOUT SET 90
```

Field	Field Type	ASCII Value	Binary Value	Description	Format	Binary Bytes	Binary Offset
1	REFERENCESTATION TIMEOUT header	-	-	Command header. See <i>Messages</i> on page 27 for more information.	-	H	0
2	option	AUTO	1	Sets the Timeout to 90 seconds ¹ The Timeout field is optional for AUTO and has no effect	Enum	4	H
		SET	2	Must set the timeout value using the Timeout field 0 is not accepted when using the SET option			
3	timeout	1 to 3600 s		Specify the time	Ulong	4	H+4

¹This behavior is subject to change.

2.91 RESET

Performs a hardware reset

Platform: OEM719, OEM729, OEM7500, OEM7600, OEM7700, OEM7720, PwrPak7, SPAN CPT7, SMART7, SMART2

This command performs a hardware reset. The receiver configuration reverts either to the factory default, if no user configuration was saved or the last **SAVECONFIG** settings. Refer to the **FRESET** command on page 127 and **SAVECONFIG** command on page 262.

The optional delay field is used to set the number of seconds the receiver is to wait before resetting.

Message ID: 18

Abbreviated ASCII Syntax:

```
RESET [delay]
```

Input Example

```
RESET 30
```



The **RESET** command can be used to erase any unsaved changes to the receiver configuration.

Unlike the **FRESET** command on page 127, the **RESET** command does not erase data stored in the NVM, such as Almanac and Ephemeris data.

Field	Field Type	ASCII Value	Binary Value	Description	Format	Binary Bytes	Binary Offset
1	RESET header	-	-	Command header. See <i>Messages</i> on page 27 for more information.	-	H	0
2	delay (0-60)			Seconds to wait before resetting (default = 0)	Ulong	4	H

2.92 RTKASSIST

Enable or disable RTK ASSIST

Platform: OEM719, OEM729, OEM7500, OEM7600, OEM7700, OEM7720, PwrPak7, SPAN CPT7, SMART7

This command enables or disables RTK ASSIST.

RTK ASSIST uses L-Band-delivered corrections to enable RTK operation to continue for extended durations if RTK corrections are lost. In order to use RTK ASSIST, a receiver with L-Band tracking capability and RTK ASSIST capability is needed. The duration of RTK ASSIST operation can be limited using the **RTKASSISTTIMEOUT** command (see page 235).

When active, RTK ASSIST is shown in the RTKPOS and BESTPOS extended solution status field (see *Table 69: Extended Solution Status* on page 378). The active status and further details on the RTK ASSIST status are available through the **RTKASSISTSTATUS** log on page 668.



For reliable RTK ASSIST performance, the RTK base station position must be within 1 meter of its true WGS84 position.

Message ID: 1985

Abbreviated ASCII Syntax:

```
RTKASSIST switch
```

Factory Default:

```
RTKASSIST enable
```

ASCII Example:

```
RTKASSIST disable
```

Field	Field Type	ASCII Value	Binary Value	Description	Format	Binary Bytes	Binary Offset
1	RTKASSIST header	-	-	Command header. See <i>Messages</i> on page 27 for more information.	-	H	0
2	switch	DISABLE	0	Disable RTK ASSIST	Enum	4	H
		ENABLE	1	Enable RTK ASSIST			

2.93 RTKASSISTTIMEOUT

Set the maximum RTK ASSIST duration

Platform: OEM719, OEM729, OEM7500, OEM7600, OEM7700, OEM7720, PwrPak7, SPAN CPT7, SMART7

This command sets how long the receiver will report an RTK solution when RTK is being maintained by RTK ASSIST. The maximum permitted duration of RTK ASSIST operation is determined by the subscription and receiver model. Values less than the subscription limit can be set using the **RTKASSISTTIMEOUT** command.



When RTK ASSIST is active, the **RTKTIMEOUT** command is disregarded. The maximum time that RTK will continue past an RTK corrections outage is controlled by **RTKASSISTTIMEOUT**.

Message ID: 2003

Abbreviated ASCII Syntax:

```
RTKASSISTTIMEOUT limit_type [limit_value]
```

Factory Default:

```
RTKASSISTTIMEOUT SUBSCRIPTION_LIMIT
```

ASCII Example:

```
RTKASSISTTIMEOUT USER_LIMIT 900
```

Field	Field Type	ASCII Value	Binary Value	Description	Format	Binary Bytes	Binary Offset
1	RTKASSIST TIMEOUT header	-	-	Command header. See <i>Messages</i> on page 27 for more information.	-	H	0
2	limit_type	SUBSCRIPTION _LIMIT	0	Use maximum permitted duration limit.	Enum	4	H
		USER_LIMIT	1	The maximum RTK ASSIST duration is user set, up to the limit permitted by the subscription and model.			
3	limit_value			Time out value in seconds. Only valid for the USER_LIMIT Limit Type.	Ulong	4	H+4

2.94 RTKDYNAMICS

Sets the RTK dynamics mode

Platform: OEM719, OEM729, OEM7500, OEM7600, OEM7700, OEM7720, PwrPak7, SPAN CPT7, SMART7

This command is used to specify how the receiver looks at the data. There are three modes: STATIC, DYNAMIC and AUTO. The STATIC mode forces the RTK software to treat the rover station as though it were stationary.

DYNAMIC mode forces the software to treat the rover as though it were in motion. If the receiver is undergoing very slow, steady motion (<2.5 cm/s for more than 5 seconds), use DYNAMIC mode (as opposed to AUTO) to prevent inaccurate results and possible resets.



For reliable performance, the antenna should not move more than 1-2 cm when in STATIC mode.

Message ID: 183

Abbreviated ASCII Syntax:

```
RTKDYNAMICS mode
```

Factory Default:

```
RTKDYNAMICS dynamic
```

ASCII Example:

```
RTKDYNAMICS static
```



Use the STATIC option to decrease the time required to fix ambiguities and reduce the amount of noise in the position solution. If STATIC mode is used when the antenna is not static, the receiver will have erroneous solutions and unnecessary RTK resets.

Field	Field Type	ASCII Value	Binary Value	Description	Format	Binary Bytes	Binary Offset
1	RTKDYNAMICS header	-	-	Command header. See <i>Messages</i> on page 27 for more information.	-	H	0
2	mode	AUTO	0	Automatically determines dynamics mode	Enum	4	H
		STATIC	1	Static mode			
		DYNAMIC	2	Dynamic mode			

2.95 RTKINTEGERCRITERIA

Report inaccurate fixed-integer RTK positions with float solution type

Platform: OEM719, OEM729, OEM7500, OEM7600, OEM7700, OEM7720, PwrPak7, SPAN CPT7, SMART7

This command forces a fixed-integer RTK position to be reported as float if the estimated solution standard deviation exceeds a threshold.

Normally, a fixed-integer solution is very accurate. However, in some rarely-occurring situations, even a fixed-integer solution can become inaccurate; for example, if the DOP is high due to satellites not being visible. In such cases, the accuracy of the RTK solution might be worse than what is customarily expected from a fixed-integer solution. The **RTKINTEGERCRITERIA** command changes the solution type of these high standard deviation integer solutions to their float equivalent. `NARROW_INT`, for instance, becomes `NARROW_FLOAT`. Depending on the `GGAQUALITY` command setting, this will also impact the NMEA GGA quality flag.

Message ID: 2070

Abbreviated ASCII Syntax:

```
RTKINTEGERCRITERIA criteria threshold
```

Factory Default:

```
RTKINTEGERCRITERIA TOTAL_STDDEV 1.0
```

ASCII Example:

```
RTKINTEGERCRITERIA HORIZONTAL_STDDEV 0.25
```

Field	Field Type	ASCII Value	Binary Value	Description	Format	Binary Bytes	Binary Offset
1	RTKINTEGER CRITERIA header	-	-	Command header. See <i>Messages</i> on page 27 for more information.	-	H	0
2	criteria	TOTAL_STDDEV	1	Test the threshold against the estimated total, 3D, standard deviation	Enum	4	H
		HORIZONTAL_STDDEV	2	Test the threshold against the estimated horizontal standard deviation			
3	threshold	0.01 m and higher		Estimated solution standard deviation (m) required for solution to be reported as integer	Float	4	H+4

2.96 RTKNETWORK

Specifies the RTK network mode

Platform: OEM719, OEM729, OEM7500, OEM7600, OEM7700, OEM7720, PwrPak7, SPAN CPT7, SMART7

Network RTK uses permanent base station installations, allowing kinematic GNSS users to achieve centimeter accuracies, without the need of setting up a GNSS base station, at a known site. This command sets the RTK network mode for a specific network. For more details on Network RTK, refer to the application note APN-041: Network RTK.

Message ID: 951

Abbreviated ASCII Syntax:

```
RTKNETWORK mode [network#]
```

Factory Default:

```
RTKNETWORK AUTO
```

Input Example:

```
RTKNETWORK imax
```

Field	Field Type	ASCII Value	Binary Value	Description	Format	Binary Bytes	Binary Offset
1	RTKNETWORK header	-	-	Command header. See <i>Messages</i> on page 27 for more information.	-	H	0
2	mode	<i>Table 43: Network RTK Mode below</i>		RTK network mode. The factory default is auto where the receiver switches to the first available network RTK source	Enum	4	H
3	network#	0 to 4294967295		Specify a number for the network (default = 0)	Ulong	4	H+4

Table 43: Network RTK Mode

Binary	ASCII	Description
0	DISABLE	Single reference station RTK mode. All received network RTK corrections are ignored.
1-4	Reserved	

Binary	ASCII	Description
5	VRS	<p>The Virtual Reference Station (VRS) or Virtual Base Station (VBS) idea introduced by Trimble, is that a base station is artificially created in the vicinity of a rover receiver. All baseline length dependent errors, such as abnormal troposphere variation, ionospheric disturbances and orbital errors, are reduced for this VRS. The rover receiving VRS information has a lower level of these errors than a distant base station. The VRS is calculated for a position, supplied by the rover during communication start up, with networking software. The VRS position can change if the rover is far away from the initial point. The format for sending the rover's position is standard NMEA format. Most rovers receive VRS data, for a calculated base station, within a couple of meters away.</p> <p>The VRS approach requires bi-directional communication for supplying the rover's position to the networking software.</p>
6	IMAX	<p>The iMAX idea, introduced by Leica Geosystems, is that networking software corrections, based on the rover's position, are calculated as with VRS. However, instead of calculating the base station observations for the provided position or another position closer to the base station, original observation information is corrected with the calculated corrections and broadcast. VRS works so that although the rover is unaware of the errors the VRS is taking care of, there still might be ionospheric remains in the base station observations. iMAX provides actual base station position information. The rover may assume the base station is at a distance and open its settings for estimation of the remaining ionospheric residuals. The iMAX method may trigger the rover to open its settings further than required, since the networking software removes at least part of the ionospheric disturbances. However, compared to VRS above, this approach is safer since it notifies the rover when there might be baseline length dependent errors in the observation information. iMAX requires bi-directional communication to the networking software for supplying the base station observation information.</p>
7	FKP	<p>The FKP method delivers the information from a base station network to the rover. No precise knowledge of the rover's position is required for providing the correct information. The corrections are deployed as gradients to be used for interpolating to the rover's actual position.</p>
8	MAX	<p>The basic principle of the master-auxiliary concept is to provide, in compact form, as much of the information from the network and the errors it is observing to the rover as possible. With more information about the state and distribution of the dispersive and non-dispersive errors across the network, the rover is able to use more intelligent algorithms in the determination of its position solution. Each supplier of reference station software will have their own proprietary algorithms for modeling or estimating these error sources. The rover system can decide to use or to neglect the network RTK information, depending on its own firmware algorithm performance.</p>
9	Reserved	

Binary	ASCII	Description
10	AUTO	Default value, assume single base. If network RTK corrections are detected then the receiver will switch to the appropriate mode. iMAX and VRS can only be detected using RTCMV3, however, it is not possible to distinguish between iMAX or VRS. If iMAX or VRS is detected, then iMAX will be assumed.

2.97 RTKPORTMODE

Assigns the port for RTK and ALIGN messages

Platform: OEM719, OEM729, OEM7500, OEM7600, OEM7700, OEM7720, PwrPak7, SPAN CPT7, SMART7



This command only applies to receivers with both RTK and ALIGN enabled.

A rover receiver with RTK and ALIGN enabled can receive RTK and ALIGN corrections at the same time. However, the two different sources (RTK and ALIGN) must be sent to different ports.

Use the RTKPORTMODE command to route correction feeds to different ports. RTK and ALIGN can be routed to any user specified ports.

Failing to specify the mode for the incoming source could cause unexpected behavior of RTK or ALIGN.



Ports configured using the RTKPORTMODE command must also be configured using the **INTERFACEMODE** command (see page 148).

Message ID: 1936

Abbreviated ASCII Syntax:

```
RTKPORTMODE [port] mode
```

Factory Default:

```
RTKPORTMODE COM1 RTK
RTKPORTMODE COM2 RTK
RTKPORTMODE COM3 RTK
RTKPORTMODE COM4 RTK
RTKPORTMODE COM5 RTK
RTKPORTMODE COM6 RTK
RTKPORTMODE ICOM1 RTK
RTKPORTMODE ICOM2 RTK
RTKPORTMODE ICOM3 RTK
RTKPORTMODE ICOM4 RTK
RTKPORTMODE ICOM5 RTK
RTKPORTMODE ICOM6 RTK
RTKPORTMODE ICOM7 RTK
RTKPORTMODE NCOM1 RTK
RTKPORTMODE NCOM2 RTK
RTKPORTMODE NCOM3 RTK
RTKPORTMODE USB1 RTK
```

```

RTKPORTMODE USB2 RTK
RTKPORTMODE USB3 RTK
RTKPORTMODE WCOM1 RTK
RTKPORTMODE BT1 RTK
RTKPORTMODE AUX RTK
RTKPORTMODE CCOM1 RTK
RTKPORTMODE CCOM2 RTK
RTKPORTMODE CCOM3 RTK
RTKPORTMODE CCOM4 RTK
RTKPORTMODE CCOM5 ALIGN
RTKPORTMODE CCOM6 RTK
    
```

ASCII Example:

```

RTKPORTMODE COM2 RTK
RTKPORTMODE COM3 ALIGN
    
```

Field	Field Type	ASCII Value	Binary Value	Description	Format	Binary Bytes	Binary Offset
1	RTKPORTMODE header	-	-	Command header. See <i>Messages</i> on page 27 for more information.	-	H	0
2	Port	See <i>Table 25: Communications Port Identifiers</i> on page 110		Port identifier (default = THISPORT)	Enum	4	H
3	Mode	RTK	0	Mode for this port	Enum	4	H+4
		ALIGN	1				

2.98 RTKRESET

Reset the RTK filter

Platform: OEM719, OEM729, OEM7500, OEM7600, OEM7700, OEM7720, PwrPak7, SPAN CPT7, SMART7

This command resets the RTK filter and causes the AdVanceRTK filter to undergo a complete reset, forcing the system to restart the ambiguity resolution calculations.

Message ID: 2082

Abbreviated ASCII Syntax:

```
RTKRESET [Switch]
```

Example :

```
RTKRESET
```

Field	Field Type	ASCII Value	Binary Value	Description	Format	Binary Byte	Binary Offset
1	RTKRESET header	-	-	Command header. See <i>Messages</i> on page 27 for more information.	-	H	0
2	Switch	FILTER	1	Reset the RTK filter. This is an optional parameter	Enum	4	H

2.99 RTKSOURCE

Sets the RTK correction source

Platform: OEM719, OEM729, OEM7500, OEM7600, OEM7700, OEM7720, PwrPak7, SPAN CPT7, SMART7

This command determines what corrections the RTK filter can use. This is useful when the receiver is receiving corrections from multiple base stations.

RTKSOURCE NONE stops any corrections from being used and immediately disables RTK and RTK-ASSIST.

Message ID: 494

Abbreviated ASCII Syntax:

```
RTKSOURCE type [id]
```

Factory Default:

```
RTKSOURCE AUTO ANY
```

ASCII Examples:

1. Use a specific format:

```
RTKSOURCE RTCMV3
```

2. Use a specific format and base station:

```
RTKSOURCE RTCMV3 1234
```

3. Disable RTK:

```
RTKSOURCE NONE
```

Field	Field Type	ASCII Value	Binary Value	Description	Format	Binary Bytes	Binary Offset
1	RTKSOURCE header	-	-	Command header. See <i>Messages</i> on page 27 for more information.	-	H	0
2	type	See <i>Table 44: RTK Source Type</i> below		Correction type	Enum	4	H
3	id	Char[4] or ANY		Base station ID (default = ANY)	Char[4]	8	H+4

Table 44: RTK Source Type

Binary	ASCII	Description
0	RTCM	Use only RTCM version 2 corrections from the given ID. ID: $0 \leq \text{RTCM ID} \leq 1023$ or ANY to accept all IDs

Binary	ASCII	Description
1	RTCA	Use only RTCA corrections from the given ID. ID: A four-character string containing only alpha (a-z) or numeric characters (0-9) or ANY to accept all IDs
2	CMR	Use only CMR corrections from the given ID. ID: $0 \leq \text{CMR ID} \leq 31$ or ANY to accept all IDs
10	AUTO	Use any correction type received. If multiple types are received, the first one received is used. If entered, the ID must be ANY.
11	NONE	Disable RTK
13	RTCMV3	Use only RTCM version 3 corrections from the given ID. ID: $0 \leq \text{RTCMV3 ID} \leq 4095$ or ANY to accept all IDs.
14	NOVATELX	Use only NovAtel proprietary corrections from the given ID. ID: A four-character string containing alpha (a-z) or numeric characters (0-9) or ANY to accept all IDs.

2.100 RTKSOURCETIMEOUT

Sets RTK correction source timeout

Platform: OEM719, OEM729, OEM7500, OEM7600, OEM7700, OEM7720, PwrPak7, SPAN CPT7, SMART7

When multiple RTK correction sources are available, this command allows the user to set a time, in seconds, that the receiver will wait before switching to another RTK correction source if corrections from the original source are lost.

Message ID: 1445

Abbreviated ASCII Syntax:

```
RTKSOURCETIMEOUT option [timeout]
```

Factory Default:

```
RTKSOURCETIMEOUT AUTO
```

ASCII Example:

```
RTKSOURCETIMEOUT auto
RTKSOURCETIMEOUT set 180
```

Field	Field Type	ASCII Value	Binary Value	Description	Format	Binary Bytes	Binary Offset
1	RTKSOURCE TIMEOUT header	-	-	Command header. See <i>Messages</i> on page 27 for more information.	-	H	0
2	option	AUTO	1	Sets the timeout according to network type or other self-detected conditions. Timeout field is optional for AUTO and has no effect	Enum	4	H
		SET	2	Sets the timeout to the value entered in the <i>timeout</i> field.			
3	timeout	1 to 3600 s (maximum)		Specify the time 0 is not accepted if <i>SET</i> is entered in the <i>option</i> field (default=0 for the AUTO option)	Ulong	4	H+4

2.101 RTKSVENTRIES

Sets number of satellites in corrections

Platform: OEM719, OEM729, OEM7500, OEM7600, OEM7700, OEM7720, PwrPak7, SPAN CPT7, SMART7

This command sets the number of satellites (at the highest elevation) that are transmitted in the RTK corrections from a base station receiver. This is useful when the amount of bandwidth available for transmitting corrections is limited.

Message ID: 92

Abbreviated ASCII Syntax:

```
RTKSVENTRIES number
```

Factory Default:

```
RTKSVENTRIES 24
```

ASCII Example:

```
RTKSVENTRIES 7
```



GPS devices have enabled many transit and fleet authorities to provide Automatic Vehicle Location (AVL). AVL systems track the position of individual vehicles and relay that data back to a remote dispatch location that can store or better utilize the information. Consider the implementation of an AVL system within a police department, to automatically log and keep track of the location of each cruiser. Typically a fleet uses a 9600 bps connection where AVL data is relayed back to headquarters. The limited bandwidth of the radio must be shared amongst the AVL and other systems in multiple cruisers.

When operating with a low baud rate radio transmitter (9600 or lower), especially over a long distance, the AVL system could limit the number of satellites for which corrections are sent using the **RTKSVENTRIES** command.

Field	Field Type	ASCII Value	Binary Value	Description	Format	Binary Bytes	Binary Offset
1	RTKSVENTRIES header	-	-	Command header. See <i>Messages</i> on page 27 for more information.	-	H	0
2	number	4-24		The number of SVs to be transmitted in correction messages	Ulong	4	H

2.102 RTKTIMEOUT

Sets maximum age of RTK data

Platform: OEM719, OEM729, OEM7500, OEM7600, OEM7700, OEM7720, PwrPak7, SPAN CPT7, SMART7

This command is used to set the maximum age of RTK data to use when operating as a rover station. RTK data received that is older than the specified time is ignored.



When RTK ASSIST is active, the **RTKTIMEOUT** command is disregarded. The maximum time that RTK will continue past an RTK corrections outage is controlled by the settings in the **RTKASSISTTIMEOUT** command (see page 235).

Message ID: 910

Abbreviated ASCII Syntax:

```
RTKTIMEOUT delay
```

Factory Default:

```
RTKTIMEOUT 60
```

ASCII Example (rover):

```
RTKTIMEOUT 20
```

Field	Field Type	ASCII Value	Binary Value	Description	Format	Binary Bytes	Binary Offset
1	RTKTIMEOUT header	-	-	Command header. See <i>Messages</i> on page 27 for more information.	-	H	0
2	delay	5 to 60 s		Maximum RTK data age	Ulong	4	H

2.103 SATEL4CONFIG

Configures the Satel 400 MHz radio

Platform: SMART7 with RELAY7



Refer to the Satel Radio user documentation for complete and detailed instructions regarding the correct operation of the radio.

This command is used to configure the Satel 400 MHz radio. Settings in this command are stored directly on the radio and not saved through the **SAVECONFIG** command on page 262.

The receiver responds to the command immediately, but the radio settings will take some time to be applied. Log **SATELSTATUS** `onchanged` to receive a notification that configuration is complete. See the **SATELSTATUS** log on page 710.



- Not all compatibility modes are available on every radio.
- The `radio_behavior` setting determines whether the receive or transmit frequency will be changed.
- If the TRIMTALK protocol is used, the base transmitter type (TRIMBLE or PACCREST) must be specified.
- If the `tx_power` value entered does not correspond to one of the power levels supported by the radio module, the output power is set to the nearest possible value.



Do not interrupt power while the radio is being configured.

Message ID: 2215

Abbreviated ASCII Syntax:

```
SATEL4CONFIG <radio_behavior> <tx_power> <freq> <compatibility> <base_type>
```

ASCII Example:

```
SATEL4CONFIG RX 0 438000000 7 TRIMBLE
```

Field	Field Type	ASCII Value	Binary Value	Description	Format	Binary Bytes	Binary Offset
1	SATEL4CONFIG header	-	-	Command header. See <i>Messages</i> on page 27 for more information.	-	H	0
2	radio_behavior	Refer to <i>Table 45: Radio Behavior</i> on the next page		Radio behavior	ENUM	4	H

Field	Field Type	ASCII Value	Binary Value	Description	Format	Binary Bytes	Binary Offset
3	tx_power	0 - 35000		Transmit power (mW)	UINT	4	H+4
4	frequency	403000000 - 473000000		Frequency (Hz)	UINT	4	H+8
5	compatibility mode	1-20 Refer to <i>Table 46: Compatibility Mode</i> on the next page		Radio compatibility mode	UINT	4	H+12
6	base type	0-5 Refer to <i>Table 47: Base Type</i> on the next page		Base transmitter type (required for TRIMTALK protocol only)	ENUM	4	H+16
7	crc			32-bit CRC (ASCII and Binary only)	Hex	4	H+20

Table 45: Radio Behavior

Binary	ASCII	Description
0	RX	Configure for receive
1	TX	Configure for transmit

Table 46: Compatibility Mode

Binary	Protocol	Modulation	Link Rate (bps) / Channel Spacing (kHz)	FEC
1	Pacific Crest compatible	GMSK	4800 / 12.5	ON
2	Pacific Crest compatible	GMSK	4800 / 12.5	OFF ¹
3	Pacific Crest compatible	4FSK	9600 / 12.5	ON
4	Pacific Crest compatible	4FSK	9600 / 12.5	OFF ¹
5	Pacific Crest FST compatible	4FSK	9600 / 12.5	ON
6	Pacific Crest FST compatible	4FSK	9600 / 12.5	OFF ¹
7	Trimtalk compatible	GMSK	4800 / 12.5	
8	Trimtalk compatible	GMSK	8000 ²	
9	Satel 3AS	4FSK	9600 / 12.5	ON
10	Satel 3AS	4FSK	9600 / 12.5	OFF
11	Pacific Crest compatible	GMSK	9600 / 25.0	ON
12	Pacific Crest compatible	GMSK	9600 / 25.0	OFF ¹
13	Pacific Crest compatible	4FSK	19200 / 25.0	ON
14	Pacific Crest compatible	4FSK	19200 / 25.0	OFF ¹
15	Pacific Crest FST compatible	4FSK	19200 / 25.0	ON
16	Pacific Crest FST compatible	4FSK	19200 / 25.0	OFF ¹
17	Trimtalk compatible	GMSK	9600/ 25.0	
18	Trimtalk compatible	GMSK	16000 ²	
19	Satel 3AS	4FSK	19200 / 25.0	ON
20	Satel 3AS	4FSK	19200 / 25.0	OFF

Table 47: Base Type

Binary	ASCII	Description
0	PACCREST	PacCrest transmitter
4	TRIMBLE	Trimble transmitter
9	NONE	Unspecified base type

¹The Satel M3-R4 and EASy radio modules do not support disabling FEC for compatibility modes.

²The Satel M3-R4 and EASy radio modules do not support Trimtalk 8000 and 16000 link rates.



Base Type is only required for receiving TRIMTALK protocol.

2.104 SATEL9CONFIG

Configures the Satel 900 MHz radio

Platform: SMART7 with RELAY7



Refer to the Satel Radio user documentation for complete and detailed instructions regarding the correct operation of the radio.

This command is used to configure the Satel 900 MHz radio. Settings in this command are stored directly on the radio and not saved through the **SAVECONFIG** command on page 262. Commands can be sent immediately after each other with the last command issued is applied.

Log **SATELSTATUS** *onchanged* to send a notification configuration is complete. See the **SATELSTATUS** log on page 710.



If modem mode is set to P2MP_SLAVE or P2MP_RX_SLAVE , the receive frequency is changed.
If modem mode is set to P2MP_MASTER, the transmit frequency is changed.



Do not interrupt power while the radio is being configured.

Message ID: 2217

Abbreviated ASCII Syntax:

```
SATEL9CONFIG <modem_mode> <freq_key> <nid> <minpkt> <maxpkt> <retrytimeout>
<subnet> <repeaters> <masterpacketrepeat> <txpwr>
```

ASCII Example:

```
SATEL9CONFIG P2MP_MASTER 1 4024 8 9 10 00 TRUE 1 1000
SATEL9CONFIG P2MP_RX_SLAVE 1 4024 8 9 10 00 FALSE 1 0
```

Field	Field Type	ASCII Value	Binary Value	Description	Format	Binary Bytes	Binary Offset
1	SATEL9CONFIG header	-	-	Command header. See <i>Messages</i> on page 27 for more information.	-	H	0

Field	Field Type	ASCII Value	Binary Value	Description	Format	Binary Bytes	Binary Offset
2	modem_mode	P2MP_MASTER	2	Radio role in the network	Enum	4	H
		P2MP_SLAVE	3				
		P2MP_RX_SLAVE	8				
3	freq_key	0-14		Frequency key for hop table	Uint	4	H+4
4	nid	0-4095		Network ID	Uint	4	H+8
5	minpkt	0-9		Minimum packet size	Uint	4	H+12
6	maxpkt	0-9		Maximum packet size	Enum	4	H+16
7	retrytimeout	8-255		Number of failed attempts to receive packets before connection drops	Uint	4	H+20
8	subnet	0x00, 0xFF		Multi-point subnet 0x00=Roaming 0xFF=Disabled	Uint	4	H+24
9	repeaters	FALSE	0	Boolean to specify if repeaters are present in the network	Bool	4	H+28
		TRUE	1				
10	masterpacketrepeat	0-9		Number of times the master repeats packets	Uint	4	H+32
11	txpwr	0-1000		Transmitter output power (mW)	Uint	4	H+36
12	crc			32-bit CRC (ASCII and Binary only)	Hex	4	H+40

2.105 SATEL9CONFIGL

Configures the 900 MHz radio network

Platform: SMART7 with RELAY7

The SATEL9CONFIGL command is used to configure the Satel 900 MHz radio network settings using a simplified Leica channel identifier.

Message ID: 2218

Abbreviated ASCII Syntax:

```
SATEL9CONFIGL <modem_mode> <channel> <retrytimeout> <subnet> <repeaters>
<masterpacketrepeat> <txpwr>
```

ASCII Example:

```
SATEL9CONFIGL P2MP_MASTER 2 10 00 TRUE 1 1000
SATEL9CONFIGL P2MP_RX_SLAVE 4 10 FF FALSE 0 0
```

Field	Field Type	ASCII Value	Binary Value	Description	Format	Binary Bytes	Binary Offset
1	SATEL9CONFIGL header	-	-	Command header. See <i>Messages</i> on page 27 for more information.	-	H	0
2	modem_mode	P2MP_MASTER	2	Radio roll in network	Enum	4	H
		P2MP_SLAVE	3				
		P2MP_RX_SLAVE	8				
3	channel	1-9		Virtual channel	Uint	4	H+4
4	retrytimeout	8-255		Number of failed attempts to receive packets before connection is dropped	Uint	4	H+8
5	subnet	0x00, 0xFF		Multi-point subnet 0x00=Roaming, 0xFF=Disabled	Uint	4	H+12

Field	Field Type	ASCII Value	Binary Value	Description	Format	Binary Bytes	Binary Offset
6	repeaters	FALSE	0	Boolean to specify if repeaters are present in the network	Bool	4	H+16
		TRUE	1				
7	masterpacketrepeat	0-9		Number of times master repeats packets	Uint	4	H+20
8	txpwr	0-1000		Transmitter output power (mW)	Uint	4	H+24
9	crc			32-bit CRC (ASCII and Binary only)	Hex	4	H+28

2.106 SATEL9CONFIGN

Configures the 900 MHz radio network

Platform: SMART7 with RELAY7

The SATEL9CONFIGN command is used to configure the Satel 900 MHz radio network settings using a simplified Novariant channel identifier.

Message ID: 2219

Abbreviated ASCII Syntax:

```
SATEL9CONFIGN <modem_mode> <channel> <retrytimeout> <subnet> <repeaters>
<masterpacketrepeat> <txpwr>
```

ASCII Example:

```
SATEL9CONFIGN P2MP_MASTER 32 10 00 TRUE 1 1000
SATEL9CONFIGN P2MP_RX_SLAVE 32 10 00 FALSE 0 0
```

Field	Field Type	ASCII Value	Binary Value	Description	Format	Binary Bytes	Binary Offset
1	SATEL9CONFIGN header	-	-	Command header. See <i>Messages</i> on page 27 for more information.	-	H	0
2	modem_mode	P2MP_MASTER	2	Radio roll in network	Enum	4	H
		P2MP_SLAVE	3				
		P2MP_RX_SLAVE	8				
3	channel	1-3824		Virtual channel	Uint	4	H+4
4	retrytimeout	8-255		Number of failed attempts to receive packets before connection is dropped	Uint	4	H+8
5	subnet	0x00, 0xFF		Multi-point subnet 0x00=Roaming, 0xFF=Disabled	Uint	4	H+12

Field	Field Type	ASCII Value	Binary Value	Description	Format	Binary Bytes	Binary Offset
6	repeaters	FALSE	0	Boolean to specify if repeaters are present in the network	Bool	4	H+16
		TRUE	1				
7	masterpacketrepeat	0-9		Number of times master repeats packets	Uint	4	H+20
8	txpwr	0-1000		Transmitter output power (mW)	Uint	4	H+24
9	crc			32-bit CRC (ASCII and Binary only)	Hex	4	H+28

2.107 SATELCONTROL

Controls radio operations

Platform: SMART7 with RELAY7

The SATELCONTROL command is used to control the SATEL radio.

Message ID: 2203

Abbreviated ASCII Syntax:

```
SATELCONTROL <Action> <Value>
```

ASCII Example:

```
SATELCONTROL POWER ON
```

Field	Field Type	ASCII Value	Binary Value	Description	Format	Binary Bytes	Binary Offset
1	SATEL CONTROL header	-	-	Command header. See <i>Messages</i> on page 27 for more information.	-	H	0
2	action	Refer to <i>Table 48: Turn Radio On, Off or Factory Reset</i> below		Action to perform	Enum	4	H
	value			Corresponding value for action	String [24] ¹	24	H+4
3	crc			32-bit CRC (ASCII and Binary only)	Hex	4	H+28

Table 48: Turn Radio On, Off or Factory Reset

Action	Value	Description
POWER	ON	Toggles radio power (if available)
	OFF	
FRESET	-	Resets the radio to factory default settings

¹Refer to *Table 1: Field Type* on page 27 for detailed explanation of string variable length.

2.108 SATELDETECT

Detects the connected Satel radio

Platform: SMART7 with RELAY7

This command is used to detect the Satel radio connected to the serial port. Detection is only required to configure the radio settings. If previously configured, the radio can provide RTK corrections without issuing the SATELDETECT command.

Logging **SATELSTATUS** command on page 710 onchanged provides a notification of the completion of detection. If no radio is detected at the default baud rate of 38400, the RIL will attempt at additional baud rates (115200, 9600). If a radio is detected, the baud rate of the radio will be changed to 38400. Upon detection, the radio identity (version block) and settings (**SATEL4INFO** command on page 705 and **SATEL9INFO** command on page 707) will be queried. Regardless of the presence of a radio, the final state of the given serial port will be baud rate=38400, data bits=8, parity bits=N, stop bits=1. Interfacemode will be returned to its setting before SATELDETECT was issued.

Message ID: 2204

Abbreviated ASCII Syntax:

```
SATELDETECT COMPort
```

ASCII Example:

```
SATELDETECT COM3
```

Field	Field Type	ASCII Value	Binary Value	Description	Format	Binary Bytes	Binary Offset
1	SATELDETECT header	-	-	Command header. See <i>Messages</i> on page 27 for more information.	-	H	0
2	port	See <i>Table 51: COM Port Identifiers</i> on page 278		Port to attempt detection (default=COM3)	Enum	4	H

2.109 SATELSTARTUPDETECT

Detects the Satel radio on the COM port during startup

Platform: SMART7 with RELAY7

This command is used to detect the Satel radio connected to the COM port during system startup. Detection functions the same as if the **SATELDETECT** command on the previous page was issued. SATELDETECT automatically begins at the next startup when the **SATELSTARTUPDETECT** command is used.

The **SAVECONFIG** command on the next page must be issued to set this command parameters.

Message ID: 2221

Abbreviated ASCII Syntax:

```
SATELSTARTUPDETECT Switch COMPort
```

ASCII Example:

```
SATELSTARTUPDETECT Enable COM3
```

Field	Field Type	ASCII Value	Binary Value	Description	Format	Binary Bytes	Binary Offset
1	SATELSTARTUP DETECT header	-	-	Command header. See <i>Messages</i> on page 27 for more information.	-	H	0
2	switch	Enable	-	Switch to enable detection (default=Disable)	Enum	4	H
		Disable	-				
3	port	See <i>Table 51: COM Port Identifiers</i> on page 278		Port to attempt detection (default=COM3)	Enum	4	H+4

2.110 SAVECONFIG

Save current configuration in NVM

Platform: OEM719, OEM729, OEM7500, OEM7600, OEM7700, OEM7720, PwrPak7, SPAN CPT7, SMART7, SMART2

SAVECONFIG saves commands that were entered by a user to establish the desired receiver configuration on start up. This configuration is saved in Non-Volatile Memory (NVM) and is executed every time the receiver starts, whether by power-up or the **RESET** command on page 233. The commands that are saved as part of a configuration are typically **LOG** requests, **SERIALCONFIG** commands, **ICOMCONFIG** commands, a **FIX** command and others. Note that not all the commands can be saved using **SAVECONFIG**. All of the commands that set a configuration, including default commands for the receiver, are listed in the **RXCONFIG** log (see page 684). To clear the commands saved by **SAVECONFIG** and reset the receiver to the factory-set configuration, the **FRESET** command on page 127 can be used.



If using the **SAVECONFIG** command in NovAtel Connect, ensure that you have all windows other than the Console window closed. Otherwise, log requests used for the various windows are saved as well. This will result in unnecessary data being logged.

Message ID: 19

Abbreviated ASCII Syntax:

SAVECONFIG

Field	Field Type	ASCII Value	Binary Value	Description	Format	Binary Bytes	Binary Offset
1	SAVECONFIG header	-	-	Command header. See <i>Messages</i> on page 27 for more information.	-	H	0

2.111 SAVEETHERNETDATA

Save the configuration data associated with an Ethernet interface

Platform: OEM729, OEM7600, OEM7700, OEM7720, PwrPak7, SPAN CPT7, SMART7-I, SMART7-SI

Saving the configuration data for an Ethernet interface allows the interface to start automatically at boot time and be configured with either a static IP address or to obtain an address using DHCP. The **SAVEETHERNETDATA** command saves the configuration for the interface previously entered using the **ETHCONFIG** command (see page 117), **IPCONFIG** command (see page 154) and **DNSCONFIG** command (see page 106). The configuration data that is saved will survive a **RESET** command (see page 233) and **FRESET** command (see page 127). To clear the Ethernet interface configuration data, the **FRESET ETHERNET** command is used. It is not necessary to issue the **SAVECONFIG** command (see page 262) to save the Ethernet interface configuration data. In fact, if **SAVECONFIG** is used to save the **ETHCONFIG**, **IPCONFIG** and **DNSCONFIG** commands, the configuration saved by **SAVEETHERNETDATA** will take precedence over the **SAVECONFIG** configuration.

Message ID: 1679

Abbreviated ASCII Syntax:

```
SAVEETHERNETDATA [Interface]
```

ASCII Example:

```
ETHCONFIG ETHA AUTO AUTO AUTO AUTO
IPCONFIG ETHA STATIC 192.168.8.11 255.255.255.0 192.168.8.1
DNSCONFIG 1 192.168.4.200
SAVEETHERNETDATA ETHA
```

Field	Field Type	ASCII Value	Binary Value	Description	Format	Binary Bytes	Binary Offset
1	SAVEETHERNET DATA header	-	-	Command header. See <i>Messages</i> on page 27 for more information.	-	H	0
2	Interface	ETHA	2	The Ethernet interface to save the configuration data for. The default is ETHA.	Enum	4	H

Note that the configurations set using the **ICOMCONFIG** command (see page 146) and **NTRIPCONFIG** command (see page 199) are not saved by the **SAVEETHERDATA** command. The following factory default ICOM configurations can be used if Ethernet access to the receiver is required immediately after the receiver is **RESET** or **FRESET**.

```
ICOMCONFIG ICOM1 TCP :3001
ICOMCONFIG ICOM2 TCP :3002
ICOMCONFIG ICOM3 TCP :3003
ICOMCONFIG ICOM4 TCP :3004
ICOMCONFIG ICOM5 TCP :3005
```

```
ICOMCONFIG ICOM6 TCP :3006  
ICOMCONFIG ICOM7 TCP :3007
```

See also the following commands:

- **ETHCONFIG** command on page 117
- **IPCONFIG** command on page 154
- **DNSCONFIG** command on page 106
- **FRESET** command on page 127

2.112 SBASCONTROL

Sets SBAS test mode and PRN

Platform: OEM719, OEM729, OEM7500, OEM7600, OEM7700, OEM7720, PwrPak7, SPAN CPT7, SMART7, SMART2

This command is used to dictate how the receiver tracks and uses correction data from Satellite Based Augmentation Systems (SBAS).

To enable the position solution corrections, issue the **SBASCONTROL ENABLE** command. The receiver does not, by default, attempt to track or use any SBAS signals satellites unless told to do so by the **SBASCONTROL** command. When in AUTO mode, if the receiver is outside the defined satellite system's corrections grid, it reverts to ANY mode and chooses a system based on other criteria.

The "testmode" parameter in the example provides a method to use a particular satellite even if it is currently operating in test mode. The recommended setting for tracking satellites operating in test mode is ZEROTOTWO. On a simulator, you may want to leave this parameter off or specify NONE explicitly.

When using the **SBASCONTROL** command to direct the receiver to use a specific correction type, the receiver begins to search for and track the relevant GEO PRNs for that correction type only.

The receiver can be forced to track a specific PRN using the **ASSIGN** command (see page 56). The receiver can also be forced to use the corrections from a specific SBAS PRN using the **SBASCONTROL** command.

Disable stops the corrections from being used.

Message ID: 652

Abbreviated ASCII Syntax:

```
SBASCONTROL switch [system] [prn] [testmode]
```

Factory Default:

```
SBASCONTROL disable
```

ASCII Example:

```
SBASCONTROL enable waas
```

Field	Field Type	ASCII Value	Binary Value	Description	Format	Binary Bytes	Binary Offset
1	SBASCONTROL header	-	-	Command header. See <i>Messages</i> on page 27 for more information.	-	H	0

Field	Field Type	ASCII Value	Binary Value	Description	Format	Binary Bytes	Binary Offset
2	switch	DISABLE	0	Receiver does not use the SBAS corrections it receives (default)	Enum	4	H
		ENABLE	1	Receiver uses the SBAS corrections it receives			
3	system	See Table 49: System Types below		Choose the SBAS the receiver will use	Enum	4	H+4
4	prn	0		Receiver uses any PRN (default)	Ulong	4	H+8
		120-158 and 183-187		Receiver uses SBAS corrections only from this PRN			
5	testmode	NONE	0	Receiver interprets Type 0 messages as they are intended (as do not use) (default)	Enum	4	H+12
		ZEROTOTWO	1	Receiver interprets Type 0 messages as Type 2 messages			
		IGNOREZERO	2	Receiver ignores the usual interpretation of Type 0 messages (as do not use) and continues			

Table 49: System Types

ASCII	Binary	Description
NONE	0	Does not use any SBAS satellites (Default for SBASCONTROL DISABLE)
AUTO	1	Automatically determines satellite system to use and prevents the receiver from using satellites outside of the service area (Default for SBASCONTROL ENABLE)

ASCII	Binary	Description
ANY	2	Uses any and all SBAS satellites found
WAAS	3	Uses only WAAS satellites
EGNOS	4	Uses only EGNOS satellites
MSAS	5	Uses only MSAS satellites
GAGAN	6	Uses only GAGAN satellites
QZSS	7	Uses only QZSS L1S signals

2.113 SBASECUTOFF

Sets SBAS satellite elevation cut-off

Platform: OEM719, OEM729, OEM7500, OEM7600, OEM7700, OEM7720, PwrPak7, SPAN CPT7, SMART7, SMART2

This command sets the elevation cut-off angle for tracked SBAS satellites. The receiver does not start automatically searching for an SBAS satellite until it rises above the cut-off angle (when satellite position is known). Tracked SBAS satellites that fall below the cut-off angle are no longer tracked unless they are manually assigned (see the **ASSIGN** command on page 56).

This command permits a negative cut-off angle and can be used in the following situations:

- The antenna is at a high altitude and can look below the local horizon
- Satellites are visible below the horizon due to atmospheric refraction



Use the **ELEVATIONCUTOFF** command (see page 114) to set the cut-off angle for any system.

Message ID: 1000

Abbreviated ASCII Syntax:

SBASECUTOFF angle

Factory Default:

SBASECUTOFF -5.0

ASCII Example:

SBASECUTOFF 10.0

Field	Field Type	ASCII Value	Binary Value	Description	Format	Binary Bytes	Binary Offset
1	SBASECUTOFF header	-	-	Command header. See <i>Messages</i> on page 27 for more information.	-	H	0
2	angle	±90.0 degrees		Elevation cut-off angle relative to horizon	Float	4	H

2.114 SBASTIMEOUT

Sets the SBAS position time out

Platform: OEM719, OEM729, OEM7500, OEM7600, OEM7700, OEM7720, PwrPak7, SPAN CPT7, SMART7, SMART2

This command is used to set the amount of time the receiver remains in an SBAS position if it stops receiving SBAS corrections.

Message ID: 1001

Abbreviated ASCII Syntax:

```
SBASTIMEOUT mode [delay]
```

Factory Default:

```
SBASTIMEOUT auto
```

ASCII Example:

```
SBASTIMEOUT set 100
```



When the time out mode is AUTO, the time out delay is 180 s.

Field	Field Type	ASCII Value	Binary Value	Description	Format	Binary Bytes	Binary Offset
1	SBASTIMEOUT header	-	-	Command header. See <i>Messages</i> on page 27 for more information.	-	H	0
2	mode	See Table 50: <i>SBAS Time Out Mode</i> below		Time out mode	Enum	4	H
3	delay	2 to 1000 s		Maximum SBAS position age (default=180)	Double	8	H+4
4	Reserved				Double	8	H+12

Table 50: SBAS Time Out Mode

Binary	ASCII	Description
0	Reserved	
1	AUTO	Set the default value (180 s)
2	SET	Set the delay in seconds

2.115 SELECTCHANCONFIG

Sets the channel configuration

Platform: OEM719, OEM729, OEM7500, OEM7600, OEM7700, OEM7720, PwrPak7, SPAN CPT7, SMART7, SMART2

Some software models come with support for more than one channel configuration, which can be verified by logging **CHANCONFIGLIST** log (see page 395). The **SELECTCHANCONFIG** command is used to pick a different channel configuration. If a different channel configuration is selected via the **SELECTCHANCONFIG** command, the receiver resets and starts up with the new configuration. The Set in Use number in the **CHANCONFIGLIST** log (see page 395) changes as a result.



After a FRESET, the channel configuration is reset to the factory default value. For receivers with a positioning model bit of R, B or P, the default channel configuration is 3. For all other positioning models, the default is 1.

Message ID: 1149

Abbreviated ASCII Syntax:

```
SELECTCHANCONFIG chanconfigsetting
```

Factory Default:

```
SELECTCHANCONFIG 3 (if the positioning model bit is R, B or P)
```

```
SELECTCHANCONFIG 1 (for all other positioning models)
```

ASCII Example:

```
SELECTCHANCONFIG 2
```

Field	Field Type	ASCII Value	Binary Value	Description	Format	Binary Bytes	Binary Offset
1	SELECTCHANCONFIG header	-	-	Command header. See <i>Messages</i> on page 27 for more information.	-	H	0
2	chanconfigsetting	1 to n where n is the number of channel configurations in the CHANCONFIGLIST log (see page 395)		Channel configuration to use	Ulong	4	H



Below is a use case example of the **SELECTCHANCONFIG** command. Abbreviated ASCII commands and logs are used to better illustrate the example.

1. LOG CHANCONFIGLIST to show what the channel configuration options are and which channel configuration set is being used.

```
<CHANCONFIGLIST COM1 0 25.5 UNKNOWN 0 8.226 02440020 d1c0 15823
<  1 5
<    7
<   16 GPSL1L2PL5
<    4 QZSSL1CAL2CL5
<    4 SBASL1
<   14 GLOL1L2
<   16 GALE1E5B
<   22 BEIDOUB1B2
<    5 LBAND
<    7
<   16 GPSL1L2
<    4 QZSSL1CAL2C
<    4 SBASL1
<   14 GLOL1L2
<   16 GALE1E5B
<   22 BEIDOUB1B2
<    5 LBAND
<    7
<   16 GPSL1L2PL2CL5
<    4 QZSSL1CAL2CL5
<    4 SBASL1
<   14 GLOL1L2PL2C
<   16 GALE1E5AE5BALTB
<   22 BEIDOUB1B2
<    5 LBAND
<    8
<   16 GPSL1L2PL2CL5
<    4 QZSSL1CAL2CL5
<    4 SBASL1L5
<   14 GLOL1L2PL2C
<   16 GALE1E5AE5BALTB
<   20 BEIDOUB1B1CB2B3
<    8 NAVICL5
<    5 LBAND
<    8
<   16 GPSL1L2PL2CL5L1C
<    4 QZSSL1CAL2CL5L1CL6
<    4 SBASL1L5
<   14 GLOL1L2PL2CL3
<   11 GALE1E5AE5BALTB
<   16 BEIDOUB1B1CB2B3
<    8 NAVICL5
<    5 LBAND
```

2. There are five options given for the model and the first channel configuration set is currently being used.

3. If the user would like to use the third channel configuration set enter, **SELECTCHANCONFIG 3** command.
4. The receiver receives the command and resets. At startup, the third channel configuration set is configured.
5. To verify that setting has changed, enter LOG CHANCONFIGLIST.

```

<CHANCONFIGLIST COM1 0 74.5 FINESTEERING 2073 154125.980 02400020
d1c0 15823
< 3 5
< 7
< 16 GPSL1L2PL5
< 4 QZSSL1CAL2CL5
< 4 SBASL1
< 14 GLOL1L2
< 16 GALE1E5B
< 22 BEIDOUB1B2
< 5 LBAND
< 7
< 16 GPSL1L2
< 4 QZSSL1CAL2C
< 4 SBASL1
< 14 GLOL1L2
< 16 GALE1E5B
< 22 BEIDOUB1B2
< 5 LBAND
< 7
< 16 GPSL1L2PL2CL5
< 4 QZSSL1CAL2CL5
< 4 SBASL1
< 14 GLOL1L2PL2C
< 16 GALE1E5AE5BALTB0C
< 22 BEIDOUB1B2
< 5 LBAND
< 8
< 16 GPSL1L2PL2CL5
< 4 QZSSL1CAL2CL5
< 4 SBASL1L5
< 14 GLOL1L2PL2C
< 16 GALE1E5AE5BALTB0C
< 20 BEIDOUB1B1CB2B3
< 8 NAVICL5
< 5 LBAND
< 8
< 16 GPSL1L2PL2CL5L1C
< 4 QZSSL1CAL2CL5L1CL6
< 4 SBASL1L5
< 14 GLOL1L2PL2CL3
< 11 GALE1E5AE5BALTB0CE6
< 16 BEIDOUB1B1CB2B3
< 8 NAVICL5
< 5 LBAND

```

6. This log shows that the third set is selected. To further verify, enter **LOG TRACKSTAT** to show all the configured channels.

2.116 SEND

Sends an ASCII message to a COM port

Platform: OEM719, OEM729, OEM7500, OEM7600, OEM7700, OEM7720, PwrPak7, SPAN CPT7, SMART7, SMART2

This command is used to send ASCII printable data from any of the COM or USB ports to a specified communications port. This is a one time command, therefore the data message must be preceded by the **SEND** command and followed by <CR> each time data is sent. If the data string contains delimiters (that is, spaces, commas, tabs and so on), the entire string must be contained within double quotation marks. Carriage return and line feed characters (for example, 0x0D, 0x0A) are appended to the sent ASCII data.

Message ID: 177

Abbreviated ASCII Syntax:

```
SEND [port] data
```

ASCII Example

```
SEND com1 "log com1 rtcaobs ontime 5"
```



Scenario: Assume you are operating receivers as base and rover stations. It could also be assumed that the base station is unattended but operational and you wish to control it from the rover station. From the rover station, you could establish the data link and command the base station receiver to send differential corrections.

Figure 4: Using the SEND Command

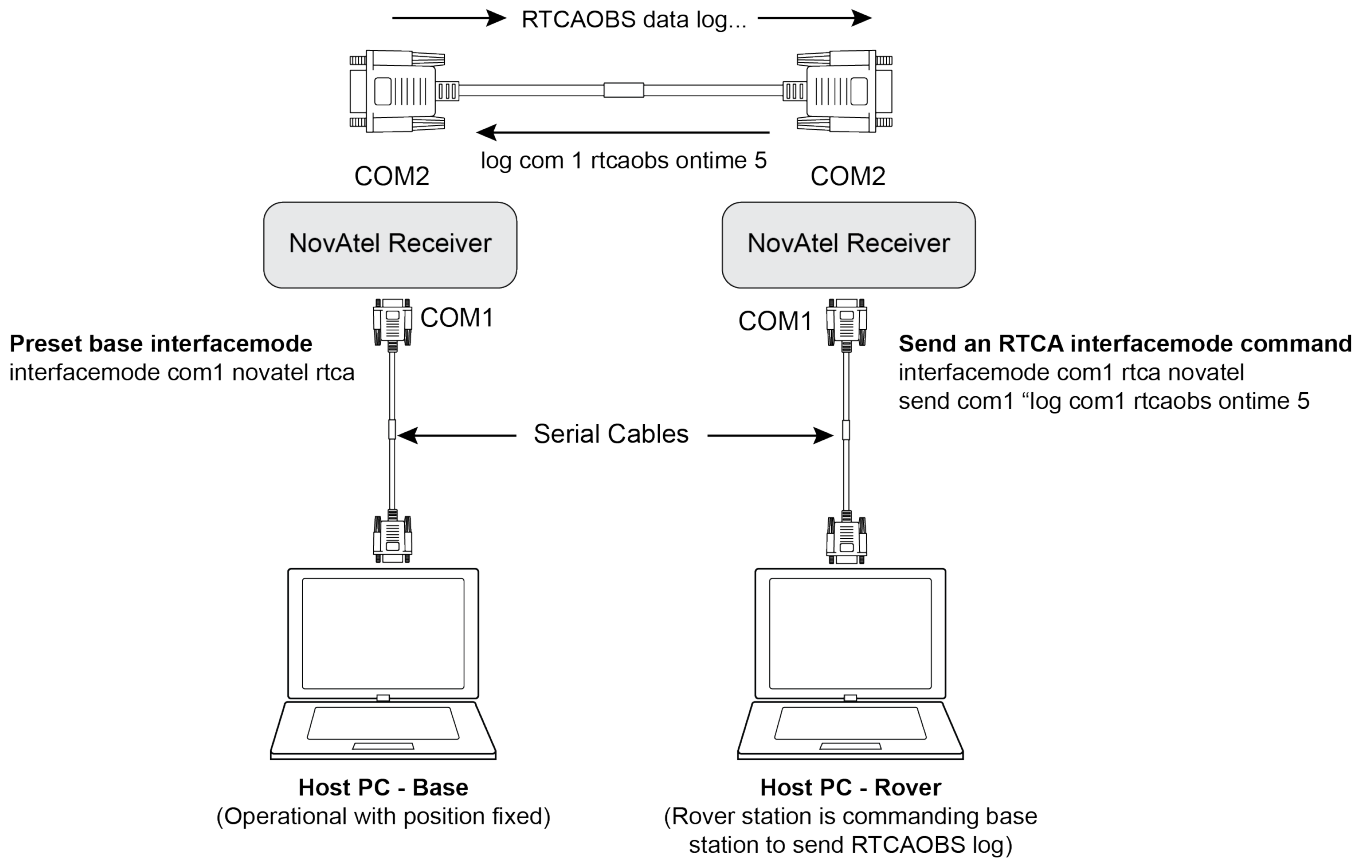

Field	Field Type	ASCII Value	Binary Value	Description	Format	Binary Bytes	Binary Offset
1	SEND header	-	-	Command header. See <i>Messages</i> on page 27 for more information.	-	H	0
2	port	See <i>Table 4: Detailed Port Identifier</i> on page 33		Output port (default=THISPORT)	Enum	4	H
3	message	Max 100 character string (99 typed visible chars and a null char added by the firmware automatically)		ASCII data to send	String [max 100]	Variable ¹	H+4

¹In the binary case, each string field needs to be NULL terminated and additional bytes of padding added to maintain 4-byte alignment, up to the maximum defined by the string size. The next defined field starts immediately at the next 4-byte alignment following the NULL.

2.117 SERIALCONFIG

Configures serial port settings

Platform: OEM719, OEM729, OEM7500, OEM7600, OEM7700, OEM7720, PwrPak7, SPAN CPT7, SMART7, SMART2

This command is used to configure the receiver's asynchronous serial port communications drivers.



1. Also refer to the **ECHO** command on page 109.
2. The **SERIALCONFIG** command can be used as a log to confirm settings.
3. The entire content of the current log is sent before pausing due to the receipt of the XOFF character.

The current SERIALCONFIG port configuration can be reset to its default state by sending it two hardware break signals of 250 milliseconds each, spaced by fifteen hundred milliseconds (1.5 seconds) with a pause of at least 250 milliseconds following the second break. This will:

- Stop the logging of data on the current port (see the **UNLOGALL** command on page 324)
- Clear the transmit and receive buffers on the current port
- Return the current port to its default settings (see *Command Defaults* on page 53 for details)
- Set the interface mode to NovAtel for both input and output (see the **INTERFACEMODE** command on page 148)

This break detection can be disabled using the **SERIALCONFIG** command.



1. The **COMCONTROL** command (see page 95) may conflict with handshaking of the selected COM port. If handshaking is enabled, then unexpected results may occur.
2. Baud rates higher than 115,200 bps are not supported by standard PC hardware. Special PC hardware may be required for higher rates, including 230400 bps and 460800 bps. Avoid having COM ports of two receivers connected together using baud rates that do not match. Data transmitted through a port operating at a slower baud rate may be misinterpreted as break signals by the receiving port if it is operating at a higher baud rate because data transmitted at the lower baud rate is stretched relative to the higher baud rate. In this case, configure the receiving port to break detection disabled using the **SERIALCONFIG** command.



Use the **SERIALCONFIG** command before using the **INTERFACEMODE** command on each port. Turn break detection off using the **SERIALCONFIG** command to stop the port from resetting because it is interpreting incoming bits as a break command.

Message ID: 1246

Abbreviated ASCII Syntax:

```
SERIALCONFIG [port] baud [parity[databits[stopbits[handshaking[break]]]]]
```

Factory Defaults:

```
SERIALCONFIG COM1 9600 N 8 1 N ON
SERIALCONFIG COM2 9600 N 8 1 N ON
SERIALCONFIG COM3 9600 N 8 1 N ON
SERIALCONFIG COM4 9600 N 8 1 N ON
SERIALCONFIG COM5 9600 N 8 1 N ON
```

ASCII Example:

```
SERIALCONFIG com1 9600 n 8 1 n off
```

Field	Field Type	ASCII Value	Binary Value	Description	Format	Binary Bytes	Binary Offset
1	SERIALCONFIG Header	-	-	Command header. See <i>Messages</i> on page 27 for more information.	-	H	0
2	port	See <i>Table 51: COM Port Identifiers</i> on the next page		Port to configure (default = THISPORT)	Enum	4	H
3	bps/baud	2400, 4800, 9600, 19200, 38400, 57600, 115200, 230400 and 460800		Communication baud rate (bps).	Ulong	4	H+4
4	parity	See <i>Table 52: Parity</i> on the next page		Parity	Enum	4	H+8
5	databits	7 or 8		Number of data bits (default = 8)	Ulong	4	H+12
6	stopbits	1 or 2		Number of stop bits (default = 1)	Ulong	4	H+16
7	handshake ¹	See <i>Table 53: Handshaking</i> on the next page		Handshaking	Enum	4	H+20
8	break	OFF	0	Disable break detection	Enum	4	H+24
		ON	1	Enable break detection (default)			

¹The OEM719, SPAN CPT7 and SMART7 do not support hardware handshaking. Only transmit and receive lines exist for the OEM719, SPAN CPT7 and SMART7 ports.

Table 51: COM Port Identifiers

Binary	ASCII	Description	Applicable Receiver
1	COM1	COM port 1	OEM719, OEM729, OEM7600, OEM7700, OEM7720, PwrPak7, SPAN CPT7, SMART7
2	COM2	COM port 2	OEM719, OEM729, OEM7600, OEM7700, OEM7720, PwrPak7, SPAN CPT7, SMART7
3	COM3	COM port 3	OEM729, OEM7600, OEM7700, OEM7720, PwrPak7, SMART7
6	THISPORT	The current COM port	OEM719, OEM729, OEM7600, OEM7700, OEM7720, PwrPak7, SPAN CPT7
19	COM4	COM port 4	OEM7700, OEM7600, OEM7720
21	IMU	IMU COM port	dependent on hardware configuration
31	COM5	COM port 5	OEM7700, OEM7600, OEM7720
32	COM6	COM port 6	
33	BT1	Bluetooth COM port	dependent on hardware configuration
34	COM7	COM port 7	
35	COM8	COM port 8	
36	COM9	COM port 9	
37	COM10	COM port 10	

Table 52: Parity

Binary	ASCII	Description
0	N	No parity (default)
1	E	Even parity
2	O	Odd parity

Table 53: Handshaking

Binary	ASCII	Description
0	N	No handshaking (default)
1	XON	XON/XOFF software handshaking
2	CTS	CTS/RTS hardware handshaking

2.118 SERIALPROTOCOL

Sets the protocol to be used by a serial port

Platform: OEM729, PwrPak7

On some OEM7 receiver cards, selected ports can support either RS-232 or RS-422 signaling protocol. The default protocol is RS-232. The **SERIALPROTOCOL** command is used to select the protocol (RS-232 or RS-422) supported on the port.



RS-422/RS-232 selection is available only on COM1 of the OEM729 or COM1 and COM2 on the PwrPak7.

Message ID: 1444

Abbreviated ASCII Syntax:

```
SERIALPROTOCOL port protocol
```

ASCII Example:

```
SERIALPROTOCOL COM1 RS422
```

Field	Field Type	ASCII Value	Binary Value	Description	Format	Binary Bytes	Binary Offset
1	SERIAL PROTOCOL header	-	-	Command header. See <i>Messages</i> on page 27 for more information.	-	H	0
2	port	See Table 54: <i>Ports Supporting RS-422</i> on the next page		Select the COM port on which the protocol is being set. The port that can be entered depends on the hardware platform being used.	Enum	4	H
3	protocol	RS232	0	Set the port to use RS-232 protocol	Enum	4	H+4
		RS422	1	Set the port to use RS-422 protocol			



After switching a COM port from RS-232 to RS-422, send a carriage return (CR) on the newly configured port to flush the buffer prior to sending new commands on the port.

Table 54: Ports Supporting RS-422

OEM7 Receiver Type	Allowable Ports	Binary Value
OEM719	None	
OEM729	COM1	1
OEM7600	None	
OEM7700	None	
OEM7720	None	
PwrPak7	COM1	1
	COM2	2

2.119 SETADMINPASSWORD

Sets the administration password

Platform: OEM729, OEM7600, OEM7700, OEM7720, PwrPak7, SPAN CPT7, SMART7-I, SMART7-SI

This command sets the administration password used to log into various web services.

- The administration password is required for Secure ICOM access.

The default admin password is the receiver's PSN. For OEM7 enclosures, such as the PwrPak7, the default password is the enclosure PSN. The enclosure PSN is shown on the label on the bottom of the enclosure and in the ENCLOSURE line in the **VERSION** log (see page 796). The default password should be changed before connecting the receiver to a network.

Message ID: 1579

Abbreviated ASCII Syntax:

```
SETADMINPASSWORD oldpassword newpassword
```

Input example

```
SETADMINPASSWORD ABC123 XYZ789
```

Field	Field Type	ASCII Value	Binary Value	Description	Format	Binary Bytes	Binary Offset
1	SETADMIN PASSWORD header	-	-	Command header. See <i>Messages</i> on page 27 for more information.	-	H	0
2	OldPassword	Maximum 28 character string		Previous password.	String [28]	variable ¹	H
3	NewPassword	Maximum 28 character string		New password.	String [28]	variable ¹	variable



This password can be restored to default (the receiver's PSN) by issuing the **FRESET USER_ACCOUNTS** command (see *FRESET* on page 127).

¹In the binary case, each string field needs to be NULL terminated and additional bytes of padding added to maintain 4-byte alignment, up to the maximum defined by the string size. The next defined field starts immediately at the next 4-byte alignment following the NULL.

2.120 SETAPPROXPOS

Sets an approximate position

Platform: OEM719, OEM729, OEM7500, OEM7600, OEM7700, OEM7720, PwrPak7, SPAN CPT7, SMART7, SMART2

This command sets an approximate latitude, longitude and height in the receiver. Estimating these parameters, when used in conjunction with an approximate time (see the **SETAPPROXTIME** command on the next page), can improve satellite acquisition times and Time To First Fix (TTFF). For more information about TTFF and Satellite Acquisition, refer to [An Introduction to GNSS](#) available on our website.

The horizontal position entered should be within 200 km of the actual receiver position. The approximate height is not critical and can normally be entered as zero. By default, if the receiver cannot calculate a valid position within 2.5 minutes of entering an approximate position, the approximate position is ignored.

The approximate position is not visible in any position logs. It can be seen by issuing a SETAPPROXPOS log.

Message ID: 377

Abbreviated ASCII Syntax:

```
SETAPPROXPOS lat lon height
```

Input Example:

```
SETAPPROXPOS 51.116 -114.038 0
```



For an example on the use of this command, refer to the **SETAPPROXTIME** command on the next page.

Field	Field Type	ASCII Value	Binary Value	Description	Format	Binary Bytes	Binary Offset
1	SETAPPROXPOS header	-	-	Command header. See <i>Messages</i> on page 27 for more information.	-	H	0
2	Lat	± 90 degrees		Approximate latitude	Double	8	H
3	Lon	± 180 degrees		Approximate longitude	Double	8	H+8
4	Height	-1000 to +20000000 m		Approximate height	Double	8	H+16

2.121 SETAPPROXTIME

Sets an approximate GPS reference time

Platform: OEM719, OEM729, OEM7500, OEM7600, OEM7700, OEM7720, PwrPak7, SPAN CPT7, SMART7, SMART2

This command sets an approximate time in the receiver. The receiver uses this time as system time until a coarse time can be acquired. This can be used in conjunction with an approximate position (see the **SETAPPROXPOS** command on the previous page) to improve Time To First Fix (TTFF). For more information TTFF and Satellite Acquisition, refer to [An Introduction to GNSS](#) available on our website.



The time entered should be within 10 minutes of the actual GPS reference time. If the week number entered does not match the broadcast week number, the receiver resets once it is tracking.

Message ID: 102

Abbreviated ASCII Syntax:

```
SETAPPROXTIME week sec
```

Input Example:

```
SETAPPROXTIME 1930 501232
```



Upon power up, the receiver does not know its position or time and therefore cannot use almanac information to aid satellite acquisition. You can set an approximate GPS reference time using the **SETAPPROXPOS** command (see page 282).

Approximate time and position may be used in conjunction with a current almanac to aid satellite acquisition. See the table below for a summary of the OEM7 family commands used to inject an approximated time or position into the receiver:

Approximate	Command
Time	SETAPPROXTIME
Position	SETAPPROXPOS

Base station aiding can help in these environments. A set of ephemerides can be injected into a rover station by broadcasting the RTCAEPHEM message from a base station. This is also useful in environments where there is frequent loss of lock. GPS ephemeris is three frames long within a sequence of five frames. Each frame requires 6 s of continuous lock to collect the ephemeris data. This gives a minimum of 18 s and a maximum of 36 s continuous lock time or when no recent ephemerides (new or stored) are available.

Field	Field Type	ASCII Value	Binary Value	Description	Format	Binary Bytes	Binary Offset
1	SETAPPROXTIME header	-	-	Command header. See <i>Messages</i> on page 27 for more information.	-	H	0
2	week	0-9999		GPS reference week number	Ulong	4	H
3	sec	0-604800		Number of seconds into GPS reference week	Double	8	H+4

2.122 SETBESTPOSCRITERIA

Sets selection criteria for BESTPOS

Platform: OEM719, OEM729, OEM7500, OEM7600, OEM7700, OEM7720, PwrPak7, SPAN CPT7, SMART7, SMART2

Use this command to set the criteria for the **BESTPOS** log (see page 371) and choose between 2D and 3D standard deviation to obtain the best position from the **BESTPOS** log (see page 371). It also allows you to specify the number of seconds to wait before changing the position type. This delay provides a single transition that ensures position types do not skip back and forth.



The **SETBESTPOSCRITERIA** command is also used as the basis for the **UALCONTROL** command (see page 312) standard deviations.

Message ID: 839

Abbreviated ASCII Syntax:

```
SETBESTPOSCRITERIA type [delay]
```

Factory Default:

```
SETBESTPOSCRITERIA pos3d 0
```

Input Example:

```
SETBESTPOSCRITERIA pos2d 5
```

Field	Field Type	ASCII Value	Binary Value	Description	Format	Binary Bytes	Binary Offset
1	SETBESTPOS CRITERIA header	-	-	Command header. See <i>Messages</i> on page 27 for more information.	-	H	0
2	type	See <i>Table 55: Selection Type</i> below		Select a 2D or 3D standard deviation type to obtain the best position from the BESTPOS log	Enum	4	H
3	delay	0 to 100 s		Set the number of seconds to wait before changing the position type. Default=0	Ulong	4	H+4

Table 55: Selection Type

ASCII	Binary	Description
POS3D	0	3D standard deviation
POS2D	1	2D standard deviation

2.123 SETIONOTYPE

Enables ionospheric models

Platform: OEM719, OEM729, OEM7500, OEM7600, OEM7700, OEM7720, PwrPak7, SPAN CPT7, SMART7, SMART2

Use this command to set which ionospheric corrections model the receiver should use. If the selected model is not available, the receiver reverts to AUTO.



L1 only models automatically use SBAS ionospheric grid corrections, if available.

Message ID: 711

Abbreviated ASCII Syntax:

```
SETIONOTYPE model
```

Factory Default:

```
SETIONOTYPE auto
```

ASCII Example:

```
SETIONOTYPE Klobuchar
```



An ionotype of AUTO is recommended for PDP and GLIDE.

Field	Field Type	ASCII Value	Binary Value	Description	Format	Binary Bytes	Binary Offset
1	SETIONOTYPE header	-	-	Command header. See <i>Messages</i> on page 27 for more information.	-	H	0
2	model	See Table 56: <i>Ionospheric Correction Models</i> below		Choose an ionospheric corrections model	Enum	4	H

Table 56: Ionospheric Correction Models

ASCII	Binary	Description
NONE	0	Don't use ionosphere modeling
KLOBUCHAR	1	Use the Klobuchar model broadcast by GPS
GRID	2	Use the SBAS grid model
L1L2	3	Use the L1/L2 model
AUTO	4	Automatically determine the ionospheric model to use

2.124 SETROVERID

Set ID for ALIGN rovers

Platform: OEM719, OEM729, OEM7500, OEM7600, OEM7700, OEM7720, PwrPak7, SPAN CPT7, SMART7

This command sets the Rover ID output in the **ROVERPOS** log (see page 661), **HEADING2** log (see page 469), **ALIGNBSLNXYZ** log (see page 350) and **ALIGNBSLNENU** log (see page 348).

The default value for the ID is set using the last six characters of the receiver PSN Number. For example, if the receiver PSN number is DAB07170027, ID is set as R027, i.e., 17 is represented as R and last three characters are filled in as is. The fourth last character is ignored.



It is not guaranteed that each receiver will have a unique auto-generated ID. Use this command to set the ID in case the auto-generated ID overlaps with other rovers. It is the user's responsibility to ensure each receiver ID is unique (if they own multiple receivers). If the ID overlaps, use this command to set the ID.

Message ID: 1135

Abbreviated ASCII Syntax:

```
SETROVERID rovid
```

Factory Default:

If the receiver PSN is: DAB07170027

```
SETROVERID R027
```

Input Example

```
SETROVERID rov1
```

Field	Field Type	ASCII Value	Binary Value	Description	Format	Binary Bytes	Binary Offset
1	SETROVERID header	-	-	Command header. See <i>Messages</i> on page 27 for more information.	-	H	0
2	ID	4 Character String e.g., ROV1		ID String (maximum 4 characters plus NULL)	String [5]	5 ¹	H

¹In the binary case, each string field needs to be NULL terminated and additional bytes of padding added to maintain 4-byte alignment, up to the maximum defined by the string size. The next defined field starts immediately at the next 4-byte alignment following the NULL.

2.125 SETUTCLEAPSECONDS

Sets future leap seconds

Platform: OEM719, OEM729, OEM7500, OEM7600, OEM7700, OEM7720, PwrPak7, SPAN CPT7, SMART7, SMART2

This command allows the user to force the UTC offset to be updated according to the input date.

Leap seconds will occur at the end of the UTC day specified. The receiver will use the leap second set by this command until a leap second can be obtained over the air.

Message ID: 1150

Abbreviated ASCII Syntax:

```
SETUTCLEAPSECONDS seconds [futureweeknumber [futuredaynumber
[futureseconds]]]
```

Input Example:

```
SETUTCLEAPSECONDS 18 1929 7 18
```

Field	Field Type	ASCII Value	Binary Value	Description	Format	Binary Bytes	Binary Offset
1	SETUTCLEAP SECONDS header	-	-	Command header. See <i>Messages</i> on page 27 for more information.	-	H	0
2	Seconds ¹	0-		Current UTC leap second	Ulong	4	H
3	Futureweek number	0-10000		GPS Week when future leap seconds will take effect	Ulong	4	H+4
4	Futureday number	1-7		Day of the week when future leap seconds will take effect	Ulong	4	H+8
5	Futureseconds	0-		Future leap second offset that will take effect at the end of the futuredaynumber of the futureweeknumber	Ulong	4	H+12

¹This value will only be applied if the UTC status in the TIME log is not Valid.

2.126 SOFTLOADCOMMIT

Completes the SoftLoad process

Platform: OEM719, OEM729, OEM7500, OEM7600, OEM7700, OEM7720, PwrPak7, SPAN CPT7, SMART7, SMART2

This command completes the SoftLoad process by verifying the downloaded image and activating it. Refer to Updating Using SoftLoad Commands in the [SMART7 Installation and Operation User Manual](#) for more information about the SoftLoad process.

This command can only be sent to the receiver when the **SOFTLOADSTATUS** log (see page 770) reports READY_FOR_DATA.

After issuing the **SOFTLOADCOMMIT** command the user must wait for the OK or ERROR command response before proceeding. This response is guaranteed to be output from the receiver within 300 seconds from the time the command was received by the receiver. If an error response is returned, consult the **SOFTLOADSTATUS** log on page 770 for more detail.

Message ID: 475

Abbreviated ASCII Syntax:

```
SOFTLOADCOMMIT
```

Input Example:

```
SOFTLOADCOMMIT
```

Field	Field Type	ASCII Value	Binary Value	Description	Format	Binary Bytes	Binary Offset
1	SOFTLOADCOMMIT header	-	-	Command header. See <i>Messages</i> on page 27 for more information.	-	H	0
2	Reserved	-		Reserved. Set to 1 in the binary case	Enum	4	H

2.127 SOFTLOADDATA

Sends firmware image data to the receiver for the SoftLoad process

Platform: OEM719, OEM729, OEM7500, OEM7600, OEM7700, OEM7720, PwrPak7, SPAN CPT7, SMART7, SMART2

This command is only valid in binary mode.

This command is used to upload data to the receiver for the SoftLoad process. Refer to Updating Using SoftLoad Commands in the [SMART7 Installation and Operation User Manual](#) for more information about the SoftLoad process.

After each **SOFTLOADDATA** command, the user must wait for the OK or ERROR command response before proceeding. This response is guaranteed to be output from the receiver within 15 seconds from the time the command was received by the receiver. If an error response is returned, consult the **SOFTLOADSTATUS** log on page 770 for more detail.

This command can only be sent to the receiver after the **SOFTLOADSREC** command (see page 294) or **SOFTLOADSETUP** command (see page 292) have sent the content of the S0 records from the start of a firmware *.shex file. In these cases, the **SOFTLOADSTATUS** log (see page 770) reports READY_FOR_SETUP or READY_FOR_DATA.

Message ID: 1218

Abbreviated ASCII Syntax:

Not applicable

Field	Field Type	Binary Value	Description	Format	Binary Bytes	Binary Offset
1	SOFTLOADDATA header	-	NovAtel binary message header	-	H	0
2	offset	-	Offset of the data within the downloaded image	Ulong	4	H
3	data length	-	Number of bytes of data. This must match the number of bytes contained within the "data" field	Ulong	4	H+4
4	data	-	Incoming data up to a maximum of 4096 bytes	Uchar	4096	H+8

2.128 SOFTLOADRESET

Initiates a new SoftLoad process

Platform: OEM719, OEM729, OEM7500, OEM7600, OEM7700, OEM7720, PwrPak7, SPAN CPT7, SMART7, SMART2

This command restarts the SoftLoad process. Refer to Updating Using SoftLoad Commands in the [SMART7 Installation and Operation User Manual](#) for more information about the SoftLoad process.

The command does not affect the flash and does not reset the receiver.

The **SOFTLOADRESET** command can be issued at any time. If it is issued while a SoftLoad process is currently in progress then that process is terminated and a new one is started. After the **SOFTLOADRESET** command is processed the SOFTLOADSTATUS log will report a status of READY_FOR_SETUP.

After issuing the **SOFTLOADRESET** command the user must wait for the OK or ERROR command response before proceeding. This response is guaranteed to be output from the receiver within 300 seconds from the time the command was received by the receiver. If an error response is returned, consult the **SOFTLOADSTATUS** log on page 770 for more detail.

Message ID: 476

Abbreviated ASCII Syntax:

```
SOFTLOADRESET
```

Input Example:

```
SOFTLOADRESET
```

Field	Field Type	ASCII Value	Binary Value	Description	Format	Binary Bytes	Binary Offset
1	SOFTLOADRESET header	-	-	Command header. See <i>Messages</i> on page 27 for more information.	-	H	0
2	Reserved	-	-	Reserved. Set to 1 in the binary case	Enum	4	H

2.129 SOFTLOADSETUP

Sends configuration information to the receiver for the SoftLoad process

Platform: OEM719, OEM729, OEM7500, OEM7600, OEM7700, OEM7720, PwrPak7, SPAN CPT7, SMART7, SMART2

The **SOFTLOADSETUP** command can be used in place of the **SOFTLOADSREC** command when sending S0 Records. This command is meant to be used if the user requires that the entire SoftLoad process be performed in binary, but can also be used in ASCII or abbreviated ASCII. The examples below are given in abbreviated ASCII for simplicity.

Refer to Updating Using SoftLoad Commands in the [SMART7 Installation and Operation User Manual](#) for more information about the SoftLoad process.

This command can only be sent to the receiver when the SOFTLOADSTATUS log reports READY_FOR_SETUP.

After each **SOFTLOADSETUP** command, the user must wait for the OK or ERROR command response before proceeding. This response is guaranteed to be output from the receiver within 15 seconds from the time the command was received by the receiver. If an error response is returned, consult the **SOFTLOADSTATUS** log on page 770 for more detail.

NovAtel S0 records use the following format: **S0~X~<<DATA>>**, where **X** is the Setup Type and **<<DATA>>** is a NULL terminated string. To convert from S0 record to the SOFTLOADSETUP command, convert the Setup Type to the appropriate Setup type enumeration, as described in *Table 57: Available Set Up Commands* on the next page, and copy the <<DATA>> string in to the Setup data string.

Message ID: 1219

Abbreviated ASCII Syntax:

```
SOFTLOADSETUP setuptype setupdata
```

Input Example:

```
SOFTLOADSETUP datatype "APP"
```

Field	Field Type	ASCII Value	Binary Value	Description	Format	Binary Bytes	Binary Offset
1	SOFTLOAD SETUP header	-	-	Command header. See <i>Messages</i> on page 27 for more information.	-	H	0
2	Setup type	See <i>Table 57: Available Set Up Commands</i> on the next page		The type of setup command	Enum	4	H

Field	Field Type	ASCII Value	Binary Value	Description	Format	Binary Bytes	Binary Offset
3	Setup data	-	-	ASCII setup data string. See <i>Table 57: Available Set Up Commands</i> below for details on this data. This data can be pulled from the S0 records of the hex file being loaded onto the receiver. If the ASCII form of this command is used, this string must be enclosed in double quotes (" ")	String [512]	variable ¹	H+4

Table 57: Available Set Up Commands

Binary	ASCII	Description
1	Platform	Comma separated list of platforms supported by the data to be uploaded. This corresponds to S0~P~. For example, the S-Record S0~P~OEM729,OEM7700,OEM719, translates to SOFTLOADSETUP PLATFORM "OEM729,OEM7700,OEM719"
2	Version	Version of the data to be uploaded. This corresponds to S0~V~. For example, the S-Record S0~V~OMP070400RN0000, translates to SOFTLOADSETUP VERSION "OMP070400RN0000"
3	Datatype	Intended data block for the data to be uploaded. This corresponds to S0~T~. For example, the S-Record S0~T~APP, translates to SOFTLOADSETUP DATATYPE "APP"
4	Authcode	PSN and AUTH code for the data to be uploaded. The format is: PSN:AuthCode. Note that since there are commas within the AuthCode, double quotes must surround the PSN:AuthCode string. For example: SOFTLOADSETUP AUTHCODE "BFN10260115:T48JF2,W25DBM,JH46BJ,2WGHMJ,8JW5TW,G2SR0RCCR,101114"

¹In the binary case, each string field needs to be NULL terminated and additional bytes of padding added to maintain 4-byte alignment, up to the maximum defined by the string size. The next defined field starts immediately at the next 4-byte alignment following the NULL.

2.130 SOFTLOADSREC

Sends an S-Record to the receiver for the SoftLoad process

Platform: OEM719, OEM729, OEM7500, OEM7600, OEM7700, OEM7720, PwrPak7, SPAN CPT7, SMART7, SMART2

Use this command to send S-Records to the receiver for the SoftLoad process. Refer to Updating Using SoftLoad Commands in the [SMART7 Installation and Operation User Manual](#) for more information about the SoftLoad process.

After each **SOFTLOADDATA** command, the user must wait for the OK or ERROR command response before proceeding. This response is guaranteed to be output from the receiver within 15 seconds from the time the command was received by the receiver. If an error response is returned, consult the **SOFTLOADSTATUS** log on page 770 for more detail.

This command can only be sent to the receiver when the SOFTLOADSTATUS log reports READY_FOR_SETUP or READY_FOR_DATA.

Message ID: 477

Abbreviated ASCII Syntax:

```
SOFTLOADSREC s-record
```

Input Example:

```
SOFTLOADSREC "S30900283C10FAA9F000EF"
```

Field	Field Type	ASCII Value	Binary Value	Description	Format	Binary Bytes	Binary Offset
1	SOFTLOADSREC header	-	-	Command header. See <i>Messages</i> on page 27 for more information.	-	H	0
2	SREC	-		ASCII S-Record string copied from firmware *.shex file	String [515]	variable 1	H
3	Reserved	-	1	Reserved. Set to 1 in the binary case	Ulong	4	variable

¹In the binary case, each string field needs to be NULL terminated and additional bytes of padding added to maintain 4-byte alignment, up to the maximum defined by the string size. The next defined field starts immediately at the next 4-byte alignment following the NULL.

2.131 STEADYLINE

Configures position mode matching

Platform: OEM719, OEM729, OEM7500, OEM7600, OEM7700, OEM7720, PwrPak7, SPAN CPT7, SMART7

The STEADYLINE® functionality helps mitigate the discontinuities that often occur when a GNSS receiver changes positioning modes. The effect is especially evident when a receiver transitions from an RTK position mode solution to a lower accuracy “fall back” solution, such as DGPS, WAAS+GLIDE or even autonomous GLIDE. Smooth transitions are particularly important for agricultural steering applications where sudden jumps may be problematic.

The STEADYLINE internally monitors the position offsets between all the positioning modes present in the receiver. When the receiver experiences a position transition, the corresponding offset is applied to the output position to limit a potential real position jump. When the original accurate position type returns, the STEADYLINE algorithm will slowly transition back to the new accurate position at a default rate of 0.005 m/s. This creates a smoother pass-to-pass relative accuracy at the expense of a possible degradation of absolute accuracy.

For example, a receiver can be configured to do both RTK and GLIDE. If this receiver has a fixed RTK position and experiences a loss of correction data causing the loss of the RTK solution it will immediately apply the offset between the two position modes and uses the GLIDE position stability to maintain the previous trajectory. Over time the GLIDE (or non-RTK) position will experience some drift. Once the RTK position is achieved again the receiver will start using the RTK positions for position stability and will slowly transition back to the RTK positions at a default rate of 0.005 m/s.

Message ID: 1452

Abbreviated ASCII Syntax:

```
STEADYLINE mode [transition_time]
```

Factory Default:

```
STEADYLINE disable
```

ASCII Example:

```
STEADYLINE prefer_accuracy 100
```

Field	Field Type	ASCII Value	Binary Value	Description	Format	Binary Bytes	Binary Offset
1	STEADYLINE header	-	-	Command header. See <i>Messages</i> on page 27 for more information.	-	H	0
2	mode	See <i>Table 58: STEADYLINE Mode</i> on the next page		STEADYLINE mode	Enum	4	H

Field	Field Type	ASCII Value	Binary Value	Description	Format	Binary Bytes	Binary Offset
3	Transition time			Time over which solutions will transition in seconds. The minimum rate of change is 0.005 m/s regardless of this parameter.	Ulong	4	H+4

Table 58: STEADYLINE Mode

ASCII	Binary	Description
DISABLE	0	Disable STEADYLINE (default)
RESET	3	Reset the offsets, jump immediately to the current position and continue in the current mode.
PREFER_ACCURACY	4	Slowly transition to the new reference position when changing from less accurate reference positioning type to more accurate reference positioning type. Maintains the position offset calculated when changing from more accurate reference positioning type to a less accurate reference positioning type.

2.132 STEADYLINEDIFFERENTIALTIMEOUT

Sets how long the receiver will report RTK/PPP after corrections are lost

Platform: OEM719, OEM729, OEM7500, OEM7600, OEM7700, OEM7720, PwrPak7, SPAN CPT7, SMART7

Use this command to set how long STEADYLINE will report RTK or PPP solutions after a loss of corrections. If able, STEADYLINE will report an RTK or PPP solution until this timeout expires or until the RTK/PPP timeout expires, whichever is higher.

For example:

- If the **RTKTIMEOUT** is 60 seconds and the **STEADYLINEDIFFERENTIALTIMEOUT** is 300 seconds, STEADYLINE will report an RTK solution for 300 seconds.
- If the **RTKTIMEOUT** is 60 seconds and the **STEADYLINEDIFFERENTIALTIMEOUT** is 30 seconds, STEADYLINE will report an RTK solution for 60 seconds.

Message ID: 2002

Abbreviated ASCII Syntax:

```
STEADYLINEDIFFERENTIALTIMEOUT timeout
```

Factory Default:

```
STEADYLINEDIFFERENTIALTIMEOUT 60
```

ASCII Example:

```
STEADYLINEDIFFERENTIALTIMEOUT 300
```

Field	Field Type	ASCII Value	Binary Value	Description	Format	Binary Bytes	Binary Offset
1	STEADYLINE DIFFERENTIALTIMEOUT header	-	-	Command header. See <i>Messages</i> on page 27 for more information.	-	H	0
2	timeout	5 to 1200		Timeout period in seconds	Float	4	H

2.133 SURVEYPOSITION

Saves or deletes a surveyed position

Platform: OEM719, OEM729, OEM7500, OEM7600, OEM7700, OEM7720, PwrPak7, SPAN CPT7, SMART7

Use this command to add or delete a surveyed position saved in the receiver NVM.

The surveyed positions added or deleted with this command are used in conjunction with the **AUTOSURVEY** command on page 66.

Message ID: 1952

Abbreviated ASCII Syntax:

```
SURVEYPOSITION option id [latitude] [longitude] [height] [tolerance]
```

ASCII Examples:

```
SURVEYPOSITION save auto 51.116 -114.038 1065.0 10.0
```

```
SURVEYPOSITION delete cal2
```

Field	Field Type	ASCII Value	Binary Value	Description	Format	Binary Bytes	Binary Offset
1	SURVEY POSITION header	-	-	Command header. See <i>Messages</i> on page 27 for more information.	-	H	0
2	option	SAVE	1	Save the surveyed position in the receiver NVM	Enum	4	H
		DELETE	2	Delete the surveyed position from the receiver NVM			
3	id	4 character string		<p>ID for the saved position</p> <p>When saving a position, "AUTO" can be entered and the receiver will automatically generate a unique ID for the position. "AUTO" cannot be used when deleting a position.</p> <p>To determine the ID for a saved position, use the SAVEDSURVEYPOSITIONS log on page 718.</p> <p>Note: In the Binary case, the ID string must be null terminated and additional bytes of padding must be added to make the total length of the field 8 bytes.</p>	String [5]	8	H+4

Field	Field Type	ASCII Value	Binary Value	Description	Format	Binary Bytes	Binary Offset
4	latitude	-90 to 90		Latitude of the position in degrees (default=0.0) A "-" sign denotes south and a "+" sign denotes north	Double	8	H+12
5	longitude	-360 to 360		Longitude of the position in degrees (default=0) A "-" sign denotes west and a "+" sign denotes east	Double	8	H+20
6	height	-1000 to 20000000		Mean Sea Level height of the position in meters (default=0.0)	Double	8	H+28
7	tolerance	3 - 100		Position tolerance in meters (default=10.0) The maximum distance between the position calculated during an self-survey and the saved position. During the self-survey, if the distance between the calculated position and the previously surveyed position is less than this value, the previous position is used.	Double	8	H+36

2.134 TECTONICSCOMPENSATIONSOURCE

Chooses the model to use for tectonics compensation

Platform: OEM719, OEM729, OEM7500, OEM7600, OEM7700, OEM7720, PwrPak7, SPAN CPT7, SMART7, SMART2

Use this command to enable tectonics (plate motion) compensation.

Message ID: 2290

Abbreviated ASCII Syntax:

TECTONICSCOMPENSATIONSOURCE model

Factory Default:

TECTONICSCOMPENSATIONSOURCE plate_motion_model

ASCII Example:

TECTONICSCOMPENSATIONSOURCE none

Field	Field Type	ASCII Value	Binary Value	Description	Format	Binary Bytes	Binary Offset
1	TECTONICS COMPENSATION SOURCE header	-	-	Command header. See <i>Messages</i> on page 27 for more information.	-	H	0
2	model	NONE	0	Do not use a tectonics model.	Enum	4	H
		PLATE_ MOTION_ MODEL	1	Automatically determine the plate the receiver is on and use the plate motion model of that plate.			
3	reserved				Char [32]	variable	H+4

2.135 TERRASTARAUTOCHANCONFIG

Enable channel configurations granted by eligible TerraStar subscriptions

Platform: OEM719, OEM729, OEM7500, OEM7600, OEM7700, OEM7720, PwrPak7, SPAN CPT7, SMART7

This command allows the receiver to use a multi-constellation, multi-frequency channel configuration while a TerraStar-X, TerraStar-C PRO or RTK ASSIST PRO subscription is active. This allows the receiver to make the best use of the TerraStar subscription while computing PPP position solutions. Multi-constellation, multi-frequency channel configurations give better accuracy and faster convergence time compared to a dual-constellation, dual-frequency channel configuration.

To enable this feature, issue the **TERRASTARAUTOCHANCONFIG ENABLE** command, followed by a **SAVECONFIG** command (see page 262). If a TerraStar-X, TerraStar-C PRO or RTK ASSIST PRO subscription is active, as reflected in the **TERRASTARINFO** log (see page 778), the channel configuration (see **CHANCONFIGLIST** log on page 395) will be modified on the next reboot.

Message ID: 2284

Abbreviated ASCII Syntax:

```
TERRASTARAUTOCHANCONFIG switch
```

Factory Default:

```
TERRASTARAUTOCHANCONFIG ENABLE
```

ASCII Example:

```
TERRASTARAUTOCHANCONFIG ENABLE
```

Field	Field Type	ASCII Value	Binary Value	Description	Format	Binary Bytes	Binary Offset
1	TERRASTARAUTOCHANCONFIG header	-	-	Command header. See <i>Messages</i> on page 27 for more information.	-	H	0
2	switch	DISABLE	0	The receiver does not use the channel configuration granted by the TerraStar subscription.	Enum	4	H
		ENABLE	1	The receiver uses the channel configuration granted by the TerraStar subscription.			

2.136 THISANTENNAPCO

Sets the PCO model of this receiver

Platform: OEM719, OEM729, OEM7500, OEM7600, OEM7700, OEM7720, PwrPak7, SPAN CPT7

Use the **THISANTENNAPCO** command to set the Phase Center Offsets (PCO) for the given frequency of this receiver. The Offsets are defined as North, East and Up from the Antenna Reference Point to the Frequency Phase Center in mm.

Message ID: 1417

Abbreviated ASCII Syntax:

```
THISANTENNAPCO Frequency[NorthOffset][EastOffset][UpOffset]
```

ASCII Example:

```
THISANTENNAPCO GPSL1 0.61 1.99 65.64
```

Field	Field Type	ASCII Value	Binary Value	Description	Format	Binary Bytes	Binary Offset
1	THISANTENNAPCO header	-	-	Command header. See <i>Messages</i> on page 27 for more information.	-	H	0
2	Frequency	See Table 16: <i>Frequency Type</i> on page 70		The frequency for which the phase center offsets are valid.	Enum	4	H
3	North Offset			NGS standard Phase Center North Offset (millimeters). ¹	Double	8	H+4
4	East Offset			NGS standard Phase Center East Offset (millimeters). ¹	Double	8	H+12
5	Up Offset			NGS standard Phase Center Up Offset (millimeters). ¹	Double	8	H+20

¹Enter values as per the NGS standards and tables to define which direction is plus or minus.

2.137 THISANTENNAPCV

Sets the PCV model of this receiver

Platform: OEM719, OEM729, OEM7500, OEM7600, OEM7700, OEM7720, PwrPak7, SPAN CPT7

Use the **THISANTENNAPCV** command to set the Phase Center Variation (PVC) for the given frequency of this receiver. The Phase Center Variation entries follow the NGS standard and correspond to the phase elevation at 5 degree increments starting at 90 degrees and decreasing to 0.

Message ID: 1418

Abbreviated ASCII Syntax:

```
THISANTENNAPCV Frequency[PCVArray]
```

ASCII Example:

```
THISANTENNAPCV GPSL1 0.00 -0.020 -0.07 -0.15 -0.24 -0.34 -0.43 -0.51 -0.56 -
0.61 -0.65 -0.69 -0.69 -0.62 -0.44 -0.13 0.28 0.70 1.02
```

Field	Field Type	ASCII Value	Binary Value	Description	Format	Binary Bytes	Binary Offset
1	THISANTENNAPCV header	-	-	Command header. See <i>Messages</i> on page 27 for more information.	-	H	0
2	Frequency	See Table 16: <i>Frequency Type</i> on page 70		The frequency for which the phase center variations is valid.	Enum	4	H
3	PCV Array			NGS standard 19 Element array of Phase Center Variations for phase variation for 5 degree elevation increments starting at 90 degrees and decreasing to 0. The variances are entered in millimeters.	Double Array [19]	152	H+4

2.138 THISANTENNATYPE

Sets the antenna type of this receiver

Platform: OEM719, OEM729, OEM7500, OEM7600, OEM7700, OEM7720, PwrPak7, SPAN CPT7

Use the **THISANTENNATYPE** command to set the type of antenna being used with the receiver. The antenna type and radome type are the NGS names for the antenna.



When antenna type is set using this command, the receiver will look up and use the Phase Center Variations and Phase Center Offsets from an internal table.

Message ID: 1420

Abbreviated ASCII Syntax:

```
THISANTENNATYPE AntennaType [RadomeType]
```

ASCII Examples:

```
THISANTENNATYPE NOV702
```

```
THISANTENNATYPE USER_ANTENNA_1
```

Field	Field Type	ASCII Value	Binary Value	Description	Format	Binary Bytes	Binary Offset
1	THISANTENNATYPE header	-	-	Command header. See <i>Messages</i> on page 27 for more information.	-	H	0
2	AntennaType	See <i>Table 17: Antenna Type</i> on page 73		Antenna type	Enum	4	H
3	RadomeType	See <i>Table 18: Radome Type</i> on page 81		Radome type (default = NONE)	Enum	4	H+4

2.139 TILTCOMPENSATIONCONTROL

Control the application of position corrections for vehicle roll and pitch

Platform: SMART7, SMART7-I, SMART7-W, SMART2-TB

Use this command to enable or disable the application of position corrections computed by the Terrain Compensation filter to output positions. If disabled, the Terrain Compensation filter will continue to run in the background but the reported position will be the antenna position.



The **TILTFILTER** command on the next page and **TILTZERO** command on page 307, or the **\$PMDT** command on page 209, are used to configure the Terrain Compensation feature.

Message ID: 2309

Abbreviated ASCII Syntax:

TILTCOMPENSATIONCONTROL switch

Abbreviated ASCII Example:

TILTCOMPENSATIONCONTROL ENABLE

Field	Field Type	ASCII Value	Binary Value	Description	Format	Binary Bytes	Binary Offset
1	TILTCOMPENSATION CONTROL header	-	-	Command header. See <i>Messages</i> on page 27 for more information.	-	H	0
2	switch	DISABLE	0	Disable Terrain Compensation (Tilt) corrections.	Enum	4	H
		ENABLE	1	Enable Terrain Compensation (Tilt) corrections.			

2.140 TILTFILTER

Configure the Terrain Compensation filter

Platform: SMART7, SMART7-I, SMART7-W, SMART2-TB

Use this command to enable or disable estimation of the system pitch and roll by the Terrain Compensation filter and to set the height of the GNSS antenna above the vehicle control point. The Terrain Compensation filter must be enabled for the Terrain Compensation feature to function.



The **\$PMDT** command (see page 209) can also be used to enable and configure the Terrain Compensation filter.

Message ID: 1221

Abbreviated ASCII Syntax:

```
TILTFILTER switch antennaheight
```

Abbreviated ASCII Example:

```
TILTFILTER ENABLE 3.5
```

Field	Field Type	ASCII Value	Binary Value	Description	Format	Binary Bytes	Binary Offset
1	TILTFILTER header	-	-	Command header. See <i>Messages</i> on page 27 for more information.	-	H	0
2	switch	DISABLE	0	Disable the Tilt filter.	Enum	4	H
		ENABLE	1	Enable the Tilt filter.			
3	antennaheight	0.0 – 12.7		Height of the GNSS antenna above the vehicle control point (meters). (default = 0.0) Refer to Terrain Compensation in the SMART7 Installation and Operation User Manual for information about mounting the SMART antenna and measuring the antenna height.	Float	4	H+4
4	Reserved				Ulong	4	H+8
5	Reserved				Ulong	4	H+12

2.141 TILTZERO

Set the zero level and save Terrain Compensation settings to NVM

Platform: SMART7, SMART7-I, SMART7-W, SMART2-TB

Use this command to set the internal zero level for Terrain Compensation and to save the settings (including antenna height which is configured with the **TILTFILTER** command on the previous page) to NVM.

Sending this command with the **ZERO** option will set the current roll and pitch as the zero level. Setting the zero level allows the Terrain Compensation filter to account for any mounting offset between the receiver and the vehicle or any inherent tilt of the vehicle. It will also observe the internal sensor biases to allow for better performance of the filter. Zeroing must be conducted while the vehicle is stationary on a flat surface.

Sending this command with the **SAVE** option will save the zero level and antenna height settings to NVM. These settings will be automatically used on following startups.

Sending this command with the **RESTORE** option will clear the saved settings from NVM and restore the factory defaults.



The **\$PMDT** command (see page 209) can also be used to zero the filter and save the settings to NVM.

Message ID: 1222

Abbreviated ASCII Syntax:

```
TILTZERO action
```

ASCII Example:

```
TILTZERO zero
```

Field	Field Type	ASCII Value	Binary Value	Description	Format	Binary Bytes	Binary Offset
1	TILTZERO header	-	-	Command header. See <i>Messages</i> on page 27 for more information.	-	H	0
2	action	ZERO	0	Set the current orientation as zero (level).	Enum	4	H
		SAVE	1	Saves the current level setting and antenna height to NVM.			
		RESTORE	2	Clear the current Tilt filter settings saved in NVM and restore the factory defaults.			

2.142 TRACKSV

Overrides automatic satellite assignment criteria

Platform: OEM719, OEM729, OEM7500, OEM7600, OEM7700, OEM7720, PwrPak7, SPAN CPT7, SMART7, SMART2

This command is used to override the automatic satellite/channel assignment for all satellites with manual instructions.

Message ID: 1326

Abbreviated ASCII Syntax:

```
TRACKSV system SVID condition
```

Factory Default:

GPS, GLONASS, GALILEO, QZSS, BeiDou and NavIC default = GOODHEALTH

SBAS default = ANYHEALTH

TRACKSV QZSS 198 NEVER

TRACKSV QZSS 202 NEVER



QZSS 198 and QZSS 202 are excluded because they are defined as test PRNs in the QZSS ICD.

Input Example:

```
TRACKSV GALILEO 0 ANYHEALTH
```



For dual antenna receivers, this command applies to both the primary and secondary antennas.

Field	Field Type	ASCII Value	Binary Value	Description	Format	Binary Bytes	Binary Offset
1	TRACKSV header	-	-	Command header. See <i>Messages</i> on page 27 for more information.	-	H	0
2	System	See <i>Table 93: Satellite System</i> on page 477		System that the SVID belongs to	Enum	4	H
3	SVID	Refer to <i>PRN Numbers</i> on page 46		Satellite SVID number "0" is allowed and applies to all SVIDs for the specified system type	Ulong	4	H+4
4	Condition	See <i>Table 59: TRACKSV Command Condition</i> below		Tracking condition	Enum	4	H+8

Table 59: TRACKSV Command Condition

Binary	ASCII	Description
1	NEVER	Never track this satellite
2	GOODHEALTH	Track this satellite if the health is indicated as healthy in both the almanac and ephemeris
3	ANYHEALTH	Track this satellite regardless of health status
4	ALWAYS	Always track this satellite

2.143 TUNNELESCAPE

Breaks out of an established tunnel

Platform: OEM719, OEM729, OEM7500, OEM7600, OEM7700, OEM7720, PwrPak7, SPAN CPT7, SMART7, SMART2

The tunnel escape sequence feature allows you to break out of a tunnel between two ports by sending a predefined sequence of bytes through the tunnel in-line with the data stream.

Use the **TUNNELESCAPE** command to specify the tunnel escape sequence. The escape sequence is applied independently to all active tunnels. Use the **SAVECONFIG** command (see page 262) to save the escape sequence in case of a power cycle.

This command is used to define an escape sequence that, when detected in a byte stream between any two COM (or AUX) ports, resets the interface mode to **NOVATEL NOVATEL** on those ports. The baud rate and other port parameters remain unaffected.

The **TUNNELESCAPE** command accepts three parameters. The first is the *switch* parameter with **ENABLE** or **DISABLE** options. The second is the *length* parameter. It is a number from 1 to 8 and must be present if the switch parameter is set to **ENABLE**. The third parameter, *esc seq*, consists of a series of pairs of digits representing hexadecimal numbers, where the number of pairs are equal to the value entered for the second parameter. The series of hexadecimal pairs of digits represent the escape sequence. The receiver detects a sequence in a tunnel exactly as it was entered.

For example, the command **TUNNELESCAPE ENABLE 4 61626364** searches for the bytes representing "abcd" in a tunnel stream. **TUNNELESCAPE ENABLE 3 AA4412** searches for the NovAtel binary log sync bytes.

You must first set up a tunnel. For example, create a tunnel between COM1 and COM2 by entering **INTERFACEMODE COM1 TCOM2 NONE OFF**. The commands can be entered in any order.



1. All bytes, leading up to and including the escape sequence, pass through the tunnel before it is reset. Therefore, the escape sequence is the last sequence of bytes that passes through the tunnel. Configure the receiver to detect and interpret the escape sequence. For example, use this information to reset equipment or perform a shut-down process.
2. The receiver detects the escape sequence in all active tunnels in any direction.
3. Create tunnels using the **INTERFACEMODE** command (see page 148).

Message ID: 962

Abbreviated ASCII Syntax:

```
TUNNELESCAPE switch length escseq
```

Factory Default:

```
TUNNELESCAPE disable 0
```

ASCII Example:

```
TUNNELESCAPE enable 1 aa
```

Field	Field Type	ASCII Value	Binary Value	Description	Format	Binary Bytes	Binary Offset
1	TUNNELESCAPE header	-	-	Command header. See <i>Messages</i> on page 27 for more information.	H	0	-
2	switch	DISABLE	0	Enable or disable the tunnel escape mode	Enum	4	H
		ENABLE	1				
3	length	1 to 8		Specifies the number of hex bytes to follow	Ulong	4	H+4
4	escseq			Escape sequence where Hex pairs are entered without spaces, for example, AA4412	Uchar [8]	8	H+8



If using the **SAVECONFIG** command (see page 262) in NovAtel Connect, ensure all windows other than the *Console* window are closed. If open, NovAtel Connect also saves log commands used for its various windows. This results in unnecessary data being logged.

2.144 UALCONTROL

Setup User Accuracy levels

Platform: OEM719, OEM729, OEM7500, OEM7600, OEM7700, OEM7720, PwrPak7, SPAN CPT7, SMART7, SMART2

The **UALCONTROL** command is used to define User Accuracy Levels. User accuracy levels are user defined standard deviations thresholds, used to determine solution acceptability. Issuing the **UALCONTROL** command causes the BESTPOS and GPGGA solution types to be controlled via the specified thresholds, rather than by the solution source or mode. The new solution types are described in the table below.

Table 60: User Accuracy Level Supplemental Position Types and NMEA Equivalents

Value	BESTPOS Position Type ¹	NMEA Equivalent ²
70	OPERATIONAL	4
71	WARNING	5
72	OUT_OF_BOUNDS	1

1. As reported in the **BESTPOS** log (see page 371).
2. Refers to the GPGGA quality indicator (see the **GPGGA** log on page 444 for details).

The **SETBESTPOSCRITERIA** command (see page 285) determines which standard deviations are compared against the provided thresholds.



UAL is useful for applications that rely upon specific solutions types being present in the BESTPOS or GPGGA logs. For example, if an agricultural steering system commonly requires an RTK fixed GPGGA solution type (4) to operate, and interruptions in RTK conventionally cause the GPGGA to switch to another solution type. This causes the steering system to disengage.

Message ID: 1627

Abbreviated ASCII Syntax:

```
UALCONTROL Action [Operational_limit] [Warning_limit]
```

Factory Default:

```
UALCONTROL disable
```

ASCII Example:

```
UALCONTROL enable 0.10 0.20
```

Field	Field Type	ASCII Value	Binary Value	Description	Format	Binary Bytes	Binary Offset
1	UALCONTROL header	-	-	Command header. See <i>Messages</i> on page 27 for more information.	-	H	0
2	Action	DISABLE	0	Disables this feature	Enum	4	H
		ENABLE	1	Replace BESTPOS and GPFGA position types with OPERATIONAL, WARNING or OUT_OF_BOUNDS based on the entered standard deviations (refer to <i>Table 60: User Accuracy Level Supplemental Position Types and NMEA Equivalents</i> on the previous page)			
		CLEAR	2	Disable this feature and reset the entered standard deviations.			
3	Operational Limit			Standard deviation in meters to report OPERATIONAL	Double	8	H+4
4	Warning Limit			Standard deviation in meters to report WARNING Note: OUT_OF_BOUND reports when the standard deviation exceeds this value	Double	8	H+12

2.145 UNASSIGN

Unassigns a previously assigned channel

Platform: OEM719, OEM729, OEM7500, OEM7600, OEM7700, OEM7720, PwrPak7, SPAN CPT7, SMART7, SMART2

This command cancels a previously issued **ASSIGN** command (see page 56) and the SV channel reverts to automatic control (the same as **ASSIGN AUTO**).

Message ID: 29

Abbreviated ASCII Syntax:

```
UNASSIGN channel [state]
```

Input Example:

```
UNASSIGN 11
```



Issuing the **UNASSIGN** command to a channel that was not previously assigned by the **ASSIGN** command (see page 56) has no effect.



For dual antenna receivers:

- On the primary antenna, the SV channel is from 0 to N-1, where N is the number of channels in the primary antenna channel configuration.
- On the secondary antenna, the SV channel count is from at N to N+(M-1), where M is the number of channels in the secondary antenna SV channel configuration.
- Even though L-Band channels cannot be configured with **ASSIGN** or **UNASSIGN**, they are included when determining N.



The **ASSIGN** and **UNASSIGN** commands are not accepted for L-Band channels. The **ASSIGNLBANDBEAM** command (see page 61) should be used for L-Band channels.

Field	Field Type	ASCII Value	Binary Value	Description	Format	Binary Bytes	Binary Offset
1	UNASSIGN header	-	-	Command header. See <i>Messages</i> on page 27 for more information.	-	H	0

Field	Field Type	ASCII Value	Binary Value	Description	Format	Binary Bytes	Binary Offset
2	channel	0 to N-1, where N is the number of the last GNSS channel in the current channel configuration		Channel number reset to automatic search and acquisition mode	Ulong	4	H
3	state	These return SV channel control to the automatic search engine immediately (see <i>Table 12: Channel State</i> on page 58)		Set the SV channel state (currently ignored)	Enum	4	H+4

2.146 UNASSIGNALL

Unassigns all previously assigned channels

Platform: OEM719, OEM729, OEM7500, OEM7600, OEM7700, OEM7720, PwrPak7, SPAN CPT7, SMART7, SMART2

This command cancels all previously issued **ASSIGN** or **ASSIGNALL** commands for all SV channels for a satellite system (same as **ASSIGNALL AUTO**). Tracking and control for each SV channel reverts to automatic mode.

Message ID: 30

Abbreviated ASCII Syntax:

```
UNASSIGNALL [system]
```

Input Example:

```
UNASSIGNALL GPS
```



Issuing the **UNASSIGNALL** command has no effect on channels that were not previously assigned using the **ASSIGN** command (see page 56) or **ASSIGNALL** command (see page 59).

Field	Field Type	ASCII Value	Binary Value	Description	Format	Binary Bytes	Binary Offset
1	UNASSIGNALL header	-	-	Command header. See <i>Messages</i> on page 27 for more information.	-	H	0
2	system	See <i>Table 13: Satellite System</i> on page 60		System that will be affected by the UNASSIGNALL command (default = ALL)	Enum	4	H

2.147 UNDULATION

Chooses undulation

Platform: OEM719, OEM729, OEM7500, OEM7600, OEM7700, OEM7720, PwrPak7, SPAN CPT7, SMART7, SMART2

This command permits you to enter a specific geoidal undulation value. In the option field, the EGM96 table provides ellipsoid heights at a 0.5° by 0.5° spacing while the OSU89B is implemented at a 2° by 3° spacing. In areas of rapidly changing elevation, you could be operating somewhere within the 2° by 3° grid with an erroneous height. EGM96 provides a more accurate model of the ellipsoid which results in a denser grid of heights. It is also more accurate because the accuracy of the grid points themselves has also improved from OSU89B to EGM96. For example, the default grid (EGM96) is useful where there are underwater canyons, steep drop-offs or mountains.

The undulation values reported in the position logs are in reference to the ellipsoid of the chosen datum.

Refer to the application note [APN-006 Geoid Issue](#), available on our website www.novatel.com/support/search/ for a description of the relationships in *Figure 5: Illustration of Undulation* below.

Figure 5: Illustration of Undulation

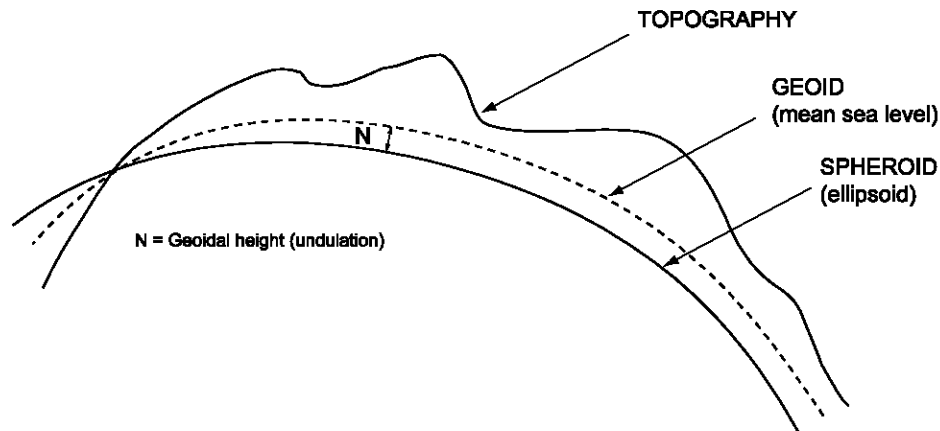

Message ID: 214

Abbreviated ASCII Syntax:

```
UNDULATION option [separation]
```

Factory Default:

```
UNDULATION egm96 0.0000
```

ASCII Example 1:

```
UNDULATION osu89b
```

ASCII Example 2:

```
UNDULATION USER -5.599999905
```

Field	Field Type	ASCII Value	Binary Value	Description	Format	Binary Bytes	Binary Offset
1	UNDULATION header	-	-	Command header. See <i>Messages</i> on page 27 for more information.	-	H	0
2	option	USER	1	Use the user specified undulation value	Enum	4	H
		OSU89B	2	Use the OSU89B undulation table			
		EGM96	3	Use global geoidal height model EGM96 table			
3	separation	±1000.0 m		The undulation value (required for the USER option) (default = 0.000)	Float	4	H+4

2.148 UNLOCKOUT

Reinstates a satellite in the solution

Platform: OEM719, OEM729, OEM7500, OEM7600, OEM7700, OEM7720, PwrPak7, SPAN CPT7, SMART7, SMART2

This command allows a satellite which has been previously locked out (**LOCKOUT** command on page 172) to be reinstated in the solution computation. If more than one satellite is to be reinstated, this command must be reissued for each satellite reinstatement.

Message ID: 138

Abbreviated ASCII Syntax:

```
UNLOCKOUT prn
```

Input Example:

```
UNLOCKOUT 8
```



The **UNLOCKOUT** command is used to reinstate a satellite while leaving other locked out satellites unchanged.

This command can be used for GPS, GLONASS, SBAS and QZSS.

Field	Field Type	ASCII Value	Binary Value	Description	Format	Binary Bytes	Binary Offset
1	UNLOCKOUT header	-	-	Command header. See <i>Messages</i> on page 27 for more information.	-	H	0
2	prn	Refer to <i>PRN Numbers</i> on page 46		A single satellite PRN number to be reinstated	Ulong	4	H

2.149 UNLOCKOUTALL

Reinstates all previously locked out satellites

Platform: OEM719, OEM729, OEM7500, OEM7600, OEM7700, OEM7720, PwrPak7, SPAN CPT7, SMART7, SMART2

This command allows all satellites or systems which have been previously locked out (**LOCKOUT** command on page 172 or **LOCKOUTSYSTEM** command on page 173) to be reinstated in the solution computation.

Message ID: 139

Abbreviated ASCII Syntax:

UNLOCKOUTALL

Input Example:

UNLOCKOUTALL

Field	Field Type	ASCII Value	Binary Value	Description	Format	Binary Bytes	Binary Offset
1	UNLOCKOUTALL header	-	-	Command header. See <i>Messages</i> on page 27 for more information.	-	H	0

2.150 UNLOCKOUTSYSTEM

Reinstates previously locked out system

Platform: OEM719, OEM729, OEM7500, OEM7600, OEM7700, OEM7720, PwrPak7, SPAN CPT7, SMART7, SMART2

This command allows a system which has been previously locked out (refer to the **LOCKOUTSYSTEM** command on page 173) to be reinstated in the solution computation.



If more than one system is to be reinstated, this command must be reissued for each system reinstatement.

Message ID: 908

Abbreviated ASCII Syntax:

UNLOCKOUTSYSTEM system

Input Example:

UNLOCKOUTSYSTEM glonass



The **UNLOCKOUTSYSTEM** command is used to reinstate a system while leaving other locked out systems unchanged.

Field	Field Type	ASCII Value	Binary Value	Description	Format	Binary Bytes	Binary Offset
1	UNLOCKOUT SYSTEM header	-	-	Command header. See <i>Messages</i> on page 27 for more information.	-	H	0
2	system	See <i>Table 93: Satellite System</i> on page 477		A single satellite system to be reinstated	Enum	4	H

2.151 UNLOG

Removes a log from logging control

Platform: OEM719, OEM729, OEM7500, OEM7600, OEM7700, OEM7720, PwrPak7, SPAN CPT7, SMART7, SMART2

This command is used to remove a specific log request from the system.

Message ID: 36

Abbreviated ASCII Syntax:

```
UNLOG [port] message
```

Input Example:

```
UNLOG com1 bestposa
```

```
UNLOG bestposa
```



The **UNLOG** command is used to remove one or more logs while leaving other logs unchanged.

2.151.1 Binary

Field	Field Name	Binary Value	Description	Format	Binary Bytes	Binary Offset
1	UNLOG (binary) header	(See Table 3: Binary Message Header Structure on page 31)	This field contains the message header	-	H	0
2	port	See Table 4: Detailed Port Identifier on page 33 (decimal port values greater than 16 may be used)	Port to which log is being sent	Enum	4	H
3	message	Any valid message ID	Message ID of log to output	Ushort	2	H+4

Field	Field Name	Binary Value	Description	Format	Binary Bytes	Binary Offset
4	message type	Bits 0-4 = Reserved Bits 5-6 = Format 00 = Binary 01 = ASCII 10 = Abbreviated ASCII, NMEA 11 = Reserved Bit 7 = Response Bit (<i>Message Responses</i> on page 42) 0 = Original Message 1 = Response Message	Message type of log	Char	1	H+6
5	Reserved			Char	1	H+7

2.151.2 ASCII

Field	Field Type	ASCII Value	Binary Value	Description	Format	Binary Bytes	Binary Offset
1	UNLOG (ASCII) header	-	-	This field contains the command name or the message header depending on whether the command is abbreviated ASCII or ASCII, respectively	-	H	0
2	port	See Table 4: <i>Detailed Port Identifier</i> on page 33 (decimal port values greater than 16 may be used)		Port to which log is being sent (default = THISPORT)	Enum	4	H
3	message	Message Name	N/A	Message Name of log to be disabled	Ulong	4	H+4

2.152 UNLOGALL

Removes all logs from logging control

Platform: OEM719, OEM729, OEM7500, OEM7600, OEM7700, OEM7720, PwrPak7, SPAN CPT7, SMART7, SMART2

If [*port*] is specified, this command disables all logs on the specified port only. All other ports are unaffected. If [*port*] is not specified this command defaults to the ALL_PORTS setting.

Message ID: 38

Abbreviated ASCII Syntax:

```
UNLOGALL [port] [held]
```

Input Example:

```
UNLOGALL com2_15
UNLOGALL true
```



The **UNLOGALL** command is used to remove all log requests currently in use.

Field	Field Type	ASCII Value	Binary Value	Description	Format	Binary Bytes	Binary Offset
1	UNLOGALL header	-	-	Command header. See <i>Messages</i> on page 27 for more information.	-	H	0
2	port	See Table 4: <i>Detailed Port Identifier</i> on page 33 (decimal values greater than 16 may be used)		Port to clear (default = ALL_PORTS)	Enum	4	H
3	held	FALSE	0	Does not remove logs with the HOLD parameter (default)	Bool	4	H+4
		TRUE	1	Removes previously held logs, even those with the HOLD parameter			

2.153 USERDATUM

Sets user customized ellipsoid and datum transformation

Platform: OEM719, OEM729, OEM7500, OEM7600, OEM7700, OEM7720, PwrPak7, SPAN CPT7, SMART7, SMART2

This command is like the **USEREXPDATUM** command but without parameter rates. See the **USEREXPDATUM** command on page 327 for details on command usage and parameter meaning.

When the **USERDATUM** command is entered, the **USEREXPDATUM** command on page 327 is issued internally with the **USERDATUM** command values. It is the **USEREXPDATUM** command on page 327 that appears in the **RXCONFIG** log (see page 684). Only a single set of **USEREXPDATUM** or **USERDATUM** entered parameters is valid at one time. Newer parameters entered by either command will overwrite previously entered parameters.



See the **DATUM** command on page 100 for important guidance and details on datum operation.

Message ID: 78

Abbreviated ASCII Syntax:

```
USERDATUM semi_major_axis flattening dx dy dz rx ry rz scale
```

Factory Default:

```
USERDATUM 6378137.0 298.2572235628 0.0 0.0 0.0 0.0 0.0 0.0 0.0
```

ASCII Example:

```
USERDATUM 6378206.400 294.97869820000 -12.0000 147.0000 192.0000 0.0000
0.0000 0.0000 0.0000000000
```

Field	Field Type	ASCII Value	Binary Value	Description	Format	Binary Bytes	Binary Offset
1	USERDATUM header	-	-	Command header. See <i>Messages</i> on page 27 for more information.	-	H	0
2	semi_major_axis	6300000.0 - 6400000.0		Datum semi-major axis (a) (meters)	Double	8	H
3	flattening	290.0 - 305.0		Reciprocal Flattening, $1/f = a/(a-b)$	Double	8	H+8
4	dx	± 2000.0		Translation values (meters)	Double	8	H+16
5	dy	± 2000.0			Double	8	H+24
6	dz	± 2000.0			Double	8	H+32

Field	Field Type	ASCII Value	Binary Value	Description	Format	Binary Bytes	Binary Offset
7	rx	± 10.0 radians		Datum rotation angles	Double	8	H+40
8	ry	± 10.0 radians		A positive sign is for counter clockwise rotation and a negative sign is for clockwise rotation	Double	8	H+48
9	rz	± 10.0 radians			Double	8	H+56
10	scale	± 10.0 ppm		Scale value is the difference in ppm	Double	8	H+64

2.154 USEREXPDATUM

Set custom expanded datum

Platform: OEM719, OEM729, OEM7500, OEM7600, OEM7700, OEM7720, PwrPak7, SPAN CPT7, SMART7, SMART2

This command permits entry of customized ellipsoid and datum transformation parameters. The command **DATUM USER** must be sent for the parameters set by **USERDATUM** to take effect.

Only a single set of **USEREXPDATUM** or **USERDATUM** entered parameters is valid at one time. Newer parameters entered by either command will overwrite previously entered parameters.

The transformation used by this command is the 7 parameter Helmert transformation, with the parameters provided being for the transformation from the user datum to WGS84:

$$\begin{bmatrix} X_s \\ Y_s \\ Z_s \end{bmatrix} = \begin{bmatrix} T_x \\ T_y \\ T_z \end{bmatrix} + (1 + s) \begin{bmatrix} 1 & -R_z & R_y \\ R_z & 1 & -R_x \\ -R_y & R_x & 1 \end{bmatrix} \begin{bmatrix} X \\ Y \\ Z \end{bmatrix}$$

Where:

X, Y, Z are the coordinates in the user datum

X_s, Y_s, Z_s are the coordinates in WGS84

T_x, T_y, T_z are the translation parameters corrected for translation rate (meters)

R_x, R_y, R_z are the rotation parameters corrected for rotation rate (radians)

s is the scale difference corrected for scale rate (unitless)

A given parameter P is corrected for rate:

$$P(t) = P(t_r) + \dot{P}(t_r) (t - t_r)$$

Where:

t_r is the reference epoch of the parameters

t is the current epoch

P(t_r) is the parameter at the reference epoch

Ḑ(t_r) is the rate of the parameter at the reference epoch

The convention used by this command differs from that used by the

DATUMTRANSFORMATION command on page 102, and from parameter conventions seen typically in transformation sources. Care should be taken that the parameter convention matches that in the equation above.



See the **DATUM** command on page 100 for important guidance and details on datum operation.

Message ID: 783

Abbreviated ASCII Syntax:

```
USEREXPDATUM semi_major_axis flattening dx dy dz rx ry rz scale xvel yvel
zvel xrvel yrvel zrvel scalelevel epoch
```

Factory Default:

```
USEREXPDATUM 6378137.0 298.25722356280 0.0 0.0 0.0 0.0 0.0 0.0 0.0 0.0 0.0 0.0
0.0 0.0 0.0 0.0 0.0 0.0
```

ASCII Example:

```
USEREXPDATUM 6378137.000 298.25722356280 0.000000000 0.000000000 0.000000000
0.000000000 0.000000000 0.000000000 0.000000000 0.000000000 0.000000000
0.000000000 0.0000 0.000000000 0.000000000 0.000000000 0.000000000
```



Use the **USEREXPDATUM** command in a survey to fix the position with values from another known datum so that the GPS calculated positions are reported in the known datum rather than WGS84. For example, it is useful for places like Australia, where the continent is moving several centimeters a year relative to WGS84. With **USEREXPDATUM**, you can also input the velocity of the movement to account for drift over the years.

Field	Field Type	ASCII Value	Binary Value	Description	Format	Binary Bytes	Binary Offset
1	USEREXPDATUM header	-	-	Command header. See <i>Messages</i> on page 27 for more information.	-	H	0
2	semi_major_axis	6300000.0 - 6400000.0 m		Datum semi-major axis (a) (meters)	Double	8	H
3	flattening	290.0 - 305.0		Reciprocal Flattening, $1/f = a/(a-b)$	Double	8	H+8
4	dx	± 2000.0 m	Translation values (meters)		Double	8	H+16
5	dy	± 2000.0 m			Double	8	H+24
6	dz	± 2000.0 m			Double	8	H+32
7	rx	± 10.0 radians	Datum rotation angles A positive sign is for counter clockwise rotation and a negative sign is for clockwise rotation		Double	8	H+40
8	ry	± 10.0 radians			Double	8	H+48
9	rz	± 10.0 radians			Double	8	H+56
10	scale	± 10.0 ppm		Scale value is the difference in ppm	Double	8	H+64
11	xvel	± 2000.0 m/yr		Velocity vector along X-axis	Double	8	H+72
12	yvel	± 2000.0 m/yr		Velocity vector along Y-axis	Double	8	H+80

Field	Field Type	ASCII Value	Binary Value	Description	Format	Binary Bytes	Binary Offset
13	zvel		± 2000.0 m/yr	Velocity vector along Z-axis	Double	8	H+88
14	xrvel		± 10.0 radians/yr	Change in the rotation about X over time	Double	8	H+96
15	yrvel		± 10.0 radians/yr	Change in the rotation about Y over time	Double	8	H+104
16	zrvel		± 10.0 radians/yr	Change in the rotation about Z over time	Double	8	H+112
17	scalelevel		± 10.0 ppm/yr	Change in scale from WGS84 over time	Double	8	H+120
18	epoch		0.0 year	Reference epoch of parameters (decimal year) Example: 2011.00 = Jan 1, 2011 2011.19 = Mar 11, 2011	Double	8	H+128

2.155 USERI2CREAD

Read data from devices on the I2C bus

Platform: OEM7600, OEM7700, OEM7720

Use this command to read data from devices on the I2C bus.



This command only applies to OEM7 receivers that have I2C signals available on the interface connector. The compatible receivers are listed in the **Platform** section above.

The **USERI2CRESPONSE** log (see page 791) can be used to check the completion or status of the read operation. An optional user defined Transaction ID can be provided to help synchronize requests with responses in the **USERI2CRESPONSE** log (see page 791). This command is primarily intended to be used by Lua applications that need to interact with external devices.

Reading from an I2C device requires a device address, to distinguish which physical device is to be accessed, a register within the device, and the expected number of bytes to be read. Depending on the type of I2C device, register addresses can be 1 to 4 bytes in length, so the actual number of bytes for the register address must be specified.

For some I2C devices there are no registers within the device. In this case, the Register Address Length is 0 and no bytes are supplied for the Register Address.

The **USERI2CREAD** command is flexible to handle all of these situations.

Message ID: 2232

Abbreviated ASCII Syntax:

```
USERI2CREAD DeviceAddress RegisterAddressLen RegisterAddress RequestReadLen
[TransactionID]
```

Examples:

```
USERI2CREAD 70 1 AB 12 1234
USERI2CREAD 74 3 ABCDEF 234 5678
USERI2CREAD 74 0 234 5678
```

Field	Field Type	Description	Format	Binary Bytes	Binary Offset
1	USERI2CREAD header	Command header. See Messages for more information.	-	H	0

Field	Field Type	Description	Format	Binary Bytes	Binary Offset
2	DeviceAddress	The 7 bit address of the I2C device. Valid values are 0 through 127. For ASCII and Abbreviated commands, this field is a hexadecimal string of two digits. There is no 0x prefix and spaces are not allowed in the string.	Uchar	1 ¹	H
3	RegisterAddressLen	The length of the register address that follows. Valid values are 0 through 4.	Ulong	4	H+4
4	RegisterAddress	The actual address of the register to be read. The number of bytes here must match the RegisterAddressLen. In particular, when RegisterAddressLen is 0, this field is empty (even for a binary command) For ASCII and Abbreviated commands, this field is a hexadecimal string of two digits for each byte in the register address. There is no 0x prefix and spaces are not allowed in the string.	Uchar Array	X ¹	H+8
5	RequestReadLen	The length of data expected to be retrieved from the device. Valid values are 1 through 256.	Ulong	4	H+12 ²
6	TransactionID	An optional user provided ID for this transaction. Default = 0. This transaction ID will be copied to the USERI2CRESPONSE log (see page 791) created for this read operation.	Ulong	4	H+16 ³

¹In the binary case, additional bytes of padding are added after this field to maintain 4-byte alignment for the fields that follow.

²H+8 if X=0

³H+12 if X=0

2.156 USERI2CWRITE

Write data to device on I2C bus

Platform: OEM7600, OEM7700, OEM7720

Use this command to write data to devices on the I2C bus.



This command only applies to OEM7 receivers that have I2C signals available on the interface connector. The compatible receivers are listed in the **Platform** section above.

The **USERI2CRESPONSE** log (see page 791) can be used to check the completion or status of the write operation. An optional user defined Transaction ID can be provided to help synchronize requests with responses in the **USERI2CRESPONSE** log (see page 791). This command is primarily intended to be used by Lua applications that need to interact with external devices.

Writing to an I2C device requires a device address, to distinguish which physical device is to be accessed, a register within the device and the data. Depending on the type of I2C device, register addresses can be 1 to 4 bytes in length, and so the actual number of bytes for the register address must be specified.

For some I2C devices there are no registers within the device. In this case, the Register Address Length is 0, and no bytes are supplied for the Register Address.

For some other I2C devices, write operations are done in two stages:

1. The first stage sends a write command with a register address, but no data. This is a dummy write to set the register within the device for write operations that follow.
2. The second stage sends a write command with no register address, but does send a stream of data.

The **USERI2CWRITE** command is flexible to handle all of these situations.

Message ID: 2233

Abbreviated ASCII Syntax:

```
USERI2CWRITE DeviceAddress RegisterAddressLen RegisterAddress
WriteDataLength WriteData [TransactionID]
```

Examples:

```
USERI2CWRITE 70 1 AB 12 3132333435363738393A3B3C 1234
```

```
USERI2CWRITE 74 3 ABCDED 5 1234567890 1234
```

```
USERI2CWRITE 40 0 5 1234567890 1234
```

```
USERI2CWRITE 40 2 AABB 0 1234 (a dummy write)
```

Field	Field Type	Description	Format	Binary Bytes	Binary Offset
1	USERI2CWRITE header	Command header. See Messages for more information.	-	H	0

Field	Field Type	Description	Format	Binary Bytes	Binary Offset
2	DeviceAddress	The 7 bit address of the I2C device. Valid values 0 through 127. For ASCII and Abbreviated commands, this field is a hexadecimal string of two digits. There is no 0x prefix and spaces are not allowed in the string.	Uchar	1 ¹	H
3	RegisterAddressLen	The length of the register address that follows. Valid values are 0 through 4.	Ulong	4	H+4
4	RegisterAddress	The actual address of the register to be written. The number of bytes here must match the RegisterAddressLen. In particular, when RegisterAddressLen is 0, this field is empty (even for a binary command) For ASCII and Abbreviated commands, this field is a hexadecimal string of two digits for each byte in the register address. There is no 0x prefix and spaces are not allowed in the string.	Uchar Array	X ¹	H+8
5	WriteDataLength	The length of data to be written in bytes. Valid values are 0 through 256.	Ulong	4	H+12 ²

¹In the binary case, additional bytes of padding are added after this field to maintain 4-byte alignment for the fields that follow.

²H+8 if X=0

Field	Field Type	Description	Format	Binary Bytes	Binary Offset
6	WriteData	<p>The data to be written. The number of bytes in this data block must match the WriteDataLength. In particular, when WriteDataLength is 0, this field is empty.</p> <p>For ASCII and Abbreviated commands, this field is a hexadecimal string of two digits for each byte in the data block. There is no 0x prefix and spaces are not allowed in the string.</p> <p>Data is streamed to the device as a series of bytes in the order provided.</p>	Uchar Array	Y ¹	H+16 ²
7	TransactionID	<p>An optional user provided ID for this transaction. Default = 0.</p> <p>This transaction ID will be copied to the USERI2CRESPONSE log (see page 791) created for this write operation.</p>	Ulong	4	H+16+4*INT((Y+3)/4) ³

¹In the binary case, additional bytes of padding are added after this field to maintain 4-byte alignment for the fields that follow.

²H+12 if X=0

³H+12+4*INT((Y+3)/4) if X=0

2.157 WIFIALIGNAUTOMATION

Configure the ALIGN plug-and-play feature over Wi-Fi

Platform: PwrPak7, SMART7-I, SMART7-SI, SMART7-W

Use this command to simplify the configuration of a pair of receivers; one acting as an ALIGN Master and the other acting as an ALIGN Rover.

Similar to the **ALIGNAUTOMATION** command (see page 54) the ALIGN Rover, acting as a Wi-Fi Client, connects to the specified Wi-Fi Access Point and configures it as an ALIGN Master.



The IP address of the ALIGN Rover and ALIGN Master must be different. Since all NovAtel receivers are delivered with the same default IP address, it is highly recommended to use the **WIFIPIPCONFIG** command (see page 338) to change the IP address of the ALIGN Rover to a non-default value such as 192.168.20.1 prior to entering the **WIFIALIGNAUTOMATION** command. Failure to do so may result in loss of wireless communication to the ALIGN Rover.

Message ID: 2214

Abbreviated ASCII Syntax:

```
WIFIALIGNAUTOMATION option [master_networkid] [corrections_port] [datarate]
[headingextboption] [interfacemode]
```

Factory Default:

```
WIFIALIGNAUTOMATION DISABLE
```

Example:

```
WIFIALIGNAUTOMATION enable 1 icom1 10 on novatelx
```

Field	Field Type	ASCII Value	Binary Value	Description	Format	Binary Bytes	Binary Offset
1	WIFIALIGN AUTOMATION header	-	-	Command header. See <i>Messages</i> on page 27 for more information.	-	H	0
2	option	ENABLE	1	Enable or disable the plug-and-play feature.	Enum	4	H
		DISABLE	0				
3	master_network	1-4		Network id of Align Master Access Point as defined in the WIFINETCONFIG command (see page 343).	Ulong	4	H+4

Field	Field Type	ASCII Value	Binary Value	Description	Format	Binary Bytes	Binary Offset
4	corrections_port	ICOM1	23	Name of ICOM port to be used by Rover and Master. Caution: The Master ICOM port must be configured with factory default settings. (default=ICOM1)	Enum	4	H+8
		ICOM2	24				
		ICOM3	25				
		ICOM4	29				
		ICOM5	46				
		ICOM6	47				
		ICOM7	48				
5	datarate	1, 2, 4, 5, 10 or 20		Rate (in Hz) at which heading output is required (default = ICOM1)	Ulong	4	H+12
6	headingextboption	OFF	0	Enable or disable sending HEADINGEXTB / HEADINGEXT2B back to Master (default=ON)	Enum	4	H+16
		ON	1				
7	interfacemode	see See Table 30: Serial Port Interface Modes on the next page on page 150		Interfacemode for corrections (default = NONE) If this parameter is not specified, the ALIGN Master is not configured to generate any corrections. The assumption is that the master has been separately configured. Refer to ALIGN Over Wi-Fi Overview in the SMART7 Installation and Operation User Manual for details on ALIGN.	Enum	4	H+20

2.158 WIFIAPCHANNEL

Set the channel for the Wi-Fi access point

Platform: PwrPak7, SMART7-I, SMART7-SI, SMART7-W

Use this command to set the operating channel for the Wi-Fi module when operating as an access point. The new channel will be used the next time the **WIFIMODE AP** or **WIFIMODE CONCURRENT** command is received.

Message ID: 2091

Abbreviated ASCII Syntax:

```
WIFIAPCHANNEL channel
```

Factory Default:

```
WIFIAPCHANNEL 11
```

Example:

```
WIFIAPCHANNEL 6
```

Field	Field Type	ASCII Value	Binary Value	Description	Format	Binary Value	Binary Offset
1	WIFIAPCHANNEL header	-	-	Command header. See <i>Messages</i> on page 27 for more information.	-	H	0
2	channel	1-14		802.11 channel	Long	4	H



For best performance, choose one of the non-overlapping channels: 1, 6, or 11.

2.159 WIFIPIPCONFIG

Set the IP address and netmask for the Wi-Fi access point

Platform: PwrPak7, SMART7-I, SMART7-SI, SMART7-W

Use this command to set the Wi-Fi IP address and netmask for Wi-Fi module when operating as an access point. The new network configuration takes effect the next time the **WIFIMODE AP** or **WIFIMODE CONCURRENT** command is received.

Message ID: 2096

Abbreviated ASCII Syntax:

```
WIFIPIPCONFIG ip_address ip_netmask
```

Factory Default:

```
WIFIPIPCONFIG 192.168.19.1 255.255.255.0
```

Example:

```
WIFIPIPCONFIG 192.162.55.20 255.255.0.0
```

Field	Field Type	ASCII Value	Binary Value	Description	Format	Binary Bytes	Binary Offset
1	WIFIPIPCONFIG header	-	-	Command header. See <i>Messages</i> on page 27 for more information.	-	H	0
2	ip_address	Null-terminated ASCII string		IP address, dot decimal format	String [16]	Variable	H
3	ip_netmask	Null-terminated ASCII string		IP netmask, dot decimal format (optional) Default =255.255.255.0	String [16]	Variable	Variable

2.160 WIFIAPPASSKEY

Set Wi-Fi access point passkey

Platform: PwrPak7, SMART7-I, SMART7-SI, SMART7-W

Use this command to set the WPA2 PSK ASCII passkey for the Wi-Fi module when the receiver is operating as an Access Point.

The default passkey is printed on the receiver label.

The new passkey takes effect the next time the **WIFIMODE AP** or **WIFIMODE CONCURRENT** command is received.



The term passkey and password are the same.

Message ID: 2090

Abbreviated ASCII Syntax:

```
WIFIAPPASSKEY passkey
```

Factory Default:

The default passkey/password is printed on the receiver label.

Example:

```
WIFIAPPASSKEY "bysP3zE6SZmFQeyd"
```

Field	Field Type	ASCII Value	Binary Value	Description	Format	Binary Bytes	Binary Offset
1	WIFIAPPASSKEY header	-	-	Command header. See <i>Messages</i> on page 27 for more information.	-	H	0
2	passkey	Null-terminated ASCII string, 8 to 64 characters		WPA2 PSK ASCII passkey	String [65]	Variable	H

2.161 WIFIAPSSID

Set the SSID for the Wi-Fi access point

Platform: PwrPak7, SMART7-I, SMART7-SI, SMART7-W

Use this command to explicitly set the SSID of the Access Point when the receiver is configured to operate in either AP or CONCURRENT mode (refer to the **WIFIMODE** command on the next page for details regarding the Wi-Fi configuration modes).

Message ID: 2206

Abbreviated ASCII Syntax:

```
WIFIAPSSID ssid
```

Factory Default:

```
<platform-dependent prefix>-<Enclosure PSN>
```

Example:

```
PwrPak7-NMND17190003B
```

```
SM7i-NMPX17500010L
```

Example:

```
WIFIAPSSID SomeSSIDName
```

```
WIFIAPSSID "SSID with spaces"
```

Field	Field Type	ASCII Value	Binary Value	Description	Format	Binary Bytes	Binary Offset
1	WIFIAPSSID header	-	-	Command header. See <i>Messages</i> on page 27 for more information.	-	H	0
2	SSID	Null-terminated ASCII string		SSID to be broadcast by access point	String [33]	Variable	H

2.162 WIFIMODE

Configure the receiver Wi-Fi mode

Platform: PwrPak7, SMART7-I, SMART7-SI, SMART7-W

Use this command to enable, disable or set the operating mode of Wi-Fi on the receiver. This command is also applies any Wi-Fi configuration changes specified by other Wi-Fi commands such as **WIFIAPCHANNEL**.

Message ID: 2144

Abbreviated ASCII Syntax:

```
WIFIMODE mode
```

Factory Default:

```
WIFIMODE AP
```

Example:

```
WIFIMODE CLIENT
```

```
WIFIMODE OFF
```

Field	Field Type	ASCII Value	Binary Value	Description	Format	Binary Bytes	Binary Offset
1	WIFIMODE header	-	-	Command header. See <i>Messages</i> on page 27 for more information.	-	H	0

Field	Field Type	ASCII Value	Binary Value	Description	Format	Binary Bytes	Binary Offset
2	mode	OFF	0	Power off the Wi-Fi module	Enum	4	H
		AP	1	Configure the Wi-Fi module as an Access Point (AP)			
		CLIENT	2	Configure the Wi-Fi module as a Client/Station			
		ON	3	Supply power to the Wi-Fi module, but do not configure it.			
		CONCURRENT	4	Configure the Wi-Fi module as both an access point and Client/Station simultaneously. When configured in this mode it is possible to connect the receiver to an access point and for Clients/Stations to connect to the receiver simultaneously.			

2.163 WIFINETCONFIG

Set the connection parameters of Wi-Fi to which the Wi-Fi client can connect

Platform: PwrPak7, SMART7-I, SMART7-SI, SMART7-W

Use this command to specify Access Points (AP) to which the Client/Station will automatically connect when the receiver's Wi-Fi Client/Station functionality is enabled (refer to the **WIFIMODE** command (see page 341) for details regarding the Wi-Fi configuration modes).



If the Wi-Fi Client/Station is already connected to an access point (defined using this command), the connection remains in effect even when a more preferred access point comes into range (preferred as indicated by `network_id`).



If Wi-Fi ALIGN automation is enabled, the Client only connects to the Access Point specified in the **WIFIALIGNAUTOMATION** command (see page 335).



The term passkey and password are the same.

Message ID: 2213

Abbreviated ASCII Syntax:

```
WIFINETCONFIG network_id switch [ssid [passkey [address_mode [IP_address
]netmask [gateway [dns]]]]]]]]
```

Factory Default:

```
WIFINETCONFIG 1 DISABLE
```

```
WIFINETCONFIG 2 DISABLE
```

```
WIFINETCONFIG 3 DISABLE
```

```
WIFINETCONFIG 4 DISABLE
```

Example:

```
WIFINETCONFIG 1 ENABLE SomeSSID 12345678
```

```
WIFINETCONFIG 2 ENABLE AnotherSSID 1A2b3C4d STATIC 192.168.19.1
```

Field	Field Type	ASCII Value	Binary Value	Description	Format	Binary Bytes	Binary Offset
1	WIFINETCONFIG header	-	-	Command header. See <i>Messages</i> on page 27 for more information.	-	H	0

Field	Field Type	ASCII Value	Binary Value	Description	Format	Binary Bytes	Binary Offset
2	network_id	1, 2, 3, 4		The Network identifier value is used to prioritize network connections when more than one network is in range of the client. The access point with the lowest network_id is chosen.	Ulong	4	H
3	switch	DISABLE	0	When set to Disable, the client will not connect to an access point with this SSID.	Enum	4	H+4
		ENABLE	1	When set to Enable, the client connects to an access point with this SSID if there are no other APs with a lower network_id in range.			
4	ssid	Null-terminated ASCII string		Access Points with non-ASCII SSIDs are not supported. Required if switch is set to ENABLE.	String [33]	Variable	
5	passkey	Null-terminated ASCII string, 8 to 64 characters		Passkey required to connect to access point identified by "ssid" parameter. (default = "")	String [65]	Variable	
6	address_mode	DHCP	1	Use dynamic IP address (default = DHCP)	Enum	4	
		STATIC	2	Use static IP address			

Field	Field Type	ASCII Value	Binary Value	Description	Format	Binary Bytes	Binary Offset
7	ip_address	ddd.ddd.ddd.ddd		IP Address - decimal dot notation The IP address is mandatory when the address mode is STATIC.	String [16]	Variable	
8	netmask	ddd.ddd.ddd.ddd		Netmask – decimal dot notation (default = 255.255.255.0)	String [16]	Variable	
9	gateway	ddd.ddd.ddd.ddd		Gateway – decimal dot notation (default = 0.0.0.0)	String [16]	Variable	
10	dns	ddd.ddd.ddd.ddd		DNS server – decimal dot notation (default = 0.0.0.0)	String [16]	Variable	

Chapter 3 Logs

3.1 Log Types

See the **LOG** command on page 174, for details about requesting logs.

The receiver is capable of generating three type of logs: synchronous, asynchronous and polled. The data for synchronous logs is generated on a regular schedule. In order to output the most current data as soon as it is available, asynchronous data is generated at irregular intervals. The data in polled logs is generated on demand. The following table outlines the log types and the valid triggers to use:

Table 61: Log Type Triggers

Type	Recommended Trigger	Illegal Trigger
Synch	ONTIME	ONNEW, ONCHANGED
Asynch	ONCHANGED or ONCE	-
Polled	ONCE or ONTIME ¹	ONNEW, ONCHANGED

See *Message Time Stamps* on page 47 for information about how the message time stamp is set for each type of log.



1. The OEM7 family of receivers can handle 80 logs at a time. If an attempt is made to log more than 80 logs at a time, the receiver responds with an Insufficient Resources error.
2. Asynchronous logs, such as MATCHEDPOS, should only be logged ONCHANGED. Otherwise, the most current data is not output when it is available. This is especially true of the ONTIME trigger, which may result in inaccurate time tags.
3. Use the ONNEW trigger with the MARKxTIME or MARKxPOS logs.
4. Before the output of fields for logs, there is a header. See *ASCII* on page 29, *Abbreviated ASCII* on page 30 and *Binary* on page 31.

3.1.1 Log Type Examples

For polled logs, the receiver only supports an offset that is:

- smaller than the logging period
- decimal values that are a multiple of the maximum logging rate defined by the receiver model. For more information see the **LOG** command on page 174.

The following are valid examples for a polled log:

```
log portstats ontime 4 2
```

```
log version once
```

For polled logs, the following examples are invalid:

¹Polled log types do not allow fractional offsets and cannot do ontime rates faster than 1 Hz.

```
log serialconfig ontime 1 2      [offset is larger than the logging period]
```

```
log serialconfig ontime 4 1.5    [offset is not an integer]
```

For synchronous and asynchronous logs, the receiver supports any offset that is both:

- smaller than the logging period
- a multiple of the minimum logging period

For example, if the receiver supports 20 Hz logging, the minimum logging period is 1/20 Hz or 0.05 s. The following are valid examples for a synchronous or asynchronous log, on a receiver that can log at rates up to 20 Hz:

```
log bestpos ontime 1             [1 Hz]
```

```
log bestpos ontime 1 0.1
```

```
log bestpos ontime 1 0.90
```

```
log avepos ontime 1 0.95
```

```
log avepos ontime 2             [0.5 Hz]
```

```
log avepos ontime 2 1.35
```

```
log avepos ontime 2 1.75
```

For synchronous and asynchronous logs, the following examples are invalid:

```
log bestpos ontime 1 0.08      [offset is not a multiple of the minimum logging period]
```

```
log bestpos ontime 1 1.05      [offset is larger than the logging period]
```

3.2 ALIGNBSLNENU

ENU baselines using ALIGN

Platform: OEM719, OEM729, OEM7500, OEM7600, OEM7700, OEM7720, PwrPak7, SPAN CPT7, SMART7

This log outputs the RTK quality ENU baselines from ALIGN. The XYZ baselines (output in the **ALIGNBSLNXYZ** log on page 350) are rotated relative to master position (output in MASTERPOS) to compute ENU baselines.



On dual antenna receivers, the baseline vector from the primary to the secondary antenna is provided. Additionally, with an ALIGN Relative Positioning model, the baseline vector from an external base station to the primary antenna is also available. The baseline vector from an external base station to the secondary antenna is not available.

Message ID: 1315

Log Type: Asynch

Recommended Input:

```
log alignbslnenua onnew
```

ASCII Example:

```
#ALIGNBSLNENU,COM1,0,29.0,FINESTEERING,1629,259250.000,02040000,100b,39448;
SOL_COMPUTED,NARROW_INT,4.1586,-1.9197,-0.0037,0.0047,0.0050,0.0062,"0092",
"AAAA",22,16,16,16,0,01,0,33*11e1d4c0
```

Field	Field type	Description	Format	Binary Bytes	Binary Offset
1	ALIGNBSLNENU	Log header. See <i>Messages</i> on page 27 for more information.		H	0
2	sol stat	Solution status, see <i>Table 65: Solution Status</i> on page 374	Enum	4	H
3	pos type	Position type, see <i>Table 66: Position or Velocity Type</i> on page 375	Enum	4	H+4
4	East	East Baseline (relative to master position) in meters	Double	8	H+8
5	North	North Baseline (relative to master position) in meters	Double	8	H+16
6	Up	Up Baseline (relative to master position) in meters	Double	8	H+24
7	East σ	East Baseline standard deviation in meters	Float	4	H+32

Field	Field type	Description	Format	Binary Bytes	Binary Offset
8	North σ	North Baseline standard deviation in meters	Float	4	H+36
9	Up σ	Up Baseline standard deviation in meters	Float	4	H+40
10	Rover id	Rover Receiver ID Set using the SETROVERID command (see page 287) on the Rover e.g., setroverid RRRR	Char[4]	4	H+44
11	Master id	Master Receiver ID Set using the DGPSTXID command (see page 105) on the Master Default: AAAA	Char[4]	4	H+48
12	#SVs	Number of satellites tracked	Uchar	1	H+52
13	#solnSVs	Number of satellites in solution	Uchar	1	H+53
14	#obs	Number of satellites above elevation mask angle	Uchar	1	H+54
15	#multi	Number of satellites above elevation mask angle with L2, B2	Uchar	1	H+55
16	Reserved		Hex	1	H+56
17	ext sol stat	Extended solution status, see <i>Table 69: Extended Solution Status</i> on page 378	Hex	1	H+57
18	Galileo and BeiDou sig mask	Galileo and BeiDou signals used mask (see <i>Table 68: Galileo and BeiDou Signal-Used Mask</i> on page 378)	Hex	1	H+58
19	GPS and GLONASS sig mask	GPS and GLONASS signals used mask (see <i>Table 67: GPS and GLONASS Signal-Used Mask</i> on page 377)	Hex	1	H+59
20	xxxx	32-bit CRC (ASCII and Binary only)	Hex	4	H+60
21	[CR][LF]	Sentence Terminator (ASCII only)	-	-	-

3.3 ALIGNBSLNXYZ

XYZ baselines using ALIGN

Platform: OEM719, OEM729, OEM7500, OEM7600, OEM7700, OEM7720, PwrPak7, SPAN CPT7, SMART7

This log outputs the RTK quality XYZ baselines from ALIGN.



On dual antenna receivers, the baseline vector from the primary to the secondary antenna is provided. Additionally, with an ALIGN Relative Positioning model, the baseline vector from an external base station to the primary antenna is also available. The baseline vector from an external base station to the secondary antenna is not available.

Message ID: 1314

Log Type: Asynch

Recommended Input:

```
log alignbslnxyza onnew
```

ASCII Example:

```
#ALIGNBSLNXYZA, COM1, 0, 29.0, FINESTEERING, 1629, 259250.000, 02040000, 9d28, 39448;
SOL_COMPUTED, NARROW_INT, 3.1901, -3.0566, 1.2079, 0.0050, 0.0054, 0.0056, "0092",
"AAAA", 22, 16, 16, 16, 0, 01, 0, 33*ac372198
```

Field	Field type	Description	Format	Binary Bytes	Binary Offset
1	ALIGNBSLNXYZ	Log header. See <i>Messages</i> on page 27 for more information.		H	0
2	sol stat	Solution status, see <i>Table 65: Solution Status</i> on page 374	Enum	4	H
3	pos type	Position type, see <i>Table 66: Position or Velocity Type</i> on page 375	Enum	4	H+4
4	dX	X Baseline in meters	Double	8	H+8
5	dY	Y Baseline in meters	Double	8	H+16
6	dZ	Z Baseline in meters	Double	8	H+24
7	dX σ	X Baseline standard deviation in meters	Float	4	H+32
8	dY σ	Y Baseline standard deviation in meters	Float	4	H+36
9	dZ σ	Z Baseline standard deviation in meters	Float	4	H+40

Field	Field type	Description	Format	Binary Bytes	Binary Offset
10	Rover id	Rover Receiver ID Set using SETROVERID command (see page 287) on the Rover e.g. SETROVERID RRRR	Uchar [4]	4	H+44
11	Master id	Master Receiver Id Set using the DGPSTXID command (see page 105) on the Master Default: AAAA	Uchar [4]	4	H+48
12	#SVs	Number of satellites tracked	Uchar	1	H+52
13	#solnSVs	Number of satellites in solution	Uchar	1	H+53
14	#obs	Number of satellites above elevation mask angle	Uchar	1	H+54
15	#multi	Number of satellites above elevation mask angle with L2, B2	Uchar	1	H+55
16	Reserved		Hex	1	H+56
17	ext sol stat	Extended solution status, see <i>Table 69: Extended Solution Status</i> on page 378	Hex	1	H+57
18	Galileo and BeiDou sig mask	Galileo and BeiDou signals used mask (see <i>Table 68: Galileo and BeiDou Signal-Used Mask</i> on page 378)	Hex	1	H+58
19	GPS and GLONASS sig mask	GPS and GLONASS signals used mask (see <i>Table 67: GPS and GLONASS Signal-Used Mask</i> on page 377)	Hex	1	H+59
20	xxxx	32-bit CRC (ASCII and Binary only)	Hex	4	H+60
21	[CR][LF]	Sentence Terminator (ASCII only)	-	-	-

3.4 ALIGNDOP

Calculated DOP values

Platform: OEM719, OEM729, OEM7500, OEM7600, OEM7700, OEM7720, PwrPak7, SPAN CPT7, SMART7

This log outputs the DOP computed using the satellites used in the heading solution. This log comes out at a default 1 Hz rate. Additional logs may be output not on the even second if the DOP changes and ALIGN is operating at greater than 1 Hz.

Message ID: 1332

Log Type: Asynch

Recommended Input:

```
log aligndopa onnew
```

ASCII Example:

```
#ALIGNDOPA,COM1,0,22.5,FINESTEERING,1629,259250.000,02040000,de2d,39448;1.6160,
1.2400,0.6900,0.9920,0.7130,10.0,16,4,32,23,10,7,20,13,30,16,47,43,46,53,54,44,
45*90a72971
```

Field	Field type	Description	Format	Binary Bytes	Binary Offset
1	ALIGNDOP	Log header. See <i>Messages</i> on page 27 for more information.		H	0
2	GDOP	Geometric DOP	Float	4	H
3	PDOP	Position DOP	Float	4	H+4
4	HDOP	Horizontal DOP	Float	4	H+8
5	HTDOP	Horizontal and time DOP	Float	4	H+12
6	TDOP	Time DOP	Float	4	H+16
7	Elev mask	Elevation mask angle	Float	4	H+20
8	#sats	Number of satellites to follow	Ulong	4	H+24
9	sats	Satellites in use at time of calculation	Ulong	4	H+28
10	Next sat offset = H+28+(#sats * 4)				
11	xxxx	32-bit CRC (ASCII and Binary only)	Hex	4	H+28+ (#sats * 4)
12	[CR][LF]	Sentence terminator (ASCII only)	-	-	-

3.5 ALMANAC

Decoded GPS L1 C/A Almanac

Platform: OEM719, OEM729, OEM7500, OEM7600, OEM7700, OEM7720, PwrPak7, SPAN CPT7, SMART7, SMART2

This log contains the decoded GPS almanac parameters from L1 C/A subframes four and five, as received from the satellite, with the parity information removed and appropriate scaling applied. For more information about almanac data, refer to the GPS SPS Signal Specification.

The OEM7 family of receivers automatically save almanacs in their Non-Volatile Memory (NVM), so creating an almanac boot file is not necessary.

Message ID: 73

Log Type: Asynch

Recommended Input:

log almanaca onchanged

ASCII Example:

```
#ALMANACA,COM1,0,81.5,SATTIME,2061,161544.000,02000020,06de,15340;
31,
1,2061,319488.0,9.024620e-03,-7.72603611e-09,2.5520875e+00,7.32573573e-01,
1.0417636e+00,-6.38961792e-05,-1.09139364e-11,1.45859650e-04,2.6559659e+07,
3.39033723e-02,3,0,0,TRUE,
2,2061,319488.0,1.892567e-02,-7.92032991e-09,2.4824476e+00,-1.7306367e+00,
1.3164810e+00,-2.57492065e-04,-7.27595761e-12,1.45852146e-04,2.6560570e+07,
1.29609392e-02,1,0,0,TRUE,
3,2061,319488.0,2.330303e-03,-7.98890420e-09,-2.6893473e+00,6.35680740e-01,
4.78796000e-02,1.82151794e-04,-3.63797881e-12,1.45852022e-04,2.6560585e+07,
2.09664015e-02,3,0,0,TRUE,
...
30,2061,319488.0,4.143715e-03,-8.06890753e-09,-5.53781670e-01,-2.9358273e+00,
4.13367750e-01,-1.40190125e-04,-7.27595761e-12,1.45849120e-04,2.6560938e+07,
-1.79763374e-03,3,0,0,TRUE,
31,2061,319488.0,9.235382e-03,-7.88604277e-09,-5.67069929e-01,9.71920640e-03,
1.02299965e-01,2.47955322e-05,-3.63797881e-12,1.45860314e-04,2.6559579e+07,
1.72872444e-02,2,0,0,TRUE,
32,2061,319488.0,3.180504e-03,-7.85175563e-09,-1.6503499e+00,-2.4786853e+00,
-2.4002616e+00,-8.58306885e-06,1.45519152e-11,1.45864294e-04,2.6559096e+07,
1.38717403e-02,3,0,0,TRUE*80c86a68
```



The speed at which the receiver locates and locks onto new satellites is improved if the receiver has approximate time and position (**SETAPPROXTIME** and **SETAPPROXPOS**), as well as an almanac. This allows the receiver to compute the elevation of each satellite so it can tell which satellites are visible and their Doppler offsets, improving Time to First Fix (TTFF).

Field	Field type	Description	Format	Binary Bytes	Binary Offset
1	ALMANAC	Log header. See <i>Messages</i> on page 27 for more information.		H	0
2	#messages	The number of satellite PRN almanac messages to follow. Set to zero until almanac data is available	Long	4	H
3	PRN	Satellite PRN number for current message (dimensionless)	Ulong	4	H+4
4	week	Almanac reference week (GPS reference week number)	Ulong	4	H+8
5	seconds	Almanac reference time (seconds into the week)	Double	8	H+12
6	ecc	Eccentricity (dimensionless)	Double	8	H+20
7	$\dot{\omega}$	Rate of right ascension (radians/second)	Double	8	H+28
8	ω_0	Right ascension (radians)	Double	8	H+36
9	ω	Argument of perigee (radians)	Double	8	H+44
10	M_0	Mean anomaly of reference time (radians)	Double	8	H+52
11	a_{f0}	Clock aging parameter (seconds)	Double	8	H+60
12	a_{f1}	Clock aging parameter (seconds/second)	Double	8	H+68
13	N_0	Computed mean motion (radians/second)	Double	8	H+76
14	A	Semi-major axis (meters)	Double	8	H+84
15	incl-angle	Angle of inclination relative to 0.3π (radians)	Double	8	H+92
16	SV config	Satellite configuration	Ulong	4	H+100
17	health-prn	SV health from Page 25 of subframe 4 or 5 (6 bits)	Ulong	4	H+104
18	health-alm	SV health from almanac (8 bits)	Ulong	4	H+108
19	antispoof	Anti-spoofing on? 0 = FALSE 1 = TRUE	Bool	4	H+112
20...	Next PRN offset = H + 4 + (#messages x 112)				

Field	Field type	Description	Format	Binary Bytes	Binary Offset
21	xxxx	32-bit CRC (ASCII and Binary only)	Hex	4	H + 4 + (112 x #messages)
22	[CR][LF]	Sentence terminator (ASCII only)	-	-	-

3.6 AUTHCODES

List of authorization codes

Platform: OEM719, OEM729, OEM7500, OEM7600, OEM7700, OEM7720, PwrPak7, SPAN CPT7, SMART7, SMART2

This log contains all authorization codes (auth codes) entered into the system since the last complete firmware reload. Signature authorization codes will be maintained through a SoftLoad. The log also indicates the status of the firmware signature. For more information about firmware signatures see the "Upgrading Using the AUTH Command" section of the [OEM7 Installation and Operation User Manual](#).



The following situations will cause an authorization code to be marked invalid:

- Authorization Code is for a different receiver
- Authorization Code has expired
- Authorization Code was entered incorrectly

If you require new authorization codes, contact NovAtel Customer Service.

Message ID: 1348

Log Type: Polled

Recommended Input:

```
log authcodesa once
```

ASCII Example:

```
#AUTHCODESA,COM1,0,80.5,UNKNOWN,0,10.775,024c0000,2ad2,12143;VALID,2,SIGNATURE,TRUE,"63F3K8,MX43GD,T4BJ2X,924RRB,BZRWB,T,D2SB0G550",STANDARD,TRUE,"CJ43M9,2RNDBH,F3PDK8,N88F44,8JMKK9,D2SB0G550"*6f778e32
```

Field	Field type	Description	Format	Binary Bytes	Binary Offset
1	AUTHCODES header	Log header. See <i>Messages</i> on page 27 for more information.		H	0
2	AUTHCODES Signature Status	Status of the Firmware Signature 1 = NONE 2 = INVALID 3 = VALID 4 = RESERVED 5 = HIGH_SPEED	Enum	4	H
3	Number of Auth Codes	# of Auth Codes to follow (max is 24)	Ulong	4	H+4

Field	Field type	Description	Format	Binary Bytes	Binary Offset
4	Auth code type	1=STANDARD 2=SIGNATURE 3=EMBEDDED	Enum	4	H+8
5	Valid	TRUE if the Auth Code has been verified	Bool	4	H+12
6	Auth Code String	ASCII String of the Auth Code	String [max 80]	variable ¹	H+16
7...	Next AuthCode = H+8+ (#AuthCodes*variable)				
8	xxxx	32-bit CRC (ASCII and Binary only)	Hex	4	H+8+ (#AuthCodes*variable)
9	[CR][LF]	Sentence terminator (ASCII only)	-	-	-

¹In the binary case, each string field needs to be NULL terminated and additional bytes of padding added to maintain 4-byte alignment, up to the maximum defined by the string size. The next defined field starts immediately at the next 4-byte alignment following the NULL.

3.7 AVEPOS

Position averaging

Platform: OEM719, OEM729, OEM7500, OEM7600, OEM7700, OEM7720, PwrPak7, SPAN CPT7, SMART7, SMART2

When position averaging is underway, the various fields in the AVEPOS log contain the parameters being used in the position averaging process. *Table 62: Position Averaging Status* on the next page shows the possible position averaging status values seen in field #8 of the AVEPOS log table.

See the description of the **POSAVE** command on page 211. For general positioning information, refer to [An Introduction to GNSS](#) available on our website.



Asynchronous logs should only be logged ONCHANGED. Otherwise, the most current data is not output when it is available. This is especially true of the ONTIME trigger, which may cause inaccurate time tags to result.

Message ID: 172

Log Type: Asynch

Recommended Input:

```
log aveposa onchanged
```

ASCII Example:

```
#AVEPOSA,COM1,0,48.5,FINESTEERING,1364,492100.000,82000000,e3b4,2310;
51.11635589900,-114.03833558937,1062.216134356,1.7561,0.7856,1.7236,
INPROGRESS,2400,2*72a550c1
```



When a GNSS position is computed, there are four unknowns being solved: latitude, longitude, height and receiver clock offset (often just called time). The solutions for each of the four unknowns are correlated to satellite positions in a complex way. Since satellites are above the antenna (none are below) there is a geometric bias. Therefore, geometric biases are present in the solutions and affect the computation of height. These biases are called DOPs (Dilution Of Precision). Smaller biases are indicated by low DOP values. VDOP (Vertical DOP) pertains to height. Most of the time, VDOP is higher than HDOP (Horizontal DOP) and TDOP (Time DOP). Therefore, of the four unknowns, height is the most difficult to solve. Many GNSS receivers output the Standard Deviations (SD) of the latitude, longitude and height. Height often has a larger value than the other two.

Accuracy is based on statistics and reliability is measured in percent. When a receiver states it can measure height to one meter, this is an accuracy. Usually this is a one sigma value (one SD). A one sigma value for height has a reliability of 68%. In other words, the error is less than one meter 68% of the time. For a more realistic accuracy, double the one sigma value (one meter) and the result is 95% reliability (error is less than two meters 95% of the time). Generally, GNSS heights are 1.5 times poorer than horizontal positions. See also **GPGST** log on page 455 for CEP and RMS definitions.

Field	Field type	Description	Format	Binary Bytes	Binary Offset
1	AVEPOS header	Log header. See <i>Messages</i> on page 27 for more information.		H	0
2	lat	Average WGS84 latitude (degrees)	Double	8	H
3	lon	Average WGS84 longitude (degrees)	Double	8	H+8
4	hgt	Average height above sea level (m)	Double	8	H+16
5	lat σ	Estimated average standard deviation of latitude solution element (m)	Float	4	H+24
6	lon σ	Estimated average standard deviation of longitude solution element (m)	Float	4	H+28
7	hgt σ	Estimated average standard deviation of height solution element (m)	Float	4	H+32
8	posave	Position averaging status (see <i>Table 62: Position Averaging Status</i> below)	Enum	4	H+36
9	ave time	Elapsed time of averaging (s)	Ulong	4	H+40
10	#samples	Number of samples in the average	Ulong	4	H+44
11	xxxx	32-bit CRC (ASCII and Binary only)	Hex	4	H+48
12	[CR][LF]	Sentence terminator (ASCII only)	-	-	-

Table 62: Position Averaging Status

Binary	ASCII	Description
0	OFF	Receiver is not averaging
1	INPROGRESS	Averaging is in progress
2	COMPLETE	Averaging is complete

3.8 BDSALMANAC

Decoded BDS Almanac

Platform: OEM719, OEM729, OEM7500, OEM7600, OEM7700, OEM7720, PwrPak7, SPAN CPT7, SMART7, SMART2

This log contains the decoded BeiDou B1I almanac parameters, with the parity information removed and appropriate scaling applied. Multiple messages are transmitted, one for each SV almanac collected. For more information about almanac data, refer to the BDS Signal Specification.

The OEM7 family of receivers automatically save almanacs in their Non-Volatile Memory (NVM), so creating an almanac boot file is not necessary.

Message ID: 1584

Log Type: Asynch

Recommended Input:

```
log bdsalmanaca onchanged
```

ASCII Example:

```
#BDSALMANACA, COM1, 13, 88.5, SATTIME, 1727, 518438.000, 02000000, 24ad, 44226;1, 371, 245760, 6493.394531, 2.9134750366e-04, -2.289514637, -0.021819903, -2.456844003, 1.30291141e-09, 2.7785425443e-02, -1.096725e-04, 2.18279e-11, 0*77017e1b
```

...

```
#BDSALMANACA, COM1, 0, 88.5, SATTIME, 1727, 518108.000, 02000000, 24ad, 44226;14, 371, 217088, 5282.558105, 1.4486312866e-03, -2.970093901, 2.846651891, 1.512957087, -6.91457373e-09, 1.7820542434e-02, 7.438660e-05, 0.00000, d8*ce944672
```

Field	Field Type	Description	Format	Binary Bytes	Binary Offset
1	BDSALMANAC header	Log header. See <i>Messages</i> on page 27 for more information.		H	0
2	satellite ID	Satellite ID/ranging code	Ulong	4	H
3	week	BeiDou week number	Ulong	4	H+4
4	toa	Time of almanac (s)	Ulong	4	H+8
5	RootA	Square root of semi-major axis (sqrt(m))	Double	8	H+12
6	ecc	Eccentricity (dimensionless)	Double	8	H+20
7	ω	Argument of perigee (radians)	Double	8	H+28
8	M_0	Mean anomaly at reference time (radians)	Double	8	H+36

Field	Field Type	Description	Format	Binary Bytes	Binary Offset
9	Ω	Longitude of ascending node of orbital of plane computed according to reference time (radians)	Double	8	H+44
10	$\dot{\Omega}$	Rate of right ascension (radians/s)	Double	8	H+52
11	δ_i	Correction of orbit reference inclination at reference time (radians)	Double	8	H+60
12	a_0	Constant term of clock correction polynomial (s)	Double	8	H+68
13	a_1	Linear term of clock correction polynomial (s/s)	Double	8	H+76
14	health	Satellite health information	Ulong	4	H+84
15	xxxx	32-bit CRC (ASCII and Binary only)	Hex	4	H+88
16	[CR][LF]	Sentence terminator (ASCII only)	-	-	-

3.9 BDSCLOCK

BeiDou time parameters

Platform: OEM719, OEM729, OEM7500, OEM7600, OEM7700, OEM7720, PwrPak7, SPAN CPT7, SMART7, SMART2

This log contains time parameters transmitted by the BeiDou satellites. These parameters can be used to calculate the offset between BeiDou time (BDT) and other time frames.

Message ID: 1607

Log Type: Asynch

Recommended Input:

```
log bdslocka onchanged
```

ASCII Example:

```
#BDSCLOCKA, COM1, 0, 80.0, SATTIME, 1730, 193994.000, 02000000, 3b16, 44290;
-9.313225746154785e-010, -8.881784197001252e-016, 2, 6, 0, 2,
0.0000000000000000e+000, 0.0000000000000000e+000, 0.0000000000000000e+000,
0.0000000000000000e+000, 0.0000000000000000e+000, 0.0000000000000000e+000
*84820676
```

Field	Field Type	Description	Format	Binary Bytes	Binary Offset
1	BDSCLOCK header	Log header. See <i>Messages</i> on page 27 for more information.		H	0
2	A _{0UTC}	BDT clock bias relative to UTC (s)	Double	8	H
3	A _{1UTC}	BDT clock rate relative to UTC (s/s)	Double	8	H+8
4	ΔT _{LS}	Delta time due to leap seconds before the new leap second is effective (s)	Short	2	H+16
5	WN _{LSF}	Week number of the new leap second	Ushort	2	H+18
6	DN	Day number of week of the new leap second	Ushort	2	H+20
7	ΔT _{LSF}	Delta time due to leap seconds after the new leap second effective	Short	2	H+22
8	A _{0GPS}	BDT clock bias relative to GPS time (s)	Double	8	H+24
9	A _{1GPS}	BDT clock rate relative to GPS time (s/s)	Double	8	H+32
10	A _{0Gal}	BDT clock bias relative to Galileo time (s)	Double	8	H+40
11	A _{1Gal}	BDT clock rate relative to Galileo time (s/s)	Double	8	H+48
12	A _{0GLO}	BDT clock bias relative to GLONASS time (s)	Double	8	H+56

Field	Field Type	Description	Format	Binary Bytes	Binary Offset
13	A ₁ GLO	BDT clock rate relative to GLONASS time (s/s)	Double	8	H+64
14	xxxx	32-bit CRC (ASCII and Binary only)	Ulong	4	H+72
15	[CR][LF]	Sentence terminator (ASCII only)	-	-	-

3.10 BDSEPHEMERIS

Decoded BDS ephemeris

Platform: OEM719, OEM729, OEM7500, OEM7600, OEM7700, OEM7720, PwrPak7, SPAN CPT7, SMART7, SMART2

This log contains a single set of BDS B1I ephemeris parameters with appropriate scaling applied. Multiple messages are transmitted, one for each SV ephemeris collected.

Message ID: 1696

Log Type: Asynch

Recommended Input:

```
log bdsephemerisa onchanged
```

ASCII Example:

```
#BDSEPHEMERISA, COM1, 0, 82.5, SATTIME, 1774, 162464.000, 02000000, 2626, 45436;
13, 418, 2.00, 1, 8.20e-09, 3.10e-09, 11, 162000, 2.33372441e-04, 5.73052716e-12,
8.53809211e-19, 12, 162000, 5282.609060, 2.3558507673e-03, 3.122599126,
4.1744595973e-09, -0.654635278, 1.950232658e+00, -6.98564812e-09, 9.5674299203e-01,
3.164417525e-10, 4.325527698e-06, 8.850824088e-06, 179.3593750, 87.5312500,
7.171183825e-08, 1.024454832e-08*d8b97536
```

Field	Field Type	Description	Format	Binary Bytes	Binary Offset
1	BDSEPHEMERIS header	Log header. See <i>Messages</i> on page 27 for more information.		H	0
2	satellite ID	ID/ranging code	Ulong	4	H
3	Week	BeiDou week number	Ulong	4	H+4
4	URA	User range accuracy (m). This is the evaluated URAI/URA lookup-table value.	Double	8	H+8
5	health 1	Autonomous satellite health flag. 0 means broadcasting satellite is good and 1 means not.	Ulong	4	H+16
6	tgd1	Equipment group delay differential for the B1 signal (s)	Double	8	H+20
7	tgd2	Equipment group delay differential for the B2 signal (s)	Double	8	H+28
8	AODC	Age of data, clock	Ulong	4	H+36
9	toc	Reference time of clock parameters (s)	Ulong	4	H+40
10	a ₀	Constant term of clock correction polynomial (s)	Double	8	H+44

Field	Field Type	Description	Format	Binary Bytes	Binary Offset
11	a_1	Linear term of clock correction polynomial (s/s)	Double	8	H+52
12	a_2	Quadratic term of clock correction polynomial (s/s ²)	Double	8	H+60
13	AODE	Age of data, ephemeris	Ulong	4	H+68
14	toe	Reference time of ephemeris parameters (s)	Ulong	4	H+72
15	RootA	Square root of semi-major axis (sqrt(m))	Double	8	H+76
16	ecc	Eccentricity (dimensionless)	Double	8	H+84
17	ω	Argument of perigee (radians)	Double	8	H+92
18	ΔN	Mean motion difference from computed value (radians/s)	Double	8	H+100
19	M_0	Mean anomaly at reference time (radians)	Double	8	H+108
20	Ω_0	Longitude of ascending node of orbital of plane computed according to reference time (radians)	Double	8	H+116
21	$\dot{\Omega}$	Rate of right ascension (radians/s)	Double	8	H+124
22	i_0	Inclination angle at reference time (radians)	Double	8	H+132
23	IDOT	Rate of inclination angle (radians/second)	Double	8	H+140
24	c_{uc}	Amplitude of cosine harmonic correction term to the argument of latitude (radians)	Double	8	H+148
25	c_{us}	Amplitude of sine harmonic correction term to the argument of latitude (radians)	Double	8	H+156
26	c_{rc}	Amplitude of cosine harmonic correction term to the orbit radius (m)	Double	8	H+164
27	c_{rs}	Amplitude of sine harmonic correction term to the orbit radius (m)	Double	8	H+172
28	c_{ic}	Amplitude of cosine harmonic correction term to the angle of inclination (radians)	Double	8	H+180
29	c_{is}	Amplitude of sine harmonic correction term to the angle of inclination (radians)	Double	8	H+188
30	xxxx	32-bit CRC (ASCII and Binary only)	Ulong	4	H+196
31	[CR][LF]	Sentence terminator (ASCII only)	-	-	-

3.11 BDSIONO

BeiDou Klobuchar ionosphere delay model

Platform: OEM719, OEM729, OEM7500, OEM7600, OEM7700, OEM7720, PwrPak7, SPAN CPT7, SMART7, SMART2

This log contains the Klobuchar ionosphere model parameters transmitted by the BeiDou satellites.

Message ID: 1590

Log Type: Asynch

Recommended Input:

```
log bdsionoa onchanged
```

ASCII Example:

```
#BDSIONOA,COM1,0,80.0,SATTIME,1734,58094.000,02080000,1956,44836;6,
2.607703208923340e-008,4.097819328308105e-007,-3.695487976074218e-006,
7.212162017822263e-006,69632.0,360448.0,-524288.0,-327680.0*69c2a6c6
```

Field	Field Type	Description	Format	Binary Bytes	Binary Offset
1	BDSIONO Header	Log header. See <i>Messages</i> on page 27 for more information.		H	0
2	ID	Transmitting satellite ID	Ulong	4	H
3	α_0	Alpha parameter constant term	Double	8	H+4
4	α_1	Alpha parameter 1st order term	Double	8	H+12
5	α_2	Alpha parameter 2nd order term	Double	8	H+20
6	α_3	Alpha parameter 3rd order term	Double	8	H+28
7	β_0	Beta parameter constant term	Double	8	H+36
8	β_1	Beta parameter 1st order term	Double	8	H+44
9	β_2	Beta parameter 2nd order term	Double	8	H+52
10	β_3	Beta parameter 3rd order term	Double	8	H+60
11	xxxx	32-bit CRC (ASCII and Binary only)	Ulong	4	H+68
12	[CR][LF]	Sentence terminator (ASCII only)	-	-	-

3.12 BDSRAWNAVSUBFRAME

Raw BeiDou subframe data

Platform: OEM719, OEM729, OEM7500, OEM7600, OEM7700, OEM7720, PwrPak7, SPAN CPT7, SMART7, SMART2

This log contains the raw BeiDou subframe data with parity bits removed. Only subframes that have passed the parity check are output.

Message ID: 1695

Log Type: Asynch

Recommended Input:

```
log bdsrawnavsubframea onchanged
```

ASCII Example:

```
#BDSRAWNAVSUBFRAMEA,COM1,0,85.5,SATTIME,1774,162554.000,02000000,88f3,45436;84,13,B1D1,1,e24049ebb2b00d113c685207c4d0ee9fd1bf364e41f8f4b57003268c*6b1f478b
```

Field	Field Type	Description	Format	Binary Bytes	Binary Offset
1	BDSRAWNAVSUBFRAME header	Log header. See <i>Messages</i> on page 27 for more information.		H	0
2	signal channel	Signal channel number	Ulong	4	H
3	satellite ID	Satellite ID	Ulong	4	H+4
4	data source	Source of data (refer to <i>Table 63: Data Source</i> below)	Enum	4	H+8
5	subframe ID	Subframe identifier	Ulong	4	H+12
6	raw subframe data	Framed raw navigation bits	Hex[28]	28	H+16
7	xxxx	32-bit CRC (ASCII and Binary only)	Hex	4	H+44
8	[CR][LF]	Sentence terminator (ASCII only)	-	-	-

Table 63: Data Source

ASCII	Binary	Description
B1D1	0	Data is from a B1I/D1 signal
B1D2	1	Data is from a B1I/D2 signal
B2D1	65536	Data is from a B2I/D1 signal
B2D2	65537	Data is from a B2I/D2 signal

3.13 BESTDATUMINFO

Datum information for best position

Platform: OEM719, OEM729, OEM7500, OEM7600, OEM7700, OEM7720, PwrPak7, SPAN CPT7, SMART7, SMART2

This log reports the datum and co-ordinate epoch of the solution in the **BESTPOS** log (see page 371). For differential solutions, such as RTK or PSRDIFF, where the base station datum is not known, "UNKNOWN" is reported with an ESPG code of 0. Single-point and SBAS report "ECEF" and code 0.

Message ID: 2305

Log Type: Asynch

Recommended Input:

```
log bestdatuminfoa onchanged
```

ASCII Example:

```
#BESTDATUMINFOA, COM1, 0, 62.5, FINESTEERING, 2044, 508765.000, 02000020, 0c2b, 15427; "ITRF2014", 1165, 2019.202, GOOD*3db57b92
```

Field	Field Type	Description	Format	Binary Bytes	Binary Offset
1	BESTDATUMINFO header	Log header. See <i>Messages</i> on page 27 for more information.	-	H	0
2	datum	Datum of the position being output by the BESTPOS log.	Char [32]	variable	H
3	epsg_code	EPSG code of the datum.	Ulong	4	variable
4	epoch	Co-ordinate epoch (decimal year). Example: 2011.00 = Jan 1, 2011 2011.19 = Mar 11, 2011	Double	8	variable
5	status	Transformation status. See <i>Table 64: Transformation Status</i> on the next page.	Enum	4	variable
6	xxxx	32-bit CRC (ASCII and Binary only)	Hex	4	variable
7	[CR][LF]	Sentence terminator (ASCII only)	-	-	-

Table 64: Transformation Status

Binary	ASCII	Description
0	GOOD	An exact transformation was found and used.
1	ECEF_EQUIVALENCY	An exact transformation could not be found, but a similar transformation involving another Earth-fixed transformation was found and used.
2	SERVICE_DETAILS_UNKNOWN	The datum of the input solution was not known and therefore a transformation could not take place.
3	REQUESTED_TRANSFORMATION_UNAVAILABLE	No transformation could be found to transform the solution into the requested datum.

3.14 BESTGNSSDATUMINFO

Datum information for BESTGNSS position

Platform: OEM719, OEM729, OEM7500, OEM7600, OEM7700, OEM7720, PwrPak7, SPAN CPT7, SMART7, SMART2

This log reports the datum and co-ordinate epoch of the solution in the **BESTGNSSPOSS** log (see page 846). For differential solutions, such as RTK or PSRDIFF, where the base station datum is not known, "UNKNOWN" is reported with an EPSG code of 0. Single-point and SBAS report "ECEF" and code 0.

Message ID: 2302

Log Type: Asynch

Recommended Input:

```
log bestgnssdatuminfoa onchanged
```

ASCII Example:

```
#BESTGNSSDATUMINFOA,COM1,0,75.0,FINESTEERING,2044,509700.000,02000020,1790,15427;"ITRF2014",1165,2019.202,GOOD*a34f668f
```

Field	Field Type	Description	Format	Binary Bytes	Binary Offset
1	BESTGNSSDATUMINFO header	Log header. See <i>Messages</i> on page 27 for more information.	-	H	0
2	datum	Datum of position being output by the BESTGNSSPOSS log.	Char [32]	variable	
3	epsg_code	EPSG code of the datum.	Ulong	4	variable
4	epoch	Co-ordinate epoch (decimal year). Example: 2011.00 = Jan 1, 2011 2011.19 = Mar 11, 2011	Double	8	variable
5	status	Transformation Status. See <i>Table 64: Transformation Status</i> on the previous page.	Enum	4	variable
6	xxxx	32-bit CRC (ASCII and Binary only)	Hex	4	variable
7	[CR][LF]	Sentence terminator (ASCII only)	-	-	-

3.15 BESTPOS

Best position

Platform: OEM719, OEM729, OEM7500, OEM7600, OEM7700, OEM7720, PwrPak7, SPAN CPT7, SMART7, SMART2

When positioning with GNSS, there are four parameters being solved for: latitude, longitude, height and receiver clock offset from GPS time. The quality of the solution for all four parameters depends on the geometry of where the satellites are with respect to the antenna (and receiver). The strength of the positioning geometry is indicated by Dilution of Precision (DOP) values, with lower DOP numbers indicating better geometry. Because all the GNSS satellites are above terrestrial receivers, the VDOP (vertical DOP) is the largest DOP value. This is why the reported standard deviation for height is usually larger than for latitude or longitude.

Accuracy is based on statistics and reliability is measured in percentages. When a receiver states it can measure height to one meter, this is an accuracy measure. Usually this is a one sigma value (one SD). A one sigma value for height has a reliability of 68%. In other words, the error is less than one meter 68% of the time. For a more realistic accuracy, double the one sigma value (one meter) and the result is 95% reliability (error is less than two meters 95% of the time). Generally, GNSS heights are 1.5 times poorer than horizontal positions. See also the note in the **GPGST** log on page 455 for CEP and RMS definitions.

This log contains the best position computed by the receiver. In addition, it reports several status indicators, including differential age, which is useful in predicting anomalous behavior brought about by outages in differential corrections. A differential age of 0 indicates that no differential correction was used.



SPAN Systems

On systems with SPAN enabled, this log contains the best available combined GNSS and Inertial Navigation System (INS - if available) position computed by the receiver.

With the system operating in an RTK mode, BESTPOS reflects the latest low-latency solution for up to 60 seconds after reception of the last base station observation. After this 60 second period, the position reverts to the best solution available and the degradation in accuracy is reflected in the standard deviation fields. If the system is not operating in RTK mode, pseudorange differential solutions continue for the time specified in the **PSRDIFFTIMEOUT** command (see page 227). If the receiver is SPAN enabled, the GNSS+INS combined solution is also a candidate for BESTPOS output.



The RTK system in the receiver provides two kinds of position solutions. The Matched RTK position is computed with buffered observations, so there is no error due to the extrapolation of base station measurements. This provides the highest accuracy solution possible at the expense of some latency which is affected primarily by the speed of the differential data link. The **MATCHEDPOS** log (see page 523) contains the matched RTK solution and can be generated for each processed set of base station observations.

The Low-Latency RTK position is computed from the latest local observations and extrapolated base station observations. This supplies a valid RTK position with the lowest latency possible at the expense of some accuracy. The degradation in accuracy is reflected in the standard deviation and is summarized in [An Introduction to GNSS](#) available on our website. The amount of time that the base station observations are extrapolated is in the "differential age" field of the position log. The Low-Latency RTK system extrapolates for 60 seconds. The **RTKPOS** log (see page 674) contains the Low-Latency RTK position when valid, and an "invalid" status when a Low-Latency RTK solution could not be computed. The **BESTPOS** log contains either the low-latency RTK, PPP or pseudorange-based position, whichever has the smallest standard deviation.

RTK positioning uses the carrier phase observations from the receiver. The carrier phases are precise but ambiguous: the measurement includes an unknown integer number of cycles known as the "ambiguities". Determining these ambiguities is the key to unlocking the highest-accuracy GNSS positions. This determination is known as ambiguity resolution. Before the integer ambiguities can be resolved they are first estimated as real-numbered values, "floats" in computing parlance. After some period that depends on RTK baseline length, ionosphere activity, and other observing conditions, the ambiguities can be resolved into integers, making centimeter or even sub-centimeter positioning possible.



Different positioning modes have different maximum logging rates, which are also controlled by model option. The maximum rates are: 100 Hz for RTK, 100 Hz for pseudorange based positioning, 20 Hz for GLIDE (PDP) and 20 Hz for PPP.



On SMART antenna, the position in the **BESTPOS** log may be corrected for antenna height. If so this will be indicated in the Extended Solution Status. See Terrain Compensation in the [SMART7 Installation and Operation User Manual](#) for details.

Message ID: 42

Log Type: Synch

Recommended Input:

```
log bestposa ontime 1
```

ASCII Example 1:

```
#BESTPOSA, COM1, 0, 90.5, FINESTEERING, 1949, 403742.000, 02000000, b1f6, 32768;  
SOL_COMPUTED, SINGLE, 51.11636937989, -114.03825348307, 1064.533, -16.9000, WGS84,  
1.3610, 1.0236, 2.4745, "", 0.000, 0.000, 19, 19, 19, 19, 00, 06, 00, 33*6e08fa22
```

ASCII Example 2:

```
#BESTPOSA,COM1,0,78.5,FINESTEERING,1419,336208.000,02000040,6145,2724;
SOL_COMPUTED,NARROW_INT,51.11635910984,-114.03833105168,1063.8416,-16.2712,
WGS84,0.0135,0.0084,0.0172,"AAAA",1.000,0.000,8,8,8,8,0,01,0,03*3d9fbd48
```

Field	Field type	Description	Format	Binary Bytes	Binary Offset
1	BESTPOS header	Log header. See <i>Messages</i> on page 27 for more information.		H	0
2	sol stat	Solution status, see <i>Table 65: Solution Status</i> on the next page	Enum	4	H
3	pos type	Position type, see <i>Table 66: Position or Velocity Type</i> on page 375	Enum	4	H+4
4	lat	Latitude (degrees)	Double	8	H+8
5	lon	Longitude (degrees)	Double	8	H+16
6	hgt	Height above mean sea level (meters)	Double	8	H+24
7	undulation	<p>Undulation - the relationship between the geoid and the ellipsoid (m) of the chosen datum</p> <div style="border: 1px solid black; padding: 5px; margin: 10px 0;">  <p>When using a datum other than WGS84, the undulation value also includes the vertical shift due to differences between the datum in use and WGS84.</p> </div>	Float	4	H+32
8	datum id#	<p>Datum ID number</p> <p>61 = WGS84</p> <p>63 = USER</p>	Enum	4	H+36
9	lat σ	Latitude standard deviation (m)	Float	4	H+40
10	lon σ	Longitude standard deviation (m)	Float	4	H+44
11	hgt σ	Height standard deviation (m)	Float	4	H+48
12	stn id	Base station ID	Char[4]	4	H+52
13	diff_age	Differential age in seconds	Float	4	H+56
14	sol_age	Solution age in seconds	Float	4	H+60
15	#SVs	Number of satellites tracked	Uchar	1	H+64
16	#solnSVs	Number of satellites used in solution	Uchar	1	H+65
17	#solnL1SVs	Number of satellites with L1/E1/B1 signals used in solution	Uchar	1	H+66

Field	Field type	Description	Format	Binary Bytes	Binary Offset
18	#solnMultiSVs	Number of satellites with multi-frequency signals used in solution	Uchar	1	H+67
19	Reserved		Hex	1	H+68
20	ext sol stat	Extended solution status (see <i>Table 69: Extended Solution Status</i> on page 378)	Hex	1	H+69
21	Galileo and BeiDou sig mask	Galileo and BeiDou signals used mask (see <i>Table 68: Galileo and BeiDou Signal-Used Mask</i> on page 378)	Hex	1	H+70
22	GPS and GLONASS sig mask	GPS and GLONASS signals used mask (see <i>Table 67: GPS and GLONASS Signal-Used Mask</i> on page 377)	Hex	1	H+71
23	xxxx	32-bit CRC (ASCII and Binary only)	Hex	4	H+72
24	[CR][LF]	Sentence terminator (ASCII only)	-	-	-

Table 65: Solution Status

Binary	ASCII	Description
0	SOL_COMPUTED	Solution computed
1	INSUFFICIENT_OBS	Insufficient observations
2	NO_CONVERGENCE	No convergence
3	SINGULARITY	Singularity at parameters matrix
4	COV_TRACE	Covariance trace exceeds maximum (trace > 1000 m)
5	TEST_DIST	Test distance exceeded (maximum of 3 rejections if distance >10 km)
6	COLD_START	Not yet converged from cold start
7	V_H_LIMIT	Height or velocity limits exceeded (in accordance with export licensing restrictions)
8	VARIANCE	Variance exceeds limits
9	RESIDUALS	Residuals are too large
10-12	Reserved	
13	INTEGRITY_WARNING	Large residuals make position unreliable
14-17	Reserved	

Binary	ASCII	Description
18	PENDING	<p>When a FIX position command is entered, the receiver computes its own position and determines if the fixed position is valid</p> <div style="border: 1px solid black; padding: 10px; margin: 10px 0;">  <p>PENDING implies there are not enough satellites currently tracked to verify if the FIX POSITION entered into the receiver is valid. Under normal conditions, you should only see PENDING for a few seconds on power up before the GNSS receiver has locked onto its first few satellites. If your antenna is obstructed (or not plugged in) and you have entered a FIX POSITION command, then you may see PENDING indefinitely.</p> </div>
19	INVALID_FIX	The fixed position, entered using the FIX position command, is not valid
20	UNAUTHORIZED	Position type is unauthorized
21	Reserved	
22	INVALID_RATE	The selected logging rate is not supported for this solution type.

Table 66: Position or Velocity Type

Binary	ASCII	Description
0	NONE	No solution
1	FIXEDPOS	Position has been fixed by the FIX position command or by position averaging.
2	FIXEDHEIGHT	Position has been fixed by the FIX height or FIX auto command or by position averaging
3-7	Reserved	
8	DOPPLER_VELOCITY	Velocity computed using instantaneous Doppler
9-15	Reserved	
16	SINGLE	Solution calculated using only data supplied by the GNSS satellites
17	PSRDIFF	Solution calculated using pseudorange differential (DGPS, DGNSS) corrections
18	WAAS	Solution calculated using corrections from an SBAS satellite
19	PROPAGATED	Propagated by a Kalman filter without new observations
20-31	Reserved	

Binary	ASCII	Description
32	L1_FLOAT	Single-frequency RTK solution with unresolved, float carrier phase ambiguities
33	Reserved	
34	NARROW_FLOAT	Multi-frequency RTK solution with unresolved, float carrier phase ambiguities
35-47	Reserved	
48	L1_INT	Single-frequency RTK solution with carrier phase ambiguities resolved to integers
49	WIDE_INT	Multi-frequency RTK solution with carrier phase ambiguities resolved to wide-lane integers
50	NARROW_INT	Multi-frequency RTK solution with carrier phase ambiguities resolved to narrow-lane integers
51	RTK_DIRECT_INS	RTK status where the RTK filter is directly initialized from the INS filter
52	INS_SBAS	INS position, where the last applied position update used a GNSS solution computed using corrections from an SBAS (WAAS) solution
53	INS_PSRSP	INS position, where the last applied position update used a single point GNSS (SINGLE) solution
54	INS_PSRDIFF	INS position, where the last applied position update used a pseudorange differential GNSS (PSRDIF) solution
55	INS_RTKFLOAT	INS position, where the last applied position update used a floating ambiguity RTK (L1_FLOAT or NARROW_FLOAT) solution
56	INS_RTKFIXED	INS position, where the last applied position update used a fixed integer ambiguity RTK (L1_INT, WIDE_INT or NARROW_INT) solution
57-67	Reserved	
68	PPP_CONVERGING	Converging TerraStar-C, TerraStar-C PRO or TerraStar-X solution
69	PPP	Converged TerraStar-C, TerraStar-C PRO or TerraStar-X solution
70	OPERATIONAL	Solution accuracy is within UAL operational limit
71	WARNING	Solution accuracy is outside UAL operational limit but within warning limit
72	OUT_OF_BOUNDS	Solution accuracy is outside UAL limits

Binary	ASCII	Description
73	INS_PPP_ CONVERGING	INS position, where the last applied position update used a converging TerraStar-C, TerraStar-C PRO or TerraStar-X PPP (PPP_CONVERGING) solution
74	INS_PPP	INS position, where the last applied position update used a converged TerraStar-C, TerraStar-C PRO or TerraStar-X PPP (PPP) solution
77	PPP_BASIC_ CONVERGING	Converging TerraStar-L solution
78	PPP_BASIC	Converged TerraStar-L solution
79	INS_PPP_ BASIC _CONVERGING	INS position, where the last applied position update used a converging TerraStar-L PPP (PPP_BASIC) solution
80	INS_PPP_ BASIC	INS position, where the last applied position update used a converged TerraStar-L PPP (PPP_BASIC) solution



PPP requires access to a suitable correction stream, delivered either through L-Band or the Internet. For L-Band delivered TerraStar or Veripos service, an L-Band capable receiver and software model is required, along with a subscription to the desired service. Contact NovAtel for TerraStar and Veripos subscription details.

Table 67: GPS and GLONASS Signal-Used Mask

Bit	Mask	Description
0	0x01	GPS L1 used in Solution
1	0x02	GPS L2 used in Solution
2	0x04	GPS L5 used in Solution
3	0x08	Reserved
4	0x10	GLONASS L1 used in Solution
5	0x20	GLONASS L2 used in Solution
6	0x40	GLONASS L3 used in Solution
7	0x80	Reserved

Table 68: Galileo and BeiDou Signal-Used Mask

Bit	Mask	Description
0	0x01	Galileo E1 used in Solution
1	0x02	Galileo E5A used in Solution
2	0x04	Galileo E5B used in Solution
3	0x08	Galileo ALTBOC used in Solution
4	0x10	BeiDou B1 used in Solution
5	0x20	BeiDou B2 used in Solution
6	0x40	BeiDou B3 used in Solution
7	0x80	Reserved

Table 69: Extended Solution Status

Bit	Mask	Description
0	0x01	If an RTK solution: an RTK solution has been verified If a PDP solution: solution is GLIDE Otherwise: Reserved
1-3	0x0E	Pseudorange Iono Correction 0 = Unknown or default Klobuchar model 1 = Klobuchar Broadcast 2 = SBAS Broadcast 3 = Multi-frequency Computed 4 = PSRDiff Correction 5 = NovAtel Blended Iono Value
4	0x10	RTK ASSIST active
5	0x20	0 = No antenna warning 1 = Antenna information is missing
6	0x40	Reserved
7	0x80	0 = Terrain Compensation corrections are not used 1 = Position includes Terrain Compensation corrections

Table 70: Supplemental Position Types and NMEA Equivalents

Value	Documented Enum Name	NMEA Equivalent
68	PPP_CONVERGING	2
69	PPP	5
70	OPERATIONAL	4
71	WARNING	5
72	OUT_OF_BOUNDS	1
77	PPP_BASIC_CONVERGING	1
78	PPP_BASIC	2

3.16 BESTSATS

Satellites used in BESTPOS

Platform: OEM719, OEM729, OEM7500, OEM7600, OEM7700, OEM7720, PwrPak7, SPAN CPT7, SMART7, SMART2

This log lists the used and unused satellites for the corresponding BESTPOS solution. It also describes the signals of the used satellites or reasons for exclusions.

Message ID: 1194

Log Type: Synch

Recommended Input:

```
log bestsats ontime 1
```

Abbreviated ASCII Example:

```
<BESTSATS COM1 0 57.5 FINESTEERING 1729 12132.000 02000000 95e7 11487
< 26
< GPS 3 GOOD 00000003
< GPS 5 GOOD 00000003
...
< GPS 26 GOOD 00000003
< GPS 28 GOOD 00000003
< GLONASS 3+5 GOOD 00000003
< GLONASS 4+6 GOOD 00000003
...
< GLONASS 23+3 GOOD 00000003
< GLONASS 24+2 GOOD 00000003
< BEIDOU 6 GOOD 00000003
< BEIDOU 9 GOOD 00000003
...
< BEIDOU 12 GOOD 00000003
< BEIDOU 13 GOOD 00000003
```

Field	Field type	Description	Format	Binary Bytes	Binary Offset
1	BESTSATS header	Log header. See <i>Messages</i> on page 27 for more information.		H	0
2	#entries	Number of records to follow	Ulong	4	H
3	System	See <i>Table 93: Satellite System</i> on page 477	Enum	4	H+4

Field	Field type	Description	Format	Binary Bytes	Binary Offset
4	Satellite ID	In binary logs, the satellite ID field is 4 bytes. The 2 lowest-order bytes, interpreted as a USHORT, are the system identifier: for instance, the PRN for GPS, Galileo, BeiDou, NavIC and QZSS, or the slot for GLONASS. The 2 highest-order bytes are the frequency channel for GLONASS, interpreted as a SHORT and zero for all other systems. In ASCII and abbreviated ASCII logs, the satellite ID field is the system identifier. If the system is GLONASS and the frequency channel is not zero, then the signed channel is appended to the system identifier. For example, slot 13, frequency channel -2 is output as 13-2.	Ulong	4	H+8
5	Status	Satellite status. See <i>Table 71: Observation Statuses</i> below	Enum	4	H+12
6	Signal mask	See <i>Table 72: BESTSATS GPS Signal Mask</i> on the next page, <i>Table 73: BESTSATS GLONASS Signal Mask</i> on page 383, <i>Table 74: BESTSATS Galileo Signal Mask</i> on page 383 and <i>Table 75: BESTSATS BeiDou Signal Mask</i> on page 383	Hex	4	H+16
7	Next satellite offset = H + 4 + (#entries x 16)				
8	xxxx	32-bit CRC (ASCII and Binary only)	Hex	4	H+4 (#entries x 16)
9	[CR][LF]	Sentence terminator (ASCII only)	-	-	-

Table 71: Observation Statuses

Value	Name	Description
0	GOOD	Observation is good
1	BADHEALTH	Satellite is flagged as bad health in ephemeris or almanac
2	OLDEPHEMERIS	Ephemeris >3 hours old
6	ELEVATIONERROR	Satellite was below the elevation cutoff
7	MISCLOSURE	Observation was too far from predicted value
8	NODIFFCORR	No differential correction available

Value	Name	Description
9	NOEPHEMERIS	No ephemeris available
10	INVALIDIODE	IODE used is invalid
11	LOCKEDOUT	Satellite has been locked out
12	LOWPOWER	Satellite has low signal power
13	OBSL2	An L2 observation not directly used in the solution
15	UNKNOWN	Observation was not used because it was of an unknown type
16	NOIONOCORR	No ionosphere delay correction was available
17	NOTUSED	Observation was not used in the solution
18	OBSL1	An L1 observation not directly used in the solution
19	OBSE1	An E1 observation not directly used in the solution
20	OBSL5	An L5 observation not directly used in the solution
21	OBSE5	An E5 observation not directly used in the solution
22	OBSB2	A B2 observation not directly used in the solution
23	OBSB1	A B1 observation not directly used in the solution
24	OBSB3	A B3 observation not directly used in the solution
25	NOSIGNALMATCH	Signal type does not match
26	SUPPLEMENTARY	Observation contributes supplemental information to the solution
99	NA	No observation available
100	BAD_INTEGRITY	Observation was an outlier and was eliminated from the solution
101	LOSSOFLOCK	Lock was broken on this signal
102	NOAMBIGUITY	No RTK ambiguity type resolved

Table 72: BESTSATS GPS Signal Mask

Bit	Mask	Description
0	0x01	GPS L1 used in Solution
1	0x02	GPS L2 used in Solution
2	0x04	GPS L5 used in Solution

Table 73: BESTSATS GLONASS Signal Mask

Bit	Mask	Description
0	0x01	GLONASS L1 used in Solution
1	0x02	GLONASS L2 used in Solution
2	0x04	GLONASS L3 used in Solution

Table 74: BESTSATS Galileo Signal Mask

Bit	Mask	Description
0	0x01	Galileo E1 used in Solution
1	0x02	Galileo E5A used in Solution
2	0x04	Galileo E5B used in Solution
3	0x08	Galileo ALTBOC used in Solution

Table 75: BESTSATS BeiDou Signal Mask

Bit	Mask	Description
0	0x01	BeiDou B1 used in Solution
1	0x02	BeiDou B2 used in Solution
2	0x04	BeiDou B3 used in Solution

3.17 BESTUTM

Best available UTM data

Platform: OEM719, OEM729, OEM7500, OEM7600, OEM7700, OEM7720, PwrPak7, SPAN CPT7, SMART7, SMART2

This log contains the best available position computed by the receiver in UTM coordinates.

See also the **BESTPOS** log on page 371.



The latitude limits of the UTM System are 80°S to 84°N. If your position is outside this range, the BESTUTM log outputs a northing, easting and height of 0.0, along with a zone letter of '*' and a zone number of 0, to indicate that the data in the log is unusable.

Message ID: 726

Log Type: Synch

Recommended Input:

```
log bestutma ontime 1
```

ASCII Example:

```
#BESTUTMA,COM1,0,73.0,FINESTEERING,1419,336209.000,02000040,eb16,2724;  
SOL_COMPUTED,NARROW_INT,11,U,5666936.4417,707279.3875,1063.8401,-16.2712,WGS84,  
0.0135,0.0084,0.0173,"AAAA",1.000,0.000,8,8,8,8,0,01,0,03*a6d06321
```

Field	Field type	Description	Format	Binary Bytes	Binary Offset
1	BESTUTM header	Log header. See <i>Messages</i> on page 27 for more information.		H	0
2	sol status	Solution status, see <i>Table 65: Solution Status</i> on page 374	Enum	4	H
3	pos type	Position type, see <i>Table 66: Position or Velocity Type</i> on page 375	Enum	4	H+4
4	z#	Longitudinal zone number	Ulong	4	H+8
5	zletter	Latitudinal zone letter	Ulong	4	H+12
6	northing	Northing (m) where the origin is defined as the equator in the northern hemisphere and as a point 10,000,000 meters south of the equator in the southern hemisphere (that is, a 'false northing' of 10,000,000 m)	Double	8	H+16

Field	Field type	Description	Format	Binary Bytes	Binary Offset
7	easting	Easting (m) where the origin is 500,000 m west of the central meridian of each longitudinal zone (that is, a 'false easting' of 500,000 m)	Double	8	H+24
8	hgt	Height above mean sea level (m)	Double	8	H+32
9	undulation	Undulation - the relationship between the geoid and the ellipsoid (m) of the chosen datum <div style="border: 1px solid black; padding: 5px; width: fit-content; margin: 10px auto;">  <p>When using a datum other than WGS84, the undulation value also includes the vertical shift due to differences between the datum in use and WGS84.</p> </div>	Float	4	H+40
10	datum id#	Datum ID number 61 = WGS84 63 = USER	Enum	4	H+44
11	N σ	Northing standard deviation (m)	Float	4	H+48
12	E σ	Easting standard deviation (m)	Float	4	H+52
13	hgt σ	Height standard deviation (m)	Float	4	H+56
14	stn id	Base station ID	Char[4]	4	H+60
15	diff_age	Differential age in seconds	Float	4	H+64
16	sol_age	Solution age in seconds	Float	4	H+68
17	#SVs	Number of satellites tracked	Uchar	1	H+72
18	#solnSVs	Number of satellite vehicles used in solution	Uchar	1	H+73
19	#ggL1	Number of GPS plus GLONASS plus BDS L1/B1 used in solution	Uchar	1	H+74
20	#solnMultiSV	Number of satellites with L1/E1/B1 signals used in solution	Uchar	1	H+75
21	Reserved		Uchar	1	H+76
22	ext sol stat	Extended solution status (see <i>Table 69: Extended Solution Status</i> on page 378)	Hex	1	H+77

Field	Field type	Description	Format	Binary Bytes	Binary Offset
23	Galileo and BeiDou sig mask	Galileo and BeiDou signals used mask (see <i>Table 68: Galileo and BeiDou Signal-Used Mask</i> on page 378)	Hex	1	H+78
24	GPS and GLONASS sig mask	GPS and GLONASS signals used mask (see <i>Table 67: GPS and GLONASS Signal-Used Mask</i> on page 377)	Hex	1	H+79
25	xxxx	32-bit CRC (ASCII and Binary only)	Hex	4	H+80
26	[CR][LF]	Sentence terminator (ASCII only)	-	-	-

3.18 BESTVEL

Best available velocity data

Platform: OEM719, OEM729, OEM7500, OEM7600, OEM7700, OEM7720, PwrPak7, SPAN CPT7, SMART7, SMART2

This log contains the best available velocity information computed by the receiver. In addition, it reports a velocity status indicator, which is needed to determine whether or not the corresponding data is valid. The velocities calculated by the receiver can have a latency associated with them. When present, the velocity time of validity is the time tag in the log minus the latency value.



The velocity is typically from the same source used in the BESTPOS solution. For example, if the BESTPOS is from the pseudorange filter, then the BESTVEL velocity type is the same as for PSRVEL. However, a specific velocity source can be chosen. See the **BESTVELTYPE** command on page 85.



In a BESTVEL log, the actual speed and direction of the receiver antenna over ground is provided. The receiver does not determine the direction a vessel, craft or vehicle is pointed (heading) but rather the direction of motion of the GNSS antenna relative to ground.

The RTK, PDP and PPP velocities are computed from the average change in position over the time interval between consecutive solutions. As such, they are an average velocity based on the time difference between successive position computations and not an instantaneous velocity at the BESTVEL time tag. The velocity latency to be subtracted from the time tag is normally half the time between filter updates. Under default operation, the positioning filters are updated at a rate of 2 Hz. *This average velocity translates into a velocity latency of 0.25 seconds.* To reduce the latency, increase the update rate of the positioning filter being used by requesting the BESTVEL or BESTPOS messages at a rate higher than 2 Hz. For example, a logging rate of 10 Hz would reduce the velocity latency to 0.05 seconds.

If the velocity in the BESTVEL log comes from the pseudorange filter, it has been computed from instantaneous Doppler measurements. You know that you have an instantaneous Doppler derived velocity solution when the velocity type is PSRDIFF, WAAS or DOPPLER_VELOCITY. The instantaneous Doppler derived velocity has low latency and is not position change dependent. If you change your velocity quickly, you can see this in the DOPPLER_VELOCITY solution. Under typically seen dynamics with minimal jerk, the velocity latency is zero. Under extreme, high-jerk dynamics, the latency cannot be well represented: it will still be reported as being zero, but may be as high as 0.15 seconds. Such dynamics are typically only seen in simulated trajectories.

Message ID: 99

Log Type: Synch

Recommended Input:

```
log bestvela ontime 1
```

ASCII Example:

```
#BESTVELA,COM1,0,61.0,FINESTEERING,1337,334167.000,02000000,827b,1984;  
SOL_COMPUTED,PSRDIFF,0.250,4.000,0.0206,227.712486,0.0493,0.0*0e68bf05
```

Field	Field Type	Description	Format	Binary Bytes	Binary Offset
1	BESTVEL header	Log header. See <i>Messages</i> on page 27 for more information.		H	0
2	sol status	Solution status, see <i>Table 65: Solution Status</i> on page 374	Enum	4	H
3	vel type	Velocity type, see <i>Table 66: Position or Velocity Type</i> on page 375	Enum	4	H+4
4	latency	A measure of the latency in the velocity time tag in seconds. It should be subtracted from the time to give improved results (s)	Float	4	H+8
5	age	Differential age in seconds	Float	4	H+12
6	hor spd	Horizontal speed over ground, in meters per second	Double	8	H+16
7	trk gnd	Actual direction of motion over ground (track over ground) with respect to True North, in degrees	Double	8	H+24
8	vert spd	Vertical speed, in meters per second, where positive values indicate increasing altitude (up) and negative values indicate decreasing altitude (down)	Double	8	H+32
9	Reserved		Float	4	H+40
10	xxxx	32-bit CRC (ASCII and Binary only)	Hex	4	H+44
11	[CR][LF]	Sentence terminator (ASCII only)	-	-	-



Velocity (speed and direction) calculations are computed from either Doppler or carrier phase measurements rather than from pseudorange measurements. Typical speed accuracies are around 0.03m/s (0.07 mph, 0.06 knots).

Direction accuracy is derived as a function of the vehicle speed. A simple approach would be to assume a worst case 0.03 m/s cross-track velocity that would yield a direction error function something like:

$$d(\text{speed}) = \tan^{-1}(0.03/\text{speed})$$

For example, if you are flying in an airplane at a speed of 120 knots or 62 m/s, the approximate directional error will be:

$$\tan^{-1}(0.03/62) = 0.03 \text{ degrees}$$

Consider another example applicable to hiking at an average walking speed of 3 knots or 1.5 m/s. Using the same error function yields a direction error of about 1.15 degrees.

You can see from both examples that a faster vehicle speed allows for a more accurate heading indication. As the vehicle slows down, the velocity information becomes less and less accurate. If the vehicle is stopped, a GNSS receiver still outputs some kind of movement at speeds between 0 and 0.5 m/s in random and changing directions. This represents the noise and error of the static position.

In a navigation capacity, the velocity information provided by your GNSS receiver is as, or more, accurate than that indicated by conventional instruments as long as the vehicle is moving at a reasonable rate of speed. It is important to set the GNSS measurement rate fast enough to keep up with all major changes of the vehicle's speed and direction. It is important to keep in mind that although the velocity vector is quite accurate in terms of heading and speed, the actual track of the vehicle might be skewed or offset from the true track by plus or minus 0 to 1.8 meters as per the standard positional errors.

3.19 BESTXYZ

Best available cartesian position and velocity

Platform: OEM719, OEM729, OEM7500, OEM7600, OEM7700, OEM7720, PwrPak7, SPAN CPT7, SMART7, SMART2

This log contains the receiver's best available position and velocity in ECEF coordinates. The position and velocity status fields indicate whether or not the corresponding data is valid. See *Figure 6: The WGS84 ECEF Coordinate System* on page 392, for a definition of the ECEF coordinates.

See also the **BESTPOS** log on page 371 and **BESTVEL** log on page 387.



These quantities are always referenced to the WGS84 ellipsoid, regardless of the use of the **DATUM** command (see page 100) or **USERDATUM** command (see page 325).

Message ID: 241

Log Type: Synch

Recommended Input:

```
log bestxyza ontime 1
```

ASCII Example:

```
#BESTXYZA,COM1,0,55.0,FINESTEERING,1419,340033.000,02000040,d821,2724;  
SOL_COMPUTED,NARROW_INT,-1634531.5683,-3664618.0326,4942496.3270,0.0099,  
0.0219,0.0115,SOL_COMPUTED,NARROW_INT,0.0011,-0.0049,-0.0001,0.0199,0.0439,  
0.0230,"AAAA",0.250,1.000,0.000,12,11,11,11,0,01,0,33*e9eafeca
```

Field	Field type	Description	Format	Binary Bytes	Binary Offset
1	BESTXYZ header	Log header. See <i>Messages</i> on page 27 for more information.		H	0
2	P-sol status	Solution status, see <i>Table 65: Solution Status</i> on page 374	Enum	4	H
3	pos type	Position type, see <i>Table 66: Position or Velocity Type</i> on page 375	Enum	4	H+4
4	P-X	Position X-coordinate (m)	Double	8	H+8
5	P-Y	Position Y-coordinate (m)	Double	8	H+16
6	P-Z	Position Z-coordinate (m)	Double	8	H+24
7	P-X σ	Standard deviation of P-X (m)	Float	4	H+32
8	P-Y σ	Standard deviation of P-Y (m)	Float	4	H+36
9	P-Z σ	Standard deviation of P-Z (m)	Float	4	H+40

Field	Field type	Description	Format	Binary Bytes	Binary Offset
10	V-sol status	Solution status, see <i>Table 65: Solution Status</i> on page 374	Enum	4	H+44
11	vel type	Velocity type, see <i>Table 66: Position or Velocity Type</i> on page 375	Enum	4	H+48
12	V-X	Velocity vector along X-axis (m/s)	Double	8	H+52
13	V-Y	Velocity vector along Y-axis (m/s)	Double	8	H+60
14	V-Z	Velocity vector along Z-axis (m/s)	Double	8	H+68
15	V-X σ	Standard deviation of V-X (m/s)	Float	4	H+76
16	V-Y σ	Standard deviation of V-Y (m/s)	Float	4	H+80
17	V-Z σ	Standard deviation of V-Z (m/s)	Float	4	H+84
18	stn ID	Base station identification	Char[4]	4	H+88
19	V-latency	A measure of the latency in the velocity time tag in seconds. It should be subtracted from the time to give improved results	Float	4	H+92
20	diff_age	Differential age in seconds	Float	4	H+96
21	sol_age	Solution age in seconds	Float	4	H+100
22	#SVs	Number of satellites tracked	Uchar	1	H+104
23	#solnSVs	Number of satellite vehicles used in solution	Uchar	1	H+105
24	#ggL1	Number of GPS plus GLONASS plus BDS L1/B1 used in solution	Uchar	1	H+106
25	#solnMultiSVs	Number of satellites with L1/E1/B1 signals used in solution	Uchar	1	H+107
26	Reserved		Char	1	H+108
27	ext sol stat	Extended solution status (see <i>Table 69: Extended Solution Status</i> on page 378)	Hex	1	H+109
28	Galileo and BeiDou sig mask	Galileo and BeiDou signals used mask (see <i>Table 68: Galileo and BeiDou Signal-Used Mask</i> on page 378)	Hex	1	H+110
29	GPS and GLONASS sig mask	GPS and GLONASS signals used mask (see <i>Table 67: GPS and GLONASS Signal-Used Mask</i> on page 377)	Hex	1	H+111
30	xxxx	32-bit CRC (ASCII and Binary only)	Hex	4	H+112
31	[CR][LF]	Sentence terminator (ASCII only)	-	-	-

Figure 6: The WGS84 ECEF Coordinate System

BIH - Defined CPT (1984.0)

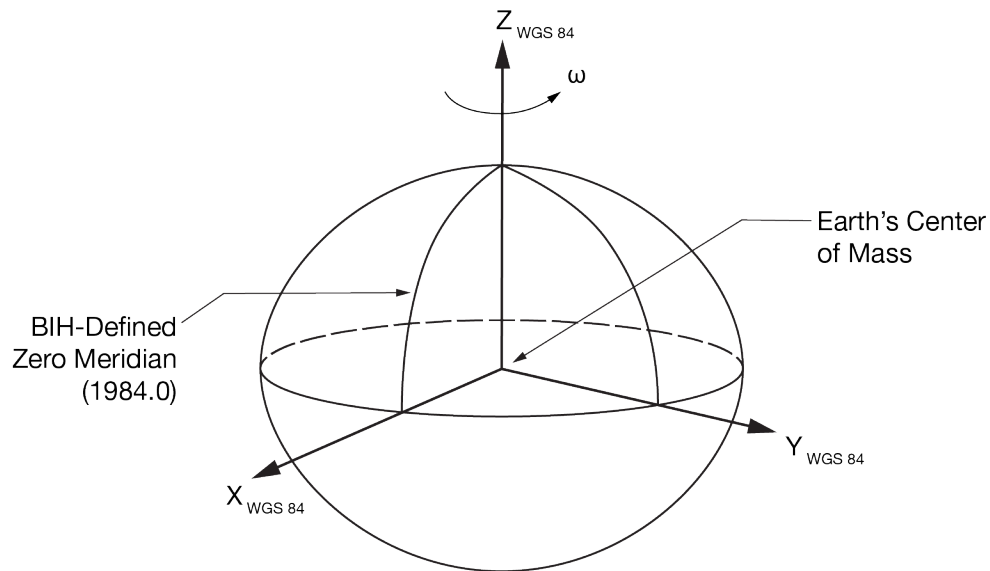
**Table 76: Definitions**

- Origin = Earth's center of mass
- Z-Axis = Parallel to the direction of the Conventional Terrestrial Pole (CTP) for polar motion, as defined by the Bureau International de l'Heure (BIH) on the basis of the coordinates adopted for the BIH stations.
- X-Axis = Intersection of the WGS 84 Reference Meridian Plane and the plane of the CTP's Equator, the Reference Meridian being parallel to the Zero Meridian defined by the BIH on the basis of the coordinates adopted for the BIH stations.
- Y-Axis = Completes a right-handed, earth-centered, earth-fixed (ECEF) orthogonal coordinate system, measured in the plane of the CTP Equator, 90° East of the X-Axis.



These definitions are analogous to the BIH Defined Conventional Terrestrial System (CTS), or BTS, 1984.0.

3.20 BSLNXYZ

RTK XYZ baseline

Platform: OEM719, OEM729, OEM7500, OEM7600, OEM7700, OEM7720, PwrPak7, SPAN CPT7, SMART7, SMART2

This log contains the receiver's RTK baseline in ECEF coordinates. The position status field indicates whether or not the corresponding data is valid. See *Figure 6: The WGS84 ECEF Coordinate System* on the previous page for a definition of the ECEF coordinates.

The BSLNXYZ log comes from time-matched base and rover observations such as in the **MATCHEDXYZ** log on page 528.



Asynchronous logs, such as BSLNXYZ, should only be logged ONCHANGED. Otherwise, the most current data is not output when it is available. This is especially true of the ONTIME trigger, which may cause inaccurate time tags to result.

Message ID: 686

Log Type: Asynch

Recommended Input:

```
log bslnxyza onchanged
```

ASCII Example:

```
#BSLNXYZA,COM1,0,59.5,FINESTEERING,1419,340033.000,02000040,5b48,2724;SOL_
COMPUTED,NARROW_INT,0.0012,0.0002,-
0.0004,0.0080,0.0160,0.0153,"AAAA",12,12,12,12,0,01,0,33*1a8a1b65
```

Field	Field type	Data Description	Format	Binary Bytes	Binary Offset
1	BSLNXYZ header	Log header. See <i>Messages</i> on page 27 for more information.		H	0
2	sol status	Solution status, see <i>Table 65: Solution Status</i> on page 374	Enum	4	H
3	bsln type	Baseline type, see <i>Table 66: Position or Velocity Type</i> on page 375	Enum	4	H+4
4	B-X	X Baseline (m)	Double	8	H+8
5	B-Y	Y Baseline (m)	Double	8	H+16
6	B-Z	Z Baseline (m)	Double	8	H+24
7	B-X σ	Standard deviation of B-X (m)	Float	4	H+32
8	B-Y σ	Standard deviation of B-Y (m)	Float	4	H+36
9	B-Z σ	Standard deviation of B-Z (m)	Float	4	H+40

Field	Field type	Data Description	Format	Binary Bytes	Binary Offset
10	stn ID	Base station identification	Char[4]	4	H+44
11	#SVs	Number of satellites tracked	Uchar	1	H+48
12	#solnSVs	Number of satellite vehicles used in solution	Uchar	1	H+49
13	#ggL1	Number of GPS plus GLONASS plus BDS L1/B1 used in solution	Uchar	1	H+50
14	#solnMultiSVs	Number of satellites with L1/E1/B1 signals used in solution	Uchar	1	H+51
15	Reserved		Uchar	1	H+52
16	ext sol stat	Extended solution status (see <i>Table 69: Extended Solution Status</i> on page 378)	Hex	1	H+53
17	Galileo and BeiDou sig mask	Galileo and BeiDou signals used mask (see <i>Table 68: Galileo and BeiDou Signal-Used Mask</i> on page 378)	Hex	1	H+54
18	GPS and GLONASS sig mask	GPS and GLONASS signals used mask (see <i>Table 67: GPS and GLONASS Signal-Used Mask</i> on page 377)	Hex	1	H+55
19	xxxx	32-bit CRC (ASCII and Binary only)	Hex	4	H+56
20	[CR][LF]	Sentence terminator (ASCII only)	-	-	-

3.21 CHANCONFIGLIST

Channel configuration list

Platform: OEM719, OEM729, OEM7500, OEM7600, OEM7700, OEM7720, PwrPak7, SPAN CPT7, SMART7, SMART2

This log provides the channel configuration list including the number of channels and signal types. If more than one channel configuration is available, then it can be switched using the **SELECTCHANCONFIG** command (see page 270).

Message ID: 1148

Log Type: Polled

Recommended Input:

```
log chanconfiglist once
```

Abbreviated ASCII Example:

```
<CHANCONFIGLIST COM1 0 73.0 FINESTEERING 2046 491998.494 02000008 d1c0 32768
5 5
7
16 GPSL1L2PL5
4 QZSSL1CAL2CL5
4 SBASL1
14 GLOL1L2
16 GALE1E5B
22 BEIDOUB1B2
5 LBAND
7
16 GPSL1L2
4 QZSSL1CAL2C
4 SBASL1
14 GLOL1L2
16 GALE1E5B
22 BEIDOUB1B2
5 LBAND
7
16 GPSL1L2PL2CL5
4 QZSSL1CAL2CL5
4 SBASL1
14 GLOL1L2PL2C
16 GALE1E5AE5BALTBOC
22 BEIDOUB1B2
5 LBAND
8
16 GPSL1L2PL2CL5
4 QZSSL1CAL2CL5
4 SBASL1L5
14 GLOL1L2PL2C
16 GALE1E5AE5BALTBOC
20 BEIDOUB1B1CB2B3
8 NAVICL5
5 LBAND
8
```

16 GPSL1L2PL2CL5L1C
 4 QZSSL1CAL2CL5L1CL6
 4 SBASL1L5
 14 GLOL1L2PL2CL3
 11 GALE1E5AE5BALTBOCE6
 16 BEIDOUB1B1CB2B3
 8 NAVICL5
 5 LBAND

Field	Field type	Description	Format	Binary Bytes	Binary Offset
1	CHANCONFIGLIST header	Log header. See <i>Messages</i> on page 27 for more information.		H	0
2	SetInUse	Current channel configuration being used. For example, if SetInUse is 2 then the second channel configuration listed in this log is the current channel configuration	Ulong	4	H
3	#chanconfigs	Number of channel configurations to follow	Ulong	4	H+4
4	#signaltypes	Total number of signal types in this channel configuration	Ulong	4	H+8
5	NumChans	Number of channels for individual signal type	Ulong	4	H+12
6	SignalType	See <i>Table 77: CHANCONFIGLIST Signal Type</i> below	Ulong	4	H+16
7	Next chanconfig offset = H + 8 + (#chanconfigs * (4 + (#signaltypes * 8)))				
8	xxxx	32-bit CRC (ASCII and Binary only)	Hex	4	variable
9	[CR][LF]	Sentence terminator (ASCII only)	-	-	-

Table 77: CHANCONFIGLIST Signal Type

Value	Name	Description
0	GPSL1	GPS L1 C/A
1	GPSL1L2	GPS L1 C/A and L2P(Y)
4	SBASL1	SBAS L1 C/A
5	GPSL5	GPS L5
6	GPSL1L2C	GPS L1 C/A and L2C
7	GPSL1L2AUTO	GPS L1 C/A and L2 P(Y) or L2C

Value	Name	Description
8	GLOL1L2	GLONASS L1 C/A and L2P
9	LBAND	L-Band
10	GLOL1	GLONASS L1 C/A
11	GALE1	Galileo E1
12	GALE5A	Galileo E5a
13	GALE5B	Galileo E5b
14	GALALTBOC	Galileo E5 AltBOC
15	BEIDOU1	BeiDou B1
16	GPSL1L2PL2C	GPS L1 C/A, L2 P(Y), and L2C
17	GPSL1L5	GPS L1 C/A and L5
18	SBASL1L5	SBAS L1 C/A and L5
19	GPSL1L2PL2CL5	GPS L1 C/A, L2 P(Y), L2C, and L5
20	GPSL1L2PL5	GPS L1 C/A, L2 P(Y), and L5
21	GALE1E5AE5B	Galileo E1, E5a, and E5b
22	GALE1E5AE5BALTBOC	Galileo E1, E5a, E5b, and E5 AltBOC
23	GALE1E5A	Galileo E1 and E5a
24	GLOL1L2C	GLONASS L1 C/A and L2C
25	GLOL1L2PL2C	GLONASS L1 C/A, L2 P, and L2C
26	QZSSL1CA	QZSS L1 C/A
27	QZSSL1CAL2C	QZSS L1 C/A and L2C
28	QZSSL1CAL2CL5	QZSS L1 C/A, L2C, and L5
29	QZSSL1CAL5	QZSS L1 C/A and L5
30	BEIDOU1B2	BeiDou B1 and B2I/B2a
31	GALE1E5B	Galileo E1 and E5b
32	BEIDOU1B3	BeiDou B1, B3
33	BEIDOU3	BeiDou B3
34	BEIDOU1B2B3	BeiDou B1, B2I/B2a and B3
35	GALE1E5AE5BALTBOCE6	Galileo E1, E5A, E5B, AltBOC, E6

Value	Name	Description
36	GPSL1L2PL2CL5L1C	GPS L1CA, L2P, L2C, L5, L1C
37	QZSSL1CAL2CL5L1C	QZSS L1CA, L2C, L5, L1C
38	QZSSL1CAL2CL5L1CL6	QZSS L1CA, L2C, L5, L1C, L6
39	GLOL1L3	GLONASS L1CA, L3
40	GLOL3	GLONASS L3
41	GLOL1L2PL2CL3	GLONASS L1CA, L2P, L2CA, L3
42	GPSL1L2PL2CL1C	GPS L1CA, L2P, L2C, L1C
43	QZSSL1CAL2CL1C	QZSS L1CA, L2C, L1C
44	NAVICL5	NavIC L5
45	BEIDOUB1C	BeiDou B1C
46	BEIDOUB1B1C	BeiDou B1I, B1C
47	BEIDOUB1B1CB2B3	BeiDou B1I, B1C, B2I/B2a, B3
48	BEIDOUB1B1CB2	BeiDou B1I, B1C, B2I/B2a



Configurations with BeiDou B2 will track either the B2I or B2a signal provided that the receiver RF supports both frequencies. Phase 2 BDS satellites transmit B2I but not B2a, while phase 3 satellites transmit B2a but not B2I.

3.22 CLOCKMODEL

Current clock model status

Platform: OEM719, OEM729, OEM7500, OEM7600, OEM7700, OEM7720, PwrPak7, SPAN CPT7, SMART7, SMART2

The CLOCKMODEL log contains a filtered representation of the receiver's clock bias relative to GPS system time.

Message ID: 16

Log Type: Synch

Recommended Input:

```
log clockmodela ontime 1
```

ASCII Example:

```
#CLOCKMODEL, USB1, 0, 76.5, FINESTEERING, 2032, 240222.000, 02000020, 98f9, 32768;
VALID, 0, 240222.000, 240222.000, -9.477561087e-02, -4.830560778e-02, 0.000000000,
4.862723266e-02, 1.117247043e-03, 0.000000000, 1.117247043e-03, 4.002808929e-03,
0.000000000, 0.000000000, 0.000000000, 0.000000000, -0.030, -5.532940561e-02, FALSE
*71e347cc
```



The CLOCKMODEL log can be used to monitor the clock drift of an internal oscillator once the CLOCKADJUST mode has been disabled. Watch the CLOCKMODEL log to see the drift rate and adjust the oscillator until the drift stops.

Field	Field type	Description	Format	Binary Bytes	Binary Offset
1	CLOCKMODEL header	Log header. See <i>Messages</i> on page 27 for more information.		H	0
2	status	Clock model status. See <i>Table 78: Clock Model Status</i> on the next page	Enum	4	H
3	reject_count	Number of rejected instantaneous clock errors	Ulong	4	H+4
4	propagation_time	Time of last propagation	GPSec	4	H+8
5	update_time	Time of last update	GPSec	4	H+12
6	bias	Receiver clock bias (m)	Double	8	H+16
7	rate	Receiver clock bias rate (m/s)	Double	8	H+24
8	Reserved		Double	8	H+32
9	bias_variance	Receiver clock bias variance (m ²)	Double	8	H+40

Field	Field type	Description	Format	Binary Bytes	Binary Offset
10	covariance	Receiver clock bias/bias rate covariance (m ² /s)	Double	8	H+48
11	Reserved		Double	8	H+56
12	Reserved		Double	8	H+64
13	rate_variance	Receiver clock bias rate variance (m ² /s ²)	Double	8	H+72
14	Reserved		Double	8	H+80
15	Reserved		Double	8	H+88
16	Reserved		Double	8	H+96
17	Reserved		Double	8	H+104
18	instantaneous_bias	Last instantaneous receiver clock bias (m)	Double	8	H+112
19	instantaneous_rate	Last instantaneous receiver clock bias rate (m/s)	Double	8	H+120
20	Reserved		Bool	4	H+128
21	xxxx	32-bit CRC (ASCII and Binary only)	Hex	4	H+132
22	[CR][LF]	Sentence terminator (ASCII only)	-	-	-

Table 78: Clock Model Status

Clock Status (Binary)	Clock Status (ASCII)	Description
0	VALID	The clock model is valid
1	CONVERGING	The clock model is near validity
2	ITERATING	The clock model is iterating towards validity
3	INVALID	The clock model is not valid

3.23 CLOCKSTEERING

Clock steering status

Platform: OEM719, OEM729, OEM7500, OEM7600, OEM7700, OEM7720, PwrPak7, SPAN CPT7, SMART7, SMART2

The CLOCKSTEERING log is used to monitor the current state of the clock steering process. All oscillators have some inherent drift. By default the receiver attempts to steer the receiver clock to accurately match GPS reference time.

Message ID: 26

Log Type: Asynch

Recommended Input:

```
log clocksteeringa onchanged
```

ASCII Example:

```
#CLOCKSTEERINGA,COM1,0,56.5,FINESTEERING,1337,394857.051,02000000,0f61,1984;
INTERNAL,SECOND_ORDER,4400,1707.554687500,0.029999999,-2.000000000,-0.224,
0.060*0e218bbc
```

Field	Field type	Description	Format	Binary Bytes	Binary Offset
1	CLOCKSTEERING header	Log header. See <i>Messages</i> on page 27 for more information.		H	0
2	source	Clock source, see <i>Table 79: Clock Source</i> on the next page	Enum	4	H
3	steering state	Steering state, see <i>Table 80: Steering State</i> on the next page	Enum	4	H+4
4	period	This value is set using the CLOCKCALIBRATE command (see page 92).	Ulong	4	H+8
5	pulse width	Current pulse width of the FREQUENCYOUT signal. The starting point for this value is set using the CLOCKCALIBRATE command (see page 92). The clock steering loop continuously adjusts this value in an attempt to drive the receiver clock offset and drift terms to zero.	Double	8	H+12
6	bandwidth	The current band width of the clock steering tracking loop in Hz. This value is set using the CLOCKCALIBRATE command (see page 92).	Double	8	H+20

Field	Field type	Description	Format	Binary Bytes	Binary Offset
7	slope	The current clock drift change in m/s/bit for a 1 LSB pulse width. This value is set using the CLOCKCALIBRATE command (see page 92).	Float	4	H+28
8	offset	The last valid receiver clock offset computed (m). It is the same as Field # 18 of the CLOCKMODEL log (see page 399).	Double	8	H+32
9	drift rate	The last valid receiver clock drift rate received (m/s). It is the same as Field # 19 of the CLOCKMODEL log (see page 399).	Double	8	H+40
10	xxxx	32-bit CRC (ASCII and Binary only)	Hex	4	H+48
11	[CR][LF]	Sentence terminator (ASCII only)	-	-	-

Table 79: Clock Source

Binary	ASCII	Description
0	INTERNAL	The receiver is currently steering its internal VCTCXO using an internal VARF signal
1	EXTERNAL	The receiver is currently steering an external oscillator using the external VARF signal

Table 80: Steering State

Binary	ASCII	Description
0	FIRST_ORDER	Upon start-up, the clock steering task adjusts the VARF pulse width to reduce the receiver clock drift rate to below 1 ms using a 1st order control loop. This is the normal start-up state of the clock steering loop.
1	SECOND_ORDER	Once the receiver has reduced the clock drift to below 1 m/s, it enters a second order control loop and attempts to reduce the receiver clock offset to zero. This is the normal runtime state of the clock steering process.
2	CALIBRATE_HIGH	This state corresponds to when the calibration process is measuring at the "High" pulse width setting. The CALIBRATE_HIGH state is only seen if you force the receiver to do a clock steering calibration using the CLOCKCALIBRATE command (see page 92). With the CLOCKCALIBRATE command (see page 92), you can force the receiver to calibrate the slope and center pulse width of the currently selected oscillator, to steer. The receiver measures the drift rate at several "High" and "Low" pulse width settings.

Binary	ASCII	Description
3	CALIBRATE_ LOW	<p>This state corresponds to when the calibration process is measuring at the "Low" pulse width setting.</p> <p>The CALIBRATE_LOW state is only seen if you force the receiver to do a clock steering calibration using the CLOCKCALIBRATE command (see page 92). With the CLOCKCALIBRATE command (see page 92), you can force the receiver to calibrate the slope and center pulse width of the currently selected oscillator, to steer. The receiver measures the drift rate at several "High" and "Low" pulse width settings.</p>
4	CALIBRATE_ CENTER	<p>This state corresponds to the "Center" calibration process. Once the center has been found, the modulus pulse width, center pulse width, loop bandwidth and measured slope values are saved in NVM and are used from now on for the currently selected oscillator (INTERNAL or EXTERNAL).</p> <p>After the receiver has measured the "High" and "Low" pulse width setting, the calibration process enters a "Center calibration" process where it attempts to find the pulse width required to zero the clock drift rate.</p>

3.24 DATUMTRANSFORMATIONS

Available datum transformations

Platform: OEM719, OEM729, OEM7500, OEM7600, OEM7700, OEM7720, PwrPak7, SPAN CPT7, SMART7, SMART2

This log reports the datum transformations known to the receiver. This includes the default transformations included in the firmware, plus user-defined transformations entered using the **DATUMTRANSFORMATION** command (see page 102).

The entry "USER" to "WGS84" transformation in this log is the datum transformation set by the **USERDATUM** command (see page 325) or the **USEREXPDATUM** command (see page 327). The parameters in this entry will differ from those entered via the user datum commands due to differences in units and convention.

Message ID: 2298

Log Type: Asynch

Recommended Input:

```
log datumtransformations
```

Abbreviated ASCII Example:

```
<DATUMTRANSFORMATIONS COM1 0 75.5 UNKNOWN 0 0.799 02440020 f957 32768
< 10
< "ITRF2014" "ITRF2005" 2010.000 0.0026 0.0010 -0.0023 0.0
< "ITRF2014" "ITRF2008" 2010.000 0.0016 0.0019 0.0024 0.00
< "ITRF2014" "ETRF2000" 2010.000 0.0547 0.0522 -0.0741 1.7
< "ITRF2014" "ETRF2005" 1989.000 0.0523 0.0490 -0.0372 0.0
< "ITRF2014" "ETRF2014" 2010.000 0.0000 0.0000 0.0000 1.78
< "ITRF2014" "NAD83 (NSRS2011)" 1997.000 0.9950 -1.9014 -0
< "ITRF2014" "NAD83 (CSRS)" 1997.000 0.9950 -1.9014 -0.5228
< "ITRF2014" "GDA94" 1994.000 -0.0831 -0.0175 0.0360 0.425
< "ITRF2014" "GDA2020" 2020.000 0.0000 0.0000 0.0000 0.000
< "USER" "WGS84" 0.000 0.0000 0.0000 0.0000 0.0000 0.0000
```

Field	Field Type	Description	Format	Binary Bytes	Binary Offset
1	DATUMTRANSFORMATIONS header	Log header. See <i>Messages</i> on page 27 for more information.	-	H	0
2	# transformations	Number of transformations to follow	Ulong	4	H
3	from	Name of from datum	Char [32]	variable	H+4
4	to	Name of to datum	Char [32]	variable	variable

Field	Field Type	Description	Format	Binary Bytes	Binary Offset
5	epoch	Reference epoch of parameters (decimal year) Examples: 2011.00 = Jan 1, 2011, 2011.19 = Mar 11, 2011	Double	8	variable
6	tx	Translations at reference epoch (meters)	Float	4	variable
7	ty		Float	4	variable
8	tz		Float	4	variable
9	rx	Rotations at reference epoch (milliarcseconds)	Float	4	variable
10	ry		Float	4	variable
11	rz		Float	4	variable
12	scale	Scale difference at reference epoch (parts per billion)	Float	4	variable
13	tx_vel	Translation rates (meters/year)	Float	4	variable
14	ty_vel		Float	4	variable
15	tz_vel		Float	4	variable
16	rx_vel	Rotation rates (milliarcseconds/year)	Float	4	variable
17	ry_vel		Float	4	variable
18	rz_vel		Float	4	variable
19	scale_vel	Scale difference rate (parts per billion/year)	Float	4	variable
21...	Next transformation offset = variable				
variable	xxxx	32-bit CRC (ASCII and Binary only)	Ulong	4	variable
variable	[CR][LF]	Sentence terminator (ASCII only)	-	-	-

3.25 ETHSTATUS

Current Ethernet status

Platform: OEM729, OEM7600, OEM7700, OEM7720, PwrPak7, SPAN CPT7, SMART7-I, SMART7-SI

This log provides the current status of the Ethernet ports.

Message ID: 1288

Log Type: Polled

Recommended Input:

```
log ethstatusa once
```

ASCII Example:

```
#ETHSTATUSA,COM1,0,89.5,FINESTEERING,1609,500138.174,02000000,e89d,6259;1,ETHA,
"00-21-66-00-05-A2",100_FULL*98d86b04
```

Field	Field Type	Description	Format	Binary Bytes	Binary Offset
1	ETHSTATUS header	Log header. See <i>Messages</i> on page 27 for more information.	-	H	0
2	#of interfaces	Number of records to follow	Ulong	4	H
3	interface	Name of the Ethernet interface (e.g., ETHA)	Enum	4	H+4
4	MAC address	An identifier assigned to the network adapters or network interface card	String [18]	variable 1	H+8
5	interface configuration	Current connectivity, speed and duplex settings of the Ethernet interface	Enum	4	H+26
6...	Next interface = H+4+(# of interfaces * 26)				
7	xxxx	32-bit CRC (ASCII and Binary only)	Hex	4	H+4+(# of interfaces * 26)
8	[CR][LF]	Sentence terminator (ASCII only)	-	-	-



Refer to the **ETHCONFIG** command (see page 117) for enum values.

¹In the binary case, each string field needs to be NULL terminated and additional bytes of padding added to maintain 4-byte alignment, up to the maximum defined by the string size. The next defined field starts immediately at the next 4-byte alignment following the NULL.

3.26 GALALMANAC

Decoded Galileo Almanac

Platform: OEM719, OEM729, OEM7500, OEM7600, OEM7700, OEM7720, PwrPak7, SPAN CPT7, SMART7, SMART2

This log contains the decoded Galileo almanac parameters from Galileo navigation messages. Multiple messages are transmitted, one for each satellite ID with data. The Galileo almanac can come from any of the E1, E5a or E5b signals.

The OEM7 family of receivers automatically save almanacs in their Non-Volatile Memory (NVM), so creating an almanac boot file is not necessary.

Message ID: 1120

Log Type: Asynch

Recommended Input:

```
log galalmanaca onchanged
```

ASCII Example:

```
#GALALMANACA, COM1, 3, 83.5, SATTIME, 1769, 333371.000, 02000020, 131f, 45362;
19, FALSE, TRUE, 0, 0, 0, 0, 10, 745, 332400.000, 1.221e-04, -5.486e-09,
2.757e+00, 2.038e+00, -1.226e+00, -1.1444e-05, 0.000, 2.539e-02, -1.457e-02
*5c77f44b
```

```
#GALALMANACA, COM1, 2, 83.5, SATTIME, 1769, 333399.000, 02000020, 131f, 45362;
20, FALSE, TRUE, 0, 0, 0, 0, 10, 745, 332400.000, 1.831e-04, -5.486e-09,
2.757e+00, 1.542e+00, -3.1734e-02, 4.8084e-03, 9.495e-10, 2.539e-02,
-1.457e-02*3530e391
```

```
#GALALMANACA, COM1, 1, 83.5, SATTIME, 1769, 333939.000, 02000020, 131f, 45362;
11, FALSE, TRUE, 0, 0, 0, 0, 11, 745, 333000.000, 6.104e-05, -5.120e-09,
6.6412e-01, 2.396e+00, -1.032e+00, 5.1498e-05, 1.091e-11, 3.125e-02,
-1.764e-02*afa0f631
```

```
#GALALMANACA, COM1, 0, 83.5, SATTIME, 1769, 333941.000, 02000020, 131f, 45362;
12, FALSE, TRUE, 0, 0, 0, 0, 11, 745, 333000.000, 1.526e-04, -5.120e-09,
6.6412e-01, -2.392e+00, -1.818e+00, 6.4850e-05, 1.091e-11, 3.516e-02,
-1.764e-02*ef41e1b2
```



The speed at which the receiver locates and locks onto new satellites is improved if the receiver has approximate time and position (**SETAPPROXTIME** and **SETAPPROXPOS**), as well as an almanac. This allows the receiver to compute the elevation of each satellite so it can tell which satellites are visible and their Doppler offsets, improving Time to First Fix (TTFF).

Field	Field Type	Description	Format	Binary Bytes	Binary Offset
1	GALALMANAC header	Log header. See <i>Messages</i> on page 27 for more information.		H	0
2	SatId	Satellite ID	Ulong	4	H
3	FNAVReceived	Indicates F/NAV almanac data received	Bool	4	H+4
4	INAVReceived	Indicates I/NAV almanac data received	Bool	4	H+8
5	E1BHealth	E1B health status bits (only valid if INAVReceived is TRUE)	Uchar	1	H+12
6	E5aHealth	E5a health status bits (only valid if FNAVReceived is TRUE)	Uchar	1	H+13
7	E5bHealth	E5b health status bits (only valid if INAVReceived is TRUE)	Uchar	1	H+14
8	Reserved		Uchar	1	H+15
9	IODa	Almanac issue of data	Ulong	4	H+16
10	Weeks	Almanac reference week since the Galileo system time start epoch (August 22nd 1999)	Ulong	4	H+20
11	Seconds	Almanac reference time of week (s for ASCII, ms for binary)	GPsec	4	H+24
12	Ecc	Eccentricity (dimensionless)	Double	8	H+28
13	OmegaDot	Rate of right ascension (radians/s)	Double	8	H+36
14	Omega0	Right ascension (radians)	Double	8	H+44
15	Omega	Argument of perigee (radians)	Double	8	H+52
16	M0	Mean anomaly at ref time (radians)	Double	8	H+60
17	Af0	Satellite clock correction bias (s)	Double	8	H+68
18	Af1	Satellite clock correction linear (s/s)	Double	8	H+76
19	DeltaRootA	Difference with respect to the square root of the nominal semi-major axis (sqrt(m))	Double	8	H+84
20	DeltaI	Inclination at reference time relative to IO = 56 degrees	Double	8	H+92
21	xxxx	32-bit CRC (ASCII and Binary only)	Hex	4	H+100
22	[CR][LF]	Sentence terminator (ASCII only)	-	-	-

3.27 GALCLOCK

Galileo clock information

Platform: OEM719, OEM729, OEM7500, OEM7600, OEM7700, OEM7720, PwrPak7, SPAN CPT7, SMART7, SMART2

This log contains the Galileo time information.



This log is populated from both the I/NAV and F/NAV messages from any of the E1, E5a or E5b signals. Depending on the data source, it is possible that the time in the header of the log is earlier than the time in a previous log. This is expected behavior.

Message ID: 1121

Log Type: Asynch

Recommended Input:

```
log galclocka onchanged
```

ASCII Example:

```
#GALCLOCKA, COM1, 0, 84.5, SATTIME, 1769, 336845.000, 02000020, c6cf, 45362;  
8.381903172e-09, -3.5527137e-15, 16, 259200, 233, 28, 7, 16, -3.5216e-09,  
-1.776e-14, 345600, 41*186e9085
```

Field	Field Type	Description	Format	Binary Bytes	Binary Offset
1	GALCLOCK header	Log header. See <i>Messages</i> on page 27 for more information.		H	0
2	A0	Constant term of polynomial (s)	Double	8	H
3	A1	1st order term of polynomial (s/s)	Double	8	H+8
4	DeltaTls	Leap second count before leap second adjustment	Long	4	H+16
5	Tot	UTC data reference time of week (s)	Ulong	4	H+20
6	WNt	UTC data reference week number	Ulong	4	H+24
7	WNlsf	Week number of leap second adjustment	Ulong	4	H+28
8	DN	Day number at the end of which a leap second adjustment becomes effective	Ulong	4	H+32
9	DeltaTlsf	Leap second count after leap second adjustment	Long	4	H+36
10	A0g	Constant term of the polynomial describing the difference between Galileo and GPS time (s)	Double	8	H+40

Field	Field Type	Description	Format	Binary Bytes	Binary Offset
11	A1g	Rate of change of offset the offset between Galileo and GPS time (s/s)	Double	8	H+48
12	T0g	Reference time for GGTO data (s)	Ulong	4	H+56
13	WN0g	Week number of GGTO reference	Ulong	4	H+60
14	xxxx	32-bit CRC (ASCII and Binary only)	Hex	4	H+64
15	[CR][LF]	Sentence terminator (ASCII only)	-	-	-

3.28 GALCNAVRAWPAGE

Galileo raw CNAV page

Platform: OEM719, OEM729, OEM7500, OEM7700, OEM7720, PwrPak7, SPAN CPT7, SMART7, SMART7-I, SMART7-S, SMART7-SI, SMART7-W

This log provides Galileo raw C/NAV page data from Galileo E6 signals.

Message ID: 2239

Log Type: Asynch

Recommended Input:

```
log galcnavrwapage onnew
```

Abbreviated ASCII Example:

```
<GALCNAVRAWPAGE USB1 0 49.5 SATTIME 1997 145162.000 02040020 ab53 32768
< 319 30 2761
2b26bcef0c04f6711bf86137086a12c14f87c07b4c6aa4de04bceb8612c34c691bfabceceb86bce
d4f851bfb0c074c68613604bff48448d33487
```

Field	Field Type	Description	Format	Binary Bytes	Binary Offset
1	GALCNAVRAWPAGE header	Log header. See <i>Messages</i> on page 27 for more information.	-	H	0
2	signal channel	Signal channel providing the bits	Ulong	4	H
3	PRN	Satellite PRN number	Ulong	4	H+4
4	Page ID	The page ID	Ulong	4	H+8
5	data	Raw CNAV page data	HEX [58]	58	H+12
6	xxxx	32-bit CRC (ASCII and Binary only)	Hex	4	h+70
7	[CR][LF]	Sentence terminator (ASCII only)	-	-	-

3.29 GALFNAVEPHEMERIS

Decoded Galileo FNAV Ephemeris

Platform: OEM719, OEM729, OEM7500, OEM7600, OEM7700, OEM7720, PwrPak7, SPAN CPT7, SMART7, SMART2

The GALFNAVEPHEMERIS log contains the Galileo F/NAV ephemeris information. Multiple messages are transmitted, one for each satellite ID. The F/NAV messages are only transmitted on E5a.

Message ID: 1310

Log Type: Asynch

Recommended Input:

```
log galfnavephemerisa onchanged
```

ASCII Example:

```
#GALFNAVEPHEMERISA,COM2,0,82.5,SATTIME,1874,148850.000,02400000,02cd,
32768;22,0,0,0,0,118,122,0,147600,147600,-6.101167919e-01,3.1687e-09,
4.478077171e-04,5.44059147e+03,9.639218456e-01,6.4610e-10,
2.329679501e-01,2.55827293e+00,-5.5577315e-09,1.0207e-06,8.2552e-06,
1.611e+02,2.313e+01,4.0978e-08,-1.8626e-09,1.335504232e-03,
1.768257e-10,0.0,2.561e-09*d02e28ca
```

Field	Field Type	Description	Format	Binary Bytes	Binary Offset
1	GALFNAV EPHEMERIS header	Log header. See <i>Messages</i> on page 27 for more information.		H	0
2	SatId	Satellite identifier	Ulong	4	H
3	E5aHealth	E5a health status bits	Uchar	1	H+4
4	E5aDVS	E5a data validity status	Uchar	1	H+5
5	Reserved		Uchar	1	H+6
6	Reserved		Uchar	1	H+7
7	IODnav	Issue of data ephemeris	Ushort	2	H+8
8	SISA Index	Signal in space accuracy (unitless)	Uchar	1	H+10
9	Reserved		Uchar	1	H+11
10	T0e	Ephemeris reference time (s)	Ulong	4	H+12
11	T0c	Clock correction data reference time of week from the F/NAV message (s)	Ulong	4	H+16
12	M0	Mean anomaly at ref time (radians)	Double	8	H+20

Field	Field Type	Description	Format	Binary Bytes	Binary Offset
13	DeltaN	Mean motion difference (radians/s)	Double	8	H+28
14	Ecc	Eccentricity (unitless)	Double	8	H+36
15	RootA	Square root of semi-major axis	Double	8	H+44
16	I0	Inclination angle at ref time (radians)	Double	8	H+52
17	IDot	Rate of inclination angle (radians/s)	Double	8	H+60
18	Omega0	Longitude of ascending node of orbital plane at weekly epoch (radians)	Double	8	H+68
19	Omega	Argument of perigee (radians)	Double	8	H+76
20	OmegaDot	Rate of right ascension (radians/s)	Double	8	H+84
21	Cuc	Amplitude of the cosine harmonic correction term to the argument of latitude (radians)	Double	8	H+92
22	Cus	Amplitude of the sine harmonic correction term to the argument of latitude (radians)	Double	8	H+100
23	Crc	Amplitude of the cosine harmonic correction term to the orbit radius (m)	Double	8	H+108
24	Crs	Amplitude of the sine harmonic correction term to the orbit radius (m)	Double	8	H+116
25	Cic	Amplitude of the cosine harmonic correction term to the angle of inclination (radians)	Double	8	H+124
26	Cis	Amplitude of the sine harmonic correction term to the angle of inclination (radians)	Double	8	H+132
27	Af0	SV clock bias correction coefficient from the F/NAV message (s)	Double	8	H+140
28	Af1	SV clock drift correction coefficient from the F/NAV message (s/s)	Double	8	H+148
29	Af2	SV clock drift rate correction coefficient from the F/NAV message (s/s ²)	Double	8	H+156
30	E1E5aBGD	E1, E5a broadcast group delay	Double	8	H+164
31	xxxx	32-bit CRC (ASCII and Binary only)	Hex	4	H+172
32	[CR][LF]	Sentence terminator (ASCII only)	-	-	-

3.30 GALFNAVRAWPAGE

Raw Galileo FNAV page data

Platform: OEM719, OEM729, OEM7500, OEM7600, OEM7700, OEM7720, PwrPak7, SPAN CPT7, SMART7, SMART2

This log contains the raw Galileo F/NAV page data. The F/NAV messages are only transmitted on E5a.

Log Type: Asynch

Recommended Input:

```
log galfnavrpagea onchanged
```

ASCII Example:

```
#GALFNAVRAWPAGEA,USB3,0,85.0,SATTIME,1680,434410.000,02000008,d4fb,43274;56,11,0b818df50ad5ffc151001baffdaa04d5dae655e17affc8a41a83aa*5955b14d
```

Field	Field Type	Description	Format	Binary Bytes	Binary Offset
1	GALFNAVRAWPAGE header	Log header. See <i>Messages</i> on page 27 for more information.		H	0
2	signal channel	Signal channel providing the data	Ulong	4	H
3	SVID	SVID of transmitting satellite	Ulong	4	H+4
4	raw frame data	Raw F/NAV page (214 bits). Does not include CRC or Tail bits.	Hex[27]	27	H+8
5	xxxx	32-bit CRC (ASCII and Binary only)	Hex	4	H+35
6	[CR][LF]	Sentence terminator (ASCII only)	-	-	-

3.31 GALINAVEPHEMERIS

Decoded Galileo INAV Ephemeris

Platform: OEM719, OEM729, OEM7500, OEM7600, OEM7700, OEM7720, PwrPak7, SPAN CPT7, SMART7, SMART2

The GALINAVEPHEMERIS log contains the Galileo I/NAV ephemeris information. Multiple messages are transmitted, one for each SVID with date. The I/NAV messages are only transmitted on E1 and E5b.

Message ID: 1309

Log Type: Asynch

Recommended Input:

```
log galinavephemerisa onchanged
```

ASCII Example:

```
#GALINAVEPHEMERISA, COM1, 10, 82.0, SATTIME, 1930, 494134.000, 02000020, dbe9,
32768;1,0,0,0,0,0,0,0,0,54,107,1,493200,493200,2.98962614e+00,
2.7990e-09,1.763084438e-04,5.44061901e+03,9.996620695e-01,-2.8608e-10,
-2.52251354e+00,-1.37786826e+00,-5.7041662e-09,-3.7253e-09,3.8184e-06,
2.773e+02,4.6875e-01,-7.0781e-08,4.6566e-08,3.960891627e-05,
-9.904966e-12,0.0,-6.752e-09,-7.683e-09*b575a8b9

#GALINAVEPHEMERISA, COM1, 9, 82.0, SATTIME, 1930, 511405.000, 02000020, dbe9,
32768;2,0,0,0,0,0,0,0,0,81,107,3,509400,509400,1.23345967e+00,
2.9637e-09,2.852674806e-04,5.44061650e+03,9.996659901e-01,-2.3537e-10,
-2.52264339e+00,-7.551901559e-01,-5.8113135e-09,5.2713e-07,2.4810e-06,
3.021e+02,1.034e+01,-1.3039e-08,1.8626e-09,-2.745073289e-07,
1.705303e-13,0.0,-8.149e-09,-9.546e-09*6df98c07

#GALINAVEPHEMERISA, COM1, 8, 82.0, SATTIME, 1930, 511384.000, 02000020, dbe9,
32768;8,0,0,0,0,0,0,0,0,83,107,3,510600,510600,1.19121266e+00,
3.0755e-09,1.157049555e-04,5.44062434e+03,9.581430032e-01,-2.9858e-10,
1.66547803e+00,7.075104782e-01,-5.5223729e-09,-1.5851e-06,1.2502e-05,
6.706e+01,-3.447e+01,5.5879e-09,-5.7742e-08,4.641003208e-03,
3.982876e-10,0.0,-1.048e-08,-1.211e-08*99c692a8

...

#GALINAVEPHEMERISA, COM1, 1, 82.0, SATTIME, 1930, 511405.000, 02000020, dbe9,
32768;26,0,0,0,0,0,0,0,0,83,107,1,510600,510600,-1.25500637e+00,2.9951
e-09,2.602027962e-04,5.44060480e+03,9.688215634e-01,3.7894e-10,-4.2237
68063e-01,-2.61686286e+00,-5.6309488e-09,-4.0233e-07,8.1658e-06,1.711e
+02,-8.500e+00,-1.3039e-08,-3.1665e-08,5.767530005e-03,4.148148e-10,
0.0,-6.985e-10,-9.313e-10*0e6670f3

#GALINAVEPHEMERISA, COM1, 0, 82.0, SATTIME, 1930, 511405.000, 02000020, dbe9,
32768;30,0,0,0,0,0,0,0,0,83,107,1,510600,510600,-2.836817871e-01,
2.9558e-09,2.358634956e-04,5.44061465e+03,9.972253278e-01,-1.9894e-10,
-2.51793093e+00,1.101770916e-01,-5.7991701e-09,7.0594e-07,2.4680e-06,
3.045e+02,1.675e+01,-1.8626e-08,5.0291e-08,4.957979254e-03,
3.988703e-10,0.0,-4.889e-09,-5.821e-09*4513b897
```

Field	Field Type	Description	Format	Binary Bytes	Binary Offset
1	GALINAV EPHEMERIS header	Log Header		H	0
2	SatId	Satellite identifier	Ulong	4	H
3	E5bHealth	E5b health status bits	Uchar	1	H+4
4	E5bDVS	E5b data validity status	Uchar	1	H+5
5	Reserved		Uchar	1	H+6
6	Reserved		Uchar	1	H+7
7	E1bHealth	E1b health status bits	Uchar	1	H+8
8	E1bDVS	E1b data validity status	Uchar	1	H+9
9	Reserved		Uchar	1	H+10
10	Reserved		Uchar	1	H+11
11	IODnav	Issue of data ephemeris	Ushort	2	H+12
12	SISA Index	Signal in space accuracy (unitless)	Uchar	1	H+14
13	INAV Source	Identifies the source signal: 0 = Unknown 1 = E1b 2 = E5b 3 = E1b and E5b	Uchar	1	H+15
14	T0e	Ephemeris reference time (s)	Ulong	4	H+16
15	T0c	Clock correction data reference time of week from the I/NAV message (s)	Ulong	4	H+20
16	M0	Mean anomaly at ref time (radians)	Double	8	H+24
17	DeltaN	Mean motion difference (radians/s)	Double	8	H+32
18	Ecc	Eccentricity (unitless)	Double	8	H+40
19	RootA	Square root of semi-major axis	Double	8	H+48
20	I0	Inclination angle at ref time (radians)	Double	8	H+56
21	IDot	Rate of inclination angle (radians/s)	Double	8	H+64
22	Omega0	Longitude of ascending node of orbital plane at weekly epoch (radians)	Double	8	H+72

Field	Field Type	Description	Format	Binary Bytes	Binary Offset
23	Omega	Argument of perigee (radians)	Double	8	H+80
24	OmegaDot	Rate of right ascension (radians/s)	Double	8	H+88
25	Cuc	Amplitude of the cosine harmonic correction term to the argument of latitude (radians)	Double	8	H+96
26	Cus	Amplitude of the sine harmonic correction term to the argument of latitude (radians)	Double	8	H+104
27	Crc	Amplitude of the cosine harmonic correction term to the orbit radius (m)	Double	8	H+112
28	Crs	Amplitude of the sine harmonic correction term to the orbit radius (m)	Double	8	H+120
29	Cic	Amplitude of the cosine harmonic correction term to the angle of inclination (radians)	Double	8	H+128
30	Cis	Amplitude of the sine harmonic correction term to the angle of inclination (radians)	Double	8	H+136
31	Af0	SV clock bias correction coefficient from the I/NAV message (s)	Double	8	H+144
32	Af1	SV clock drift correction coefficient from the I/NAV message (s/s)	Double	8	H+152
33	Af2	SV clock drift rate correction coefficient from the I/NAV message (s/s ²)	Double	8	H+160
34	E1E5aBGD	E1, E5a broadcast group delay	Double	8	H+168
35	E1E5bBGD	E1, E5b broadcast group delay	Double	8	H+176
36	xxxx	32-bit CRC (ASCII and Binary only)	Hex	4	H+184
37	[CR][LF]	Sentence terminator (ASCII only)	-	-	-

3.32 GALINAVRAWWORD

Raw Galileo INAV word data

Platform: OEM719, OEM729, OEM7500, OEM7600, OEM7700, OEM7720, PwrPak7, SPAN CPT7, SMART7, SMART2

This log contains the raw Galileo I/NAV word data. The I/NAV messages are only transmitted on E1 and E5b.

Message ID: 1414

Log Type: Asynch

Recommended Input:

```
log galinavrawworda onchanged
```

ASCII Example:

```
#GALINAVRAWWORDA,USB3,0,84.5,SATTIME,1680,434401.000,02000008,884b,43274;55,11,GALE1,0b81e655e17a26eb5237d7d20088ffc9*dcb4bedb
```

Field	Field Type	Description	Format	Binary Bytes	Binary Offset
1	GALINAVRAWWORD header	Log header. See <i>Messages</i> on page 27 for more information.		H	0
2	signal channel	Signal channel providing data	Ulong	4	H
3	SVID	Space Vehicle ID (SVID) of transmitting satellite	Ulong	4	H+4
4	signal type	Signal Type as defined in <i>Table 81: Signal Type</i> below	Enum	4	H+8
5	raw frame data	Raw I/NAV word (128 bits)	Hex[16]	16	H+12
6	xxxx	32-bit CRC (ASCII and binary only)	Hex	4	H+28
7	[CR][LF]	Sentence terminator (ASCII only)	-	-	-

Table 81: Signal Type

Value (Binary)	Signal (ASCII)	Description
33	GPSL1CA	GPS L1 C/A-code
47	GPSL1CP	GPS L1C P-code
68	GPSL2Y	GPS L2 P(Y)-code
69	GPSL2C	GPS L2 C/A-code
70	GPSL2P	GPS L2 P-code

Value (Binary)	Signal (ASCII)	Description
103	GPSL5	GPS L5
2177	GLOL1CA	GLONASS L1 C/A-code
2211	GLOL2CA	GLONASS L2 C/A-code
2212	GLOL2P	GLONASS L2 P-code
2662	GLOL3	GLONASS L3
4129	SBASL1	SBAS L1
4194	SBASL5	SBAS L5
10433	GALE1	Galileo E1
10466	GALE5A	Galileo E5A
10499	GALE5B	Galileo E5B
10532	GALALTBOC	Galileo ALT-BOC
10565	GALE6C	Galileo E6C
10572	GALE6B	Galileo E6B
12673	BDSB1D1	BeiDou B1 with D1 navigation data
12674	BDSB1D2	BeiDou B1 with D2 navigation data
12803	BDSB2D1	BeiDou B2 with D1 navigation data
12804	BDSB2D2	BeiDou B2 with D2 navigation data
12877	BDSB3D1	BeiDou B3 with D1 navigation data
12880	BDSB3D2	BeiDou B3 with D2 navigation data
12979	BDSB1C	BeiDou B1C
13012	BDSB2A	BeiDou B2a
14753	QZSSL1CA	QZSS L1 C/A-code
14760	QZSSL1CP	QZSS L1C P-code
14787	QZSSL2CM	QZSS L2 C/A-code
14820	QZSSL5	QZSS L5
14891	QZSSL6P	QZSS L6P
19073	NAVICL5SPS	NavIC L5 SPS

3.33 GALIONO

Decoded Galileo ionospheric corrections

Platform: OEM719, OEM729, OEM7500, OEM7600, OEM7700, OEM7720, PwrPak7, SPAN CPT7, SMART7, SMART2

This log contains the decoded Galileo ionospheric corrections.

Message ID: 1127

Log Type: Asynch

Recommended Input:

```
log galionoa onchanged
```

ASCII Example:

```
#GALIONOA,COM1,0,81.5,SATTIME,1930,512134.000,02000020,d22e,32768;  
6.03e+01,-2.344e-02,-3.9368e-03,0,0,0,0,0*f50fae69
```

Field	Field Type	Description	Format	Binary Bytes	Binary Offset
1	GALIONO header	Log header. See <i>Messages</i> on page 27 for more information.		H	0
2	Ai0	Effective ionization level 1st order parameter (sfu)	Double	8	H
3	Ai1	Effective ionization level 2st order parameter (sfu/degree)	Double	8	H+8
4	Ai2	Effective ionization level 3st order parameter (sfu/degree ²)	Double	8	H+16
5	SF1	Ionospheric disturbance flag for region 1	Uchar	1	H+24
6	SF2	Ionospheric disturbance flag for region 2	Uchar	1	H+25
7	SF3	Ionospheric disturbance flag for region 3	Uchar	1	H+26
8	SF4	Ionospheric disturbance for flag region 4	Uchar	1	H+27
9	SF5	Ionospheric disturbance for flag region 5	Uchar	1	H+28
10	xxxx	32-bit CRC (ASCII and Binary only)	Hex	4	H+29
11	[CR][LF]	Sentence terminator (ASCII only)	-	-	-

3.34 GEODETICDATUMS

Available datums

Platform: OEM719, OEM729, OEM7500, OEM7600, OEM7700, OEM7720, PwrPak7, SPAN CPT7, SMART7, SMART2

This log shows a list of available datums. User-defined datums can be added using the **GEODETICDATUM** command (see page 137).

The "USER" entry in the this log is the datum set by the **USERDATUM** command (see page 325) or the **USEREXPDATUM** command (see page 327).

Message ID: 2296

Log Type: Asynch

Recommended Input:

```
log geodeticdatums
```

Abbreviated ASCII Example:

```
<GEODETICDATUMS COM1 0 75.0 UNKNOWN 0 1.591 02000020 e7f2 15427
< 12
< "WGS84" 6326 EARTH_FIXED 6378137.00 298.2572235630
< "ITRF2005" 6896 EARTH_FIXED 6378137.00 298.2572221010
< "ITRF2008" 1061 EARTH_FIXED 6378137.00 298.2572221010
< "ITRF2014" 1165 EARTH_FIXED 6378137.00 298.2572221010
< "ETRF2000" 1186 PLATE_FIXED 6378137.00 298.2572221010
< "ETRF2005" 1204 PLATE_FIXED 6378137.00 298.2572221010
< "ETRF2014" 1206 PLATE_FIXED 6378137.00 298.2572221010
< "NAD83(NSRS2011)" 1116 PLATE_FIXED 6378137.00 298.2572221010
< "NAD83(CSRS)" 6140 PLATE_FIXED 6378137.00 298.2572221010
< "GDA94" 6283 PLATE_FIXED 6378137.00 298.2572221010
< "GDA2020" 1168 PLATE_FIXED 6378137.00 298.2572221010
< "USER" 0 UNKNOWN 6378137.00 298.2572235628
```

Field	Field Type	Description	Format	Binary Bytes	Binary Offset
1	GEODETICDATUMS header	Log header. See <i>Messages</i> on page 27 for more information.	-	H	0
2	# datums	Number of datums to follow	Ulong	4	H
3	name	Name of datum	Char [32]	variable	H+4

Field	Field Type	Description	Format	Binary Bytes	Binary Offset
4	epsg_code	EPSG code of datum	Ulong	4	variable
5	anchor	The datum's anchor. See <i>Table 29: Datum Anchors</i> on page 138.	Enum	4	variable
6	semimajor_axis	Semi-major axis of datum's ellipsoid (m)	Double	8	variable
7	flattening	Inverse flattening of datum's ellipsoid (unitless)	Double	8	variable
8...	Next datum offset = variable				
variable	xxxx	32-bit CRC (ASCII and Binary only)	Ulong	4	variable
variable	[CR][LF]	Sentence terminator (ASCII only)	-	-	-

3.35 GLMLA

NMEA GLONASS Almanac data

Platform: OEM719, OEM729, OEM7500, OEM7600, OEM7700, OEM7720, PwrPak7, SPAN CPT7, SMART7, SMART2

This log outputs almanac data for GLONASS satellites. Multiple sentences are transmitted, one for each satellite.



The following relationships enable translation between the NMEA GLONASS satellite IDs, the NovAtel GLONASS PRN IDs, and the GLONASS slot numbers:

NMEA GLONASS satellite ID	= GLONASS slot number + 64
NovAtel GLONASS PRN ID	= GLONASS slot number + 37
	= NMEA GLONASS satellite ID - 27

Message ID: 859

Log Type: Asynch

Recommended Input:

```
log glmlaa onchanged
```

ASCII Example:

```
$GLMLA,16,01,65,1176,07,0496,4c,5ff2,8000,34c05e,0e93e8,04b029,001fa2,099,213*6
8
$GLMLA,16,02,66,1176,01,12e3,4c,42cc,8000,34c08e,10fae9,02f48c,00224e,099,003*6
4
$GLMLA,16,03,67,1176,8c,08f6,4a,ef4d,8000,34c051,13897b,00d063,001b09,099,000*6
3
$GLMLA,16,04,68,1176,06,116b,48,3a00,8000,34c09d,02151f,0e49e8,00226e,099,222*6
3
$GLMLA,16,05,70,1176,01,140f,49,45c4,8000,34c0bc,076637,0a3e40,002214,099,036*3
7
$GLMLA,16,06,71,1176,05,0306,4c,5133,8000,34c025,09bda7,085d84,001f83,099,21d*6
E
$GLMLA,16,07,72,1176,06,01b1,4c,4c19,8000,34c021,0c35a0,067db8,001fca,099,047*3
D
$GLMLA,16,08,74,1176,84,076b,45,7995,8000,34c07b,104b6d,0e1557,002a38,099,040*3
5
$GLMLA,16,09,78,1176,84,066c,46,78cf,8000,34c07b,0663f0,1a6239,0029df,099,030*3
8
$GLMLA,16,10,79,1176,80,0afc,45,8506,8000,34c057,08de48,1c44ca,0029d7,099,000*6
B
$GLMLA,16,11,82,1176,8a,12d3,0f,e75d,8000,34be85,10aea6,1781b7,00235a,099,207*6
E
```

```
$GLMLA,16,12,83,1176,03,0866,0f,6c08,8000,34c009,11f32e,18839d,002b22,099,214*36
```

```
$GLMLA,16,13,85,1176,88,01a6,0d,9dc9,8000,34bff8,031887,02da1e,002838,099,242*6D
```

```
$GLMLA,16,14,86,1176,8a,00e1,0e,4b15,8000,34c016,058181,010433,0027f0,099,227*6F
```

```
$GLMLA,16,15,87,1176,03,0383,0f,824c,8000,34bfda,081864,1104ea,002b04,099,00c*60
```

```
$GLMLA,16,16,88,1176,02,0821,0f,8ac8,8000,34c05b,0a8510,12dcb6,002b6f,099,020*3F
```

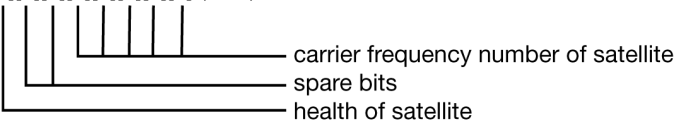

Refer to the GLONASS section of [An Introduction to GNSS](#) available on our website.

Field	Structure	Description	Symbol	Example
1	\$GLMLA	Log header. See <i>Messages</i> on page 27 for more information.		\$GLMLA
2	#alm	Number of NMEA almanac messages in the set	x.x	16
3	alm#	Current message number	x.x	13
4	slot	Slot number for satellite (65-96) The NMEA GLONASS PRN numbers are 64 plus the GLONASS slot number. Current slot numbers are 1 to 24 which give the range 65 to 88. PRN numbers 89 to 96 are available if slot numbers above 24 are allocated to on-orbit spares.	xx	85
5	N	Calendar day count within the four year period from the last leap year	x.x	1176
6	hlth & freq	Health and frequency for satellite Health and carrier frequency numbers are represented in this 2-character Hex field as: hh = [8][7][6][5][4][3][2][1] (LSB) 	hh	88
7	ecc	Eccentricity ¹	hhhh	01a6
8	ΔTdot	Rate of change of orbital period (s/orbital period ²) ¹	hh	0d

¹The LSB of the Hex data field corresponds to the LSB of the word indicated in the Table 4.3 of the GLONASS Interface Control Document, 1995. If the number of available bits in the Hex field is greater than the word, the MSB (upper bits) are unused and filled with zeroes.

Field	Structure	Description	Symbol	Example
9	w	Argument of perigee (PZ-90.02) (radians) ¹	hhhh	9dc9
10	t _{16MSB}	Clock offset, in seconds (s) ¹	hhhh	8000
11	ΔT	Correction to the mean value of the Draconian period (s/orbital period) ¹	hhhhhh	34bff8
12	tn	GLONASS Time of ascending node equator crossing (s) ¹	hhhhhhh	031887
13	l	Longitude of ascending node equator crossing (PZ-90.02) (radians) ¹	hhhhhhh	02da1e
14	Δi	Correction to nominal inclination (radians) ¹	hhhhhhh	002838
15	t _{12LSB}	Clock offset (s) ¹	hhh	099
16	t	Coarse value of the time scale shift ¹	hhh	242
17	xxxx	32-bit CRC (ASCII and Binary only)	Hex	*6D
18	[CR][LF]	Sentence terminator (ASCII only)	-	[CR][LF]

3.36 GLOALMANAC

Decoded GLONASS Almanac

Platform: OEM719, OEM729, OEM7500, OEM7600, OEM7700, OEM7720, PwrPak7, SPAN CPT7, SMART7, SMART2

The GLONASS almanac reference time and week are in GPS reference time coordinates. GLONASS ephemeris information is available through the **GLOEPHEMERIS** command (see page 431).

Nominal orbit parameters of the GLONASS satellites are as follows:

- Draconian period - 11 hours 15 minutes 44 seconds (see fields 14 and 15 in the following table)
- Orbit altitude - 19100 km
- Inclination - 64.8 (see field 11)
- Eccentricity - 0 (see field 12)

The OEM7 family of receivers automatically save almanacs in their Non-Volatile Memory (NVM), so creating an almanac boot file is not necessary.



The speed at which the receiver locates and locks onto new satellites is improved if the receiver has approximate time and position (**SETAPPROXTIME** and **SETAPPROXPOS**), as well as an almanac. This allows the receiver to compute the elevation of each satellite so it can tell which satellites are visible and their Doppler offsets, improving Time to First Fix (TTFF).

Message ID: 718

Log Type: Asynch

Recommended Input:

```
log gloalmanaca onchanged
```

ASCII Example:

```
#GLOALMANACA, COM1, 0, 52.5, SATTIME, 1364, 410744.000, 02000000, ba83, 2310;
24,
1364, 336832.625, 1, 2, 0, 0, 2018.625000000, -2.775537500, 0.028834045,
0.001000404, 2.355427500, -2656.076171875, 0.000000000, 0.000091553,
1364, 341828.437, 2, 1, 0, 0, 7014.437500000, -3.122226146, 0.030814438,
0.004598618, 1.650371580, -2656.160156250, 0.000061035, 0.000095367,
1364, 347002.500, 3, 12, 0, 0, 12188.500000000, 2.747629236, 0.025376596,
0.002099991, -2.659059822, -2656.076171875, -0.000061035, -0.000198364,
1364, 351887.125, 4, 6, 0, 0, 17073.125000000, 2.427596502, 0.030895332,
0.004215240, 1.438586358, -2656.167968750, -0.000061035, 0.000007629,
.
.
.
```

```

1364,364031.187,23,11,0,1,29217.187500000,0.564055522,0.030242192,
0.001178741,2.505278248,-2655.957031250,0.000366211,0.000019073,

1364,334814.000,24,3,0,1,0.000000000,0.000000000,0.000000000,
0.000000000,0.000000000,0.000000000,0.000000000,0.000000000
*4dc981c7

```

Field	Field type	Description	Format	Binary Bytes	Binary Offset
1	GLOALMANAC header	Log header. See <i>Messages</i> on page 27 for more information.		H	0
2	#recs	The number of GLONASS almanac records to follow. Set to zero until almanac data is available	Long	4	H
3	week	GPS reference week, in weeks	Ulong	4	H+4
4	time	GPS reference time, in milliseconds (binary data) or seconds (ASCII data)	GPSec	4	H+8
5	slot	Slot number for satellite, ordinal	Uchar	1	H+12
6	frequency	Frequency for satellite, ordinal (frequency channels are in the range -7 to +6)	Char	1	H+13
7	sat type	Satellite type where 0 = GLO_SAT 1 = GLO_SAT_M (M type) 2 = GLO_SAT_K (K type)	Uchar	1	H+14
8	health	Satellite status where 0 = OPERATIONAL 1 = MALFUNCTION	Uchar	1	H+15
9	TlambdaN	GLONASS Time of ascending node equator crossing (s)	Double	8	H+16
10	lambdaN	Longitude of ascending node equator crossing (PZ-90.02) (radians)	Double	8	H+24
11	deltaI	Correction to nominal inclination (radians)	Double	8	H+32
12	ecc	Eccentricity	Double	8	H+40
13	ArgPerig	Argument of perigee (PZ-90.02) (radians)	Double	8	H+48
14	deltaT	Correction to the mean value of the Draconian period (s/orbital period)	Double	8	H+56
15	deltaTD	Rate of change of orbital period (s/orbital period ²)	Double	8	H+64

Field	Field type	Description	Format	Binary Bytes	Binary Offset
16	tau	Clock offset (s)	Double	8	H+72
17	Next message offset = H + 4 + (#recs x 76)				
18	xxxx	32-bit CRC (ASCII and Binary only)	Ulong	4	H+4+ (76 x #recs)
19	[CR][LF]	Sentence terminator (ASCII only)	-	-	-

3.37 GLOCLOCK

GLONASS clock information

Platform: OEM719, OEM729, OEM7500, OEM7600, OEM7700, OEM7720, PwrPak7, SPAN CPT7, SMART7, SMART2

This log contains the time difference information between GPS and GLONASS time as well as status flags. The status flags are used to indicate the type of time processing used in the least squares adjustment. GPS and GLONASS time are both based on the Universal Time Coordinated (UTC) time scale with some adjustments. GPS reference time is continuous and does not include any of the leap second adjustments to UTC applied since 1980. The result is that GPS reference time currently leads UTC time by 15 seconds.

GLONASS time applies leap seconds but is also three hours ahead to represent Moscow time. The nominal offset between GPS and GLONASS time is therefore due to the three hour offset minus the leap second offset. As well as the nominal offset, there is a residual offset on the order of nanoseconds which must be estimated in the least squares adjustment. The GLONASS-M satellites broadcasts this difference in the navigation message.

This log also contains information from the GLONASS navigation data relating GLONASS time to UTC.

Message ID: 719

Log Type: Asynch

Recommended Input:

```
log gloclocka onchanged
```

ASCII Example:

```
#GLOCLOCKA,COM1,0,54.5,SATTIME,1364,411884.000,02000000,1d44,2310;
0,0.000000000,0.000000000,0,0,-0.000000275,792,-0.000001207,
0.000000000,0.000000000,0*437e9afaf
```

Field	Field type	Description	Format	Binary Bytes	Binary Offset
1	GLOCLOCK header	Log header. See <i>Messages</i> on page 27 for more information.		H	0
2	Reserved		Ulong	4	H
3			Double	8	H+4
4			Double	8	H+12
5	sat type	Satellite type where 0 = GLO_SAT 1 = GLO_SAT_M (M type) 2 = GLO_SAT_K (K type)	Uchar	1	H+20

Field	Field type	Description	Format	Binary Bytes	Binary Offset
6	N ⁴	Four-year interval number starting from 1996	Uchar	1 ¹	H+21
7	T _{GPS}	Correction to GPS time relative to GLONASS time	Double	8	H+24
8	N ^A	GLONASS calendar day number within a four year period beginning since the leap year, in days	Ushort	2 ¹	H+32
9	T _C	GLONASS time scale correction to UTC(SU) given at beginning of day N ⁴ (s)	Double	8	H+36
10	b1	Beta parameter 1st order term	Double	8	H+44
11	b2	Beta parameter 2nd order term	Double	8	H+52
12	Kp	Kp provides notification of the next expected leap second. For more information, see <i>Table 82: Kp UTC Leap Second Descriptions</i> below	Uchar	1	H+60
13	xxxx	32-bit CRC (ASCII and Binary only)	Ulong	4	H+61
14	[CR][LF]	Sentence terminator (ASCII only)	-	-	-

Table 82: Kp UTC Leap Second Descriptions

Kp	Information on UTC Leap Second ²
00	No UTC update for this quarter
01	UTC update of plus 1 second at the end of current quarter
11	UTC update of minus 1 second at end of current quarter

¹In the binary log case, additional bytes of padding are added to maintain 4-byte alignment.

²Based on GLONASS ICD version 5.1, 2008.

3.38 GLOEPHEMERIS

Decoded GLONASS ephemeris

Platform: OEM719, OEM729, OEM7500, OEM7600, OEM7700, OEM7720, PwrPak7, SPAN CPT7, SMART7, SMART2

This log contains GLONASS ephemeris information. GLONASS ephemerides are referenced to the PZ90.02 geodetic datum. No adjustment between the GPS and GLONASS reference frames are made for positioning. Multiple messages are transmitted, one for each SVID with data.

Message ID: 723

Log Type: Asynch

Recommended Input:

```
log gloephemerisa onchanged
```

Example:

```
#GLOEPHEMERISA, COM1, 3, 49.0, SATTIME, 1364, 413624.000, 02000000, 6b64, 2310;
43, 8, 1, 0, 1364, 413114000, 10786, 792, 0, 0, 87, 0, 9.0260864257812500e+06,
-6.1145468750000000e+06, 2.2926090820312500e+07, 1.4208841323852539e+03,
2.8421249389648438e+03, 1.9398689270019531e+02, 0.0000000000000000,
-2.79396772384643555e-06, -2.79396772384643555e-06, 2.12404876947402954e
-04, -1.396983862e-08, -3.63797880709171295e-12, 78810, 3, 15, 0, 12*a02ce18b

#GLOEPHEMERISA, COM1, 2, 49.0, SATTIME, 1364, 413626.000, 02000000, 6b64, 2310;
44, 11, 1, 0, 1364, 413116000, 10784, 792, 0, 0, 87, 13, -1.2882617187500000e+06,
-1.9318657714843750e+07, 1.6598909179687500e+07, 9.5813846588134766e+02,
2.0675134658813477e+03, 2.4769935607910156e+03, 2.79396772384643555e-06,
-3.72529029846191406e-06, -1.86264514923095703e-06, 6.48368149995803833e
-05, -4.656612873e-09, 3.63797880709171295e-12, 78810, 3, 15, 3, 28*e2d5ef15

#GLOEPHEMERISA, COM1, 1, 49.0, SATTIME, 1364, 413624.000, 02000000, 6b64, 2310;
45, 13, 0, 0, 1364, 413114000, 10786, 0, 0, 0, 87, 0, -1.1672664062500000e+07,
-2.2678505371093750e+07, 4.8702343750000000e+05, -1.1733341217041016e+02,
1.3844585418701172e+02, 3.5714883804321289e+03, 2.79396772384643555e-06,
-2.79396772384643555e-06, 0.0000000000000000, -4.53162938356399536e-05,
5.587935448e-09, -2.36468622460961342e-11, 78810, 0, 0, 0, 8*c15abfeb

#GLOEPHEMERISA, COM1, 0, 49.0, SATTIME, 1364, 413624.000, 02000000, 6b64, 2310;
59, 17, 0, 0, 1364, 413114000, 10786, 0, 0, 0, 87, 0, -2.3824853515625000e+05,
-1.6590188964843750e+07, 1.9363733398437500e+07, 1.3517074584960938e+03,
-2.2859592437744141e+03, -1.9414072036743164e+03, 1.86264514923095703e-0
6, -3.72529029846191406e-06, -1.86264514923095703e-06, 7.9257413744926452
6e-05, 4.656612873e-09, 2.72848410531878471e-12, 78810, 0, 0, 0, 12*ed7675f5
```

Field	Field type	Description	Format	Binary Bytes	Binary Offset
1	GLOEPHEMERIS header	Log header. See <i>Messages</i> on page 27 for more information.		H	0

Field	Field type	Description	Format	Binary Bytes	Binary Offset
2	sloto	Slot information offset - PRN identification (Slot + 37). This is also called SLOTO in Connect	Ushort	2	H
3	frequ	Frequency channel offset for satellite in the range 0 to 20	Ushort	2	H+2
4	sat type	Satellite type where 0 = GLO_SAT 1 = GLO_SAT_M (M type) 2 = GLO_SAT_K (K type)	Uchar	1	H+4
5	Reserved			1	H+5
6	e week	Reference week of ephemeris (GPS reference time)	Ushort	2	H+6
7	e time	Reference time of ephemeris (GPS reference time) (ms)	Ulong	4	H+8
8	t offset	Integer seconds between GPS and GLONASS time. A positive value implies GLONASS is ahead of GPS reference time.	Ulong	4	H+12
9	Nt	Calendar number of day within 4 year interval starting at Jan 1 of a leap year	Ushort	2	H+16
10	Reserved			1	H+18
11				1	H+19
12	issue	15 minute interval number corresponding to ephemeris reference time	Ulong	4	H+20
13	health ¹	Ephemeris health where 0-3 = GOOD 4-15 = BAD	Ulong	4	H+24
14	pos x	X coordinate for satellite at reference time (PZ-90.02) (m)	Double	8	H+28
15	pos y	Y coordinate for satellite at reference time (PZ-90.02) (m)	Double	8	H+36

¹The last four bits of this field are used to describe the health.

Bit 0-2: Bn

Bit 3: In

All other bits are reserved and set to 0.

Field	Field type	Description	Format	Binary Bytes	Binary Offset
16	pos z	Z coordinate for satellite at reference time (PZ-90.02) (m)	Double	8	H+44
17	vel x	X coordinate for satellite velocity at reference time (PZ-90.02) (m/s)	Double	8	H+52
18	vel y	Y coordinate for satellite velocity at reference time (PZ-90.02) (m/s)	Double	8	H+60
19	vel z	Z coordinate for satellite velocity at reference time (PZ-90.02), (m/s)	Double	8	H+68
20	LS acc x	X coordinate for lunisolar acceleration at reference time (PZ-90.02), (m/s/s)	Double	8	H+76
21	LS acc y	Y coordinate for lunisolar acceleration at reference time (PZ-90.02) (m/s/s)	Double	8	H+84
22	LS acc z	Z coordinate for lunisolar acceleration at reference time (PZ-90.02) (m/s/s)	Double	8	H+92
23	tau_n	Correction to the nth satellite time t_n relative to GLONASS time t_c (s)	Double	8	H+100
24	delta_tau_n	Time difference between navigation RF signal transmitted in L2 sub-band and navigation RF signal transmitted in L1 sub-band by nth satellite (s)	Double	8	H+108
25	gamma	Frequency correction (s/s)	Double	8	H+116
26	Tk	Time of frame start (since start of GLONASS day) (s)	Ulong	4	H+124
27	P	Technological parameter	Ulong	4	H+128
28	Ft	User range	Ulong	4	H+132
29	age	Age of data (days)	Ulong	4	H+136
30	Flags	Information flags, see <i>Table 83: GLONASS Ephemeris Flags Coding</i> on the next page	Ulong	4	H+140
31	xxxx	32-bit CRC (ASCII and Binary only)	Ulong	4	H+144
32	[CR][LF]	Sentence terminator (ASCII only)	-	-	-

Table 83: GLONASS Ephemeris Flags Coding

Nibble Number	Bit	Description	Range Values	Hex Value
N0	0	P1 Flag - Time interval between adjacent iISSUE (fb) values	See Table 84: P1 Flag Range Values below	00000001
	1			00000002
	2	P2 Flag - Oddness or Evenness of iISSUE (fb) value	0 = even 1 = odd	00000004
	3	P3 Flag - Number of satellites with almanac information within current subframe	0 = four 1 = five	00000008
N-1 through N-7	4 ... 31	Reserved		

Table 84: P1 Flag Range Values

State	Description
00	0 minutes
01	30 minutes
10	45 minutes
11	60 minutes

3.39 GLORAWALM

Raw GLONASS Almanac data

Platform: OEM719, OEM729, OEM7500, OEM7600, OEM7700, OEM7720, PwrPak7, SPAN CPT7, SMART7, SMART2

This log contains the raw almanac subframes as received from the GLONASS satellite.

Message ID: 720

Log Type: Asynch

Recommended Input:

```
log glorawalma onchanged
```

Example:

```
#GLORAWALMA,COM1,0,44.5,SATTIME,1364,419924.000,02000000,77bb,2310;
1364,419954.069,54,
0563100000a40000000006f,0,
0681063c457a12cc0419be,0,
075ff807e2a69804e0040b,0,
0882067fcd80141692d6f2,0,
09433e1b6676980a40429b,0,
0a838d1bfcb4108b089a8c,0,
0bec572f9c869804f05882,0,
...
06950201e02e13d3819564,0,
07939a4a16fe97fe814ad0,0,
08960561cecc13b0014613,0,
09469a5d70c69802819466,0,
0a170165bed413b704d416,0,
0b661372213697fd41965a,0,
0c18000000000000000006,0,
0d000000000000000000652,0,
0e000000000000000000d0,0*b516623b
```

Field	Field type	Description	Format	Binary Bytes	Binary Offset
1	GLORAWALM header	Log header. See <i>Messages</i> on page 27 for more information.		H	0
2	week	GPS reference week, in weeks	Ulong	4	H
3	time	GPS reference time, in milliseconds (binary data) or seconds (ASCII data)	GPSTime	4	H+4
4	#recs	Number of records to follow	Ulong	4	H+8
5	string	GLONASS data string	String [11]	11	H+12

Field	Field type	Description	Format	Binary Bytes	Binary Offset
6	Reserved		Uchar	1	H+23
7	Next record offset = $H+8+(\#recs \times 12)$				
8	xxxx	32-bit CRC (ASCII and Binary only)	Ulong	4	H+12+ (#recsx12)
9	[CR][LF]	Sentence terminator (ASCII only)	-	-	-

3.40 GLORAWEPHEM

Raw GLONASS Ephemeris data

Platform: OEM719, OEM729, OEM7500, OEM7600, OEM7700, OEM7720, PwrPak7, SPAN CPT7, SMART7, SMART2

This log contains the raw ephemeris frame data as received from the GLONASS satellite.

Message ID: 792

Log Type: Asynch

Recommended Input:

```
log glorawephema onchanged
```

Example:

```
#GLORAWEPHEMA,COM1,3,47.0,SATTIME,1340,398653.000,02000000,332d,2020;
38,9,0,1340,398653.080,4,0148d88460fc115dbdaf78,0,0218e0033667aec83af
2a5,0,038000b9031e14439c75ee,0,0404f226600000000000065,0*17f3dd17
```

...

```
#GLORAWEPHEMA,COM1,0,47.0,SATTIME,1340,398653.000,02000000,332d,2020;
41,13,0,1340,398653.078,4,0108d812532805bfa1cd2c,0,0208e0a36e8e0952b1
11da,0,03c02023b68c9a32410958,0,0401fda440000000000002a,0*0b237405
```

Field	Field type	Description	Format	Binary Bytes	Binary Offset
1	GLORAWEPHEM header	Log header. See <i>Messages</i> on page 27 for more information.		H	0
2	sloto	Slot information offset - PRN identification (Slot + 37). Ephemeris relates to this slot and is also called SLOTO in NovAtel Connect	Ushort	2	H
3	freqo	Frequency channel offset in the range 0 to 20	Ushort	2	H+2
4	sigchan	Signal channel number	Ulong	4	H+4
5	week	GPS reference week, in weeks	Ulong	4	H+8
6	time	GPS reference time, in milliseconds (binary data) or seconds (ASCII data)	GPSec	4	H+12
7	#recs	Number of records to follow	Ulong	4	H+16
8	string	GLONASS data string	String [11]	11	H+20
9	Reserved		Uchar	1	H+31

Field	Field type	Description	Format	Binary Bytes	Binary Offset
10	Next record offset = $H+20+(\#recs \times 12)$				
11	xxxx	32-bit CRC (ASCII and Binary only)	Ulong	4	$H+20+(\#recs \times 12)$
12	[CR][LF]	Sentence terminator (ASCII only)	-	-	-

3.41 GLORAWFRAME

Raw GLONASS frame data

Platform: OEM719, OEM729, OEM7500, OEM7600, OEM7700, OEM7720, PwrPak7, SPAN CPT7, SMART7, SMART2

This log contains the raw GLONASS frame data as received from the GLONASS satellite. Multiple messages are transmitted, one for each SVID with data.

Message ID: 721

Log Type: Asynch

Recommended Input:

```
log glorawframea onchanged
```

Example:

```
#GLORAWFRAMEA,COM1,19,53.0,SATTIME,1340,398773.000,02000000,8792,2020;
3,39,8,1340,398773.067,44,44,15,0148dc0b67e9184664cb35,0,
0218e09dc8a3ae8c6ba18d,0,
...
0f000000000000000000000000,0*11169f9e
...
#GLORAWFRAMEA,COM1,0,53.0,SATTIME,1340,398713.000,02000000,8792,2020;
1,41,13,1340,398713.077,36,36,15,0108da12532805bfa1cdded,0,
0208e0a36e8e0952b111da,0,03c02023b68c9a32410958,0,
...
0f6efb59474697fd72c4e2,0*0a6267c8
```

Field	Field type	Description	Format	Binary Bytes	Binary Offset
1	GLORAWFRAME header	Log header. See <i>Messages</i> on page 27 for more information.		H	0
2	frame#	Frame number	Ulong	4	H
3	sloto	Slot information offset - PRN identification (Slot + 37). Ephemeris relates to this slot and is also called SLOTO in NovAtel Connect.	Ushort	2	H+4
4	freqo	Frequency channel offset in the range 0 to 20	Ushort	2	H+6
5	week	GPS Week, in weeks	Ulong	4	H+8
6	time	GPS Time, in milliseconds (binary data) or seconds (ASCII data)	GPSec	4	H+12
7	frame decode	Frame decoder number	Ulong	4	H+16

Field	Field type	Description	Format	Binary Bytes	Binary Offset
8	sigchan	Signal channel number	Ulong	4	H+20
9	#recs	Number of records to follow	Ulong	4	H+24
10	string	GLONASS data string	String [11]	11	H+28
11	Reserved		Uchar	1	H+39
12	Next record offset = H+28+ (#recs x 12)				
13	xxxx	32-bit CRC (ASCII and Binary only)	Ulong	4	H +28+ (#recs x 12)
14	[CR][LF]	Sentence terminator (ASCII only)	-	-	-

3.43 GPALM

Almanac data

Platform: OEM719, OEM729, OEM7500, OEM7600, OEM7700, OEM7720, PwrPak7, SPAN CPT7, SMART7, SMART2

This log outputs raw almanac data for each GPS satellite PRN contained in the broadcast message. A separate record is logged for each PRN, up to a maximum of 32 records. GPALM outputs these messages without waiting for a valid almanac. Instead, it uses a UTC time, calculated with default parameters. In this case, the UTC time status (see the **TIME** log on page 783) is set to WARNING since it may not be one hundred percent accurate. When a valid almanac is available, the receiver uses the real parameters. UTC time is then set to VALID. It takes a minimum of 12.5 minutes to collect a complete almanac following receiver boot-up. In the case of a GLONASS capable receiver, the UTC offset can be determined once the GLONASS ephemeris is decoded, which takes about 50 seconds. If an almanac was stored in NVM, the stored values are reported in the GPALM log once time is set on the receiver.



To obtain copies of ICD-GPS-200, refer to <https://www.gps.gov/technical/icwg/>.

Message ID: 217

Log Type: Asynch

Recommended Input:

```
log gpalm onchanged
```

Example:

```
$GPALM,28,01,01,1337,00,305a,90,1b9d,fd5b,a10ce9,ba0a5e,2f48f1,cccb76,006,001*27
$GPALM,28,02,02,1337,00,4aa6,90,0720,fd50,a10c5a,4dc146,d89bab,0790b6,fe4,000*70
.
.
.
$GPALM,28,24,26,1337,00,878c,90,1d32,fd5c,a10c90,1db6b6,2eb7f5,ce95c8,00d,000*23
$GPALM,28,25,27,1337,00,9cde,90,07f2,fd54,a10da5,adc097,562da3,6488dd,00e,000*2F
$GPALM,28,26,28,1337,00,5509,90,0b7c,fd59,a10cc4,a1d262,83e2c0,3003bd,02d,000*78
$GPALM,28,27,29,1337,00,47f7,90,1b20,fd58,a10ce0,d40a0b,2d570e,221641,122,006*7D
$GPALM,28,28,30,1337,00,4490,90,0112,fd4a,a10cc1,33d10a,81dfc5,3bdb0f,178,004*28
```



See the *The NMEA (National Marine Electronics Association) has defined standards that specify how electronic equipment for marine users communicate. GNSS receivers are part of this standard and the NMEA has defined the format for several GNSS data logs otherwise known as 'sentences'*. on the next page that applies to all NMEA logs.

Field	Structure	Description	Symbol	Example
1	\$GPALM	Log header. See <i>Messages</i> on page 27 for more information.		\$GPALM
2	# msg	Total number of messages logged. Set to zero until almanac data is available	x.x	17
3	msg #	Current message number ¹	x.x	17
4	PRN	Satellite PRN number: GPS = 1 to 32	xx	28
5	GPS wk	GPS reference week number	x.x	653
6	SV hlth	SV health, bits 17-24 of each almanac page ²	hh	00
7	ecc	e, eccentricity ³	hhhh	3EAF
8	alm ref time	to a almanac reference time ³	hh	87
9	incl angle	(sigma)i, inclination angle ³	hhhh	OD68
10	omegadot	OMEGADOT, rate of right ascension ³	hhhh	FD30
11	rt axis	(A) ^{1/2} , root of semi-major axis ³	hhhhhh	A10CAB
12	omega	omega, argument of perigee ³	hhhhhh	6EE732
13	long asc node	(OMEGA) ^o , longitude of ascension node ³	hhhhhh	525880
14	Mo	Mo, mean anomaly ³	hhhhhh	6DC5A8
15	af0	af0, clock parameter ³	hhh	009
16	af1	af1, clock parameter ³	hhh	005
17	*xx	Check sum	*hh	*37
18	[CR][LF]	Sentence terminator		[CR][LF]

¹Variable length integer, 4-digits maximum from (2) most significant binary bits of Subframe 1, Word 3 reference Table 20-I, IS-GPS-200J, and (8) least significant bits from subframe 5, page 25, word 3 reference Table 20-I.

²Reference paragraph 20.3.3.5.1.3, Table 20-VII and Table 20-VIII, IS-GPS-200J.

³Reference Table 20-VI, IS-GPS-200J for scaling factors and units.

3.44 GPGGA

GPS fix data and undulation

Platform: OEM719, OEM729, OEM7500, OEM7600, OEM7700, OEM7720, PwrPak7, SPAN CPT7, SMART7, SMART2

This log contains time, position and fix related data of the GNSS receiver. See also *Table 87: Position Precision of NMEA Logs* on page 450.

The GPGGA log outputs these messages without waiting for a valid almanac. Instead, it uses a UTC time, calculated with default parameters. In this case, the UTC time status (see the **TIME** log on page 783) is set to WARNING since it may not be one hundred percent accurate. When a valid almanac is available, the receiver uses the real parameters. Then the UTC time status is set to VALID.



The GPGGA log can be customized using the **NMEAFORMAT** command (see page 193).



The position for the **GPGGA** log is reported in the user selected datum. See the **DATUM** command on page 100 for more details.

Message ID: 218

Log Type: Synch

Recommended Input:

```
log gpgga ontime 1
```

Example:

```
$GPGGA,134658.00,5106.9792,N,11402.3003,W,2,09,1.0,1048.47,M,-16.27,M,08,AAAA*60
```



The NMEA (National Marine Electronics Association) has defined standards that specify how electronic equipment for marine users communicate. GNSS receivers are part of this standard and the NMEA has defined the format for several GNSS data logs otherwise known as 'sentences'.

Each NMEA sentence begins with a '\$' followed by a two-letter prefix identifying the type of sending device (for example 'GP', 'GL' or 'GN'), followed by a sequence of letters that define the type of information contained in the sentence. Data contained within the sentence is separated by commas and the sentence is terminated with a two digit checksum followed by a carriage return/line feed. Here is an example of a NMEA sentence describing time, position and fix related data:

```
$GPGGA,134658.00,5106.9792,N,11402.3003,W,2,09,1.0,1048.47,M,-16.27,M,08,AAAA*60
```

The GPGGA sentence shown above and other NMEA logs are output the same no matter what GNSS receiver is used, providing a standard way to communicate and process GNSS information. For more information about NMEA, see the **NMEATALKER** command on page 196.

Field	Structure	Description	Symbol	Example
1	\$GPGGA	Log header. See <i>Messages</i> on page 27 for more information.		\$GPGGA
2	utc	UTC time status of position (hours/minutes/seconds/ decimal seconds)	hhmmss.ss	202134.00
3	lat	Latitude (DDmm.mm)	llll.ll	5106.9847
4	lat dir	Latitude direction (N = North, S = South)	a	N
5	lon	Longitude (DDDmm.mm)	yyyyy.yy	11402.2986
6	lon dir	Longitude direction (E = East, W = West)	a	W
7	quality	refer to <i>Table 85: GPS Quality Indicators</i> below	x	1
8	# sats	Number of satellites in use. May be different to the number in view	xx	10
9	hdop	Horizontal dilution of precision	x.x	1.0
10	alt	Antenna altitude above/below mean sea level	x.x	1062.22
11	a-units	Units of antenna altitude (M = meters)	M	M
12	undulation	Undulation - the relationship between the geoid and the WGS84 ellipsoid	x.x	-16.271
13	u-units	Units of undulation (M = meters)	M	M
14	age	Age of correction data (in seconds) The maximum age reported here is limited to 99 seconds.	xx	(empty when no differential data is present)
15	stn ID	Differential base station ID	xxxx	(empty when no differential data is present)
16	*xx	Check sum	*hh	*48
17	[CR][LF]	Sentence terminator		[CR][LF]

Table 85: GPS Quality Indicators

Indicator	Description
0	Fix not available or invalid

Indicator	Description
1	Single point
	Converging PPP (TerraStar-L)
2	Pseudorange differential
	Converged PPP (TerraStar-L)
	Converging PPP (TerraStar-C, TerraStar-C PRO, TerraStar-X)
4	RTK fixed ambiguity solution
5	RTK floating ambiguity solution
	Converged PPP (TerraStar-C, TerraStar-C PRO, TerraStar-X)
6	Dead reckoning mode
7	Manual input mode (fixed position)
8	Simulator mode
9	WAAS (SBAS) ¹



Refer to the **BESTPOS** log (see page 371) and *Table 70: Supplemental Position Types and NMEA Equivalents* on page 379.

¹An indicator of 9 has been temporarily set for SBAS (NMEA standard for SBAS not decided yet). This indicator can be customized using the GGAQUALITY command.

3.45 GPGGALONG

Fix data, extra precision and undulation

Platform: OEM719, OEM729, OEM7500, OEM7600, OEM7700, OEM7720, PwrPak7, SPAN CPT7, SMART7, SMART2

This log contains, time, position, undulation and fix related data of the GNSS receiver. This is output as a GPGGA log but the GPGGALONG log differs from the normal GPGGA log by its extra precision. See also *Table 87: Position Precision of NMEA Logs* on page 450.

The GPGGALONG log outputs these messages without waiting for a valid almanac. Instead, it uses a UTC time, calculated with default parameters. In this case, the UTC time status is set to WARNING since it may not be one hundred percent accurate. When a valid almanac is available, the receiver uses the real parameters. Then the UTC time status is set to VALID.



The GPGGALONG log can be customized using the **NMEAFORMAT** command (see page 193).

Message ID: 521

Log Type: Synch

Recommended Input:

```
log gpggalong ontime 1
```

Example 1:

```
$GPGGA,181126.00,5106.9802863,N,11402.3037304,W,7,11,0.9,1048.234,M,-16.27,M,,*51
```

Example 2:

```
$GPGGA,134658.00,5106.9802863,N,11402.3037304,W,2,09,1.0,1048.234,M,-16.27,M,08,AAAA
```



See the Note in the **GPGGA** log (see page 444) that applies to all NMEA logs.

Field	Structure	Description	Symbol	Example
1	\$GPGGALONG	Log header		\$GPGGA
2	utc	UTC time status of position (hours/minutes/seconds/ decimal seconds)	hhmmss.ss	202126.00
3	lat	Latitude (DDmm.mm)	IIII.II	5106.9847029
4	lat dir	Latitude direction (N = North, S = South)	a	N
5	lon	Longitude (DDDmm.mm)	yyyyy.yy	11402.2986286

Field	Structure	Description	Symbol	Example
6	lon dir	Longitude direction (E = East, W = West)	a	W
7	GPS qual	Refer to <i>Table 85: GPS Quality Indicators</i> on page 445	x	1
8	# sats	Number of satellites in use (00-12). May be different to the number in view	xx	10
9	hdop	Horizontal dilution of precision	x.x	1.0
10	alt	Antenna altitude above/below msl	x.x	1062.376
11	units	Units of antenna altitude (M = meters)	M	M
12	undulation	Undulation - the relationship between the geoid and the WGS84 ellipsoid	x.x	-16.271
13	u-units	Units of undulation (M = meters)	M	M
14	age	Age of Differential GPS data (in seconds) The maximum age reported here is limited to 99 seconds.	xx	10 (empty when no differential data is present)
15	stn ID	Differential base station ID, 0000-1023	xxxx	AAAA (empty when no differential data is present)
16	*xx	Check sum	*hh	*48
17	[CR][LF]	Sentence terminator		[CR][LF]

Table 86: Position Precision of NMEA Logs

NMEA Log	Latitude (# of decimal places)	Longitude (# of decimal places)	Altitude (# of decimal places)
GPGGA	4	4	2
GPGGALONG	7	7	3
GPGLL	7	7	N/A
GPRMC	7	7	N/A



Refer to the **BESTPOS** log (see page 371) and *Table 70: Supplemental Position Types and NMEA Equivalents* on page 379.

3.46 GPGLL

Geographic position

Platform: OEM719, OEM729, OEM7500, OEM7600, OEM7700, OEM7720, PwrPak7, SPAN CPT7, SMART7, SMART2

This log contains latitude and longitude of present vessel position, time of position fix and status.

Table 87: Position Precision of NMEA Logs on the next page compares the position precision of selected NMEA logs.

The GPGLL log outputs these messages without waiting for a valid almanac. Instead, it uses a UTC time, calculated with default parameters. In this case, the UTC time status (see the **TIME** log on page 783) is set to WARNING since it may not be one hundred percent accurate. When a valid almanac is available, the receiver uses the real parameters. Then the UTC time status is set to VALID.



If the **NMEATALKER** command (see page 196) is set to AUTO, the talker (the first 2 characters after the \$ sign in the log header) is set to GP (GPS satellites only), GL (GLONASS satellites only) or GN (satellites from both systems) or GA (Galileo satellites only).



The position for the **GPGLL** log is reported in the user selected datum. See the **DATUM** command on page 100 for more details.

Message ID: 219

Log Type: Synch

Recommended Input:

```
log gppll ontime 1
```

Example 1 (GPS only):

```
$GPGLL,5107.0013414,N,11402.3279144,W,205412.00,A,A*73
```

Example 2 (Combined GPS and GLONASS):

```
$GNGLL,5107.0014143,N,11402.3278489,W,205122.00,A,A*6E
```



See the Note in the **GPGLL** log (see page 444) that applies to all NMEA logs.

Field	Structure	Description	Example
1	\$GPGLL	Log header. See <i>Messages</i> on page 27 for more information.	\$GPGLL
2	lat	Latitude (DDmm.mm)	5106.7198674

Field	Structure	Description	Example
3	lat dir	Latitude direction (N = North, S = South)	N
4	lon	Longitude (DDDmm.mm)	11402.3587526
5	lon dir	Longitude direction (E = East, W = West)	W
6	utc	UTC time status of position (hours/minutes/seconds/decimal seconds)	220152.50
7	data status	Data status: A = Data valid, V = Data invalid	A
8	mode ind	Positioning system mode indicator, see <i>Table 88: NMEA Positioning System Mode Indicator</i> below	A
9	*xx	Check sum	*1B
10	[CR][LF]	Sentence terminator	[CR][LF]

Table 87: Position Precision of NMEA Logs

NMEA Log	Latitude (# of decimal places)	Longitude (# of decimal places)	Altitude (# of decimal places)
GPGGA	4	4	2
GPGGALONG	7	7	3
GPGLL	7	7	N/A
GPRMC	7	7	N/A

Table 88: NMEA Positioning System Mode Indicator

Mode	Indicator
A	Autonomous
D	Differential
E	Estimated (dead reckoning) mode
M	Manual input
N	Data not valid

3.47 GPGRS

GPS range residuals for each satellite

Platform: OEM719, OEM729, OEM7500, OEM7600, OEM7700, OEM7720, PwrPak7, SPAN CPT7, SMART7, SMART2

Range residuals can be computed in two ways, and this log reports those residuals. Under mode 0, residuals output in this log are used to update the position solution output in the GPGGGA message. Under mode 1, the residuals are recomputed after the position solution in the GPGGGA message is computed. The receiver computes range residuals in mode 1. An integrity process using GPGRS would also require GPGGGA (for position fix data), GPGSA (for DOP figures) and GPGSV (for PRN numbers) for comparative purposes.

The GPGRS log outputs these messages without waiting for a valid almanac. Instead, it uses a UTC time, calculated with default parameters. In this case, the UTC time status (see the **TIME** log on page 783) is set to WARNING since it may not be one hundred percent accurate. When a valid almanac is available, the receiver uses the real parameters. Then the UTC time status is set to VALID.



1. If the range residual exceeds ± 99.9 , then the decimal part is dropped. Maximum value for this field is ± 999 . The sign of the range residual is determined by the order of parameters used in the calculation as follows:

$$\text{range residual} = \text{calculated range} - \text{measured range}$$

2. If the **NMEATALKER** command (see page 196) is set to AUTO, the talker (the first 2 characters after the \$ sign in the log header) is set to GP (GPS satellites only), GL (GLONASS satellites only), GN (GPS and GLONASS satellites) or GA (Galileo satellites only).



The position for the **GPRMC** log is reported in the user selected datum. See the **DATUM** command on page 100 for more details.

Message ID: 220

Log Type: Synch

Recommended Input:

```
log gpgrs ontime 1
```

Example 1 (GPS only):

```
$GPGRS,142406.00,1,-1.1,-0.1,1.7,1.2,-2.0,-0.5,1.2,-1.2,-0.1,,, *67
```

Example 2 (Combined GPS and GLONASS):

```
$GNGRS,143209.00,1,-0.2,-0.5,2.2,1.3,-2.0,-1.3,1.3,-0.4,-1.2,-0.2,,, *72
```

```
$GNGRS,143209.00,1,1.3,-6.7,,,,,,,,,,,, *73
```



See the Note in the **GPGGGA** log (see page 444) that applies to all NMEA logs.

Field	Structure	Description	Symbol	Example
1	\$GPGRS	Log header. See <i>Messages</i> on page 27 for more information.		\$GPGRS
2	utc	UTC time status of position (hours/minutes/seconds/decimal seconds)	hhmmss.ss	192911.0
3	mode	Mode 0= residuals were used to calculate the position given in the matching GGA line (apriori) (not used by OEM7 receivers) Mode 1= residuals were recomputed after the GGA position was computed (preferred mode)	x	1
4 - 15	res	Range residuals for satellites used in the navigation solution. Order matches order of PRN numbers in GPGSA	x.x,x.x,.....	-13.8,- 1.9,11.4,- 33.6,0.9, 6.9,- 12.6,0.3,0.6, -22.3
16	*xx	Check sum	*hh	*65
17	[CR][LF]	Sentence terminator		[CR][LF]

3.48 GPGSA

GPS DOP and active satellites

Platform: OEM719, OEM729, OEM7500, OEM7600, OEM7700, OEM7720, PwrPak7, SPAN CPT7, SMART7, SMART2

This log contains GNSS receiver operating mode, satellites used for navigation and DOP values.

The GPGSA log outputs these messages without waiting for a valid almanac. Instead, it uses a UTC time, calculated with default parameters. In this case, the UTC time status (see the **TIME** log on page 783) is set to WARNING since it may not be one hundred percent accurate. When a valid almanac is available, the receiver uses the real parameters. Then the UTC time status is set to VALID.



If the **NMEATALKER** command (see page 196) is set to AUTO, the talker (the first 2 characters after the \$ sign in the log header) is set to GP (GPS satellites only), GL (GLONASS satellites only), or GN (satellites from both systems) or GA (Galileo satellites only).

Message ID: 221

Log Type: Synch

Recommended Input:

```
log gpgsa ontime 1
```

Example 1 (GPS only):

```
$GPGSA,M,3,17,02,30,04,05,10,09,06,31,12,,,1.2,0.8,0.9*35
```

Example 2 (Combined GPS and GLONASS):

```
$GNGSA,M,3,17,02,30,04,05,10,09,06,31,12,,,1.2,0.8,0.9*2B
```

```
$GNGSA,M,3,87,70,,,,,,,,,,,,,1.2,0.8,0.9*2A
```



The DOPs provide a simple characterization of the user satellite geometry. DOP is related to the volume formed by the intersection points of the user satellite vectors, with the unit sphere centered on the user. Larger volumes give smaller DOPs. Lower DOP values generally represent better position accuracy. The role of DOP in GNSS positioning is often misunderstood. A lower DOP value does not automatically mean a low position error. The quality of a GNSS derived position estimate depends upon both the measurement geometry as represented by DOP values and range errors caused by signal strength, ionospheric effects, multipath and so on.



See the Note in the **GPGGA** log (see page 444) that applies to all NMEA logs.

Field	Structure	Description	Symbol	Example
1	\$GPGSA	Log header. See <i>Messages</i> on page 27 for more information.		\$GPGSA
2	mode MA	A = Automatic 2D/3D M = Manual, forced to operate in 2D or 3D	M	M
3	mode 123	Mode: 1 = Fix not available; 2 = 2D; 3 = 3D	x	3
4 - 15	prn	PRN numbers of satellites used in solution (null for unused fields), total of 12 fields GPS = 1 to 32 SBAS = 33 to 64 (add 87 for PRN number) GLO = 65 to 96 ¹	xx,xx,.....	18,03,13, 25,16, 24,12, 20,,,,
16	pdop	Position dilution of precision	x.x	1.5
17	hdop	Horizontal dilution of precision	x.x	0.9
18	vdop	Vertical dilution of precision	x.x	1.2
19	*xx	Check sum	*hh	*3F
20	[CR][LF]	Sentence terminator		[CR][LF]

¹The NMEA GLONASS PRN numbers are 64 plus the GLONASS slot number. Current slot numbers are 1 to 24 which give the range 65 to 88. PRN numbers 89 to 96 are available if slot numbers above 24 are allocated to on-orbit spares.

3.49 GPGST

Estimated error in position solution

Platform: OEM719, OEM729, OEM7500, OEM7600, OEM7700, OEM7720, PwrPak7, SPAN CPT7, SMART7, SMART2

This log contains pseudorange measurement noise statistics are translated in the position domain in order to give statistical measures of the quality of the position solution.

This log reflects the accuracy of the solution type used in the **BESTPOS** log (see page 371) and **GPGGA** log (see page 444), except for the RMS field. The RMS field, since it specifically relates to pseudorange inputs, does not represent carrier-phase based positions. Instead, it reflects the accuracy of the pseudorange position which is given in the **PSRPOS** log (see page 585).

The GPGST log outputs these messages without waiting for a valid almanac. Instead, it uses a UTC time, calculated with default parameters. In this case, the UTC time status (see the **TIME** log on page 783) is set to WARNING since it may not be one hundred percent accurate. When a valid almanac is available, the receiver uses the real parameters. Then the UTC time status is set to VALID.



If the **NMEATALKER** command (see page 196) is set to AUTO, the talker (the first 2 characters after the \$ sign in the log header) is set to GP (GPS satellites only), GL (GLONASS satellites only) or GN (satellites from both systems) or GA (Galileo satellites only).

Message ID: 222

Log Type: Synch

Recommended Input:

```
log gpgst ontime 1
```

Example 1 (GPS only):

```
$GPGST,141451.00,1.18,0.00,0.00,0.0000,0.00,0.00,0.00*6B
```

Example 2 (Combined GPS and GLONASS):

```
$GNGST,143333.00,7.38,1.49,1.30,68.1409,1.47,1.33,2.07*4A
```



1. See the Note in the **GPGGA** log (see page 444) that applies to all NMEA logs.
2. Accuracy is based on statistics, reliability is measured in percent. When a receiver can measure height to one meter, this is an accuracy. Usually this is a one sigma value (one SD). A one sigma value for height has a reliability of 68%, that is, the error is less than one meter 68% of the time. For a more realistic accuracy, double the one sigma value (1 m) and the result is 95% reliability (error is less than 2 m 95% of the time). Generally, GNSS heights are 1.5 times poorer than horizontal positions.

As examples of statistics, the GPGST message and NovAtel performance specifications use Root Mean Square (RMS). Specifications may be quoted in CEP:

- RMS - root mean square (a probability level of 68%)
- CEP - circular error probable (the radius of a circle such that 50% of a set of events occur inside the boundary)

Field	Structure	Description	Symbol	Example
1	\$GPGST	Log header. See <i>Messages</i> on page 27 for more information.		\$GPGST
2	utc	UTC time status of position (hours/minutes/seconds/ decimal seconds)	hhmmss.ss	173653.00
3	rms	RMS value of the standard deviation of the range inputs to the navigation process. Range inputs include pseudoranges and DGPS corrections	x.x	2.73
4	smjr std	Standard deviation of semi-major axis of error ellipse (m)	x.x	2.55
5	smnr std	Standard deviation of semi-minor axis of error ellipse (m)	x.x	1.88
6	orient	Orientation of semi-major axis of error ellipse (degrees from true north)	x.x	15.2525
7	lat std	Standard deviation of latitude error (m)	x.x	2.51
8	lon std	Standard deviation of longitude error (m)	x.x	1.94
9	alt std	Standard deviation of altitude error (m)	x.x	4.30
10	*xx	Check sum	*hh	*6E
11	[CR][LF]	Sentence terminator		[CR][LF]

3.50 GPGSV

GPS satellites in view

Platform: OEM719, OEM729, OEM7500, OEM7600, OEM7700, OEM7720, PwrPak7, SPAN CPT7, SMART7, SMART2

This log contains the number of GPS SVs in view, PRN numbers, elevation, azimuth and SNR value. Each message includes up to four satellites. If there are more than four satellites in view, additional messages are transmitted. The total number of messages and the message number are included in each message.

The GPGSV log outputs these messages without waiting for a valid almanac. Instead, it uses a UTC time, calculated with default parameters. In this case, the UTC time status (see the **TIME** log on page 783) is set to WARNING since it may not be one hundred percent accurate. When a valid almanac is available, the receiver uses the real parameters. Then the UTC time status is set to VALID.



1. Satellite information may require the transmission of multiple messages. The first field specifies the total number of messages, minimum value 1. The second field identifies the order of this message (message number), minimum value 1.
2. If the **NMEATALKER** command (see page 196) is set to AUTO, the talker (the first 2 characters after the \$ sign in the log header) is set to GP (GPS satellites only) or GL (GLONASS satellites only) or GN (satellites from both systems) or GA (Galileo satellites only). Each system is output in a separate message.
3. The ID setting in the **NMEATALKER** command (see page 196) controls the satellites reported in this log. If the NMEATALKER ID is set to GP, only GPS satellites are reported in this log. If the NMEATALKER ID is set to AUTO, all satellites in view are reported.
4. A variable number of 'PRN-Elevation-Azimuth-SNR' sets are allowed up to a maximum of four sets per message. Null fields are not required for unused sets when less than four sets are transmitted.

Message ID: 223

Log Type: Synch

Recommended Input:

```
log gpgsv ontime 1
```

Example (Including GPS and GLONASS sentences):

```
$GPGSV,3,1,11,18,87,050,48,22,56,250,49,21,55,122,49,03,40,284,47*78
```

```
$GPGSV,3,2,11,19,25,314,42,26,24,044,42,24,16,118,43,29,15,039,42*7E
```

```
$GPGSV,3,3,11,09,15,107,44,14,11,196,41,07,03,173,*4D
```

```
$GLGSV,2,1,06,65,64,037,41,66,53,269,43,88,39,200,44,74,25,051,*64
```

```
$GLGSV,2,2,06,72,16,063,35,67,01,253,*66
```



The GPGSV log can be used to determine which GPS satellites are currently available to the receiver. Comparing the information from this log to that in the GPGSA log shows if the receiver is tracking all available satellites.



See also the Note in the **GPGGA** log (see page 444) that applies to all NMEA logs.

Field	Structure	Description	Symbol	Example
1	\$GPGSV	Log header. See <i>Messages</i> on page 27 for more information.		\$GPGSV
2	# msgs	Total number of messages (1-9)	x	3
3	msg #	Message number (1-9)	x	1
4	# sats	Total number of satellites in view. May be different than the number of satellites in use (see also the GPGGA log on page 444)	xx	09
5	prn	Satellite PRN number GPS = 1 to 32 SBAS = 33 to 64 (add 87 for PRN#s) GLO = 65 to 96 ¹	xx	03
6	elev	Elevation, degrees, 90 maximum	xx	51
7	azimuth	Azimuth, degrees True, 000 to 359	xxx	140
8	SNR	SNR (C/No) 00-99 dB, null when not tracking	xx	42
...	...	Next satellite PRN number, elev, azimuth, SNR,		
...		
...	...	Last satellite PRN number, elev, azimuth, SNR,		
variable	*xx	Check sum	*hh	*72
variable	[CR][LF]	Sentence terminator		[CR][LF]

¹The NMEA GLONASS PRN numbers are 64 plus the GLONASS slot number. Current slot numbers are 1 to 24 which give the range 65 to 88. PRN numbers 89 to 96 are available if slot numbers above 24 are allocated to on-orbit spares.

3.51 GPHDT

NMEA heading log

Platform: OEM719, OEM729, OEM7500, OEM7600, OEM7700, OEM7720, PwrPak7, SPAN CPT7, SMART7

This log contains actual vessel heading in degrees True (from True North). See also a description of heading in the **HEADING2** log on page 469. You can also set a standard deviation threshold for this log, see the **HDTOUTTHRESHOLD** command on page 144.



You must have an ALIGN capable receiver to use this log.



The GPHDT log can only be logged using the ONCHANGED trigger. Other triggers, such as ONTIME are not accepted.



If the **NMEATALKER** command (see page 196) is set to AUTO, the talker (the first 2 characters after the \$ sign in the log header) is set to GP (GPS satellites only), GL (GLONASS satellites only) or GN (satellites from both systems) or GA (Galileo satellites only).

Message ID: 1045

Log Type: Asynch

Recommended Input:

```
log gphdt onchanged
```

Example 1 (GPS only):

```
$GPHDT,75.5664,T*36
```

Example 2 (Combined GPS and GLONASS):

```
$GNHDT,75.5554,T*45
```

Field	Structure	Description	Symbol	Example
1	\$GPHDT	Log header. See <i>Messages</i> on page 27 for more information.		\$GPHDT
2	heading	Heading in degrees	x.x	75.5554
3	True	Degrees True	T	T
4	*xx	Check sum	*hh	*36
5	[CR][LF]	Sentence terminator		[CR][LF]

3.52 GPRMC

GPS specific information

Platform: OEM719, OEM729, OEM7500, OEM7600, OEM7700, OEM7720, PwrPak7, SPAN CPT7, SMART7, SMART2

This log contains time, date, position, track made good and speed data provided by the GPS navigation receiver. RMC and RMB are the recommended minimum navigation data to be provided by a GNSS receiver.

A comparison of the position precision between this log and other selected NMEA logs can be seen in *Table 87: Position Precision of NMEA Logs* on page 450.

The GPRMC log outputs these messages without waiting for a valid almanac. Instead, it uses a UTC time, calculated with default parameters. In this case, the UTC time status (see the **TIME** log on page 783) is set to WARNING since it may not be one hundred percent accurate. When a valid almanac is available, the receiver uses the real parameters. Then the UTC time status is set to VALID.



If the **NMEATALKER** command (see page 196) is set to AUTO, the talker (the first 2 characters after the \$ sign in the log header) is set to GP (GPS satellites only), GL (GLONASS satellites only) or GN (satellites from both systems) or GA (Galileo satellites only).



The position for the **GPRMC** log is reported in the user selected datum. See the **DATUM** command on page 100 for more details.

Message ID: 225

Log Type: Synch

Recommended Input:

```
log gprmc ontime 1
```

Example 1 (GPS):

```
$GPRMC,144326.00,A,5107.0017737,N,11402.3291611,W,0.080,323.3,210307,0.0,E,A*20
```

Example 2 (Combined GPS and GLONASS):

```
$GNRMC,143909.00,A,5107.0020216,N,11402.3294835,W,0.036,348.3,210307,0.0,E,A*31
```



See the Note in the **GPGGA** log (see page 444) that applies to all NMEA logs.

Field	Structure	Field Description	Symbol	Example
1	\$GPRMC	Log header. See <i>Messages</i> on page 27 for more information.		\$GPRMC

Field	Structure	Field Description	Symbol	Example
2	utc	UTC of position	hhmmss.ss	144326.00
3	pos status	Position status (A = data valid, V = data invalid)	A	A
4	lat	Latitude (DDmm.mm)	llll.ll	5107.0017737
5	lat dir	Latitude direction: (N = North, S = South)	a	N
6	lon	Longitude (DDDmm.mm)	yyyyy.yy	11402.3291611
7	lon dir	Longitude direction: (E = East, W = West)	a	W
8	speed Kn	Speed over ground, knots	x.x	0.080
9	track true	Track made good, degrees True	x.x	323.3
10	date	Date: dd/mm/yy	xxxxxx	210307
11	mag var	Magnetic variation, degrees Note that this field is the actual magnetic variation and will always be positive. The direction of the magnetic variation is always positive.	x.x	0.0
12	var dir	Magnetic variation direction E/W Easterly variation (E) subtracts from True course. Westerly variation (W) adds to True course.	a	E
13	mode ind	Positioning system mode indicator, see <i>Table 89: NMEA Positioning System Mode Indicator</i> below	a	A
14	*xx	Check sum	*hh	*20
15	[CR][LF]	Sentence terminator		[CR][LF]

Table 89: NMEA Positioning System Mode Indicator

Mode	Indicator
A	Autonomous
D	Differential
E	Estimated (dead reckoning) mode
M	Manual input
N	Data not valid

3.53 GPSEPHEM

Decoded GPS L1 C/A ephemerides

Platform: OEM719, OEM729, OEM7500, OEM7600, OEM7700, OEM7720, PwrPak7, SPAN CPT7, SMART7, SMART2

This log contains a single set of GPS ephemeris parameters.

Message ID: 7

Log Type: Asynch

Recommended Input:

log gpsephema onchanged

ASCII Example:

```
#GPSEPHEMA, COM1, 12, 59.0, SATTIME, 1337, 397560.000, 02000000, 9145, 1984; 3, 397560.0,
0, 99, 99, 1337, 1337, 403184.0, 2.656004220e+07, 4.971635660e-09, -2.752651501e+00,
7.1111434372e-03, 6.0071892571e-01, 2.428889275e-06, 1.024827361e-05,
1.64250000e+02, 4.81562500e+01, 1.117587090e-08, -7.078051567e-08,
9.2668266314e-01, -1.385772009e-10, -2.098534041e+00, -8.08319384e-09, 99, 403184.0,
-4.190951586e-09, 2.88095e-05, 3.06954e-12, 0.00000, TRUE, 1.458614684e-04,
4.00000000e+00*0f875b12

#GPSEPHEMA, COM1, 11, 59.0, SATTIME, 1337, 397560.000, 02000000, 9145, 1984; 25, 397560.0,
0, 184, 184, 1337, 1337, 403200.0, 2.656128681e+07, 4.897346851e-09, 1.905797220e+00,
1.1981436634e-02, -1.440195331e+00, -1.084059477e-06, 6.748363376e-06,
2.37812500e+02, -1.74687500e+01, 1.825392246e-07, -1.210719347e-07,
9.5008501632e-01, 2.171519024e-10, 2.086083072e+00, -8.06140722e-09, 184, 403200.0,
-7.450580597e-09, 1.01652e-04, 9.09495e-13, 0.00000, TRUE, 1.458511425e-04,
4.00000000e+00*18080b24

...

#GPSEPHEMA, COM1, 0, 59.0, SATTIME, 1337, 397560.000, 02000000, 9145, 1984; 1, 397560.0, 0,
224, 224, 1337, 1337, 403200.0, 2.656022490e+07, 3.881233098e-09, 2.938005195e+00,
5.8911956148e-03, -1.716723741e+00, -2.723187208e-06, 9.417533875e-06,
2.08687500e+02, -5.25625000e+01, 9.126961231e-08, -7.636845112e-08,
9.8482911735e-01, 1.325055194e-10, 1.162012787e+00, -7.64138972e-09, 480, 403200.0,
-3.259629011e-09, 5.06872e-06, 2.04636e-12, 0.00000, TRUE, 1.458588731e-04,
4.00000000e+00*97058299
```



The GPSEPHEM log can be used to monitor changes in the orbits of GPS satellites.



To obtain copies of IS-GPS-200, refer to the GPS website (<https://www.gps.gov/technical/icwg/>).

Field	Field type	Description	Format	Binary Bytes	Binary Offset
1	GPSEPHM header	Log header. See <i>Messages</i> on page 27 for more information.		H	0
2	PRN	Satellite PRN number	Ulong	4	H
3	tow	Time stamp of subframe 1 (s)	Double	8	H+4
4	health	Health status - a 6-bit health code as defined in IS-GPS-200	Ulong	4	H+12
5	IODE1	Issue of ephemeris data 1	Ulong	4	H+16
6	IODE2	Issue of ephemeris data 2	Ulong	4	H+20
7	week	toe week number (computed from Z count week)	Ulong	4	H+24
8	z week	Z count week number. This is the week number from subframe 1 of the ephemeris. The 'toe week' (field #7) is derived from this to account for rollover	Ulong	4	H+28
9	toe	Reference time for ephemeris (s)	Double	8	H+32
10	A	Semi-major axis (m)	Double	8	H+40
11	ΔN	Mean motion difference (radians/s)	Double	8	H+48
12	M_0	Mean anomaly of reference time (radians)	Double	8	H+56
13	ecc	Eccentricity, dimensionless	Double	8	H+64
14	ω	Argument of perigee (radians)	Double	8	H+72
15	cuc	Amplitude of cosine harmonic correction term to the argument of latitude (radians)	Double	8	H+80
16	cus	Amplitude of sine harmonic correction term to the argument of latitude (radians)	Double	8	H+88
17	crc	Amplitude of cosine harmonic correction term to the orbit radius (m)	Double	8	H+96
18	crs	Amplitude of sine harmonic correction term to the orbit radius (m)	Double	8	H+104
19	cic	Amplitude of cosine harmonic correction term to the angle of inclination (radians)	Double	8	H+112
20	cis	Amplitude of sine harmonic correction term to the angle of inclination (radians)	Double	8	H+120
21	I_0	Inclination angle at reference time (radians)	Double	8	H+128

Field	Field type	Description	Format	Binary Bytes	Binary Offset
22	I^0	Rate of inclination angle (radians/s)	Double	8	H+136
23	ω_0	Right ascension (radians)	Double	8	H+144
24	$\dot{\omega}$	Rate of right ascension (radians/s)	Double	8	H+152
25	iodc	Issue of data clock	Ulong	4	H+160
26	toc	SV clock correction term (s)	Double	8	H+164
27	tgdc	Estimated group delay difference (s)	Double	8	H+172
28	a_{f0}	Clock aging parameter (s)	Double	8	H+180
29	a_{f1}	Clock aging parameter (s/s)	Double	8	H+188
30	a_{f2}	Clock aging parameter (s/s/s)	Double	8	H+196
31	AS	Anti-spoofing on: 0 = FALSE 1 = TRUE	Bool	4	H+204
32	N	Corrected mean motion (radians/s)  This field is computed by the receiver.	Double	8	H+208
33	URA	User Range Accuracy variance (m) ² The ICD specifies that the URA index transmitted in the ephemerides can be converted to a nominal standard deviation value using an algorithm listed there. We publish the square of the nominal value (variance). The correspondence between the original URA index and the value output is shown in <i>Table 90: URA Variance</i> below	Double	8	H+216
34	xxxx	32-bit CRC (ASCII and Binary only)	Ulong	4	H+224
35	[CR][LF]	Sentence terminator (ASCII only)	-	-	-

Table 90: URA Variance

Index Value (m)	A: Standard Deviations (m)	Variance: A ² (m ²)
0	2.0	4
1	2.8	7.84

Index Value (m)	A: Standard Deviations (m)	Variance: A² (m²)
2	4.0	16
3	5.7	32.49
4	8	64
5	11.3	127.69
6	16.0	256
7	32.0	1024
8	64.0	4096
9	128.0	16384
10	256.0	65536
11	512.0	262144
12	1024.0	1048576
13	2048.0	4194304
14	4096.0	16777216
15	8192.0	67108864

3.54 GPVTG

Track made good and ground speed

Platform: OEM719, OEM729, OEM7500, OEM7600, OEM7700, OEM7720, PwrPak7, SPAN CPT7, SMART7, SMART2

This log contains the track made good and speed relative to the ground.

The GPVTG log outputs these messages without waiting for a valid almanac. Instead, it uses a UTC time, calculated with default parameters. In this case, the UTC time status (see the **TIME** log on page 783) is set to WARNING since it may not be one hundred percent accurate. When a valid almanac is available, the receiver uses the real parameters. Then the UTC time status is set to VALID.

Message ID: 226

Log Type: Synch

Recommended Input:

```
log gpvtg ontime 1
```

Example 1 (GPS only):

```
$GPVTG,172.516,T,155.295,M,0.049,N,0.090,K,D*2B
```

Example 2 (Combined GPS and GLONASS):

```
$GNVTG,134.395,T,134.395,M,0.019,N,0.035,K,A*33
```



If the **NMEATALKER** command (see page 196) is set to AUTO, the talker (the first 2 characters after the \$ sign in the log header) is set to GP (GPS satellites only), GL (GLONASS satellites only) or GN (satellites from both systems).



See the Note in the **GPGGA** log (see page 444) that applies to all NMEA logs.

Field	Structure	Description	Symbol	Example
1	\$GPVTG	Log header. See <i>Messages</i> on page 27 for more information.		\$GPVTG
2	track true	Track made good, degrees True	x.x	24.168
3	T	True track indicator	T	T
4	track mag	Track made good, degrees Magnetic; Track mag = Track true + (MAGVAR correction) See the MAGVAR command on page 185	x.x	24.168
5	M	Magnetic track indicator	M	M

Field	Structure	Description	Symbol	Example
6	speed Kn	Speed over ground, knots	x.x	0.4220347
7	N	Nautical speed indicator (N = Knots)	N	N
8	speed Km	Speed, kilometers/hour	x.x	0.781608
9	K	Speed indicator (K = km/hr)	K	K
10	mode ind	Positioning system mode indicator, see <i>Table 91: NMEA Positioning System Mode Indicator</i> below	a	A
11	*xx	Check sum	*hh	*7A
12	[CR][LF]	Sentence terminator		[CR][LF]

Table 91: NMEA Positioning System Mode Indicator

Mode	Indicator
A	Autonomous
D	Differential
E	Estimated (dead reckoning) mode
M	Manual input
N	Data not valid

3.55 GPZDA

UTC time and date

Platform: OEM719, OEM729, OEM7500, OEM7600, OEM7700, OEM7720, PwrPak7, SPAN CPT7, SMART7, SMART2

The GPZDA log outputs the UTC date and time. If no valid almanac is stored in the receiver, a default UTC offset is used to generate the time until a new almanac is downloaded. If the offset is not up-to-date, this initial UTC time may be incorrect until the new almanac is present.

Message ID: 227

Log Type: Synch

Recommended Input:

```
log gpzda ontime 1
```

Example:

```
$GPZDA,143042.00,25,08,2005,,*6E
```



See the Note in the **GPGGA** log (see page 444) that applies to all NMEA logs.

Field	Structure	Description	Symbol	Example
1	\$GPZDA	Log header. See <i>Messages</i> on page 27 for more information.		\$GPZDA
2	utc	UTC time status	hhmmss.ss	220238.00
3	day	Day, 01 to 31	xx	15
4	month	Month, 01 to 12	xx	07
5	year	Year	xxxx	1992
6	null	Local zone description—not available <div style="border: 1px solid black; padding: 5px; margin: 5px 0;"> Local time zones are not supported by OEM7 family receivers. Fields 6 and 7 are always null. </div>	xx	(empty when no data is present)
7	null	Local zone minutes description—not available	xx	(empty when no data is present)
8	*xx	Check sum	*hh	*6F
9	[CR][LF]	Sentence terminator		[CR][LF]

3.56 HEADING2

Heading information with multiple rovers

Platform: OEM719, OEM729, OEM7500, OEM7600, OEM7700, OEM7720, PwrPak7, SPAN CPT7, SMART7, SMART2

The heading is the angle from True North of the base to rover vector in a clockwise direction. This log can be output at both Master and Rover ends.



An ALIGN capable receiver is required to use this log.



Asynchronous logs, such as HEADING2, should only be logged ONCHANGED or ONNEW otherwise the most current data is not available or included in the output. An example of this occurrence is in the ONTIME trigger. If this trigger is not logged ONNEW or ONCHANGED, it may cause inaccurate time tags.

The HEADING2 log is dictated by the output frequency of the master receiver sending out RTCAOBS2, RTCAOBS3 or NOVATELXOBS messages. HEADING2 supports 20 Hz output rate. Ensure sufficient radio bandwidth is available between the ALIGN Master and the ALIGN Rover.

Message ID: 1335

Log Type: Asynch

Recommended Input:

```
log heading2a onnew
```

ASCII Example:

```
#HEADING2A,COM1,0,39.5,FINESTEERING,1622,422892.200,02040000,f9bf,6521;
SOL_COMPUTED,NARROW_INT,0.927607417,178.347869873,-1.3037414550.0,0.261901051,
0.391376048,"R222","AAAA",18,17,17,16,0,01,0,33*7be836f6
```

Field	Field type	Description	Binary Format	Binary Bytes	Binary Offset
1	HEADING2 header	Log header. See <i>Messages</i> on page 27 for more information.		H	0
2	sol stat	Solution status, see <i>Table 65: Solution Status</i> on page 374	Enum	4	H
3	pos type	Position type, see <i>Table 66: Position or Velocity Type</i> on page 375	Enum	4	H+4

Field	Field type	Description	Binary Format	Binary Bytes	Binary Offset
4	length	<p>Baseline length in meters</p> <p>For ALIGN Heading models with position access, this field is -1.</p> <p>For ALIGN Heading models without position access, this field is only the decimal portion of the baseline in meters.</p> <p>For ALIGN Relative Positioning models receiving corrections from a master with a fixed position, this field is -1.</p> <p>For ALIGN Relative Positioning models receiving corrections from a master in moving baseline mode, this field is the complete baseline length in meters.</p>	Float	4	H+8
5	heading	Heading in degrees (0° to 359.999°)	Float	4	H+12
6	pitch	Pitch (±90 degrees)	Float	4	H+16
7	Reserved		Float	4	H+20
8	hdg std dev	Heading standard deviation in degrees	Float	4	H+24
9	ptch std dev	Pitch standard deviation in degrees	Float	4	H+28
10	rover stn ID	<p>Rover Receiver ID</p> <p>Set using the SETROVERID command (see page 287) on the Rover</p> <p>e.g. setroverid RRRR</p>	Char[4]	4	H+32
11	Master stn ID	<p>Master Receiver ID</p> <p>Set using the DGPSTXID command (see page 105) on the Master</p> <p>Default: AAAA</p>	Char[4]	4	H+36
12	#SVs	Number of satellites tracked	Uchar	1	H+40
13	#solnSVs	Number of satellites in solution	Uchar	1	H+41
14	#obs	Number of satellites above the elevation mask angle	Uchar	1	H+42
15	#multi	Number of satellites above the mask angle with L2	Uchar	1	H+43

Field	Field type	Description	Binary Format	Binary Bytes	Binary Offset
16	sol source	Solution source (see <i>Table 92: Solution Source</i> below)	Hex	1	H+44
17	ext sol stat	Extended solution status (see <i>Table 69: Extended Solution Status</i> on page 378)	Uchar	1	H+45
18	Galileo and BeiDou sig mask	Galileo and BeiDou signals used mask (see <i>Table 68: Galileo and BeiDou Signal-Used Mask</i> on page 378)	Hex	1	H+46
19	GPS and GLONASS sig mask	GPS and GLONASS signals used mask (see <i>Table 67: GPS and GLONASS Signal-Used Mask</i> on page 377)	Hex	1	H+47
20	xxxx	32-bit CRC (ASCII and Binary only)	Hex	4	H+48
21	[CR][LF]	Sentence terminator (ASCII only)	-	-	-

Table 92: Solution Source

Bit	Mask	Description
0-1	0x03	Reserved
2-3	0x0C	Source antenna 0 = Primary antenna 1 = Secondary antenna
4-7	0xF0	Reserved

3.57 HEADINGEXT

Extended heading log

Platform: OEM719, OEM729, OEM7500, OEM7600, OEM7700, OEM7720, PwrPak7, SPAN CPT7, SMART7

HEADINGEXT is a proprietary message sent from the rover receiver to the master receiver in an ALIGN or Relative INS configuration. This message provides the position information from the rover receiver that the master receiver requires to produce an ALIGN or Relative INS solution.

Message ID: 1132

Log Type: Asynch

Recommended Input:

```
log com2 headingextb onnew
```

3.58 HEADINGEXT2

Extended heading log in variable array form

Platform: OEM719, OEM729, OEM7500, OEM7600, OEM7700, OEM7720, PwrPak7, SPAN CPT7, SMART7

HEADINGEXT2 is a proprietary message sent from the rover receiver to the master receiver in an ALIGN or Relative INS configuration. This message provides the position information from the rover receiver that the master receiver requires to produce an ALIGN or Relative INS solution.

Message ID: 1661

Log Type: Asynch

Recommended Input:

```
log com2 headingext2b onnew
```

3.59 HEADINGRATE

Heading rate information

Platform: OEM719, OEM729, OEM7500, OEM7600, OEM7700, OEM7720, PwrPak7, SPAN CPT7, SMART7

This log provides rate of change for the heading parameters. The heading is the angle from True North of the base to rover vector in a clockwise direction.



You must have an ALIGN capable receiver to use this log.

Message ID: 1698

Log Type: Asynch

Recommended Input:

log headingratea onchanged

ASCII Example:

```
#HEADINGRATEA, UNKNOWN, 0, 60.0, FINESTEERING, 1873, 411044.700, 02040008, c53a, 32768;
SOL_COMPUTED, NARROW_INT, 0.025000000, 0.000000000, -0.308837891, 0.575313330,
0.000000000, 1.264251590, 1.663657904, 0.0, "748M", "725U", 00, 0, 0, 0*66f97b96
```

Field	Field type	Description	Format	Binary Bytes	Binary Offset
1	HEADINGRATE header	Log header. See <i>Messages</i> on page 27 for more information.		H	0
2	sol stat	Solution status, see <i>Table 65: Solution Status</i> on page 374	Enum	4	H
3	pos type	Position type, see <i>Table 66: Position or Velocity Type</i> on page 375	Enum	4	H+4
4	latency	A measure of the latency in the velocity time tag in seconds. It should be subtracted from the time to give improved results.	Float	4	H+8
5	length rate	Rate of change of the baseline length in m/s. For Z ALIGN rovers, this field outputs the decimal portion of the baseline rate.	Float	4	H+12
6	heading rate	Rate of change of the heading in degrees/s	Float	4	H+16
7	pitch rate	Rate of change of the pitch in degrees/s	Float	4	H+20
8	length rate std dev	Baseline rate standard deviation in m/s	Float	4	H+24
9	heading rate std dev	Heading rate standard deviation in degrees/s	Float	4	H+28

Field	Field type	Description	Format	Binary Bytes	Binary Offset
10	pitch rate std dev	Pitch rate standard deviation in degrees/s	Float	4	H+32
11	Reserved		Float	4	H+36
12	rover stn ID	Rover Receiver ID Set using the SETROVERID command (see page 287) on the Rover receiver. For example, setroverid RRRR.	Uchar	4	H+40
13	master stn ID	Master Receiver ID Set using the DGPSTXID command (see page 105) on the Master receiver. Default: AAAA	Uchar	4	H+44
14	sol source	Solution source (see <i>Table 92: Solution Source</i> on page 471)	Hex	1	H+48
15	Reserved		Uchar	1	H+49
16	Reserved		Uchar	1	H+50
17	Reserved		Uchar	1	H+51
18	xxxx	32-bit CRC (ASCII and Binary only)	Hex	4	H+52
19	[CR][LF]	Sentence terminator (ASCII only)	-	-	-

3.60 HEADINGSATS

Satellite used in heading solution

Platform: OEM719, OEM729, OEM7500, OEM7600, OEM7700, OEM7720, PwrPak7, SPAN CPT7, SMART7

This log provides information on the satellites that are used in a heading solution.



The HEADINGSATS log can only be used from the ALIGN rover.

Message ID: 1316

Log Type: Asynch

Recommended Input:

```
log headingsatsa onnew
```

ASCII Example:

```
#HEADINGSATSA, COM1, 0, 26.0, FINESTEERING, 1625, 344654.600, 02000008, f5b0, 6569;17,
GPS, 31, GOOD, 00000003, GPS, 23, GOOD, 00000003, GPS, 30, GOOD, 00000003, GPS, 16, GOOD,
00000003, GPS, 20, GOOD, 00000003, GPS, 25, GOOD, 00000003, GPS, 4, GOOD, 00000003, GPS, 24,
GOOD, 00000003, GPS, 11, GOOD, 00000003, GPS, 32, GOOD, 00000003, GPS, 14, GOOD, 00000003,
GLONASS, 20+2, GOOD, 00000003, GLONASS, 14-7, GOOD, 00000001, GLONASS, 2-4, GOOD,
00000003, GLONASS, 13-2, GOOD, 00000003, GLONASS, 12-1, GOOD, 00000003, GLONASS, 19+3,
GOOD, 00000001*15ec53a6
```

Field	Field type	Description	Format	Binary Bytes	Binary Offset
1	HEADINGSATS	Log header. See <i>Messages</i> on page 27 for more information.		H	0
2	#entries	Number of records to follow	Ulong	4	H
3	System	Refer to <i>Table 93: Satellite System</i> on the next page.	Enum	4	H+4

Field	Field type	Description	Format	Binary Bytes	Binary Offset
4	Satellite ID	In binary logs, the satellite ID field is 4 bytes. The 2 lowest-order bytes, interpreted as a USHORT, are the system identifier: for instance, the PRN for GPS, or the slot for GLONASS. The 2 highest-order bytes are the frequency channel for GLONASS, interpreted as a SHORT and zero for all other systems. In ASCII and abbreviated ASCII logs, the satellite ID field is the system identifier. If the system is GLONASS and the frequency channel is not zero, then the signed channel is appended to the system identifier. For example, slot 13, frequency channel -2 is output as 13-2	Ulong	4	H+8
5	Status	see <i>Table 71: Observation Statuses</i> on page 381	Enum	4	H+12
6	Signal Mask	see <i>Table 72: BESTSATS GPS Signal Mask</i> on page 382, <i>Table 73: BESTSATS GLONASS Signal Mask</i> on page 383, <i>Table 74: BESTSATS Galileo Signal Mask</i> on page 383, <i>Table 75: BESTSATS BeiDou Signal Mask</i> on page 383	Hex	4	H+16
7	Next satellite offset = H + 4 + (#sat x 16)				
8	xxxx	32-bit CRC (ASCII and Binary only)	Hex	4	H+4+ (#satx16)
9	[CR][LF]	Sentence Terminator (ASCII only)	-	-	-

Table 93: Satellite System

Binary Value	ASCII Mode Name
0	GPS
1	GLONASS
2	SBAS
5	Galileo
6	BeiDou

Binary Value	ASCII Mode Name
7	QZSS
9	NAVIC

3.61 HWMONITOR

Monitor hardware levels

Platform: OEM719, OEM729, OEM7500, OEM7600, OEM7700, OEM7720, PwrPak7, SPAN CPT7, SMART7, SMART2

This log allows the user to monitor temperature, antenna current and voltages.

Message ID: 963

Log Type: Polled

Recommended Input:

```
log hwmonitora ontime 10
```

ASCII Example:

```
#HWMONITORA,COM1,0,90.5,FINESTEERING,1928,153778.000,02000020,52db,32768;
7,43.284492493,100,0.000000000,200,5.094994068,700,1.195970654,800,3.279609442,
f00,1.811965823,1100,44.017093658,1600*52beac4b
```

Field	Field Type	Description	Format	Binary Bytes	Binary Offset
1	HWMONITOR header	Log header. See <i>Messages</i> on page 27 for more information.		H	0
2	# measurements	Number of measurements to follow	Ulong	4	H
3	reading	Temperature, antenna current or voltage reading Units: <ul style="list-style-type: none"> • Degree Celsius for Temperature • Amps for Antenna Current • Volts for Voltage 	Float	4	H+4
4	status	See <i>Table 94: HWMONITOR Status Table</i> on the next page	HexUlong	4	H+8
5...	Next reading offset = H + 4 + (# measurements x 8)				
6	xxxx	32-bit CRC (ASCII and Binary only)	Hex	4	H+4+ (# measurements x 8)
7	[CR][LF]	Sentence Terminator (ASCII only)	-	-	-

Table 94: HWMONITOR Status Table

Bits	Description	Applicable Platforms
0-7	Boundary Limit Status (Hex): 0x00 = Value falls within acceptable bounds 0x01 = Value is under the lower warning limit 0x02 = Value is under the lower error limit 0x03 = Value is over the upper warning limit 0x04 = Value is over the upper error limit	
8-15	Reading Type (Hex):	
	0x00 = Reserved	
	0x01 = Temperature A temperature sensor is located on the receiver and provides the approximate temperature of the PCB surface near critical components (for example, CPU, TCXO) (degrees Celsius)	All
	0x02 = Antenna Current The amount of current being drawn by the active antenna (mA)	All except OEM7500
	0x06 = Digital Core 3V3 Voltage Internal regulator output voltage supplying a key component on the receivers (Volts) 0x06 = 3.3V Supply Voltage (Volts)	All except OEM7720 OEM7720
	0x07 = Antenna Voltage	All except OEM7500
	0x08 = Digital 1V2 Core Voltage Internal regulator output voltage supplying a key component on the receiver (Volts)	All
	0x0F = Regulated Supply Voltage Internal regulator output voltage supplying a key component on the receiver (Volts) 0x0F = Supply Voltage Voltage applied to Pins 1 and 2 of the main connector	All except OEM7720 OEM7720
	0x11 = 1V8	All
	0x16 = Secondary Temperature A second temperature sensor is located on the receiver PCB (degrees Celsius)	All except OEM7500

Bits	Description	Applicable Platforms
	0x17 = Peripheral Core Voltage	All except OEM7500
	0x18 = Secondary Antenna Current	OEM7720, PwrPak7D, PwrPak7D-E1, PwrPak7D-E2, SPAN CPT7
	0x19 = Secondary Antenna Voltage	OEM7720, PwrPak7D, PwrPak7D-E1, PwrPak7D-E2, SPAN CPT7

3.62 IONUTC

Ionospheric and UTC data

Platform: OEM719, OEM729, OEM7500, OEM7600, OEM7700, OEM7720, PwrPak7, SPAN CPT7, SMART7, SMART2

This log contains the Ionospheric Model parameters (ION) and the Universal Time Coordinated parameters (UTC).

Message ID: 8

Log Type: Asynch

Recommended Input:

```
log ionutca onchanged
```

ASCII Example:

```
#IONUTCA, COM1, 0, 58.5, FINESTEERING, 1337, 397740.107, 02000000, ec21, 1984;  
1.210719347000122e-08, 2.235174179077148e-08, -5.960464477539062e-08,  
-1.192092895507812e-07, 1.003520000000000e+05, 1.146880000000000e+05,  
-6.553600000000000e+04, -3.276800000000000e+05, 1337, 589824,  
-1.2107193470001221e-08, -3.907985047e-14, 1355, 7, 13, 14, 0*c1dfd456
```



The Receiver-Independent Exchange (RINEX¹) format is a broadly accepted, receiver independent format for storing GPS data. It features a non-proprietary ASCII file format that can be used to combine or process data generated by receivers made by different manufacturers.

Use the NovAtel's Convert utility to produce RINEX files from NovAtel receiver data files.

Field	Field type	Description	Format	Binary Bytes	Binary Offset
1	IONUTC header	Log header. See <i>Messages</i> on page 27 for more information.		H	0
2	a0	Alpha parameter constant term	Double	8	H
3	a1	Alpha parameter 1st order term	Double	8	H+8
4	a2	Alpha parameter 2nd order term	Double	8	H+16
5	a3	Alpha parameter 3rd order term	Double	8	H+24
6	b0	Beta parameter constant term	Double	8	H+32
7	b1	Beta parameter 1st order term	Double	8	H+40
8	b2	Beta parameter 2nd order term	Double	8	H+48

¹Refer to the U.S. National Geodetic Survey website at: www.ngs.noaa.gov/CORS/data.shtml.

Field	Field type	Description	Format	Binary Bytes	Binary Offset
9	b3	Beta parameter 3rd order term	Double	8	H+56
10	utc wn	UTC reference week number	Ulong	4	H+64
11	tot	Reference time of UTC parameters (s)	Ulong	4	H+68
12	A0	UTC constant term of polynomial (s)	Double	8	H+72
13	A1	UTC 1st order term of polynomial (s)	Double	8	H+80
14	wn lsf	Future week number	Ulong	4	H+88
15	dn	Day number (the range is 1 to 7 where Sunday = 1 and Saturday = 7)	Ulong	4	H+92
16	deltat ls	Delta time due to leap seconds	Long	4	H+96
17	deltat lsf	Future delta time due to leap seconds	Long	4	H+100
18	Reserved			4	H+104
19	xxxx	32-bit CRC (ASCII and Binary only)	Hex	4	H+108
20	[CR][LF]	Sentence terminator (ASCII only)	-	-	-

3.63 IPSTATS

IP statistics

Platform: OEM729, OEM7600, OEM7700, OEM7720, PwrPak7, SPAN CPT7, SMART7-I, SMART7-SI

This log contains the current IP interface statistics.

Message ID: 1669

Log Type: Polled

Recommended Input:

```
log ipstatsa
```

ASCII Example:

```
#IPSTATSA,COM1,0,70.5,FINESTEERING,1749,328376.337,02000020,0d94,45068;1,CELL,0,526,526*01c4847c
```

Field	Field Type	Description	Format	Binary Bytes	Binary Offset
1	IPSTATS header	Log header. See <i>Messages</i> on page 27 for more information.		H	0
2	#Interface	Number of records to follow.	Ulong	4	H
3	Physical Interface	IP Interface Type 1 = ALL 2 = ETHA	Enum	4	H+4
4	Reserved		Ulong	4	H+8
5	Receive Bytes	Total number of bytes received	Ulong	4	H+12
6	Transmit Bytes	Total number of bytes transmitted	Ulong	4	H+16
7	Next reading offset = H+4+(#Interface * 16)				
8	xxxx	32-bit CRC (ASCII and Binary only)	Hex	4	H+4+ (#Interface * 16)
9	[CR][LF]	Sentence terminator (ASCII only)	-	-	-

3.64 IPSTATUS

Current network configuration status

Platform: OEM729, OEM7600, OEM7700, OEM7720, PwrPak7, SPAN CPT7, SMART7-I, SMART7-SI

This log provides the configuration of IP address, netmask, gateway and a list of DNS servers currently in use.

Message ID: 1289

Log Type: Polled

Recommended Input:

```
log ipstatusa once
```

ASCII Example:

```
#IPSTATUSA,COM1,0,90.5,FINESTEERING,1609,500464.121,02000000,7fe2,6259;1,ETHA,"10.4.44.131","255.255.255.0","10.4.44.1",1,"198.161.72.85"*ec22236c
```

Field	Field Type	Description	Format	Binary Bytes	Binary Offset
1	IPSTATUS Header	Log header. See <i>Messages</i> on page 27 for more information.	-	H	0
2	#IPrec	Number of records to follow	Ulong	4	H
3	interface	Name of the network interface 2 = ETHA	Enum	4	H+4
4	IP address	IP Address-decimal dot notation	String [16]	variable 1	H+8
5	netmask	Netmask-decimal dot notation	String [16]	variable 1	H+24
6	gateway	Gateway-decimal dot notation This is the default gateway that is currently in use by the receiver.	String [16]	variable 1	H+40
7...	Next reading offset = H+4+(#IPrec * 52)				
8	#dnserver	Number of DNS Servers to follow	Ulong	4	H+4+ (#IPrec x 52)

¹In the binary case, each string field needs to be NULL terminated and additional bytes of padding added to maintain 4-byte alignment, up to the maximum defined by the string size. The next defined field starts immediately at the next 4-byte alignment following the NULL.

Field	Field Type	Description	Format	Binary Bytes	Binary Offset
9	server IP address	IP address-decimal dot notation	String [16]	variable 1	H+4+ (#IPrec x 52)+4
10...	Next reading offset = $H+4+(\#IPrec * 52)+4+(\#dnserver * 16)$				
11	xxxx	32-bit CRC (ASCII and Binary only)	Hex	4	H+4+ (#IPrec x 52)+4+ (#dnserver x 16)
12	[CR][LF]	Sentence terminator (ASCII only)	-	-	-

3.65 ITBANDPASSBANK

Allowable band pass filter configurations

Platform: OEM719, OEM729, OEM7500, OEM7600, OEM7700, OEM7720, PwrPak7, SPAN CPT7, SMART7, SMART2

The ITBANDPASSBANK log provides information on the allowable configurations for each frequency when applying a bandpass filter. The current filters in use can be seen with the **ITFILTABLE** log on page 491.

Message ID: 2022

Log Type: Asynch

Recommended Input:

```
log itbandpassbanka once
```

Abbreviated ASCII Example:

```
<ITBANDPASSBANK USB1 0 87.5 FINESTEERING 1933 346809.694 12000020 fb2e 14137
5
GPSL5 1164.3750 1173.1250 1178.1250 1186.8750 0.05
GALILEOE5B 1195.6250 1204.3750 1209.3750 1218.1250 0.05
BEIDOUNB1 1551.2500 1560.0000 1565.0000 1573.7500 0.05
BEIDOUNB2 1195.6250 1204.3750 1209.3750 1218.1250 0.05
QZSSL5 1164.3750 1173.1250 1178.1250 1186.8750 0.05
```

Field	Field Type	Description	Format	Binary Bytes	Binary Offset
1	ITBANDPASSBANK header	Log header. See <i>Messages</i> on page 27 for more information.	-	H	0
2	# of entries	Number of entries to follow	Ulong	4	H
3	frequency	See <i>Table 37: Frequency Types</i> on page 168	Enum	4	H+4
4	min lower frequency cutoff	The minimum frequency cutoff at the lower end (MHz)	Float	4	H+8
5	max lower frequency cutoff	The maximum frequency cutoff at the lower end (MHz)	Float	4	H+12
6	min upper frequency cutoff	The minimum frequency cutoff at the upper end (MHz)	Float	4	H+16
7	max upper frequency cutoff	The maximum frequency cutoff at the upper end (MHz)	Float	4	H+20
8	frequency step	The minimum cut off frequency resolution (MHz)	Float	4	H+24
9	Next entry offset = H + 4 + (#entries * 24)				

Field	Field Type	Description	Format	Binary Bytes	Binary Offset
10	xxxx	32-bit CRC (ASCII and Binary only)	Ulong	4	H+4+ (#entries * 24)
11	[CR][LF]	Sentence terminator (ASCII only)	-	-	-

3.66 ITDETECTSTATUS

Interference detection status

Platform: OEM719, OEM729, OEM7500, OEM7600, OEM7700, OEM7720, PwrPak7, SPAN CPT7, SMART7, SMART2

This log lists all of the detected interferences from all active paths where interference detection is enabled.



This log should be used with the **onchanged** trigger only.

Message ID: 2065

Log Type: Asynch

Recommended Input:

```
log itdetectstatusa onchanged
```

ASCII Example

```
#ITDETECTSTATUSA,USB2,0,74.0,FINESTEERING,1982,430605.267,0200c000,7fdb,32768;
3,
L1,STATISTICANALYSIS,-0.718,29.167,0.126,12.797,00000000,00000000,00000000,
L2,SPECTRUMANALYSIS,1249.961,71.191,-56.769,-132.907,00000000,00000000,
00000000,
L2,SPECTRUMANALYSIS,1289.512,1.978,-75.967,-138.493,00000000,00000000,
00000000*5e83b175
```

Field	Field Type	Description	Format	Binary Bytes	Binary Offset
1	ITDETECTSTATUS header	Log header. See <i>Messages</i> on page 27 for more information.	-	H	0
2	# of entries	Number of interferences to follow	Ulong	4	H
3	RF Path	RF path for this entry. 2 = L1 3 = L2 5 = L5	Enum	4	H+4
4	Interference detection type	Interference detection type for this entry. 0 = SPECTRALANALYSIS 1 = STATISTICALANALYSIS	Enum	4	H+8

Field	Field Type	Description	Format	Binary Bytes	Binary Offset
5	Parameter 1	The first parameter of the interference. For SPECTRALANALYSIS type, this is the center frequency in MHz. For STATISTICALANALYSIS type, this is reserved.	Float	4	H+12
6	Parameter 2	The second parameter of the interference. For SPECTRALANALYSIS type, this is the bandwidth in MHz. For STATISTICALANALYSIS type, this is reserved.	Float	4	H+16
7	Parameter 3	The third parameter of the interference. For SPECTRALANALYSIS type, this is the estimated power in dBm of the interference. For STATISTICALANALYSIS type, this is reserved.	Float	4	H+20
8	Parameter 4	The fourth parameter of the interference. For SPECTRALANALYSIS type, this is the highest estimated power spectrum density in dBmHz of the interference. For STATISTICALANALYSIS type this is reserved.	Float	4	H+24
9	Reserved 1	Reserved	Ulong	4	H+28
10	Reserved 2	Reserved	Ulong	4	H+32
11	Reserved 3	Reserved	Ulong	4	H+36
12	Next interference signal offset = $H + 4 + (\#entries * 36)$				
13	xxxx	32-bit CRC (ASCII and Binary only)	Ulong	4	H=4+ (#entries * 36)
14	[CR][LF]	Sentence terminator (ASCII only)	-	-	-

3.67 ITFILTTABLE

Filter configuration for each frequency

Platform: OEM719, OEM729, OEM7500, OEM7600, OEM7700, OEM7720, PwrPak7, SPAN CPT7, SMART7, SMART2

The ITFILTTABLE log contains the filter configuration summary for each frequency. It lists which bandpass or notch filters are enabled and how each is configured.

Message ID: 1991

Log Type: Asynch

Recommended Input:

```
log itfilttablea once
```

ASCII Example:

```
#ITFILTTABLEA,USB2,0,80.5,FINESTEERING,1923,232588.825,12000000,35d0,32768;
13,
GPSL1,8,CIC3,00000001,DISABLE,0.0000,0.0000,1,
ENABLE,PF0,NOTCHFILTER,1572.2500,1577.7500,1.000,
GPSL2,4,CIC3,00000000,DISABLE,0.0000,0.0000,0,
GLONASSL1,9,CIC3,00000000,DISABLE,0.0000,0.0000,0,
GLONASSL2,5,CIC3,00000000,DISABLE,0.0000,0.0000,0,
GPSL5,0,CIC3,00000000,DISABLE,0.0000,0.0000,0,
...
QZSSL1,8,CIC3,00000001,DISABLE,0.0000,0.0000,1,
ENABLE,PF0,NOTCHFILTER,1572.2500,1577.7500,1.000,
QZSSL2,4,CIC3,00000000,DISABLE,0.0000,0.0000,0,
QZSSL5,0,CIC3,00000000,DISABLE,0.0000,0.0000,0*3ca84167
```

Field	Field Type	Description	Format	Binary Bytes	Binary Offset
1	ITFILTTABLE header	Log header. See <i>Messages</i> on page 27 for more information.	-	H	0
2	# entries	Number of records with information to follow	Ulong	4	H
3	frequency	The frequency at which the filter is applied. See <i>Table 37: Frequency Types</i> on page 168	Enum	4	H+4
4	Encoder ID	ID of the digital path used by this frequency	Ulong	4	H+8
5	DDC filter type	The DDC filter type (see <i>Table 95: DDC Filter Type</i> on the next page)	Enum	4	H+12
6	status word	Filter warning limit status. Raise a warning flag if the filter is placed too close to the center frequency of the GNSS signal (see <i>Table 96: ITFILTTABLE Status Word</i> on page 493)	Ulong	4	H+16

Field	Field Type	Description	Format	Binary Bytes	Binary Offset
7	switch	Filter is enabled or disabled (see <i>Table 97: Filter Switches</i> on page 494)	Enum	4	H+20
8	lower cut off frequency	Cut off frequency at the lower end (MHz)	Float	4	H+24
9	upper cut off frequency	Cut off frequency at the upper end (MHz)	Float	4	H+28
10	# prog filters	Number of programmable filters applied	Ulong	4	H+32
11	switch	Filter is enabled or disabled (see <i>Table 97: Filter Switches</i> on page 494)	Enum	4	H+36
12	prog filter ID	The programmable filter ID (see <i>Table 34: Programmable Filter ID</i> on page 165)	Enum	4	H+40
13	mode	Programmable filter mode (notch filter or bandpass) (see <i>Table 35: Programmable Filter Mode</i> on page 165)	Enum	4	H+44
14	lower cut off frequency	Cut off frequency at the lower end (MHz)	Float	4	H+48
15	upper cut off frequency	Cut off frequency at the upper end (MHz)	Float	4	H+52
16	notch width	Width of notch filter (MHz)	Float	4	H+56
17	Next programmable filter – variable binary offset				
18	Next frequency – variable binary offset				
19	xxxx	32-bit CRC (ASCII and Binary only)	Ulong	4	variable
20	[CR][LF]	Sentence terminator (ASCII only)	-	-	-

Table 95: DDC Filter Type

Binary	ASCII
0	PASSTHROUGH
1	CIC1
2	CIC2
3	CIC3
4	HALFBAND

Table 96: ITFILTable Status Word

Nibble	Bit	Mask	Description	Range Value
N0	0	0x00000001	First enabled filter	0 = Within acceptable limit 1 = Warning
	1	0x00000002		
	2	0x00000004		
	3	0x00000008		
N1	4	0x00000010		
	5	0x00000020		
	6	0x00000040		
	7	0x00000080		
N2	8	0x00000100	Second enabled filter	0 = Within acceptable limit 1 = Warning
	9	0x00000200		
	10	0x00000400		
	11	0x00000800		
N3	12	0x00001000		
	13	0x00002000		
	14	0x00004000		
	15	0x00008000		
N4	16	0x00010000	Third enabled filter	0 = Within acceptable limit 1 = Warning
	17	0x00020000		
	18	0x00040000		
	19	0x00080000		
N5	20	0x00100000		
	21	0x00200000		
	22	0x00400000		
	23	0x00800000		

Nibble	Bit	Mask	Description	Range Value
N6	24	0x01000000	Fourth enabled filter	0 = Within acceptable limit 1 = Warning
	25	0x02000000		
	26	0x04000000		
	27	0x08000000		
N7	28	0x10000000		
	29	0x20000000		
	30	0x40000000		
	31	0x80000000		

Table 97: Filter Switches

Binary Value	ASCII Value	Description
0	DISABLE	Filter disabled
1	ENABLE	Filter enabled

3.68 ITPROGFILTBANK

Allowable filter configurations

Platform: OEM719, OEM729, OEM7500, OEM7600, OEM7700, OEM7720, PwrPak7, SPAN CPT7, SMART7, SMART2

The ITPROGFILTBANK log provides information on the allowable configurations for the programmable filter for each frequency when applying either a notch filter or bandpass filter. The current filters in use can be seen with the **ITFILTABLE** log on page 491.

Message ID: 2023

Log Type: Asynch

Recommended Input:

```
log itprogfilbanka once
```

Abbreviated ASCII Example:

```
<ITPROGFILTBANK USB1 0 88.0 FINESTEERING 1933 346362.985 12000020 3696 14137
12
```

```
GPSL1 5
```

```
NOTCHFILTER 1563.0000 1574.0000 1576.0000 1587.0000 0.05 0.15
NOTCHFILTER 1563.7500 1573.6000 1576.4000 1586.2500 0.05 0.50
NOTCHFILTER 1564.0500 1573.3000 1576.7000 1585.9500 0.05 1.00
NOTCHFILTER 1565.7500 1571.7000 1578.3000 1584.2500 0.05 2.50
BANDPASSFILTER 1563.7500 1572.5000 1577.5000 1586.2500 0.05 0.00
```

```
GPSL2 5
```

```
NOTCHFILTER 1215.5000 1226.5000 1228.5000 1239.5000 0.05 0.15
NOTCHFILTER 1216.2500 1226.1000 1228.9000 1238.7500 0.05 0.50
NOTCHFILTER 1216.5500 1225.8000 1229.2000 1238.4500 0.05 1.00
NOTCHFILTER 1218.2500 1224.2000 1230.8000 1236.7500 0.05 2.50
BANDPASSFILTER 1216.2500 1225.0000 1230.0000 1238.7500 0.05 0.00
```

```
GLONASSL1 5
```

```
NOTCHFILTER 1589.5625 1600.5625 1602.5625 1613.5625 0.05 0.15
NOTCHFILTER 1590.3125 1600.1625 1602.9625 1612.8125 0.05 0.50
NOTCHFILTER 1590.6125 1599.8625 1603.2625 1612.5125 0.05 1.00
NOTCHFILTER 1592.3125 1598.2625 1604.8625 1610.8125 0.05 2.50
BANDPASSFILTER 1590.3125 1599.0625 1604.0625 1612.8125 0.05 0.00
```

```
...
```

Field	Field Type	Description	Format	Binary Bytes	Binary Offset
1	ITPROGFILTBANK header	Log header. See <i>Messages</i> on page 27 for more information.	-	H	0
2	# entries	Number of entries to follow	Ulong	4	H

Field	Field Type	Description	Format	Binary Bytes	Binary Offset
3	frequency	See <i>Table 37: Frequency Types</i> on page 168	Enum	4	H+4
4	# prog filters	Number of programmable filters applied with information to follow	Ulong	4	H+8
5	mode	Programmable filter mode (notch filter or bandpass) (see <i>Table 35: Programmable Filter Mode</i> on page 165)	Enum	4	H+12
6	min lower frequency cutoff	The minimum frequency cutoff at the lower end (MHz)	Float	4	H+16
7	max lower frequency cutoff	The maximum frequency cutoff at the lower end (MHz)	Float	4	H+20
8	min upper frequency cutoff	The minimum frequency cutoff at the upper end (MHz)	Float	4	H+24
9	max upper frequency cutoff	The maximum frequency cutoff at the upper end (MHz)	Float	4	H+28
10	frequency step	The minimum cut off frequency resolution (MHz)	Float	4	H+32
11	notch width	Width of notch filter (MHz)	Float	4	H+36
12	Next programmable filter – variable binary offset				
13	Next frequency – variable binary offset				
14	xxxx	32-bit CRC (ASCII and Binary only)	Ulong	4	variable
15	[CR][LF]	Sentence terminator (ASCII only)			

3.69 ITPSDFINAL

Processed power spectral density

Platform: OEM719, OEM729, OEM7500, OEM7600, OEM7700, OEM7720, PwrPak7, SPAN CPT7, SMART7, SMART2

The ITPSDFINAL log contains the samples for the spectral analysis. The rate and size is set by the update period and the FFT size respectively when issuing the **ITSPECTRALANALYSIS** command (see page 166).

PSD samples are compressed into 2 byte samples to reduce log sizes. The range of values that can be displayed is -200 dBm to +56 dBm with a 1/256 resolution. The following steps should be performed on the PSD samples in this log to convert them back into dBm units for display purposes:

1. Divide the sample by 256.0
2. Subtract 200

The number of samples are calculated according to the following table. The maximum number of samples in one ITPSDFINAL log is 1024. That means if the number of samples is less than 1024, one log is enough to output them. However, if the number of samples is larger than 1024, more than one ITPSDFINAL log is needed. For example, in postdecimation mode with the FFT size of 8K and subcarrier integration of 5, there is one log with 1024 samples and another log with 614 samples. The output logs can be grouped together through the sequence number of the log header.

Data Source	Number of Samples
PREDECIMATION	$\text{FFTsize}/(2*\text{subcarrier_integration})$
POSTDECIMATION	$\text{FFTsize}/\text{subcarrier_integration}$
POSTFILTER	$\text{FFTsize}/\text{subcarrier_integration}$



As the data rate for the ITPSDFINAL log is dictated by the updateperiod parameter in the **ITSPECTRALANALYSIS** command (see page 166), do not use ONTIME to log this message. Instead use ONNEW to log ITPSDFINAL.



The pre-decimation spectrum shows the absolute power in dBm which is proportional to the resolution bandwidth (RBW). The post-decimation and post-filter spectrum shows the signal magnitude in relative power (dB).

Message ID: 1968

Log Type: Asynch

Recommended Input:

```
log itpsdfinala onnew
```

ASCII Example

```
#ITPSDFINALA, UNKNOWN, 0, 66.0, FINESTEERING, 1891, 166978.221, 02040000, b79a, 32768;
1310752, 1531.250, 195312.500, 512, 28033, 30370, 30225, 29190, 27254, 29521, 32694,
```

33025,28553,28902,29060,26663,30267,30054,

...

34027,38038,31082,29418,28805,27373,27869,28847,28331,31901,30251,33625,33625

*000b928d

Field	Field Type	Description	Format	Binary Bytes	Binary Offset
1	ITPSDFINAL header	Log header. See <i>Messages</i> on page 27 for more information.	-	H	0
2	status word	Status word containing information about the configuration of the spectral analysis (see <i>Table 98: Spectral Analysis Status Word</i> below)	Ulong	4	H
3	frequency start	Frequency represented by first data sample (MHz)	Float	4	H+4
4	resolution bandwidth	The resolution bandwidth (Hz)	Float	4	H+8
5	# samples	Number of spectral density samples	Ulong	4	H+12
6	sample	Power spectral density sample	Ushort	2	H+16
7	Next sample = H+16+(2*#samples)				
8	xxxx	32-bit CRC (ASCII and Binary only)	Ulong	4	H+16+ (2*# samples)
9	[CR][LF]	Sentence terminator (ASCII only)	-	-	-

Table 98: Spectral Analysis Status Word

Nibble	Bit	Mask	Description	Range Value
N0	0	0x00000001	Frequency	0 – 20 See <i>Table 37: Frequency Types</i> on page 168
	1	0x00000002		
	2	0x00000004		
	3	0x00000008		
N1	4	0x00000010	Data Source	0 – 3 See <i>Table 36: Data Sources for PSD Samples</i> on page 167
	5	0x00000020		
	6	0x00000040		
	7	0x00000080		

Nibble	Bit	Mask	Description	Range Value
N2	8	0x00000100	FFT Size	0 – 6 See Table 38: FFT Sizes on page 169
	9	0x00000200		
	10	0x00000400		
N3	11	0x00000800	Integration Window	1 – 1024 samples
	12	0x00001000		
	13	0x00002000		
	14	0x00004000		
N4	15	0x00008000	Time Average Window	0 – 100 seconds
	16	0x00010000		
	17	0x00020000		
	18	0x00040000		
N5	19	0x00080000	Reserved	
	20	0x00100000		
	21	0x00200000		
	22	0x00400000		
N6	23	0x00800000	Reserved	
	24	0x01000000		
	25	0x02000000		
	26	0x04000000		
N7	27	0x08000000	Reserved	
	28	0x10000000		
	29	0x20000000		
	30	0x40000000		
N7	31	0x80000000	Reserved	

3.70 J1939STATUS

Status of CAN J1939 Node

Platform: OEM719, OEM729, OEM7500, OEM7600, OEM7700, OEM7720, PwrPak7, SPAN CPT7, SMART7, SMART2

This logs reports the status of J1939 node, specifically J1939 Address Claim function (initiated using the **J1939CONFIG** command (see page 170)).

This log displays the status only for nodes that have been set.

Message ID: 1907

Log Type: Asynch

Recommended Input:

```
LOG J1939STATUSA ONCHANGED
```

ASCII Examples:

```
#J1939STATUSA,COM1,1,81.0,UNKNOWN,0,0.000,02004020,e9ce,32768;NODE1,DISABLED,0,FE*637c7f
```

```
#J1939STATUSA,COM1,0,81.0,UNKNOWN,0,0.000,02004020,e9ce,32768;NODE2,DISABLED,0,FE*c41af5ee
```

Field	Field Type	Description	Format	Binary Bytes	Binary Offset
1	J1939STATUS header	Log header. See <i>Messages</i> on page 27 for more information.	-	H	0
2	node	J1939 Node. The node can be either NODE1 or NODE2.	Enum	4	H
3	status	Node status. See <i>Table 99: Node Status</i> on the next page	Enum	4	H+4
4	count	Number of attempts that were made to claim address. This will be 1 when the preferred address is used and may be more if the alternate range is used.	Ulong	4	H+8
5	address	Claimed CAN Address. 0xFE (NULL address) if the address could not be negotiated.	Uchar	1	H+12
6	xxxx	32-bit CRC (ASCII and Binary only)	Hex	4	H+13
7	[CR][LF]	Sentence Terminator (ASCII only)	-	-	-

Table 99: Node Status

Value	ASCII	Description
1	DISABLED	Address claim activity is not taking place. The node does not have J1939 enabled.
2	CLAIMING	Address claim procedure is in progress.
3	CLAIMED	Address claimed successfully. Ready for data transfer.
4	FAILED	Address claim was not successful. No further activity is taking place.

3.71 LBANDBEAMTABLE

List of L-Band beams

Platform: OEM719, OEM729, OEM7500, OEM7600, OEM7700, OEM7720, PwrPak7, SPAN CPT7, SMART7, SMART2

This log lists the TerraStar and Veripos L-Band beams known to the receiver.

Message ID: 1718

Log Type: Asynch

Recommended Input:

```
log lbandbeamtablea onchanged
```

Abbreviated ASCII Example:

```
<LBANDBEAMTABLE COM1 0 69.0 UNKNOWN 0 1.283 02044008 19b8 32768
< 8
< "AORE" "A" 1545855000 1200 -15.50 1
< "AORW" "B" 1545845000 1200 -54.00 1
< "IOR" "C" 1545865000 1200 64.50 1
< "POR" "D" 1545905000 1200 178.00 1
< "25E" "E" 1545825000 1200 25.00 1
< "143.5E" "F" 1545835000 1200 143.50 1
< "98W" "G" 1545865000 1200 -98.00 1
< "SP98W1" "SP98W1" 1545885000 1200 -98.00 1
```

Field	Field type	Description	Format	Binary Bytes	Binary Offset
1	LBANDBEAMTABLE header	Log header. See <i>Messages</i> on page 27 for more information.		H	0
2	#entries	Number of records to follow	Ulong	4	H
3	Name	Beam/transmitting satellite name	Char[8]	8	H+4
4	Reserved		Char[8]	8	H+12
5	Frequency	Frequency (Hz)	Ulong	4	H+20
6	Baud	Baud rate (bps)	Ulong	4	H+24
7	Longitude	Transmitting satellite longitude (degrees)	Float	4	H+28
8	Access	Beam service availability flag 0 = Denied 1 = Granted	Ulong	4	H+32
9	Next beam offset = H + 4 + (#entries * 32)				

Field	Field type	Description	Format	Binary Bytes	Binary Offset
10	xxxx	32-bit CRC (ASCII and Binary only)	Ulong	4	H+4+ (#entries * 32)
11	[CR][LF]	Sentence terminator (ASCII only)	-	-	-

3.72 LBANDTRACKSTAT

L-Band Beams status

Platform: OEM719, OEM729, OEM7500, OEM7600, OEM7700, OEM7720, PwrPak7, SPAN CPT7, SMART7, SMART2

This log reports the L-Band tracking and Viterbi decoding status for the tracked L-Band beams.



The maximum logging rate for LBANDTRACKSTAT is 2 Hz.

Message ID: 1201

Log Type: Synch

Recommended Input:

```
log lbandtrackstata ontime 1
```

ASCII Example:

```
#LBANDTRACKSTATA, COM2, 0, 82.5, FINESTEERING, 2054, 406100.000, 02004000, 29e3, 15526;
5,
"98W", 1545865000, 1200, 974c, 00c2, 0, -141.268, 40.765, 3.2063, 7333.552, 139648, 0, 0,
17874944, 34, 0.0000,
"AORW", 1545845000, 1200, 974c, 00c2, 0, -170.379, 43.710, 3.5375, 7331.935, 139584, 1, 1,
17866752, 27, 0.0000,
"POR", 1545905000, 1200, 974c, 0000, 0, -160.064, 0.000, 0.0000, 0.000, 0, 0, 0, 0, 0, 0.0000,
"", 0, 0, 0000, 0003, 0, 0.000, 0.000, 0.0000, 0.000, 0, 0, 0, 0, 0, 0.0000,
"", 0, 0, 0000, 0003, 0, 0.000, 0.000, 0.0000, 0.000, 0, 0, 0, 0, 0, 0.0000*d5311c69
```

Field	Field type	Description	Format	Binary Bytes	Binary Offset
1	LBANDTRACKSTAT header	Log header. See <i>Messages</i> on page 27 for more information.		H	0
2	#entries	Number of records to follow	Ulong	4	H
3	Name	Beam/transmitting satellite name	Char[8]	8	H+4
4	Frequency	Frequency assigned to this L-Band beam (Hz)	Ulong	4	H+12
5	Baud rate	Baud rate of assigned beam	Ushort	2	H+16
6	ID	Service ID of the assigned beam	Ushort	2	H+18
7	Status	Tracking status word. See <i>Table 100: L-Band Signal Tracking Status</i> on the next page	Ushort	2	H+20
8	Reserved	Reserved	Ushort	2	H+22
9	Doppler	Signal Doppler (Hz)	Float	4	H+24

Field	Field type	Description	Format	Binary Bytes	Binary Offset
10	C/No	Carrier to noise density ratio (dB-Hz)	Float	4	H+28
11	Phase std. dev.	Phase error standard deviation (cycles)	Float	4	H+32
12	Lock time	Lock time (s)	Float	4	H+36
13	Unique word bits	Total unique word bits	Ulong	4	H+40
14	Bad unique word bits	Bad unique word bits	Ulong	4	H+44
15	Bad unique words	Bad unique words	Ulong	4	H+48
16	Viterbi symbols	Total Viterbi symbols	Ulong	4	H+52
17	Corrected Viterbi	Corrected Viterbi symbols	Ulong	4	H+56
18	Bit error rate	Estimated pre-Viterbi Bit Error Rate (BER)	Float	4	H+60
19	Next entry offset = H + 4 + (#entries x 60)				
20	xxxx	32-bit CRC (ASCII and Binary only)	Hex	4	H+4+ (#entries x 60)
21	[CR][LF]	Sentence terminator (ASCII only)	-	-	-

Table 100: L-Band Signal Tracking Status

Nibble	Bit	Mask	Description	Range Value
N0	0	0x0001	Tracking State	0 = Searching, 1 = Pull-in, 2 = Tracking, 3 = Idle
	1	0x0002		
	2	0x0004	Reserved	
3	0x0008			
N1	4	0x0010		
	5	0x0020		
	6	0x0040	Bit Timing Lock	0 = Not Locked, 1 = Locked
	7	0x0080	Phase Locked	0 = Not Locked, 1 = Locked

Nibble	Bit	Mask	Description	Range Value
N2	8	0x0100	DC Offset Unlocked	0 = Good, 1 = Warning
	9	0x0200	AGC Unlocked	0 = Good, 1 = Warning
	10	0x0400	Reserved	
11	0x0800			
N3	12	0x1000		
	13	0x2000		
	14	0x4000		
	15	0x8000	Error	0 = Good, 1 = Error

3.73 LOGLIST

List of system logs

Platform: OEM719, OEM729, OEM7500, OEM7600, OEM7700, OEM7720, PwrPak7, SPAN CPT7, SMART7, SMART2

This log lists which messages are currently being logged to each port and when. The following tables show the binary and ASCII output. See also the **RXCONFIG** log on page 684 for a list of current command settings.

Message ID: 5

Log Type: Polled

Recommended Input:

```
log loglista once
```

ASCII Example:

```
#LOGLISTA,COM1,0,60.5,FINESTEERING,1337,398279.996,02000000,c00c,1984; 8,
COM1,RXSTATUSEVENTA,ONNEW,0.000000,0.000000,HOLD,
COM2,RXSTATUSEVENTA,ONNEW,0.000000,0.000000,HOLD,
COM3,RXSTATUSEVENTA,ONNEW,0.000000,0.000000,HOLD,
USB1,RXSTATUSEVENTA,ONNEW,0.000000,0.000000,HOLD,
USB2,RXSTATUSEVENTA,ONNEW,0.000000,0.000000,HOLD,
USB3,RXSTATUSEVENTA,ONNEW,0.000000,0.000000,HOLD,
COM1,BESTPOSA,ONTIME,10.000000,0.000000,NOHOLD,
COM1,LOGLISTA,ONCE,0.000000,0.000000,NOHOLD*5b29eed3
```



Do not use undocumented logs or commands. Doing so may produce errors and void your warranty.

3.73.1 Binary

Field	Field type	Description	Format	Binary Bytes	Binary Offset
1	LOGLIST (binary) header	Log header. See <i>Messages</i> on page 27 for more information.		H	0
2	#logs	Number of messages to follow, maximum = 80	Ulong	4	H
3	port	Output port, see <i>Table 4: Detailed Port Identifier</i> on page 33	Enum	4	H+4
4	message	Message ID of the log	Ushort	2	H+8

Field	Field type	Description	Format	Binary Bytes	Binary Offset
5	message type	Bits 0-4 = Reserved Bits 5-6 = Format 00 = Binary 01 = ASCII 10 = Abbreviated ASCII, NMEA 11 = Reserved Bit 7 = Response Bit (see <i>Message Responses</i> on page 42) 0 = Original Message 1 = Response Message	Char	1	H+10
6	Reserved		Char	1	H+11
7	trigger	0 = ONNEW 1 = ONCHANGED 2 = ONTIME 3 = ONNEXT 4 = ONCE 5 = ONMARK	Enum	4	H+12
8	period	Log period for ONTIME	Double	8	H+16
9	offset	Offset for period (ONTIME trigger)	Double	8	H+24
10	hold	0 = NOHOLD 1 = HOLD	Enum	4	H+32
11...	Next log offset = H + 4 + (#logs x 32)				
variable	xxxx	32-bit CRC	Hex	4	H+4+ (#logs x 32)

3.73.2 ASCII

Field	Field type	Description	Format
1	LOGLIST (ASCII) header	Log header. See <i>Messages</i> on page 27 for more information.	
2	#port	Number of messages to follow, maximum = 80	Long
3	port	Output port, see <i>Table 4: Detailed Port Identifier</i> on page 33	Enum
4	message	Message name of log with no suffix for abbreviated ASCII, an A suffix for ASCII and a B suffix for binary	Char []

Field	Field type	Description	Format
5	trigger	ONNEW ONCHANGED ONTIME ONNEXT ONCE ONMARK	Enum
6	period	Log period for ONTIME	Double
7	offset	Offset for period (ONTIME trigger)	Double
8	hold	NOHOLD HOLD	Enum
9...	Next port		
variable	xxxx	32-bit CRC	Hex
variable	[CR][LF]	Sentence terminator	-

3.74 LUAFILELIST

List available Lua scripts

Platform: OEM719, OEM729, OEM7500, OEM7600, OEM7700, OEM7720, PwrPak7, SPAN CPT7, SMART7

This sequenced log informs the user of the available scripts, obtained from the ISO loaded onto the receiver. The size of the file, last change date in yyyyymmdd format, last change time in hhmmss format, and path to the files are printed as well.

Message ID: 2151

Log Type: Polled

Recommended Input:

LOG LUAFILELIST

Abbreviated ASCII Example:

```
[COM1]<LUAFILELIST COM1 6 89.5 UNKNOWN 0 4.000 02444020 b447 14635
< 0 20180202 151403 "/lua/uppercase.lua"
<LUAFILELIST COM1 5 90.5 UNKNOWN 0 4.000 02444020 b447 14635
< 2706 20180129 152042 "/lua/debugloop.lua"
<LUAFILELIST COM1 4 90.5 UNKNOWN 0 4.000 02444020 b447 14635
< 4692 20180202 110107 "/lua/parsetime.lua"
<LUAFILELIST COM1 3 90.5 UNKNOWN 0 4.000 02444020 b447 14635
< 4764 20180205 105415 "/lua/scom_rx.lua"
<LUAFILELIST COM1 2 90.5 UNKNOWN 0 4.000 02444020 b447 14635
< 3728 20180202 104830 "/lua/scomtunnel.lua"
<LUAFILELIST COM1 1 90.5 UNKNOWN 0 4.000 02444020 b447 14635
< 3044 20180201 144849 "/lua/scriptargs.lua"
<LUAFILELIST COM1 0 90.5 UNKNOWN 0 4.000 02444020 b447 14635
< 2337 20180129 155140 "/lua/sendtocom2.lua"
```

Field	Field Type	Description	Format	Binary Bytes	Binary Offset
1	LUAFILELIST header	Log header. See Messages for more information.	-	H	0
2	Size	File size (in Bytes)	Ulong	4	H
3	Date	Last change date When viewed as a string, the date is of the form YYYYMMDD. So, numerically, the date is (Year * 10000) + (Month * 100) + (Day).	Ulong	4	H+4
4	Time	Last change time When viewed as a string, the time is HHMMSS. So, numerically, the time is (Hour * 10000) + (Minute * 100) + (Second).	Ulong	4	H+8

Field	Field Type	Description	Format	Binary Bytes	Binary Offset
5	Path	The path to the Lua script The maximum length of this string is 256 bytes.	String	Variable	H+12

3.75 LUAFILESYSTEMSTATUS

Query mount status of Lua scripts

Platform: OEM719, OEM729, OEM7500, OEM7600, OEM7700, OEM7720, PwrPak7, SPAN CPT7, SMART7

Use this log to query the mount status of the ISO image that contains the Lua scripts loaded on to the receiver.

Message ID: 2150

Log Type: Asynch

Recommended Input:

```
LOG LUAFILESYSTEMSTATUS
```

Abbreviated ASCII Example:

```
<LUAFILESYSTEMSTATUS COM1 0 90.0 UNKNOWN 0 0.204 02444020 b8f8 14635
< MOUNTED ""
```

Field	Field Type	Description	Format	Binary Bytes	Binary Offset
1	LUAFILESYSTEMSTATUS header	Log header. See Messages for more information.		H	0
2	Status	The status of the file system. See <i>Table 101: File System Status</i> below.	Enum	4	H
3	Error	String that indicates the error message if mounting fails The maximum length of this string is 52 bytes.	String	Variable	H+4

Table 101: File System Status

Value	Description
1	UNMOUNTED
2	MOUNTED
3	BUSY
4	ERROR
5	UNMOUNTING
6	MOUNTING

3.76 LUAOUTPUT

Output stderr and stdout from the Lua interpreter

Platform: OEM719, OEM729, OEM7500, OEM7600, OEM7700, OEM7720, PwrPak7, SPAN CPT7, SMART7

Use this log to output `stderr` and `stdout` messages from the Lua interpreter.

Message ID: 2240

Log Type: Asynch

Recommended Input:

```
LOG LUAOUTPUT ONNEW
```

Abbreviated ASCII Example:

```
<LUAOUTPUT 0 346044.929
<    1 0 STDOUT "Lua 5.3.4 Copyright (C) 1994-2017 Lua.org, PUC-Rio"
<LUAOUTPUT 0 346044.987
<    2 0 STDOUT "> "
```

Field	Field Type	Description	Format	Binary Bytes	Binary Offset
1	LUAOUTPUT header	Log header. See Messages for more information.	-	H	0
2	Sequence Number	Running number of each LUAOUTPUT log produced by the system	Ulong	4	H
3	Executor Number	Lua Executor Number that produced the data	Ulong	4	H+4
4	Data Source	See <i>Table 102: Lua Data Source</i> below	Enum	4	H+8
5	Data	NULL-terminated string containing a single line of data from <code>stderr</code> or <code>stdout</code> . This string is not terminated with a carriage return or line feed. This string contains only printable characters. The maximum length of this string is 128 bytes.	String	Variable	H+12

Table 102: Lua Data Source

Binary	ASCII	Description
0	STDOUT	Data is from <code>stdout</code>
1	STDERR	Data is from <code>stderr</code>

3.77 LUASTATUS

Display status of Lua scripts

Platform: OEM719, OEM729, OEM7500, OEM7600, OEM7700, OEM7720, PwrPak7, SPAN CPT7, SMART7

Use this log to determine which scripts are running on the receiver and whether the scripts have exited or encountered errors.

Message ID: 2181

Log Type: Collection

Recommended Input:

LOG LUASTATUS

Abbreviated ASCII Example:

```
[COM1]<LUASTATUS COM1 1 84.5 FINESTEERING 1963 402110.866 02400000 2e18 32768
< 0 "icom_rx.lua 127.0.0.1 3001" EXECUTING
<LUASTATUS COM1 0 84.5 FINESTEERING 1963 402110.866 02400000 2e18 32768
< 1 "" NOT_STARTED
```



The example above is for the projected log output for two executors.

Field	Field Type	Description	Format	Binary Bytes	Binary Format
1	LUASTATUS header	Log header. See Messages for more information.		H	0
2	Number	Executor number	Ulong	4	H
3	Script	Script and arguments	String [256]	Variable	H+4
4	Status	Script status. See <i>Table 103: Script Status</i> below.	Enum	4	Variable

Table 103: Script Status

Binary	ASCII	Description
0	NOT_STARTED	There is no script running on the executor
1	EXECUTING	The script is running
2	COMPLETED	The script completed successfully
3	SCRIPT_ERROR	The script exited with an error
4	EXECUTOR_ERROR	The script executor encountered an error while attempting to run the script

3.78 MARKPOS, MARK2POS, MARK3POS and MARK4POS

Position at time of mark input event

Platform: OEM719, OEM729, OEM7500, OEM7600, OEM7700, OEM7720, PwrPak7, SPAN CPT7, SMART2

This log contains the estimated position of the antenna when a pulse is detected at a mark input.

- MARKPOS is generated when a pulse occurs on the MK1I (EVENT_IN1) input.
- MARK2POS is generated when a pulse occurs on the MK2I (EVENT_IN2) input.
- MARK3POS is generated when a pulse occurs on the MK3I (EVENT_IN3) input (OEM7600, OEM7700 and OEM7720 only).
- MARK4POS is generated when a pulse occurs on the MK4I (EVENT_IN4) input (OEM7600, OEM7700 and OEM7720 only).

The position at the mark input pulse is extrapolated using the last valid position and velocities. The latched time of mark impulse is in GPS reference weeks and seconds into the week. The resolution of the latched time is 10 ns. See also the notes on MARKPOS in the **MARK1TIME**, **MARK2TIME**, **MARK3TIME** and **MARK4TIME** log on page 518.



The position for the **MARKPOS**, **MARK2POS**, **MARK3POS** and **MARK4POS** logs are reported in the user selected datum. See the **DATUM** command on page 100 for more details.

Message ID: **181 (MARKPOS)**
 615 (MARK2POS)
 1738 (MARK3POS)
 1739 (MARK4POS)

Log Type: Asynch

Recommended Input:

log markposa onnew



1. Use the ONNEW trigger with the MARKxTIME or MARKxPOS logs.
2. ONMARK only applies to MK1I. Events on MK2I (if available) do not trigger logs when ONMARK is used. Use the ONNEW trigger with the MARK1TIME, MARK2TIME, MARKPOS or MARK2POS logs.
3. Once the 1PPS signal has hit a rising edge, for both MARKxPOS and MARKxTIME logs, a resolution of both measurements is 10 ns. As for the ONMARK trigger for other logs that measure latency, for example RANGE and POSITION logs such as BESTPOS, it takes typically 20-30 ms (50 ms maximum) for the logs to output information from the 1PPS signal. Latency is the time between the reception of the 1PPS pulse and the first byte of the associated log. See also the **MARK1TIME**, **MARK2TIME**, **MARK3TIME** and **MARK4TIME** log on page 518.

Abbreviated ASCII Example:

```
<MARKPOS COM1 0 89.0 FINESTEERING 1670 413138.000 02000020 c223 42770
SOL_COMPUTED SINGLE 51.11289233689 -114.02932170726 1018.9653 1049.4915 BUKIT
1.9372 1.1981 4.0909 "" 0.000 0.000 19 18 18 18 0 06 0 33
```



Consider the case where you have a user point device such as video equipment. Connect the device to the receiver's I/O port using a cable that is compatible to both the receiver and the device. Refer to your device's documentation for information about connectors and cables. The arrow along the cable in the figure below indicates a MARKIN pulse, from the user device on the right to the receiver I/O port.

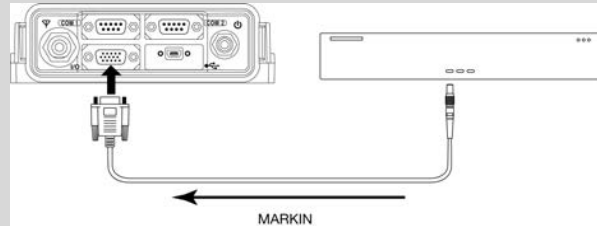

Field	Field type	Description	Format	Binary Bytes	Binary Offset
1	MARKPOS/ MARK2POS/ MARK3POS/ MARK4POS header	Log header. See <i>Messages</i> on page 27 for more information.		H	0
2	sol status	Solution status (see <i>Table 65: Solution Status</i> on page 374)	Enum	4	H
3	pos type	Position type (see <i>Table 66: Position or Velocity Type</i> on page 375)	Enum	4	H+4
4	lat	Latitude (degrees)	Double	8	H+8
5	lon	Longitude (degrees)	Double	8	H+16
6	hgt	Height above mean sea level (m)	Double	8	H+24
7	undulation	Undulation - the relationship between the geoid and the WGS84 ellipsoid (m) <div style="border: 1px solid black; padding: 5px; width: fit-content; margin: 10px auto;"> <p>When using a datum other than WGS84, the undulation value also includes the vertical shift due to differences between the datum in use and WGS84.</p> </div>	Float	4	H+32
8	datum id#	Datum ID number 61 = WGS84 63 = USER	Enum	4	H+36

Field	Field type	Description	Format	Binary Bytes	Binary Offset
9	lat σ	Latitude standard deviation (m)	Float	4	H+40
10	lon σ	Longitude standard deviation (m)	Float	4	H+44
11	hgt σ	Height standard deviation (m)	Float	4	H+48
12	stn id	Base station ID	Char[4]	4	H+52
13	diff_age	Differential age in seconds	Float	4	H+56
14	sol_age	Solution age in seconds	Float	4	H+60
15	#SVs	Number of satellites tracked	Uchar	1	H+64
16	#solnSVs	Number of satellite vehicles used in solution	Uchar	1	H+65
17	#ggL1	Number of satellites with L1/E1/B1 signals used in solution	Uchar	1	H+66
18	#solnMultiSVs	Number of satellites with multi-frequency signals used in solution	Uchar	1	H+67
19	Reserved		Uchar	1	H+68
20	ext sol stat	Extended solution status (see <i>Table 69: Extended Solution Status</i> on page 378)	Hex	1	H+69
21	Galileo and BeiDou sig mask	Galileo and BeiDou signals used mask (see <i>Table 68: Galileo and BeiDou Signal-Used Mask</i> on page 378)	Hex	1	H+70
22	GPS and GLONASS sig mask	GPS and GLONASS signals used mask (see <i>Table 67: GPS and GLONASS Signal-Used Mask</i> on page 377)	Hex	1	H+71
23	xxxx	32-bit CRC (ASCII and Binary only)	Hex	4	H+72
24	[CR][LF]	Sentence terminator (ASCII only)	-	-	-

3.79 MARK1TIME, MARK2TIME, MARK3TIME and MARK4TIME

Time of mark input event

Platform: OEM719, OEM729, OEM7500, OEM7600, OEM7700, OEM7720, PwrPak7, SPAN CPT7, SMART2

This log contains the time of the leading edge of the detected mark input pulse.

- MARK1TIME is generated when a pulse occurs on a MK1I (EVENT_IN1) input
- MARK2TIME is generated when a pulse occurs on a MK2I (EVENT_IN2) input
- MARK3TIME is generated when a pulse occurs on a MK3I (EVENT_IN3) input (OEM7600, OEM7700 and OEM7720 only)
- MARK4TIME is generated when a pulse occurs on a MK4I (EVENT_IN4) input (OEM7600, OEM7700 and OEM7720 only)



The MARKTIME log (message ID 231) is deprecated. Use the MARK1TIME log as a replacement.

The resolution of this measurement is 10 ns.



1. Use the ONNEW trigger with the MARKxTIME or the MARKxPOS logs.
2. Only the MARKxPOS logs, MARKxTIME logs and 'polled' log types are generated 'on the fly' at the exact time of the mark. Synchronous and asynchronous logs output the most recently available data.
3. ONMARK only applies to MK1I. Events on MK2I (if available) do not trigger logs when ONMARK is used. Use the ONNEW trigger with the MARK1TIME, MARK2TIME, MARKPOS or MARK2POS logs.
4. Once the 1PPS signal has hit a rising edge, for both MARKxPOS and MARKxTIME logs, a resolution of both measurements is 10 ns. As for the ONMARK trigger for other logs that measure latency, for example RANGE and POSITION logs such as BESTPOS, it takes typically 20-30 ms (50 ms maximum) for the logs to output information from the 1PPS signal. Latency is the time between the reception of the 1PPS pulse and the first byte of the associated log. See also the **MARKPOS, MARK2POS, MARK3POS and MARK4POS** log on page 515.

Message ID: **1130 (MARK1TIME)**
 616 (MARK2TIME)
 1075 (MARK3TIME)
 1076 (MARK4TIME)

Log Type: Asynch

Recommended Input:

```
log mark1timea onnew
```

ASCII Example:

```
#MARK1TIMEA,COM1,0,77.5,FINESTEERING,1358,422621.000,02000000,292e,2214;1358,42
2621.000000500,-1.398163614e-08,7.812745577e-08,-14.000000002,VALID*d8502226
```



GPS reference time is the receiver's estimate of the true GPS system time. GPS reference time can be found in the header of the log. The relationship between GPS reference time and true GPS system time is:
 GPS system time = GPS reference time - offset

Field	Field type	Description	Format	Binary Bytes	Binary Offset
1	MARK1TIME/ MARK2TIME/ MARK3TIME/ MARK4TIME header	Log header. See <i>Messages</i> on page 27 for more information.		H	0
2	week	GPS reference week number	Long	4	H
3	seconds	Seconds into the week as measured from the receiver clock, coincident with the time of electrical closure on the Mark Input port	Double	8	H+4
4	offset	Receiver clock offset, in seconds. A positive offset implies that the receiver clock is ahead of GPS system time. To derive GPS system time, use the following formula: GPS system time = GPS reference time - (offset) Where GPS reference time can be obtained from the log header	Double	8	H+12
5	offset std	Standard deviation of receiver clock offset (s)	Double	8	H+20
6	utc offset	This field represents the offset of GPS system time from UTC time (s), computed using almanac parameters. UTC time is GPS reference time plus the current UTC offset minus the receiver clock offset. UTC time = GPS reference time - offset + UTC offset <div style="border: 1px solid black; padding: 5px; margin-top: 10px;"> 0 indicates that UTC time is unknown because there is no almanac available in order to acquire the UTC offset. </div>	Double	8	H+28

Field	Field type	Description	Format	Binary Bytes	Binary Offset
7	status	Clock model status, see <i>Table 78: Clock Model Status</i> on page 400	Enum	4	H+36
8	xxxx	32-bit CRC (ASCII and Binary only)	Ulong	4	H+40
9	[CR][LF]	Sentence terminator (ASCII only)	-	-	-

3.80 MASTERPOS

Master Position using ALIGN

Platform: OEM719, OEM729, OEM7500, OEM7600, OEM7700, OEM7720, PwrPak7, SPAN CPT7, SMART7

ALIGN generates distance and bearing information between a Master and Rover receiver. This log outputs the position information of the master when using the ALIGN feature. This log can be output from both Y and Z ALIGN models and can be output at both Master and Rover ends.



You must have an ALIGN capable receiver to use this log.



1. ALIGN is useful for obtaining the relative directional heading of a vessel/body, separation heading between two vessels/bodies or heading information with moving base and pointing applications.
2. The log can be output at both Y and Z model Rover if it is receiving the RTCAREFEXT or NovAtelXRef message from the Master. The log can be output at any Master if the Master is receiving HEADINGEXTB or HEADINGEXT2B from the Rover. Refer to the NovAtel application note [APN-048](#) for details on HEADINGEXT (available on our website at www.novatel.com/support/.)
3. MASTERPOS logging is dictated by the output frequency of the RTCAREFEXT or NovAtelXRef output frequency.

Message ID: 1051

Log Type: Asynch

Recommended Input:

```
log masterposa onchanged
```

ASCII Example:

```
#MASTERPOSA,COM1,0,21.5,FINESTEERING,1544,340322.000,02000008,5009,4655;  
SOL_COMPUTED,NARROW_INT,51.11604599076,-114.03855412002,1055.7756,16.9000,  
WGS84,0.0090,0.0086,0.0143,"AAAA",0.0,0.0,13,13,13,12,0,0,0,0*a72e8d3f
```



Asynchronous logs, such as MASTERPOS, should only be logged ONCHANGED or ONNEW otherwise, the most current data is not output when it is available. This is especially true of the ONTIME trigger, which may cause inaccurate time tags to result.

Field	Field Type	Description	Format	Binary Bytes	Binary Offset
1	MASTERPOS header	Log header. See <i>Messages</i> on page 27 for more information.		H	0

Field	Field Type	Description	Format	Binary Bytes	Binary Offset
2	sol stat	Solution Status, see <i>Table 65: Solution Status</i> on page 374	Enum	4	H
3	pos type	Position Type see <i>Table 66: Position or Velocity Type</i> on page 375	Enum	4	H+4
4	lat	Master WGS84 Latitude in degrees	Double	8	H+8
5	long	Master WGS84 Longitude in degrees	Double	8	H+16
6	hgt	Master MSL Height in meters	Double	8	H+24
7	undulation	Undulation in meters	Float	4	H+32
8	datum id#	Datum ID number 61 = WGS84 63 = USER (default = WGS84)	Enum	4	H+36
9	lat σ	Latitude standard deviation in meters	Float	4	H+40
10	long σ	Longitude standard deviation in meters	Float	4	H+44
11	hgt σ	Height standard deviation in meters	Float	4	H+48
12	stn id	Receiver ID can be set using the DGPSTXID command (see page 105)	Char[4]	4	H+52
13	Reserved		Float	4	H+56
14			Float	4	H+60
15	#SVs	Number of satellite vehicles tracked	Uchar	1	H+64
16	#solnSVs	Number of satellite vehicles used in solution	Uchar	1	H+65
17	#obs	Number of satellites with L1/E1/B1 signals used in solution	Uchar	1	H+66
18	#multi	Number of satellites with multi-frequency signals used in solution	Uchar	1	H+67
19	sol source	Solution source (see <i>Table 92: Solution Source</i> on page 471)	Hex	1	H+68
20	Reserved		Uchar	1	H+69
21			Uchar	1	H+70
22			Uchar	1	H+71
23	xxxx	32-bit CRC (ASCII and Binary only)	HEX	1	H+72
24	[CR][LF]	Sentence Terminator (ASCII only)	-	-	-

3.81 MATCHEDPOS

Matched RTK position

Platform: OEM719, OEM729, OEM7500, OEM7600, OEM7700, OEM7720, PwrPak7, SPAN CPT7, SMART7

This log represents positions that have been computed from time matched base and rover observations. There is no base extrapolation error on these positions because they are based on buffered measurements, that is, they lag real time by some amount depending on the latency of the data link. If the rover receiver has not been enabled to accept RTK differential data or is not actually receiving data leading to a valid solution, this is shown in fields #2 (*sol status*) and #3 (*pos type*).

This log provides the best accuracy in static operation. For lower latency in kinematic operation, see the **RTKPOS** log (see page 674) or **BESTPOS** log (see page 371). The data in the logs changes only when a base observation (RTCMv3) changes.

A good message trigger for this log is onchanged. Then, only positions related to unique base station messages are produced and the existence of this log indicates a successful link to the base.



Asynchronous logs, such as MATCHEDPOS, should only be logged ONCHANGED otherwise the most current data is not output when it is available. This is especially true of the ONTIME trigger, which may cause inaccurate time tags to result.



The RTK system in the receiver provides two kinds of position solutions. The Matched RTK position is computed with buffered observations, so there is no error due to the extrapolation of base station measurements. This provides the highest accuracy solution possible at the expense of some latency which is affected primarily by the speed of the differential data link. The **MATCHEDPOS** log contains the matched RTK solution and can be generated for each processed set of base station observations.

The Low-Latency RTK position is computed from the latest local observations and extrapolated base station observations. This supplies a valid RTK position with the lowest latency possible at the expense of some accuracy. The degradation in accuracy is reflected in the standard deviation and is summarized in [An Introduction to GNSS](#) available on our website. The amount of time that the base station observations are extrapolated is in the "differential age" field of the position log. The Low-Latency RTK system extrapolates for 60 seconds. The **RTKPOS** log (see page 674) contains the Low-Latency RTK position when valid, and an "invalid" status when a Low-Latency RTK solution could not be computed. The **BESTPOS** log (see page 371) contains either the low-latency RTK, PPP or pseudorange-based position, whichever has the smallest standard deviation.

Message ID: 96

Log Type: Asynch

Recommended Input:

```
log matchedposa onchanged
```

ASCII Example:

```
#MATCHEDPOSA,COM1,0,63.0,FINESTEERING,1419,340034.000,02000040,2f06,2724;
SOL_COMPUTED,NARROW_INT,51.11635908660,-114.03833102484,1063.8400,-16.2712,
WGS84,0.0140,0.0075,0.0174,"AAAA",0.000,0.000,12,12,12,12,0,01,0,33*feac3a3a
```



Measurement precision is different from the position computation precision. Measurement precision is a value that shows how accurately the actual code or carrier phase is measured by the GNSS receiver. Position precision is a value that shows the accuracy of the position computation made from the code and/or carrier phase measurements. The P-code L2 measurement precision is not as good as the C/A measurement precision because the NovAtel GNSS receiver is a civilian grade GPS device and does not have direct access to the decrypted military L2 P(Y) code. This means that NovAtel's semi-codeless P-code L2 measurements are noisier than the civilian band C/A code measurements. Refer to the [SMART7 Installation and Operation User Manual](#) for the technical specification of the OEM7 card.

Field	Field type	Description	Format	Binary Bytes	Binary Offset
1	MATCHEDPOS header	Log header. See <i>Messages</i> on page 27 for more information.		H	0
2	sol status	Solution status (see <i>Table 65: Solution Status</i> on page 374)	Enum	4	H
3	pos type	Position type (see <i>Table 66: Position or Velocity Type</i> on page 375)	Enum	4	H+4
4	lat	Latitude (degrees)	Double	8	H+8
5	lon	Longitude (degrees)	Double	8	H+16
6	hgt	Height above mean sea level (m)	Double	8	H+24
7	undulation	Undulation - the relationship between the geoid and the WGS84 ellipsoid (m) <div style="border: 1px solid black; padding: 5px; width: fit-content; margin: 10px auto;"> When using a datum other than WGS84, the undulation value also includes the vertical shift due to differences between the datum in use and WGS84. </div>	Float	4	H+32
8	datum id#	Datum ID number 61 = WGS84 63 = USER	Enum	4	H+36
9	lat σ	Latitude standard deviation (m)	Float	4	H+40
10	lon σ	Longitude standard deviation (m)	Float	4	H+44

Field	Field type	Description	Format	Binary Bytes	Binary Offset
11	hgt σ	Height standard deviation (m)	Float	4	H+48
12	stn id	Base station ID	Char[4]	4	H+52
13	Reserved		Float	4	H+56
14			Float	4	H+60
15	#SVs	Number of satellites tracked	Uchar	1	H+64
16	#solnSVs	Number of satellite vehicles used in solution	Uchar	1	H+65
17	#ggL1	Number of satellites with L1/E1/B1 signals used in solution	Uchar	1	H+66
18	#solnMultiSVs	Number of satellites with multi-frequency signals used in solution	Uchar	1	H+67
19	Reserved		Hex	1	H+68
20	ext sol stat	Extended solution status (see <i>Table 69: Extended Solution Status</i> on page 378)	Hex	1	H+69
21	Galileo and BeiDou sig mask	Galileo and BeiDou signals used mask (see <i>Table 68: Galileo and BeiDou Signal-Used Mask</i> on page 378)	Hex	1	H+70
22	GPS and GLONASS sig mask	GPS and GLONASS signals used mask (see <i>Table 67: GPS and GLONASS Signal-Used Mask</i> on page 377)	Hex	1	H+71
23	xxxx	32-bit CRC (ASCII and Binary only)	Hex	4	H+72
24	[CR][LF]	Sentence terminator (ASCII only)	-	-	-

3.82 MATCHEDSATS

Satellites used in MATCHEDPOS solution

Platform: OEM719, OEM729, OEM7500, OEM7600, OEM7700, OEM7720, PwrPak7, SPAN CPT7, SMART7

This log lists the used and unused satellites for the corresponding MATCHEDPOS solution. It also describes the signals of the used satellites and reasons for exclusions.

Message ID: 1176

Log Type: Asynch

Recommended Input:

```
log matchedsats unchanged
```

Abbreviated ASCII Example:

```
<MATCHEDSATS COM1 0 60.5 FINESTEERING 1728 524924.000 02000000 b555 11487
<    24
<      GPS 3 GOOD 00000003
<      GPS 5 GOOD 00000003
...
<      GPS 23 GOOD 00000003
<      GPS 30 GOOD 00000003
<      GLONASS 1+1 GOOD 00000003
<      GLONASS 2-4 GOOD 00000003
...
<      GLONASS 21+4 GOOD 00000003
<      BEIDOU 6 GOOD 00000003
<      BEIDOU 11 GOOD 00000003
...
<      BEIDOU 12 GOOD 00000003
<      BEIDOU 13 GOOD 00000003
```

Field	Field type	Description	Format	Binary Bytes	Binary Offset
1	MATCHEDSATS header	Log header. See <i>Messages</i> on page 27 for more information.		H	0
2	#entries	Number of records to follow	Ulong	4	H
3	system	See <i>Table 93: Satellite System</i> on page 477	Enum	4	H+4
4	Satellite ID	Satellite identifier	Ulong	4	H+8
5	Status	Satellite status (<i>Table 71: Observation Statuses</i> on page 381)	Enum	4	H+12

Field	Field type	Description	Format	Binary Bytes	Binary Offset
6	Signal mask	See Table 72: <i>BESTSATS GPS Signal Mask</i> on page 382, Table 73: <i>BESTSATS GLONASS Signal Mask</i> on page 383, Table 74: <i>BESTSATS Galileo Signal Mask</i> on page 383, and Table 75: <i>BESTSATS BeiDou Signal Mask</i> on page 383	Hex	4	H+16
7	Next satellite offset = H + 4 + (#sat x 16)				
8	xxxx	32-bit CRC (ASCII and Binary only)	Hex	1	H+4+ (#sat x 16)
9	[CR][LF]	Sentence terminator (ASCII only)	-	-	-

3.83 MATCHEDXYZ

Matched RTK Cartesian position

Platform: OEM719, OEM729, OEM7500, OEM7600, OEM7700, OEM7720, PwrPak7, SPAN CPT7, SMART7

This log contains the receiver's matched position in ECEF coordinates. It represents positions that have been computed from time matched base and rover observations. There is no base station extrapolation error on these positions because they are based on buffered measurements, that is, they lag real time, by some amount, depending on the latency of the data link. If the rover receiver has not been enabled to accept RTK differential data or is not actually receiving data leading to a valid solution, this is reflected by the code shown in field #2 (solution status) and #3 (position type). See *Figure 6: The WGS84 ECEF Coordinate System* on page 392 for a definition of the ECEF coordinates.

This log provides the best accuracy in static operation. For lower latency in kinematic operation, see the **BESTXYZ** log (see page 390) or **RTKXYZ** log (see page 681). The data in the logs changes only when a base observation (RTCMv3) changes.

The time stamp in the header is the time of the matched observations that the computed position is based on and not the current time.

Message ID: 242

Log Type: Asynch

Recommended Input:

log matchedxyza onchanged



Asynchronous logs, such as MATCHEDXYZ, should only be logged ONCHANGED otherwise the most current data is not output when it is available. This is especially true of the ONTIME trigger, which may cause inaccurate time tags to result.

ASCII Example:

```
#MATCHEDXYZA,COM1,0,62.5,FINESTEERING,1419,340035.000,02000040,b8ed,2724;
SOL_COMPUTED,NARROW_INT,-1634531.5703,-3664618.0321,4942496.3280,0.0080,0.0159,
0.0154,"AAAA",12,12,12,12,0,01,0,33*e4b84015
```

Field	Field type	Description	Format	Binary Bytes	Binary Offset
1	MATCHEDXYZ header	Log header. See <i>Messages</i> on page 27 for more information.		H	0
2	P-sol status	Solution status, see <i>Table 65: Solution Status</i> on page 374	Enum	4	H
3	pos type	Position type, see <i>Table 66: Position or Velocity Type</i> on page 375	Enum	4	H+4
4	P-X	Position X-coordinate (m)	Double	8	H+8

Field	Field type	Description	Format	Binary Bytes	Binary Offset
5	P-Y	Position Y-coordinate (m)	Double	8	H+16
6	P-Z	Position Z-coordinate (m)	Double	8	H+24
7	P-X σ	Standard deviation of P-X (m)	Float	4	H+32
8	P-Y σ	Standard deviation of P-Y (m)	Float	4	H+36
9	P-Z σ	Standard deviation of P-Z (m)	Float	4	H+40
10	stn ID	Base station ID	Char[4]	4	H+44
11	#SVs	Number of satellites tracked	Uchar	1	H+48
12	#solnSVs	Number of satellite vehicles used in solution	Uchar	1	H+49
13	#ggL1	Number of satellites with L1/E1/B1 signals used in solution	Uchar	1	H+50
14	#solnMultiSVs	Number of satellites with multi-frequency signals used in solution	Uchar	1	H+51
15	Reserved		Char	1	H+52
16	ext sol stat	Extended solution status (see <i>Table 69: Extended Solution Status</i> on page 378)	Hex	1	H+53
17	Galileo and BeiDou sig mask	Galileo and BeiDou signals used mask (see <i>Table 68: Galileo and BeiDou Signal-Used Mask</i> on page 378)	Hex	1	H+54
18	GPS and GLONASS sig mask	GPS and GLONASS signals used mask (see <i>Table 67: GPS and GLONASS Signal-Used Mask</i> on page 377)	Hex	1	H+55
19	xxxx	32-bit CRC (ASCII and Binary only)	Hex	4	H+56
20	[CR][LF]	Sentence terminator (ASCII only)	-	-	-

3.84 MODELFEATURES

States features available for current loaded model

Platform: OEM719, OEM729, OEM7500, OEM7600, OEM7700, OEM7720, PwrPak7, SPAN CPT7, SMART7, SMART2

The MODELFEATURES log states the features available for the current loaded model.

To see which satellite systems are available for the current model, use the **CHANCONFIGLIST** log (see page 395).

Most features have a boolean state: authorized or unauthorized. However, some have more complex licensed states with varying degrees of capability.



This log is best viewed in Abbreviated ASCII.

Message ID: 1329

Log Type: Polled

Recommended Input:

```
log modelfeatures once
```

Abbreviated ASCII Example:

```
<MODELFEATURES COM1 0 92.5 COARSESTEERING 2007 237316.648 02400000 141a 14898
<      20
<      1HZ MAX_MSR_RATE
<      0HZ MAX_POS_RATE
<      SINGLE ANTENNA
<      AUTHORIZED NTRIP
<      UNAUTHORIZED IMU
<      UNAUTHORIZED INS
<      UNAUTHORIZED MEAS_OUTPUT
<      UNAUTHORIZED DGPS_TX
<      UNAUTHORIZED RTK_TX
<      UNAUTHORIZED RTK_FLOAT
<      UNAUTHORIZED RTK_FIXED
<      UNAUTHORIZED PPP
<      UNAUTHORIZED LOW_END_POSITIONING
<      UNAUTHORIZED RAIM
<      UNAUTHORIZED ALIGN_HEADING
<      UNAUTHORIZED ALIGN_RELATIVE_POS
<      UNAUTHORIZED API
<      UNAUTHORIZED INTERFERENCE_MITIGATION
<      UNAUTHORIZED RTKASSIST
<      UNAUTHORIZED SCINTILLATION
```

Field	Field type	Description	Format	Binary Bytes	Binary Offset
1	MODELFEATURES header	Log header. See <i>Messages</i> on page 27 for more information.	-	H	0
2	# Feature	Number of features in list	Ulong	4	H
3	Feature Status	Licensing status of feature See <i>Table 104: Feature Status</i> below	Enum	4	H+4
4	Feature Type	Type of feature See <i>Table 105: Feature Type</i> on the next page	Enum	4	H+8
5...	Next feature = H+4+(# Feature x 8)				
6	xxxx	32-bit CRC (ASCII and Binary only)	Ulong	4	H+4+(# Feature x 8)
7	[CR][LF]	Sentence terminator (ASCII only)	-	-	-

Table 104: Feature Status

Value	Name	Description
0	AUTHORIZED	The feature is authorized
1	UNAUTHORIZED	The feature is unauthorized
2	0Hz	Disables output of POS logs
6	20Hz	Maximum logging rate for POS or MSR logs is 20 Hz
8	100Hz	Maximum logging rate for POS or MSR logs is 100 Hz
9	RATE_INVALID	Option bits don't correspond to a valid rate
15	STANDARD	SPAN Standard Model
20	COMMERCIAL_MEMS	IMU Grade-Commercial MEMS
21	TACTICAL	IMU Grade-Tactical
22	HIGH_GRADE_TACTICAL	IMU Grade-High Grade Tactical
23	NAVIGATION	IMU Grade-Navigation
25	SINGLE	Single antenna
26	DUAL	Dual antenna
30	LITE	SPAN Lite Model
33	CONSUMER_MEMS	IMU Grade-Consumer MEMS

Table 105: Feature Type

Value	Name	Description
0	MAX_MSR_RATE	Maximum measurement logging rate
1	MAX_POS_RATE	Maximum position logging rate
3	MEAS_OUTPUT	Output of raw measurements (phase and pseudorange)
4	DGPS_TX	Transmission of DGPS (non RTK) corrections
5	RTK_TX	Transmission of RTK corrections
6	RTK_FLOAT	RTK float positioning
7	RTK_FIXED	RTK fixed positioning
8	RAIM	Extended RAIM
9	LOW_END_POSITIONING	GLIDE and TerraStar-L positioning
10	ALIGN_HEADING	Heading
11	ALIGN_RELATIVE_POS	Heading and Relative Positioning
12	API	Lua Scripted User Interface (formerly User Application API)
15	NTRIP	NTRIP Server/Client
19	PPP	TerraStar-C, TerraStar-C PRO, or TerraStar-X positioning
20	SCINTILLATION	Scintillation
22	INS	Inertial (SPAN)
23	IMU	IMU Grade
26	FEATURE_INTERFERENCE_MITIGATION	Interference Mitigation
28	ANTENNA	Number of antenna enabled on the receiver
29	GENERIC_IMU	SPAN Generic IMU Interface
30	INS_PLUS_PROFILES	SPAN Plus Profiles
31	HEAVE	SPAN Heave Option
32	RELATIVE_INS	SPAN Relative INS
999	MODEL_INVALID	If a bad model is loaded, MODELFEATURES will contain one entry: MODEL_INVALID STATUS_INVALID

3.85 NAVICALMANAC

Decoded NavIC Almanac

Platform: OEM719, OEM729, OEM7500, OEM7600, OEM7700, OEM7720, PwrPak7, SPAN CPT7, SMART7

This log contains the decoded NavIC almanac parameters from NavIC navigation messages. Multiple messages are transmitted, one for each satellite ID with data.

The OEM7 family of receivers automatically save almanacs in their Non-Volatile Memory (NVM), so creating an almanac boot file is not necessary.

Message ID: 2122

Log Type: Asynch

Recommended Input:

log navicalmanaca onchanged

ASCII Example:

```
#NAVICALMANACA,COM1,4,69.5,SATTIME,1943,158160.000,02000020,fb6e,32768;919,
0.001982212,86400,0.075264303,8.457495146e-10,6493.383789062,1.327344662,
2.996060720,2.542881375,-0.000580788,7.275957614e-12,6,0,0,5*05cfbc62

#NAVICALMANACA,COM1,3,69.5,SATTIME,1943,156276.000,02000020,fb6e,32768;919,
0.001962662,0,0.509411950,2.742971399e-10,6493.538574219,1.844826864,
3.107479183,-3.001633760,-0.000161171,-5.093170330e-11,4,0,0,7*8fbd9e3a

#NAVICALMANACA,COM1,2,69.5,SATTIME,1943,158148.000,02000020,fb6e,32768;919,
0.001979351,86400,0.499982612,2.400099974e-10,6493.359375000,-1.300198895,
-3.061969089,0.047002130,0.000025749,-3.637978807e-12,5,0,0,5*be12ffa2

#NAVICALMANACA,COM1,1,69.5,SATTIME,1943,157620.000,02000020,fb6e,32768;919,
0.001854897,86400,0.509561753,1.371485699e-10,6493.388671875,1.842267109,
3.032190537,2.385950946,0.000114441,-5.456968211e-11,2,0,0,5*b64cf69c

#NAVICALMANACA,COM1,0,69.5,SATTIME,1943,156804.000,02000020,fb6e,32768;919,
0.000161171,86400,0.076541746,1.142904749e-09,6493.613281250,1.349937548,
0.783248119,0.142653098,0.000204086,-8.003553376e-11,7,0,0,7*495808b9
```



The speed at which the receiver locates and locks onto new satellites is improved if the receiver has approximate time and position (**SETAPPROXTIME** and **SETAPPROXPOS**), as well as an almanac. This allows the receiver to compute the elevation of each satellite so it can tell which satellites are visible and their Doppler offsets, improving Time to First Fix (TTFF).

Field	Field Type	Description	Format	Binary Bytes	Binary Offset
1	NAVICALMANAC header	Log header. See <i>Messages</i> on page 27 for more information.	-	H	0

Field	Field Type	Description	Format	Binary Bytes	Binary Offset
2	WNa	Week number for the almanac since the NavIC system time start epoch (August 22nd 1999)	Ulong	4	H
3	Ecc	Eccentricity (dimensionless)	Double	8	H+4
4	Toa	Time of Almanac (s)	Ulong	4	H+12
5	I0	Inclination angle (radians)	Double	8	H+16
6	OmegaDot	Rate of RAAN (radians/s)	Double	8	H+24
7	RootA	Square root of semi-major axis (sqrt(m))	Double	8	H+32
8	Omega0	Longitude of ascending node (radians)	Double	8	H+40
9	Omega	Argument of perigee (radians)	Double	8	H+48
10	M0	Mean Anomaly (radians)	Double	8	H+56
11	Af0	Clock bias A0 (s)	Double	8	H+64
12	Af1	Clock Drift A1 (s/s)	Double	8	H+72
13	AlmSVID	PRN ID for Almanac	Ulong	4	H+80
14	InterSigCorr	Inter Signal Correction (s)	Ulong	4	H+84
15	Spare		Ulong	4	H+88
16	PRN	Transmitting Satellite Identifier	Ulong	4	H+92
17	xxxx	32-bit CRC (ASCII and Binary only)	Hex	4	H+96
18	[CR][LF]	Sentence terminator (ASCII only)	-	-	-

3.86 NAVICEPHEMERIS

Decoded NavIC Ephemeris

Platform: OEM719, OEM729, OEM7500, OEM7600, OEM7700, OEM7720, PwrPak7, SPAN CPT7, SMART7

This log contains NavIC ephemeris parameters with the appropriate scaling applied. Multiple messages are transmitted, one for each SV ephemeris collected.

Message ID: 2123

Log Type: Asynch

Recommended Input:

```
log navicephemerisa onchanged
```

ASCII Example:

```
#NAVICEPHEMERISA, COM1, 5, 74.0, SATTIME, 1943, 255984.000, 02000020, 01fa, 32768; 2, 919,
1.05838757e-04, -5.63886715e-11, 0.00000000, 0, 252000, -1.86e-09, 3.2829938927e-09,
11, 0, 0, 0, 1.922249794e-06, 1.032650471e-05, 2.011656761e-07, 4.097819328e-08,
-230.9375000, 66.1250000, -5.239503961e-10, 0, 1.900019163, 252000, 1.8492219970e-03,
6493.385761, 1.842761896e+00, 3.027013584, -2.94012247e-09, 5.0965660552e-01,
0, 0, 0*d2f4c9a5
```

```
#NAVICEPHEMERISA, COM1, 4, 74.0, SATTIME, 1943, 255984.000, 02000020, 01fa, 32768; 6, 919,
-5.79587650e-04, 1.02318154e-11, 0.00000000, 1, 252000, -1.86e-09, 8.5817860373e-09,
11, 0, 0, 0, -1.282989979e-05, 2.417713404e-06, 1.974403858e-07, 2.644956112e-07,
-83.3125000, -395.3125000, -5.535944880e-10, 0, 2.050709297, 252000,
1.9699299010e-03, 6493.408867, 1.328589850e+00, 2.996532035, -7.66746224e-09,
7.5298187077e-02, 0, 0, 0*50cdb388
```

...

```
#NAVICEPHEMERISA, COM1, 0, 74.0, SATTIME, 1943, 255984.000, 02000020, 01fa, 32768; 7, 919,
1.90386083e-04, -8.28777047e-11, 0.00000000, 1, 255024, -1.40e-09, 6.3988379659e-09,
252, 0, 0, 0, -8.992850780e-06, -1.732259989e-06, -9.313225746e-08, -2.235174179e-08,
60.1250000, -266.1875000, -3.928735076e-10, 0, -0.445949980, 255024,
2.4348858278e-04, 6493.269802, 1.351327715e+00, 1.099632488, -5.54308803e-09,
7.6573741924e-02, 0, 0, 0*01bf330e
```

Field	Field Type	Description	Format	Binary Bytes	Binary Offset
1	NAVICEPHEMERIS header	Log header. See <i>Messages</i> on page 27 for more information.	-	H	0
2	PRN	Satellite Identifier	Ulong	4	H
3	WN	Week number since the NavIC system time start epoch (August 22nd 1999)	Ulong	4	H+4
4	Af0	Clock bias (s)	Double	8	H+8

Field	Field Type	Description	Format	Binary Bytes	Binary Offset
5	Af1	Clock drift (s/s)	Double	8	H+16
6	Af2	Clock drift rate (s/s ²)	Double	8	H+24
7	URA	SV Accuracy	Ulong	4	H+32
8	toc	Reference time for the satellite clock corrections (s)	Ulong	4	H+36
9	TGD	Total group delay (s)	Double	8	H+40
10	DeltaN	Mean motion difference (radian/s)	Double	8	H+48
11	IODEC	Issue of data ephemeris and clock	Ulong	4	H+56
12	Reserved		Ulong	4	H+60
13	L5 Health	Health status of navigation data on L5 SPS signal 0=OK; 1=bad	Ulong	4	H+64
14	S Health	Health status of navigation data on S SPS signal 0=OK; 1=bad	Ulong	4	H+68
15	Cuc	Amplitude of the cosine harmonic correction term to the argument of latitude (radians)	Double	8	H+72
16	Cus	Amplitude of the sine harmonic correction term to the argument of latitude (radians)	Double	8	H+80
17	Cic	Amplitude of the cosine harmonic correction term to the angle of inclination (radians)	Double	8	H+88
18	Cis	Amplitude of the sine harmonic correction term to the angle of inclination (radians)	Double	8	H+96
19	Crc	Amplitude of the cosine harmonic correction term to the orbit radius (m)	Double	8	H+104
20	Crs	Amplitude of the sine harmonic correction term to the orbit radius (m)	Double	8	H+112
21	IDOT	Rate of inclination angle (radians/s)	Double	8	H+120
22	Spare		Ulong	4	H+128
23	M0	Mean anomaly (radians)	Double	8	H+132

Field	Field Type	Description	Format	Binary Bytes	Binary Offset
24	toe	Time of ephemeris (s)	Ulong	4	H+140
25	Ecc	Eccentricity (dimensionless)	Double	8	H+144
26	RootA	Square root of semi-major axis (sqrt (m))	Double	8	H+152
27	Omega0	Longitude of ascending node (radians)	Double	8	H+160
28	Omega	Argument of perigee (radians)	Double	8	H+168
29	OmegaDot	Rate of RAAN (radians/s)	Double	8	H+176
30	I0	Inclination angle (radians)	Double	8	H+184
31	Spare		Ulong	4	H+192
32	Alert flag	The utilization of navigation data shall be at the users' own risk. 1=Alert; 0=OK	Ulong	4	H+196
33	AutoNav flag	When set to 1, satellite is in AutoNav mode. Satellite broadcasts primary navigation parameters from AutoNav data sets with no uplink from ground for maximum of 7 days	Ulong	4	H+200
34	xxxx	32-bit CRC (ASCII and Binary only)	Hex	4	H+204
35	[CR][LF]	Sentence terminator (ASCII only)	-	-	-

3.87 NAVICIONO

NavIC ionospheric coefficients parameters

Platform: OEM719, OEM729, OEM7500, OEM7600, OEM7700, OEM7720, PwrPak7, SPAN CPT7, SMART7

This log contains NavIC ionospheric coefficients parameters. Ionospheric error correction for single frequency (L5) users of the NavIC are provided through a set of eight coefficients. The correction coefficients are:

- 4 Alpha Coefficients (a_n ; $n=0,1,2,3$)

These are the coefficients of the cubic polynomial representing the amplitude of the positive cosine curve in the cosine model approximation of ionospheric delay.

- 4 Beta Coefficients (β_n ; $n=0,1,2,3$)

These are the coefficients of the cubic polynomial representing the period of the positive cosine curve in the cosine model approximation of ionospheric delay.

Message ID: 2124

Log Type: Asynch

Recommended Input:

```
log navicionoa onchanged
```

ASCII Example:

```
#NAVICIONOA,COM1,0,92.5,SATTIME,1944,166272.000,02000020,56c0,32768;  
5,2.980232238769531e-08,3.874301910400390e-07,-2.562999725341796e-06,  
-7.510185241699216e-06,558.0,168.0,-2286.0,2286.0,0*2b250bbd
```

Field	Field Type	Description	Format	Binary Bytes	Binary Offset
1	NAVICIONO header	Log header. See <i>Messages</i> on page 27 for more information.	-	H	0
2	PRN	Satellite Identifier of the transmitting NavIC SV	Ulong	4	H
3	Alpha 0	Alpha parameter constant term	Double	8	H+4
4	Alpha 1	Alpha parameter 1st order term	Double	8	H+12
5	Alpha 2	Alpha parameter 2nd order term	Double	8	H+20
6	Alpha 3	Alpha parameter 3rd order term	Double	8	H+28
7	Beta 0	Beta parameter constant term	Double	8	H+36
8	Beta 1	Beta parameter 1st order term	Double	8	H+44
9	Beta 2	Beta parameter 2nd order term	Double	8	H+52
10	Beta 3	Beta parameter 3rd order term	Double	8	H+60

Field	Field Type	Description	Format	Binary Bytes	Binary Offset
11	Spare		Ulong	4	H+68
12	xxxx	32-bit CRC (ASCII and Binary only)	Hex	4	H+72
13	[CR][LF]	Sentence terminator (ASCII only)	-	-	-

3.88 NAVICRAWSUBFRAME

Raw NavIC subframe data

Platform: OEM719, OEM729, OEM7500, OEM7600, OEM7700, OEM7720, PwrPak7, SPAN CPT7, SMART7

This log contains the raw NavIC subframe data with parity bits removed. Only subframes that have passed the parity check are output.

Message ID: 2105

Log Type: Asynch

Recommended Input:

```
log navicrawsubframea onchanged
```

ASCII Example:

```
#NAVICRAWSUBFRAMEA,COM1,0,72.5,SATTIME,1943,159168.000,02000020,76af,32768;182,7,1,8b19e883971a005bf4880009ab3f400eac0af84f7541befff78018e6d7e1dfacd1*88c2ba19
#NAVICRAWSUBFRAMEA,COM1,0,72.5,SATTIME,1943,159168.000,02000020,76af,32768;177,2,1,8b19e883970e8fc3f8500009ab3f00087f0af8415e4232800f7fd9eb8650b7b630*c7e27e82
#NAVICRAWSUBFRAMEA,COM1,0,72.5,SATTIME,1943,159168.000,02000020,76af,32768;181,6,1,8b19e88397b3e73401600009ab3f0012370af84f550327c032800ad1d9da339260*0bb7b256
#NAVICRAWSUBFRAMEA,COM1,0,72.5,SATTIME,1943,159168.000,02000020,76af,32768;180,5,1,8b19e88397036703ff1c0049ab3fc009b10af84fe7e3773ffd7fd6d8f5fddc4181*f42f59ab
```

Field	Field Type	Description	Format	Binary Bytes	Binary Offset
1	NAVICRAWSUBFRAME header	Log header. See <i>Messages</i> on page 27 for more information.	-	H	0
2	Signal channel	Signal channel providing the data	Ulong	4	H
3	PRN	Satellite Identifier of transmitting NavIC SV	Ulong	4	H+4
4	Subframe Id	Subframe ID	Ulong	4	H+8
5	Raw subframe data	Raw subframe data (262 bits). Does not include CRC or Tail bits	Hex[33]	33	H+12
6	xxxx	32-bit CRC (ASCII and Binary only)	Hex	4	H+45
7	[CR][LF]	Sentence terminator (ASCII only)	-	-	-

3.89 NAVICSYSCLOCK

NavIC clock parameters

Platform: OEM719, OEM729, OEM7500, OEM7600, OEM7700, OEM7720, PwrPak7, SPAN CPT7, SMART7

This log provides the NavIC system time offset with respect to UTC, UTC (NPLI) and other GNSS times such as GPS, GALILEO, GLONASS.

Message ID: 2125

Log Type: Asynch

Recommended Input:

```
log navicsysclocka onchanged
```

ASCII Example:

```
#NAVICSYSCLOCKA,COM1,0,93.0,SATTIME,1944,166320.000,02000020,3dfd,32768;7,
-7.625203579664230e-09,-1.598721155460225e-14,0.000000000000000e+00,18,32508,
920,905,7,18,2,2.149608917534351e-07,-5.151434834260726e-14,
-1.998997755520149e-19,32508,920,0*f6617e67
```

Field	Field Type	Description	Format	Binary Bytes	Binary Offset
1	NAVICSYSCLOCK header	Log header. See <i>Messages</i> on page 27 for more information.		H	0
2	PRN	Satellite Identifier of the transmitting NavIC SV	Ulong	4	H
3	A0 _{utc}	Bias coefficient of the NavIC time scale relative to the UTC time scale (s)	Double	8	H+4
4	A1 _{utc}	Drift coefficient of the NavIC time scale relative to the UTC time scale (s/s)	Double	8	H+12
5	A2 _{utc}	Drift rate coefficient of the NavIC time scale relative to the UTC time scale (s/s ²)	Double	8	H+20
6	Δt_{LS}	Current or past leap second count (s)	Long	4	H+28
7	T _{outc}	Time data reference time of week (s)	Ulong	4	H+32
8	WN _{outc}	Time data reference week number	Ulong	4	H+36
9	WN _{LSF}	Leap second reference week number	Ulong	4	H+40
10	DN	Leap second reference day number	Ulong	4	H+44
11	Δt_{LSF}	Current or future leap second count (s)	Long	4	H+48

Field	Field Type	Description	Format	Binary Bytes	Binary Offset
12	GNSSID	Timescale for the time offsets with respect to NavIC (<i>Table 106: GNSS Time Scales</i> below)	Ulong	4	H+52
13	A0	Bias coefficient of the NavIC time scale relative to the GNSS time scale (s)	Double	8	H+56
14	A1	Drift coefficient of the NavIC time scale relative to the GNSS time scale (s/s)	Double	8	H+64
15	A2	Drift rate correction coefficient of the NavIC time scale relative to the GNSS time scale (s/s ²)	Double	8	H+72
16	Tot	Time data reference time of week (s)	Ulong	4	H+80
17	WNot	Time data reference week number	Ulong	4	H+84
18	Spare		Ulong	4	H+88
19	xxxx	32-bit CRC (ASCII and Binary only)	Hex	4	H+92
20	[CR][LF]	Sentence terminator (ASCII only)	-	-	-

Table 106: GNSS Time Scales

GNSS ID	Time Scale
0	GPS
1	GALILEO
2	GLONASS
3-6	Reserved
7	UTC (NPLI)

3.90 NMEA Standard Logs

Platform: OEM719, OEM729, OEM7500, OEM7600, OEM7700, OEM7720, PwrPak7, SPAN CPT7, SMART7, SMART2

This log contains NMEA logs.

GLMLA	GLONASS Almanac Data
GPALM	Almanac Data
GPGGA	Global Position System Fix Data and Undulation
GPGGALONG	GPS Fix Data, Extra Precision and Undulation
GPGLL	Geographic Position
GPGRS	GPS Range Residuals for Each Satellite
GPGSA	GPS DOP on Active Satellites
GPGST	Estimated Error in Position Solution
GPGSV	GPS Satellites in View
GPHTD	NMEA Heading Log (ALIGN)
GPRMB	Navigation Information
GPRMC	GPS Specific Information
GPVTG	Track Made Good and Ground Speed
GPZDA	UTC Time and Date

The NMEA log structures follow format standards as adopted by the National Marine Electronics Association. The reference document used is "Standard For Interfacing Marine Electronic Devices NMEA 0183 Version 3.01". For further information, refer to the [Standards and References](#) section of our website www.novatel.com/support/. The following table contains excerpts from Table 6 of the NMEA Standard which defines the variables for the NMEA logs. The actual format for each parameter is indicated after the description.



See the Note in the **GPGGA** log (see page 444) that applies to all NMEA logs.



1. Spaces may only be used in variable text fields.
2. A negative sign "-" (HEX 2D) is the first character in a Field if the value is negative. The sign is omitted if the value is positive.
3. All data fields are delimited by a comma (,).
4. Null fields are indicated by no data between two commas (,,). Null fields indicate invalid data or no data available.
5. The NMEA Standard requires that message length be limited to 82 characters.

Field Type	Symbol	Definition
Special Format Fields		

Field Type	Symbol	Definition
Status	A	Single character field: A = Yes, Data Valid, Warning Flag Clear V = No, Data Invalid, Warning Flag Set
Latitude	IIII.II	Fixed/Variable length field: degrees minutes.decimal - 2 fixed digits of degrees, 2 fixed digits of mins and a <i>variable</i> number of digits for decimal-fraction of minutes. Leading zeros always included for degrees and minutes to maintain fixed length. The decimal point and associated decimal-fraction are optional if full resolution is not required
Longitude	yyyyy.yy	Fixed/Variable length field: degrees minutes.decimal - 3 fixed digits of degrees, 2 fixed digits of minutes and a <i>variable</i> number of digits for decimal-fraction of minutes. Leading zeros always included for degrees and minutes to maintain fixed length. The decimal point and associated decimal-fraction are optional if full resolution is not required
Time	hhmmss.ss	Fixed/Variable length field: hours minutes seconds.decimal - 2 fixed digits of hours, 2 fixed digits of minutes, 2 fixed digits of seconds and <i>variable</i> number of digits for decimal-fraction of seconds. Leading zeros always included for hours, minutes and seconds to maintain fixed length. The decimal point and associated decimal-fraction are optional if full resolution is not required.
Defined field		Some fields are specified to contain predefined constants, most often alpha characters. Such a field is indicated in this standard by the presence of one or more valid characters. Excluded from the list of allowable characters are the following which are used to indicate field types within this standard: "A", "a", "c", "hh", "hhmmss.ss", "IIII.II", "x", "yyyyy.yy"
Numeric Value Fields		
Variable numbers	x.x	Variable length integer or floating numeric field. Optional leading and trailing zeros. The decimal point and associated decimal-fraction are optional if full resolution is not required (example: 73.10 = 73.1 = 073.1 = 73)
Fixed HEX field	hh__	Fixed length HEX numbers only, MSB on the left
Information Fields		
Variable text	c--c	Variable length valid character field

Field Type	Symbol	Definition
Fixed alpha field	aa____	Fixed length field of uppercase or lowercase alpha characters
Fixed number field	xx____	Fixed length field of numeric characters
Fixed text field	cc____	Fixed length field of valid characters

3.91 NOVATELXOBS

NovAtel proprietary RTK correction

Platform: OEM719, OEM729, OEM7500, OEM7600, OEM7700, OEM7720, PwrPak7, SPAN CPT7, SMART7

NOVATELX is a combined observation and reference station message used to transmit RTK corrections. This is a proprietary message and supports sending data for all systems.

Message ID: 1618

Log Type: Synch

Recommended Input:

```
log com2 novatelxobs ontime 1
```

To calculate the size of the NOVATELXOBS messages, use the following formula.

$$\text{Size} = 168 + s * (6 + p * (54 + f*33))$$

where:

s = number of systems (maximum 8)

p = number of PRN per system (maximum 64)

f = number of signals data per PRN – 1 (maximum 10 signals possible)

Example size calculations:

- For 2 systems (GPS and GLONASS), 12 PRN per system, and 2 signals per satellite (L1CA, L2PY)
 - Size = $168 + 2 * (6 + 12 * (54 + 33))$
 - = 2268 bits per second
 - = 284 bytes + NovAtelXHeader (8 bytes)
- For 3 systems (GPS, BEIDOU and GLONASS), 12 PRN per system, and 2 signals per satellite (L1CA, L2PY)
 - Size = $168 + 3 * (6 + 12 * (54 + 33))$
 - = 3318 bits per second
 - = 415 bytes + NovAtelXHeader (8 bytes)
- For 3 systems (GPS, BEIDOU and GLONASS), 12 PRN per system, and 3 signals per satellite (L1CA, L2PY, L2C)
 - Size = $168 + 3 * (6 + 12 * (54 + 2*33))$
 - = 4506 bits per second
 - = 564 bytes + NovAtelXHeader (8 bytes)

3.92 NOVATELXREF

NovAtel proprietary reference station message for use in ALIGN

Platform: OEM719, OEM729, OEM7500, OEM7600, OEM7700, OEM7720, PwrPak7, SPAN CPT7, SMART7

NOVATELXREF is a proprietary extended reference station message for use in ALIGN configurations only. This message enables the output of the **MASTERPOS** log (see page 521), **ROVERPOS** log (see page 661) and **ALIGNBSLNENU** log (see page 348) on the rover.

Message ID: 1620

Log Type: Synch

Recommended Input:

```
log com2 novatelxref ontime 1
```

3.93 OCEANIXINFO

Oceanix subscription information

Platform: OEM719, OEM729, OEM7500, OEM7600, OEM7700, OEM7720, PwrPak7, SPAN CPT7, SMART7

This log contains details on the Oceanix subscription.

Message ID: 2159

Log Type: Asynch

Recommended Input:

```
log oceanixinfoa onchanged
```

ASCII Example:

```
#OCEANIXINFOA,COM1,0,83.0,FINESTEERING,1987,253328.270,02040020,9ce8,14635;
"QU242:3004:3631",TERM,80001803,44,2018,0,NEARSHORE*de2b56e3
```

Field	Field Type	Description	Format	Binary Bytes	Binary Offset
1	OCEANIXINFO header	Log header. See <i>Messages</i> on page 27 for more information.		H	0
2	PAC	Product activation code	Char [16]	16	H
3	Type	Subscription type (see <i>Table 107: Oceanix Subscription Type</i> on the next page)	Enum	4	H+16
4	Subscription permissions	Services permitted by the subscription (see <i>Table 108: Oceanix Subscription Details Mask</i> on the next page) Note: Bits in the Reserved areas of this field may be set, but the Reserved bits should be ignored.	Hex	4	H+20
5	Service End Day	Last day of the year for which service is available. Service expires at the end of this UTC day. For example, if the Service End Year and Day are 2019 and 15, respectively, then the service will expire on January 15, 2019 at 24:00 UTC.	Ulong	4	H+24
6	Service End Year	Year that the subscription ends.	Ulong	4	H+28
7	Reserved		Ulong	4	H+32

Field	Field Type	Description	Format	Binary Bytes	Binary Offset
8	Region restriction	For region restricted subscriptions, the type of region restriction (see <i>Table 109: Oceanix Region Restriction</i> below)	Enum	4	H+36
9	xxxx	32-bit CRC (ASCII and Binary only)	Ulong	4	H+40
10	[CR][LF]	Sentence terminator (ASCII only)	-	-	-

Table 107: Oceanix Subscription Type

ASCII	Binary	Description
UNASSIGNED	0	Decoder has not had an assigned operating mode
TERM	1	Term subscription
MODEL	5	Reserved
BUBBLE	100	Receiver is operating in an Oceanix-permitted subscription-free bubble
INCOMPATIBLE_SUBSCRIPTION	104	Subscription is incompatible with this version of firmware

Table 108: Oceanix Subscription Details Mask

Bit	Mask	Description
0	0x00000001	Reserved
1	0x00000002	Oceanix - H service
2-31	0xFFFFFFFFC	Reserved

Table 109: Oceanix Region Restriction

ASCII	Binary	Description
NONE	0	Oceanix operation has no region restrictions
GEOGATED	1	Oceanix operation is limited to land regions. GEOGATED is also the default value reported if there is no subscription
NEARSHORE	3	Oceanix operation is limited to land and near shore (coastal) regions

3.94 OCEANIXSTATUS

Oceanix decoder and subscription status

Platform: OEM719, OEM729, OEM7500, OEM7600, OEM7700, OEM7720, PwrPak7, SPAN CPT7, SMART7

This log contains status information for the Oceanix decoder and subscription.

Message ID: 2160

Log Type: Asynch

Recommended Input:

```
log oceanixstatusa onchanged
```

ASCII Example:

```
#OCEANIXSTATUSA,COM1,0,89.0,FINESTEERING,1982,315542.430,03000020,049a,32768;
ENABLE,LOCKED,IN_REGION*954083ea
```

Field	Field Type	Description	Format	Binary Bytes	Binary Offset
1	OCEANIXSTATUS header	Log header. See <i>Messages</i> on page 27 for more information.		H	0
2	Access	Access status. ENABLE (1) if the subscription is valid. DISABLE (0) otherwise	Enum	4	H
3	Sync state	Decoder data synchronization state (see <i>Table 110: Decoder Data Synchronization State</i> below)	Enum	4	H+4
4	Region restriction status	Region restriction status (see <i>Table 111: Region Restriction Status</i> on the next page)	Enum	4	H+8
5	xxxx	32-bit CRC (ASCII and Binary only)	Ulong	4	H+12
6	[CR][LF]	Sentence terminator (ASCII only)	-	-	-

Table 110: Decoder Data Synchronization State

ASCII	Binary	Description
NO_SIGNAL	0	None of the decoders have received data in the last 30 seconds
SEARCH	1	At least one decoder is receiving data and is searching for the format
LOCKED	2	At lease one decoder has locked onto the format

Table 111: Region Restriction Status

ASCII	Binary	Description
UNKNOWN	0	Region restriction status cannot be determined
IN_REGION	1	Receiver is within the permitted region
OUT_OF_REGION	2	Receiver is outside the permitted region

3.95 PASSCOM, PASSAUX, PASSUSB, PASSETH1, PASSICOM, PASSNCOM

Redirects data

Platform: OEM719, OEM729, OEM7500, OEM7600, OEM7700, OEM7720, PwrPak7, SPAN CPT7, SMART7, SMART2

The pass-through logging feature enables the receiver to redirect any ASCII or binary data, input at a specified port, to any specified receiver port. It allows the receiver to perform bi-directional communications with other devices such as a modem, terminal or another receiver. See also the **INTERFACEMODE** command on page 148.

There are many pass through logs: PASSCOM1, PASSCOM2, PASSCOM3, PASSCOM4, PASSCOM5, PASSCOM6, PASSAUX, PASSETH1, PASSICOM1, PASSICOM2, PASSICOM3, PASSICOM4, PASSICOM5, PASSICOM6, PASSICOM7, PASSNCOM1, PASSNCOM2, PASSNCOM3 allow for redirection of data that is arriving at COM1, COM2, COM3, virtual COM1, virtual COM2 or AUX. PASSCOM4 and PASSCOM5 are only available on OEM7600, OEM7700 and OEM7720 receivers. The AUX port is available on some products. PASSUSB1, PASSUSB2, PASSUSB3 are used to redirect data from USB1, USB2 or USB3. PASSETH1 is only available on receivers supporting Ethernet and can be used to redirect data from ETH1.

A pass through log is initiated the same as any other log, that is, log [to-port] [data-type] [trigger]. However, pass-through can be more clearly specified as: log [to-port] [from-port-AB] [onchanged]. Now, the [from-port-AB] field designates the port which accepts data (that is, COM1, COM2, COM3, COM4, COM5, COM6, AUX, USB1, USB2 or USB3) as well as the format in which the data is logged by the [to-port] (A for ASCII or B for Binary).



To pass through data arriving on all ports, use the **PASSTHROUGH** log (see page 557).

When the [from-port-AB] field is suffixed with an [A], all data received by that port is redirected to the [to-port] in ASCII format and logs according to standard NovAtel ASCII format. Therefore, all incoming ASCII data is redirected and output as ASCII data. However, any binary data received is converted to a form of ASCII hexadecimal before it is logged.

When the [from-port-AB] field is suffixed with a [B], all data received by that port is redirected to the [to-port] exactly as it is received. The log header and time tag adhere to standard NovAtel Binary format followed by the pass through data as it was received (ASCII or binary).

Pass through logs are best utilized by setting the [trigger] field as onchanged or onnew.

If the data being injected is ASCII, then the data is grouped together with the following rules:

- blocks of 80 characters
- any block of characters ending in a <CR>
- any block of characters ending in a <LF>
- any block remaining in the receiver code when a timeout occurs (100 ms)

If the data being injected is binary or the port INTERFACEMODE mode is set to GENERIC, then the data is grouped as follows:

- blocks of 80 bytes
- any block remaining in the receiver code when a timeout occurs (100 ms)

If a binary value is encountered in an ASCII output, then the byte is output as a hexadecimal byte preceded by a backslash and an x. For example 0A is output as \x0A. An actual '\ ' in the data is output as \\. The output counts as one pass through byte although it is four characters.

The first character of each pass-through record is time tagged in GPS reference weeks and seconds.

PASSAUX	Message ID: 690
PASSCCOM1	Message ID: 1893
PASSCCOM2	Message ID: 1894
PASSCCOM3	Message ID: 1895
PASSCCOM4	Message ID: 1930
PASSCCOM5	Message ID: 1937
PASSCCOM6	Message ID: 1938
PASSCOM1	Message ID: 233
PASSCOM2	Message ID: 234
PASSCOM3	Message ID: 235
PASSCOM4	Message ID: 1384
PASSCOM5	Message ID: 1576
PASSCOM6	Message ID: 1577
PASSCOM7	Message ID: 1701
PASSCOM8	Message ID: 1702
PASSCOM9	Message ID: 1703
PASSCOM10	Message ID: 1704
PASSETH1	Message ID: 1209
PASSICOM1	Message ID: 1250
PASSICOM2	Message ID: 1251
PASSICOM3	Message ID: 1252
PASSICOM4	Message ID: 1385
PASSICOM5	Message ID: 2119
PASSICOM6	Message ID: 2120
PASSICOM7	Message ID: 2121
PASSNCOM1	Message ID: 1253
PASSNCOM2	Message ID: 1254
PASSNCOM3	Message ID: 1255
PASSUSB1	Message ID: 607
PASSUSB2	Message ID: 608
PASSUSB3	Message ID: 609

Log Type: Asynch

Recommended Input:

log passcom1a onchanged



Asynchronous logs should only be logged ONCHANGED otherwise the most current data is not output when it is available. This is especially true of the ONTIME trigger, which may cause inaccurate time tags to result.

ASCII Example 1:

```
#PASSCOM2A,COM1,0,59.5,FINESTEERING,1337,400920.135,02000000,2b46,1984;80,
#BESTPOSA,COM3,0,80.0,FINESTEERING,1337,400920.000,02000000,4ca6,1899;
SOL_COMPUT*f9dfab46
#PASSCOM2A,COM1,0,64.0,FINESTEERING,1337,400920.201,02000000,2b46,1984;80,ED,
SINGLE,51.11636326036,-114.03824210485,1062.6015,-16.2713,WGS84,1.8963,
1.0674*807fd3ca
#PASSCOM2A,COM1,0,53.5,FINESTEERING,1337,400920.856,02000000,2b46,1984;49,,
2.2862,"",0.000,0.000,9,9,0,0,0,0,0,0*20b24878\x0d\x0a*3eef4220
#PASSCOM1A,COM1,0,53.5,FINESTEERING,1337,400922.463,02000000,13ff,1984;17,
unlog passcom2a\x0d\x0a*ef8d2508
```

ASCII Example 2:

```
#PASSCOM2A,COM1,0,53.0,FINESTEERING,1337,400040.151,02000000,2b46,1984;80,\x99A
\x10\x04\x07yN&\xc6\xea\x10\x00\x01\xde\x00\x00\x10\xfe\xbf\xfe1\xfe\x9c\x1f4
\x03\xe2\xef\x9f\x1f\x1f\x3\xff\xd6\xff\xc3_A~z\xaa\xfe\xbf\x1f9\xd3\xf8\xd4\xf4-
\xe8kHo\xe2\x00>\xe0QOC>\xc3\x9c\x11\xff\x7f\xf4\xa1\xf3t\xf4'\xf4xvo\xe6\x00
\x9d*dcd2e989
```

In the example, note that '~' is a printable character.

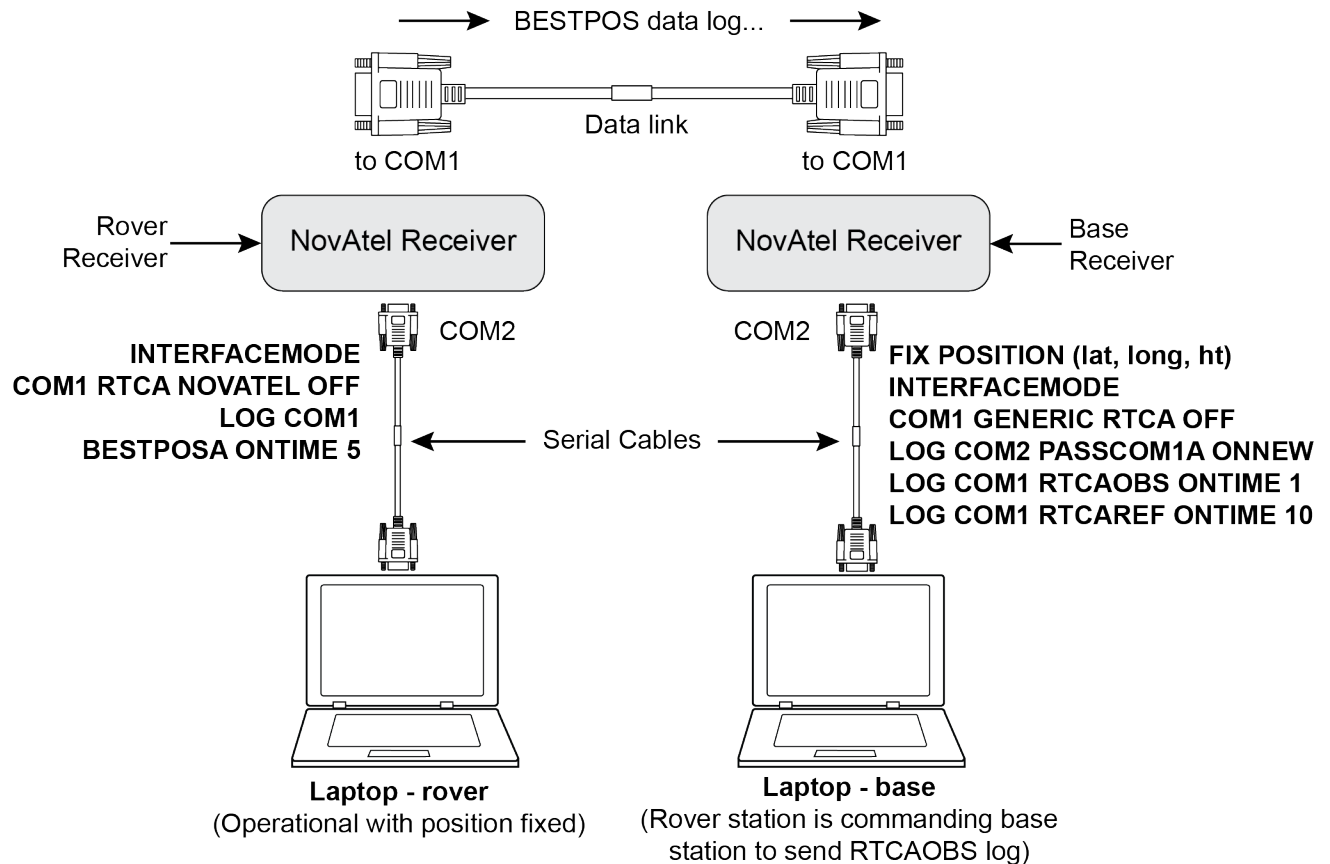

For example, you could connect two OEM7 family receivers together via their COM1 ports such as in the *Figure 7: Pass Through Log Data* on the next page (a rover station to base station scenario). If the rover station is logging BESTPOSA data to the base station, it is possible to use the pass through logs to pass through the received BESTPOSA data to a disk file (let's call it diskfile.log) at the base station host PC hard disk.

Figure 7: Pass Through Log Data

Under default conditions, the two receivers "chatter" back and forth with the Invalid Command Option message (due to the command interpreter in each receiver not recognizing the command prompts of the other receiver). The chattering in turn causes the accepting receiver to transmit new pass through logs with the response data from the other receiver. To avoid the chattering problem, use the **INTERFACEMODE** command (see page 148) on the accepting port to disable error reporting from the receiving port command interpreter.

If the accepting port's error reporting is disabled by INTERFACEMODE, the BESTPOSA data record passes through and creates two records.

The reason that two records are logged from the accepting receiver is the first record was initiated by receipt of the BESTPOSA first terminator <CR>. The second record followed in response to the BESTPOSA second terminator <LF>.

Note the time interval between the first character received and the terminating <LF> can be calculated by differencing the two GPS reference time tags. This pass through feature is useful for time tagging the arrival of external messages. These messages can be any user related data. When using this feature for tagging external events, it is recommended that the rover receiver be disabled from interpreting commands so the receiver does not respond to the messages, using the **INTERFACEMODE** command (see page 148).

If the BESTPOSB binary log data is input to the accepting port (log com2 passcom1a onchanged), the BESTPOSB binary data at the accepting port is converted to a variation of ASCII hexadecimal before it is passed through to com2 port for logging.

Field	Field Type	Description	Format	Binary Bytes	Binary Offset
1	PASSCOM header	Log header. See <i>Messages</i> on page 27 for more information.		H	0
2	#bytes	Number of bytes to follow	Ulong	4	H
3	data	Message data	Char [80]	80	H+4
4	xxxx	32-bit CRC (ASCII and Binary only)	Ulong	4	H+4+ (#bytes)
5	[CR][LF]	Sentence terminator (ASCII only)	-	-	-

3.96 PASSTHROUGH

Redirected data from all ports

Platform: OEM719, OEM729, OEM7500, OEM7600, OEM7700, OEM7720, PwrPak7, SPAN CPT7, SMART7, SMART2

This log outputs pass through data from all receiver ports. The behavior is the same as the port specific pass though logs described in *PASSCOM*, *PASSAUX*, *PASSUSB*, *PASSETH1*, *PASSICOM*, *PASSNCOM* on page 552.

Message ID: 1342

Log Type: Asynch

Recommended Input:

```
log passthrougha onchanged
```

ASCII Example:

```
#PASSTHROUGH, COM1, 0, 73.0, FINESTEERING, 1625, 165965.067, 02040008, 5fa3, 39275;
USB1, 80, i\xd3\x00\x87>\xb0\x00'\x91\xb3"\xa0D?\xaa\xb2\x00\x07op\x18@\x05\xe9
\xd4\x08\xe7\x03\x7f\xfd\x18{\x80w\xff\xf2N_cy\x11\x80\x0bC\xdc\x01@\x00\xdf
\xb1'\x873\xff\x81j]\x7f\xe3\xff\xea\x83v\x08M\xd8?\xfcr\xf7\x01\x18\x00\x17
\x1d2\xd1\xd1b\x00*5cb8bd9a
```

Field	Field type	Description	Format	Binary Bytes	Binary Offset
1	PASSTHROUGH header	Log header. See <i>Messages</i> on page 27 for more information.		H	0
2	Port	See <i>Table 51: COM Port Identifiers</i> on page 278	Enum	4	H
3	#bytes	Number of bytes to follow	Ulong	4	H+4
4	data	Message data	Char [80]	80	H+8
5	xxxx	32-bit CRC (ASCII and Binary only)	Ulong	4	H+8+ #bytes
6	[CR][LF]	Sentence terminator (ASCII only)	-	-	-

3.97 PDPDOP

DOP values for the satellites in the PDP solution

Platform: OEM719, OEM729, OEM7500, OEM7600, OEM7700, OEM7720, PwrPak7, SPAN CPT7, SMART7, SMART2

The PDPDOP log contains the Dilution Of Precision (DOP) values for the satellites being used in the PDP solution. The PDP DOPs are updated every 60 seconds or whenever the satellites used in the PDP solution changes.

DOP values are a measure of the solution strength. Essentially, the DOPs reflect the geometry of the satellites used in the solution. Solutions with good counts of well-distributed satellites will have low DOPs and should be accurate and reliable. Solutions with fewer or poorly-distributed satellites will have high DOPs and be less accurate and reliable. As a rough guideline, PDOP values less than 4 imply a solution with reasonable geometry.

There can be many reasons for high DOP values. The most common reason is that there are obstructions limiting satellite visibility. Even if satellites are visible and being tracked they might still not be used in the solution if, for example, they are unhealthy or there are not corrections available for them. The **PDPSATS** log (see page 564) will inform which satellites are being tracked and explain why a tracked satellite is not used in the solution.

The DOPs do not consider that different satellites or signals will be weighted differently in the solution. Therefore, they do not completely reflect the solution quality. Ultimately, the standard deviations reported in the **PDPOPS** log (see page 562) are the best reflection of the solution accuracy.

Message ID: 1998

Log Type: Asynch

Recommended Input:

```
log pdpdopa onchanged
```

ASCII Example:

```
#PDPDOPA,USB1,0,82.0,FINESTEERING,2010,149390.500,02000008,3bf3,32768;1.6490,0.9960,0.5950,0.7950,0.5280,5.0,22,3,28,19,6,2,24,12,22,17,1,50,59,61,52,60,51,1,30,12,11,6,9*13e052ef
```

Field	Field Type	Description	Format	Binary Bytes	Binary Offset
1	PDPDOP header	Log header. See <i>Messages</i> on page 27 for more information.	-	H	0
2	gdop	Geometric dilution of precision - assumes 3D position and receiver clock offset (all 4 parameters) are unknown	Float	4	H
3	pdop	Position dilution of precision - assumes 3D position is unknown and receiver clock offset is known	Float	4	H+4
4	hdop	Horizontal dilution of precision	Float	4	H+8

Field	Field Type	Description	Format	Binary Bytes	Binary Offset
5	htdop	Horizontal position and time dilution of precision	Float	4	H+12
6	tdop	Time dilution of precision - assumes 3D position is known and only the receiver clock offset is unknown	Float	4	H+16
7	cutoff	GPS elevation cut-off angle	Float	4	H+20
8	#PRN	Number of satellites PRNs to follow	Long	4	H+24
9	PRN	PRN of a satellite used in the position solution	Ulong	4	H+28
10	Next PRN offset = $H+28+(\#prn \times 4)$				
11	xxxx	32-bit CRC (ASCII and Binary only)	Ulong	4	H+28+ (#prn x 4)
12	[CR] [LF]	Sentence terminator (ASCII only)	-	-	-

3.98 PDPDOP2

DOP values for the satellites used in the PDP solution

Platform: OEM719, OEM729, OEM7500, OEM7600, OEM7700, OEM7720, PwrPak7, SPAN CPT7, SMART7, SMART2

The PDPDOP2 log contains the Dilution Of Precision (DOP) values for the satellites being used in the PDP solution. This log is similar to the **PDPDOP** log (see page 558) but contains the per-system TDOPs; see the **PDPDOP** log on page 558 for more information on the DOPs.

Message ID: 1995

Log Type: Asynch

Recommended Input:

```
log pdpdop2a onchanged
```

ASCII Example:

```
#PDPDOP2A,USB1,0,82.0,FINESTEERING,2010,149390.500,02000008,2488,32768;1.6490,0.9960,0.5950,0.7990,4,GPS,0.5280,GLONASS,0.6880,GALILEO,0.7200,BEIDOU,0.6750*25f8324a
```

Field	Field type	Description	Format	Binary Bytes	Binary Offset
1	PDPDOP2 header	Log header. See <i>Messages</i> on page 27 for more information.		H	0
2	GDOP	Geometric dilution of precision - assumes 3D position and receiver clock offset (all 4 parameters) are unknown	Float	4	H
3	PDOP	Position dilution of precision - assumes 3D position is unknown and receiver clock offset is known	Float	4	H+4
4	HDOP	Horizontal dilution of precision	Float	4	H+8
5	VDOP	Vertical dilution of precision	Float	4	H+12
6	#systems	Number of systems	Ulong	4	H+16
7	system	See <i>Table 112: System Used for Timing</i> on the next page	Enum	4	H+20
8	TDOP	Time dilution of precision	Float	4	H+24
9	Next system offset = H+20+(#systems x 8)				
10	xxxx	32-bit CRC (ASCII and Binary only)	Hex	4	H+20+ (#systems x 8)
11	[CR][LF]	Sentence terminator (ASCII only)	-	-	-

Table 112: System Used for Timing

Binary	ASCII
0	GPS
1	GLONASS
2	GALILEO
3	BEIDOU
4	NAVIC
99	AUTO ¹

¹AUTO is used only as a backup system (not available for primary system field).

3.99 PDPPOS

PDP filter position

Platform: OEM719, OEM729, OEM7500, OEM7600, OEM7700, OEM7720, PwrPak7, SPAN CPT7, SMART7, SMART2

The PDPPOS log contains the receiver position computed by the receiver with the PDP filter enabled. See also the **PDPFILTER** command on page 206.

Message ID: 469

Log Type: Synch

Recommended Input:

```
log pdpposa ontime 1
```

ASCII Example:

```
#PDPPOSA,COM1,0,75.5,FINESTEERING,1431,494991.000,02040000,a210,35548;
SOL_COMPUTED,SINGLE,51.11635010310,-114.03832575772,1065.5019,-16.9000,WGS84,
4.7976,2.0897,5.3062,"",0.000,0.000,8,8,0,0,0,0,0,0*3cbfa646
```

Field	Field type	Description	Format	Binary Bytes	Binary Offset
1	PDPPOS header	Log header. See <i>Messages</i> on page 27 for more information.		H	0
2	sol status	Solution status (refer to <i>Table 65: Solution Status</i> on page 374)	Enum	4	H
3	pos type	Position type (refer to <i>Table 66: Position or Velocity Type</i> on page 375)	Enum	4	H+4
4	lat	Latitude (degrees)	Double	8	H+8
5	lon	Longitude (degrees)	Double	8	H+16
6	hgt	Height above mean sea level (m)	Double	8	H+24
7	undulation	Undulation - the relationship between the geoid and the WGS84 ellipsoid (m) <div style="border: 1px solid black; padding: 5px; margin-top: 10px;">  <p>When using a datum other than WGS84, the undulation value also includes the vertical shift due to differences between the datum in use and WGS84.</p> </div>	Float	4	H+32

Field	Field type	Description	Format	Binary Bytes	Binary Offset
8	datum id#	Datum ID number 61 = WGS84 63 = USER	Enum	4	H+36
9	lat σ	Latitude standard deviation (m)	Float	4	H+40
10	lon σ	Longitude standard deviation (m)	Float	4	H+44
11	hgt σ	Height standard deviation (m)	Float	4	H+48
12	stn id	Base station ID	Char[4]	4	H+52
13	diff_age	Differential age in seconds	Float	4	H+56
14	sol_age	Solution age in seconds	Float	4	H+60
15	#sats	Number of satellites tracked	Uchar	1	H+64
16	#sats soln	Number of satellites in the solution	Uchar	1	H+65
17	Reserved		Uchar	1	H+66
18			Uchar	1	H+67
19			Hex	1	H+68
20	ext sol stat	Extended solution status (see <i>Table 69: Extended Solution Status</i> on page 378)	Hex	1	H+69
21	Galileo and BeiDou sig mask	Galileo and BeiDou signals used mask (see <i>Table 68: Galileo and BeiDou Signal-Used Mask</i> on page 378)	Hex	1	H+70
22	GPS and GLONASS sig mask	GPS and GLONASS signals used mask (see <i>Table 67: GPS and GLONASS Signal-Used Mask</i> on page 377)	Hex	1	H+71
23	xxxx	32-bit CRC (ASCII and Binary only)	Hex	4	H+72
24	[CR][LF]	Sentence terminator (ASCII only)	-	-	-

3.100 PDPSATS

Satellites used in PDPPPOS solution

Platform: OEM719, OEM729, OEM7500, OEM7600, OEM7700, OEM7720, PwrPak7, SPAN CPT7, SMART7, SMART2

This log lists the used and unused satellites for the corresponding PDPPPOS solution. It also describes the signals of the used satellites and reasons for exclusions.

Message ID: 1234

Log Type: Synch

Recommended Input:

```
log pdpsatsa ontime 1
```

Abbreviated ASCII Example:

```
<PDPSATS COM1 0 80.0 FINESTEERING 1690 603073.000 02000008 be33 43488
< 21
< GPS 11 GOOD 00000001
< GPS 27 GOOD 00000001
...
< GPS 1 GOOD 00000001
< GPS 7 GOOD 00000001
< SBAS 133 NOTUSED 00000000
< SBAS 138 NOTUSED 00000000
< SBAS 135 NOTUSED 00000000
< GLONASS 10-7 GOOD 00000001
< GLONASS 21+4 GOOD 00000001
...
< GLONASS 12-1 GOOD 00000001
< GLONASS 11 GOOD 00000001
```

Field	Field type	Description	Format	Binary Bytes	Binary Offset
1	PDPSATS header	Log header. See <i>Messages</i> on page 27 for more information.		H	0
2	#entries	Number of records to follow	Ulong	4	H
3	system	See <i>Table 93: Satellite System</i> on page 477	Enum	4	H+4
4	Satellite ID	Satellite identifier	Ulong	4	H+8
5	Status	Satellite status (see <i>Table 71: Observation Statuses</i> on page 381)	Enum	4	H+12

Field	Field type	Description	Format	Binary Bytes	Binary Offset
6	Status mask	See Table 72: BESTSATS GPS Signal Mask on page 382, Table 73: BESTSATS GLONASS Signal Mask on page 383, Table 74: BESTSATS Galileo Signal Mask on page 383, and Table 75: BESTSATS BeiDou Signal Mask on page 383	Hex	4	H+16
7	Next satellite offset = H+4+(#sat x 16)				
8	xxxx	32-bit CRC (ASCII and Binary only)	Ulong	4	H+4+ (#sat x 16)
9	[CR][LF]	Sentence terminator (ASCII only)	-	-	-

3.101 PDPVEL

PDP filter velocity

Platform: OEM719, OEM729, OEM7500, OEM7600, OEM7700, OEM7720, PwrPak7, SPAN CPT7, SMART7, SMART2

The PDPVEL log contains the pseudorange velocity computed by the receiver with the PDP filter enabled. See also the **PDPFILTER** command on page 206.

Message ID: 470

Log Type: Synch

Recommended Input:

```
log pdpvela ontime 1
```

ASCII Example:

```
#PDPVELA,COM1,0,75.0,FINESTEERING,1430,505990.000,02000000,b886,2859;  
SOL_COMPUTED,SINGLE,0.150,0.000,27.4126,179.424617,-0.5521,0.0*7746b0fe
```

Field	Field type	Description	Format	Binary Bytes	Binary Offset
1	PDPVEL header	Log header. See <i>Messages</i> on page 27 for more information.		H	0
2	sol status	Solution status (refer to <i>Table 65: Solution Status</i> on page 374)	Enum	4	H
3	vel type	Velocity type (refer to <i>Table 66: Position or Velocity Type</i> on page 375)	Enum	4	H+4
4	latency	A measure of the latency in the velocity time tag in seconds. It should be subtracted from the time to give improved results	Float	4	H+8
5	age	Differential age in seconds	Float	4	H+12
6	hor spd	Horizontal speed over ground, in meters per second	Double	8	H+16
7	trk gnd	Actual direction of motion over ground (track over ground) with respect to True North, in degrees	Double	8	H+24
8	height	Height in meters where positive values indicate increasing altitude (up) and negative values indicate decreasing altitude (down)	Double	8	H+32
9	Reserved		Float	4	H+40
10	xxxx	32-bit CRC (ASCII and Binary only)	Ulong	4	H+44
11	[CR] [LF]	Sentence terminator (ASCII only)	-	-	-

3.102 PDPXYZ

PDP filter Cartesian position and velocity

Platform: OEM719, OEM729, OEM7500, OEM7600, OEM7700, OEM7720, PwrPak7, SPAN CPT7, SMART7, SMART2

The PDPXYZ log contains the Cartesian position in X, Y and Z coordinates as computed by the receiver with the PDP filter enabled. See also the **PDPFILTER** command on page 206.

Message ID: 471

Log Type: Synch

Recommended Input:

```
log pdpxyza ontime 1
```

ASCII Example:

```
#PDPXYZA,COM1,0,75.5,FINESTEERING,1431,494991.000,02040000,33ce,35548;
SOL_COMPUTED,SINGLE,-1634531.8128,-3664619.4862,4942496.5025,2.9036,6.1657,
3.0153,SOL_COMPUTED,SINGLE,-2.5588e-308,-3.1719e-308,3.9151e-308,0.0100,0.0100,
0.0100,"",0.150,0.000,0.000,8,8,0,0,0,0,0,0*a20dbd4f
```

Field	Field type	Description	Format	Binary Bytes	Binary Offset
1	PDPXYZ header	Log header. See <i>Messages</i> on page 27 for more information.		H	0
2	P-sol status	Solution status (refer to <i>Table 65: Solution Status</i> on page 374)	Enum	4	H
3	pos type	Position type (refer to <i>Table 66: Position or Velocity Type</i> on page 375)	Enum	4	H+4
4	P-X	Position X-coordinate (m)	Double	8	H+8
5	P-Y	Position Y-coordinate (m)	Double	8	H+16
6	P-Z	Position Z-coordinate (m)	Double	8	H+24
7	P-X σ	Standard deviation of P-X (m)	Float	4	H+32
8	P- Y σ	Standard deviation of P-Y (m)	Float	4	H+36
9	P-Z σ	Standard deviation of P-Z (m)	Float	4	H+40
10	V-sol status	Solution status (refer to <i>Table 65: Solution Status</i> on page 374)	Enum	4	H+44
11	vel type	Velocity type (refer to <i>Table 66: Position or Velocity Type</i> on page 375)	Enum	4	H+48
12	V-X	Velocity vector along X-axis (m)	Double	8	H+52

Field	Field type	Description	Format	Binary Bytes	Binary Offset
13	V-Y	Velocity vector along Y-axis (m)	Double	8	H+60
14	V-Z	Velocity vector along Z-axis (m)	Double	8	H+68
15	V-X σ	Standard deviation of V-X (m)	Float	4	H+76
16	V-Y σ	Standard deviation of V-Y (m)	Float	4	H+80
17	V-Z σ	Standard deviation of V-Z (m)	Float	4	H+84
18	stn ID	Base station ID	Char[4]	4	H+88
19	V-latency	A measure of the latency in the velocity time tag in seconds. It should be subtracted from the time to give improved results	Float	4	H+92
20	diff_age	Differential age in seconds	Float	4	H+96
21	sol_age	Solution age in seconds	Float	4	H+100
22	#sats	Number of satellite vehicles tracked	Uchar	1	H+104
23	#sats soln	Number of satellite vehicles used in solution	Uchar	1	H+105
24	Reserved		Uchar	1	H+106
25			Uchar	1	H+107
26			Uchar	1	H+108
27	ext sol stat	Extended solution status (see <i>Table 69: Extended Solution Status</i> on page 378)	Hex	1	H+109
28	Galileo and BeiDou sig mask	Galileo and BeiDou signals used mask (see <i>Table 68: Galileo and BeiDou Signal-Used Mask</i> on page 378)	Hex	1	H+110
29	GPS and GLONASS sig mask	GPS and GLONASS signals used mask (see <i>Table 67: GPS and GLONASS Signal-Used Mask</i> on page 377)	Hex	1	H+111
30	xxxx	32-bit CRC (ASCII and Binary only)	Hex	4	H+112
31	[CR][LF]	Sentence terminator (ASCII only)	-	-	-

3.103 PORTSTATS

Port statistics

Platform: OEM719, OEM729, OEM7500, OEM7600, OEM7700, OEM7720, PwrPak7, SPAN CPT7, SMART7, SMART2

This log conveys various status parameters of the receiver's communication ports. The receiver maintains a running count of a variety of status indicators of the data link. This log outputs a report of those indicators.

Message ID: 72

Log Type: Polled

Recommended Input:

```
log portstatsa once
```

ASCII example:

```
#PORTSTATSA,USB1,0,69.5,FINESTEERING,1971,489026.000,02004020,a872,14434;29,COM
1,0,3109742555,0,0,435636653,0,0,0,0,COM2,0,207,0,0,32,0,0,0,0,COM3,0,207,0,0,3
2,0,0,0,0,FILE,0,0,0,0,0,0,0,0,USB1,175513,21321491,175513,0,0,0,0,0,USB2,0
,0,0,0,0,0,0,0,0,USB3,0,0,0,0,0,0,0,0,COM4,139542424,189379232,139542424,0,69
771230,0,0,0,0,ICOM1,0,0,0,0,0,0,0,0,0,ICOM2,0,0,0,0,0,0,0,0,0,ICOM3,0,0,0,0,0,
0,0,0,0,NCOM1,0,0,0,0,0,0,0,0,0,NCOM2,0,0,0,0,0,0,0,0,0,NCOM3,0,0,0,0,0,0,0,
,ICOM4,0,0,0,0,0,0,0,0,0,WCOM1,0,394864554,0,0,0,0,0,0,COM5,0,6,0,0,4,0,0,0,0
,CCOM1,0,0,0,0,0,0,0,0,0,CCOM2,0,0,0,0,0,0,0,0,0,CCOM3,0,0,0,0,0,0,0,0,0,CCOM4,
0,0,0,0,0,0,0,0,0,CCOM5,0,0,0,0,0,0,0,0,0,CCOM6,0,0,0,0,0,0,0,0,0,ICOM5,0,0,0,0
,0,0,0,0,0,0,ICOM6,0,0,0,0,0,0,0,0,0,ICOM7,0,0,0,0,0,0,0,0,0,*b9c28761
```



Parity and framing errors occur for COM ports if poor transmission lines are encountered or if there is an incompatibility in the data protocol. If errors occur, you may need to confirm the bit rate, number of data bits, number of stop bits and parity of both the transmit and receiving ends. Characters may be dropped when the CPU is overloaded.

Field	Field type	Description	Format	Binary Bytes	Binary Offset
1	PORTSTATS header	Log header. See <i>Messages</i> on page 27 for more information.		H	0
2	#port	Number of ports with information to follow	Long	4	H
3	port	Refer to <i>Table 25: Communications Port Identifiers</i> on page 110	Enum	4	H+4
4	rx chars	Total number of characters received through this port	Ulong	4	H+8
5	tx chars	Total number of characters transmitted through this port	Ulong	4	H+12

Field	Field type	Description	Format	Binary Bytes	Binary Offset
6	acc rx chars	Total number of accepted characters received through this port	Ulong	4	H+16
7	dropped rx chars	Number of software overruns in receive	Ulong	4	H+20
8	interrupts	Number of interrupts on this port	Ulong	4	H+24
9	breaks	Number of breaks (only for serial ports)	Ulong	4	H+28
10	par err	Number of parity errors (only for serial ports)	Ulong	4	H+32
11	frame err	Number of framing errors (only for serial ports)	Ulong	4	H+36
12	rx overruns	Number of hardware overruns in receive	Ulong	4	H+40
13	Next port offset = H+4+(#port x 40)				
14	xxxx	32-bit CRC (ASCII and Binary only)	Ulong	4	H+4+ (#port x 40)
15	[CR][LF]	Sentence terminator (ASCII only)	-	-	-

3.104 PPPDATUMINFO

Datum information for the PPP position

Platform: OEM719, OEM729, OEM7500, OEM7600, OEM7700, OEM7720, PwrPak7, SPAN CPT7, SMART7, SMART2

This log reports the datum and co-ordinate epoch of the solution in the **PPPPOS** log (see page 572).

Message ID: 2293

Log Type: Asynch

Recommended Input:

```
log pppdatuminfoa onchanged
```

ASCII Example:

```
#PPPDATUMINFOA, COM1, 0, 75.5, FINESTEERING, 2044, 510000.000, 02000020, ea8d, 15427;  
"ITRF2014", 1165, 2019.202, GOOD*2f28701e
```

Field	Field Type	Description	Format	Binary Bytes	Binary Offset
1	PPPDATUMINFO header	Log header. See <i>Messages</i> on page 27 for more information.	-	H	0
2	datum	Datum of the position being output by the PPPPOS log.	Char [32]	variable	H
3	epsg_code	EPSG code of datum.	Ulong	4	variable
4	epoch	Co-ordinate epoch (decimal year) Example: 2011.00 = Jan 1, 2011 2011.19 = Mar 11, 2011	Double	8	variable
5	status	Transformation Status. See <i>Table 64: Transformation Status</i> on page 369.	Enum	4	variable
6	xxxx	32-bit CRC (ASCII and Binary only)	Hex	4	variable
7	[CR][LF]	Sentence terminator (ASCII only)	-	-	-

3.105 PPPPOS

PPP filter position

Platform: OEM719, OEM729, OEM7500, OEM7600, OEM7700, OEM7720, PwrPak7, SPAN CPT7, SMART7, SMART2

This log contains the position solution computed by the PPP filter.

Message ID: 1538

Log Type: Synch

Recommended Input:

```
log pppposa ontime 1
```

ASCII Example:

```
#PPPPOSA,COM1,0,80.0,FINESTEERING,1735,345300.000,02000000,6f47,44027;
SOL_COMPUTED,PPP,51.11635350286,-114.03819287079,1064.5365,-16.9000,
WGS84,0.0375,0.0460,0.0603,"0",4.000,0.000,12,12,12,12,0,00,00,03*ef17d668
```

Field	Field type	Description	Format	Binary Bytes	Binary Offset
1	PPPPOS header	Log header. See <i>Messages</i> on page 27 for more information.		H	0
2	Status	Solution status (see <i>Table 65: Solution Status</i> on page 374)	Enum	4	H
3	Type	Position type (see <i>Table 113: Position Type</i> on the next page)	Enum	4	H+4
4	lat	Latitude (degrees)	Double	8	H+8
5	lon	Longitude (degrees)	Double	8	H+16
6	hgt	Height above mean sea level (m)	Double	8	H+24
7	undulation	Undulation - the relationship between the geoid and the WGS84 ellipsoid (m) ¹	Float	4	H+32
8	datum id#	Datum ID number 61 = WGS84 63 = USER	Enum	4	H+36
9	lat σ	Latitude standard deviation (m)	Float	4	H+40
10	lon σ	Longitude standard deviation (m)	Float	4	H+44

¹When using a datum other than WGS84, the undulation value also includes the vertical shift due to differences between the datum in use and WGS84.

Field	Field type	Description	Format	Binary Bytes	Binary Offset
11	hgt σ	Height standard deviation (m)	Float	4	H+48
12	stn id	Base station ID	Char[4]	4	H+52
13	diff_age	Differential age in seconds	Float	4	H+56
14	sol_age	Solution age in seconds	Float	4	H+60
15	#SVs	Number of satellites tracked	Uchar	1	H+64
16	#solnSVs	Number of satellites vehicles used in solution	Uchar	1	H+65
17	#ggL1	Number of GPS plus GLONASS plus BDS L1/B1 used in solution	Uchar	1	H+66
18	#solnMultiSVs	Number of satellites with multi-frequency signals used in solution	Uchar	1	H+67
19	Reserved		Hex	1	H+68
20	ext sol stat	Extended solution status (see <i>Table 69: Extended Solution Status</i> on page 378)	Hex	1	H+69
21	Reserved		Hex	1	H+70
22	GPS and GLONASS sig mask	GPS and GLONASS signals used mask (see <i>Table 67: GPS and GLONASS Signal-Used Mask</i> on page 377 or <i>Table 68: Galileo and BeiDou Signal-Used Mask</i> on page 378)	Hex	1	H+71
23	xxxx	32-bit CRC (ASCII and Binary only)	Ulong	4	H+72
24	[CR][LF]	Sentence terminator (ASCII only)	-	-	-

Table 113: Position Type

ASCII	Binary	Description
NONE	0	No solution
PPP_CONVERGING	68	Converging TerraStar-C, TerraStar-C PRO, TerraStar-X solution
PPP	69	Converged TerraStar-C, TerraStar-C PRO, TerraStar-X solution
PPP_BASIC_CONVERGING	77	Converging TerraStar-L solution
PPP_BASIC	78	Converged TerraStar-L solution

3.106 PPPSATS

Satellites used in the PPPPOS solution

Platform: OEM719, OEM729, OEM7500, OEM7600, OEM7700, OEM7720, PwrPak7, SPAN CPT7, SMART7, SMART2

This log lists the used and unused satellites for the corresponding PPPPOS solution. It also describes the signals of the used satellites and reasons for exclusions.

Message ID: 1541

Log Type: Synch

Recommended Input:

```
log pppsatsa ontime 1
```

Abbreviated ASCII Example:

```
<PPPSATS COM1 0 80.0 FINESTEERING 1735 345300.000 02000000 ce3f 44027
< 12
< GPS 3 GOOD 00000003
< GPS 5 GOOD 00000003
< GPS 6 GOOD 00000003
< GPS 7 GOOD 00000003
< GPS 8 GOOD 00000003
< GPS 10 GOOD 00000003
< GPS 13 GOOD 00000003
< GPS 16 GOOD 00000003
< GPS 19 GOOD 00000003
< GPS 23 GOOD 00000003
< GPS 26 GOOD 00000003
< GPS 28 GOOD 00000003
```

Field	Field type	Description	Format	Binary Bytes	Binary Offset
1	PPPSATS header	Log header. See <i>Messages</i> on page 27 for more information.		H	0
2	#entries	Number of records to follow	Ulong	4	H
3	System	Satellite system (see <i>Table 93: Satellite System</i> on page 477)	Enum	4	H+4

Field	Field type	Description	Format	Binary Bytes	Binary Offset
4	Satellite ID	In binary logs, the satellite ID field is 4 bytes. The 2 lowest-order bytes, interpreted as a USHORT, are the system identifier: for instance, the PRN for GPS, or the slot for GLONASS. The 2 highest-order bytes are the frequency channel for GLONASS, interpreted as a SHORT and zero for all other systems. In ASCII and abbreviated ASCII logs, the satellite ID field is the system identifier. If the system is GLONASS and the frequency channel is not zero, then the signed channel is appended to the system identifier. For example, slot 13, frequency channel -2 is output as 13-2.	Ulong	4	H+8
5	Status	Satellite status (see <i>Table 71: Observation Statuses</i> on page 381)	Enum	4	H+12
6	Signal Mask	Signals used in the solution (see <i>Table 72: BESTSATS GPS Signal Mask</i> on page 382, <i>Table 73: BESTSATS GLONASS Signal Mask</i> on page 383, <i>Table 74: BESTSATS Galileo Signal Mask</i> on page 383 and <i>Table 75: BESTSATS BeiDou Signal Mask</i> on page 383)	Hex	4	H+16
7	Next satellite offset = H + 4 + (#entries x 16)				
8	xxxx	32-bit CRC (ASCII and Binary only)	Ulong	4	H+4+ (#entries x 16)
9	[CR][LF]	Sentence terminator (ASCII only)	-	-	-

3.107 PPPSEEDAPPLICATIONSTATUS

Status of the last-applied PPP seed

Platform: OEM719, OEM729, OEM7500, OEM7600, OEM7700, OEM7720, PwrPak7, SPAN CPT7, SMART7, SMART2

This log is used to monitor the status of the last-applied static PPP seed. For a static seed to shorten the PPP convergence time, the receiver must remain stationary until the seed is applied and confirmed. A status of **APPLIED** means that a seed was successfully applied and movement can start. Movement before seed confirmation will result in the seed being discarded and a full convergence taking place.

The **PPPSEED** command (see page 218) is used to control the application of seeds. Seeds can be manually applied by **PPPSEED SET** or **RESTORE**, or automatically by **PPPSEED AUTO**.

The **PPPPOS** log (see page 572) will also report a solution status of PENDING if a static seed has been applied but has not yet been confirmed.

Message ID 2250

Log type: Asynch

Recommended Input

```
log pppseedapplicationstatusa onchanged
```

ASCII Example

```
#PPPSEEDAPPLICATIONSTATUSA,COM1,0,77.5,FINESTEERING,2017,505640.391,02000000,
f8c2,32768;PENDING,51.11637026243,-114.03825414820,1047.6422,0.0534,0.0523,
0.0824*3a5e7250
```

```
#PPPSEEDAPPLICATIONSTATUSA,COM1,0,75.0,FINESTEERING,2017,505680.000,02000000,
f8c2,32768;APPLIED,51.11637026243,-114.03825414820,1047.6422,0.0534,0.0523,
0.0824*390a7178
```

Field	Field Type	Description	Format	Binary Bytes	Binary Offset
1	PPPSEEDAPPLICATION STATUS header	Log header. See <i>Messages</i> on page 27 for more information.		H	0
2	Status	See <i>Table 114: PPP Seed Application Status</i> on the next page.	Enum	4	H
3	Latitude	Latitude Range: ± 90 (degrees)	Double	8	H+4
4	Longitude	Longitude Range: ± 180 (degrees)	Double	8	H+12
5	Height	Ellipsoidal height Range: > -2000 (m)	Double	8	H+20

Field	Field Type	Description	Format	Binary Bytes	Binary Offset
6	Latitude std. dev.	Latitude standard deviation (m)	Float	4	H+28
7	Longitude std. dev.	Longitude standard deviation (m)	Float	4	H+32
8	Height std. dev.	Longitude standard deviation (m)	Float	4	H+36
9	xxxx	32-bit CRC (ASCII and Binary only)	Hex	4	H+40
10	[CR][LF]	Sentence terminator (ASCII only)	-	-	-

Table 114: PPP Seed Application Status

Binary	ASCII	Description
0	UNAVAILABLE	No seed was stored in NVM
1	AVAILABLE	A seed was stored in NVM and is available for application
2	PENDING	A seed was applied but is awaiting confirmation
3	APPLIED	The seed was successfully applied
10	REJECTED_ MOTION_ DETECTED	The seed was rejected because motion was detected or explicitly set via PPPDYNAMICS DYNAMIC (see PPPDYNAMICS command on page 216)
11	REJECTED_ BAD_ POSITION	The seed was rejected because the seed position was inconsistent with the current receiver position

3.108 PPPSEEDSTORESTATUS

Status of the NVM-stored PPP seed

Platform: OEM719, OEM729, OEM7500, OEM7600, OEM7700, OEM7720, PwrPak7, SPAN CPT7, SMART7, SMART2

This log reports the availability of the PPP seed stored in NVM. When the status is **AVAILABLE**, a seed has been stored in NVM and is available for recall.

Seed storing and recall is controlled by the **PPPSEED** command (see page 218).

Message ID 2251

Log type: Asynch

Recommended Input

```
log pppseedstorestatusa onchanged
```

ASCII Example

```
#PPPSEEDSTORESTATUSA,COM1,0,76.0,FINESTEERING,2017,502402.000,02000000,edad,32768;AVAILABLE,0.071*bb8a343c
```

Field	Field Type	Description	Format	Binary Bytes	Binary Offset
1	PPPSEEDSTORESTATUS header	Log header. See <i>Messages</i> on page 27 for more information.		H	0
2	Status	Status of the stored PPP seed: 0 = UNAVAILABLE 1 = AVAILABLE	Enum	4	H
3	Horizontal std. dev.	Horizontal standard deviation (meters)	Float	4	H+4
4	xxxx	32-bit CRC (ASCII and Binary only)	Hex	4	H+8
5	[CR][LF]	Sentence terminator (ASCII only)	-	-	-

3.109 PROFILEINFO

Profile information in NVM

Platform: OEM719, OEM729, OEM7500, OEM7600, OEM7700, OEM7720, PwrPak7, SPAN CPT7, SMART7, SMART2

This log outputs a list of Profiles in the system.



A list may consist of a maximum of 20 profiles.

Message ID: 1412

Log Type: Polled

Recommended Input:

`log profileinfoa onchanged`

ASCII Examples:

```
#PROFILEINFOA,COM1,0,84.0,UNKNOWN,0,17539.339,024c0020,ae3a,10526;
"BASE",0,2,
"LOG VERSION",
"SERIALCONFIG COM2 230400"*0ad5cda5
```

Field	Field Type	Description	Format	Binary Bytes	Binary Offset
1	PROFILEINFO header	Log header. See <i>Messages</i> on page 27 for more information.	-	H	0
2	Name	Profile Name	String [Max 20]	variable 1	H
3	Status Word	Refer to <i>Table 115: Status Word</i> on the next page	Ulong	4	variable
4	# of Commands	Number of commands assigned to the Profile	Ulong	4	variable
5	Command	Profile command	String [Max 150]	variable 1	variable
6	Next command offset = variable				
7	xxxx	32-bit CRC (ASCII and Binary only)	Ulong	4	variable
8	[CR][LF]	Sentence terminator (ASCII only)	-	-	-

¹In the binary case, each string field needs to be NULL terminated and additional bytes of padding added to maintain 4-byte alignment, up to the maximum defined by the string size. The next defined field starts immediately at the next 4-byte alignment following the NULL.

Table 115: Status Word

Bit #	Mask	Description
0	0x00000001	Activate Flag (0 – Deactivate (default), 1 –Activate)
1 – 3	0x0000000E	Reserved
4	0x00000010	Command 1 validation Flag (0 – Valid (default), 1 – Invalid)
5	0x00000020	Command 2 validation Flag
6	0x00000040	Command 3 validation Flag
7	0x00000080	Command 4 validation Flag
8	0x00000100	Command 5 validation Flag
9	0x00000200	Command 6 validation Flag
10	0x00000400	Command 7 validation Flag
11	0x00000800	Command 8 validation Flag
12	0x00001000	Command 9 validation Flag
13	0x00002000	Command 10 validation Flag
14	0x00004000	Command 11 validation Flag
15	0x00008000	Command 12 validation Flag
16	0x00010000	Command 13 validation Flag
17	0x00020000	Command 14 validation Flag
18	0x00040000	Command 15 validation Flag
19	0x00080000	Command 16 validation Flag
20	0x00100000	Command 17 validation Flag
21	0x00200000	Command 18 validation Flag
22	0x00400000	Command 19 validation Flag
23	0x00800000	Command 20 validation Flag
24 - 31	0xFF000000	Reserved

3.110 PSRDOP

DOP values for the satellites used in the PSR solution

Platform: OEM719, OEM729, OEM7500, OEM7600, OEM7700, OEM7720, PwrPak7, SPAN CPT7, SMART7, SMART2

The PSRDOP log contains the Dilution Of Precision (DOP) values for the satellites being used in the PSR solution. The PSR DOPs are updated every 60 seconds or whenever the satellites used in the PSR solution changes.

DOP values are a measure of the solution strength. Essentially, the DOPs reflect the geometry of the satellites used in the solution. Solutions with good counts of well-distributed satellites will have low DOPs and should be accurate and reliable. Solutions with fewer or poorly-distributed satellites will have high DOPs and be less accurate and reliable. As a rough guideline, PDOP values less than 4 imply a solution with reasonable geometry.

There can be many reasons for high DOP values. The most common reason is that there are obstructions limiting satellite visibility. Even if satellites are visible and being tracked they might still not be used in the solution if, for example, they are unhealthy or there are not corrections available for them. The **PSRSATS** log (see page 587) will inform which satellites are being tracked and explain why a tracked satellite is not used in the solution.

The DOPs do not consider that different satellites or signals will be weighted differently in the solution. Therefore, they do not completely reflect the solution quality. Ultimately, the standard deviations reported in the **PSRPOS** log (see page 585) are the best reflection of the solution accuracy.



1. If a satellite is locked out using the **LOCKOUT** command (see page 172), it will still show in the prn list but it will be significantly deweighted in the dop calculation.
2. The vertical dilution of precision can be calculated by:

$$vdop = \sqrt{pdop^2 - hdop^2}$$
3. If the DOP is not yet calculated, a default value of 9999.0 is displayed.

Message ID: 174

Log Type: Asynch

Recommended Input:

```
log psrdopa onchanged
```

ASCII Example:

```
#PSRDOPA,COM1,0,56.5,FINESTEERING,1337,403100.000,02000000,768f,1984;1.9695,1.7613,1.0630,1.3808,0.8812,5.0,10,14,22,25,1,24,11,5,20,30,7*106de10a
```

Field	Field type	Format	Binary Bytes	Binary Offset
1	PSRDOP header	Log header. See <i>Messages</i> on page 27 for more information.	H	0

Field	Field type		Format	Binary Bytes	Binary Offset
2	gdop	Geometric dilution of precision - assumes 3D position and receiver clock offset (all 4 parameters) are unknown	Float	4	H
3	pdop	Position dilution of precision - assumes 3D position is unknown and receiver clock offset is known	Float	4	H+4
4	hdop	Horizontal dilution of precision.	Float	4	H+8
5	htdop	Horizontal position and time dilution of precision.	Float	4	H+12
6	tdop	Time dilution of precision - assumes 3D position is known and only the receiver clock offset is unknown	Float	4	H+16
7	cutoff	GPS elevation cut-off angle	Float	4	H+20
8	#PRN	Number of satellites PRNs to follow	Long	4	H+24
9	PRN	PRN of SV PRN tracking, null field until position solution available	Ulong	4	H+28
10...	Next PRN offset = $H+28+(\#prn \times 4)$				
11	xxxx	32-bit CRC (ASCII and Binary only)	Ulong	4	H+28+ (#prn x 4)
12	[CR] [LF]	Sentence terminator (ASCII only)	-	-	-

3.111 PSRDOP2

DOP values for the satellites used in the PSR solution

Platform: OEM719, OEM729, OEM7500, OEM7600, OEM7700, OEM7720, PwrPak7, SPAN CPT7, SMART7, SMART2

The PSRDOP2 log contains the Dilution Of Precision (DOP) values for the satellites being used in the PSR solution. This log is similar to the **PSRDOP** log (see page 581) but contains the per-system TDOPs; see the **PSRDOP** log on page 581 for more information on the DOPs.

Message ID: 1163

Log Type: Asynch

Recommended Input:

```
log psrdop2a onchanged
```

ASCII Example:

```
#PSRDOP2A,COM1,0,89.5,FINESTEERING,1613,164820.000,02000008,0802,39031;1.6740,1.3010,0.6900,1.1030,2,GPS,0.6890,GLONASS,0.7980*5dd123d0.
```

Field	Field type	Description	Format	Binary Bytes	Binary Offset
1	PSRDOP2 header	Log header. See <i>Messages</i> on page 27 for more information.		H	0
2	GDOP	Geometric dilution of precision - assumes 3D position and receiver clock offset (all 4 parameters) are unknown	Float	4	H
3	PDOP	Position dilution of precision - assumes 3D position is unknown and receiver clock offset is known	Float	4	H+4
4	HDOP	Horizontal dilution of precision	Float	4	H+8
5	VDOP	Vertical dilution of precision	Float	4	H+12
6	#systems	Number of systems	Ulong	4	H+16
7	system	See <i>Table 116: System Used for Timing</i> on the next page	Enum	4	H+20
8	TDOP	Time dilution of precision	Float	4	H+24
9	Next satellite offset = H+20+(#systems x 8)				
10	xxxx	32-bit CRC (ASCII and Binary only)	Hex	4	H+20+ (#systems x 8)
11	[CR][LF]	Sentence terminator (ASCII only)	-	-	-

Table 116: System Used for Timing

Binary	ASCII
0	GPS
1	GLONASS
2	GALILEO
3	BEIDOU
4	NAVIC
99	AUTO ¹

¹AUTO is used only as a backup system (not available for primary system field).

3.112 PSRPOS

Pseudorange position

Platform: OEM719, OEM729, OEM7500, OEM7600, OEM7700, OEM7720, PwrPak7, SPAN CPT7, SMART7, SMART2

This log contains the position computed by the receiver, along with three status flags. In addition, it reports other status indicators, including differential age, which is useful in predicting anomalous behavior brought about by outages in differential corrections.

Message ID: 47

Log Type: Synch

Recommended Input:

```
log psrposa ontime 1
```

ASCII Example:

```
#PSRPOSA,COM1,0,58.5,FINESTEERING,1419,340037.000,02000040,6326,2724;  
SOL_COMPUTED,SINGLE,51.11636177893,-114.03832396506,1062.5470,-16.2712,WGS84,  
1.8532,1.4199,3.3168,"",0.000,0.000,12,12,0,0,0,06,0,33*d200a78c
```



There are DGPS use cases in which the base receiver is not maintained or controlled by the positioning user. For example, the US Coast Guard operates a differential correction service which broadcasts GPS differential corrections over marine radio beacons. As a user, all you need is a marine beacon receiver and a GNSS receiver to achieve positioning accuracy of less than 1 meter. In this case, the Coast Guard owns and operates the base receiver at known coordinates. Other examples of users appearing to use only one GNSS receiver include FM radio station correction services, privately owned radio transmitters and corrections carried by communication satellites. Some of the radio receivers have built-in GNSS receivers and combined antennas, so they even appear to look as one self-contained unit.

The major factors degrading GPS signals which can be removed or reduced with differential methods are the atmosphere, ionosphere, satellite orbit errors, and satellite clock errors. Some errors which are not removed include receiver noise and multipath.

Field	Field type	Description	Format	Binary Bytes	Binary Offset
1	PSRPOS header	Log header. See <i>Messages</i> on page 27 for more information.		H	0
2	sol status	Solution status (see <i>Table 65: Solution Status</i> on page 374)	Enum	4	H
3	pos type	Position type (see <i>Table 66: Position or Velocity Type</i> on page 375)	Enum	4	H+4
4	lat	Latitude (degrees)	Double	8	H+8

Field	Field type	Description	Format	Binary Bytes	Binary Offset
5	lon	Longitude (degrees)	Double	8	H+16
6	hgt	Height above mean sea level (m)	Double	8	H+24
7	undulation	Undulation - the relationship between the geoid and the WGS84 ellipsoid (m) ¹	Float	4	H+32
8	datum id#	Datum ID number 61 = WGS84 63 = USER	Enum	4	H+36
9	lat σ	Latitude standard deviation (m)	Float	4	H+40
10	lon σ	Longitude standard deviation (m)	Float	4	H+44
11	hgt σ	Height standard deviation (m)	Float	4	H+48
12	stn id	Base station ID	Char[4]	4	H+52
13	diff_age	Differential age in seconds	Float	4	H+56
14	sol_age	Solution age in seconds	Float	4	H+60
15	#SVs	Number of satellites tracked	Uchar	1	H+64
16	#solnSVs	Number of satellite vehicles used in solution	Uchar	1	H+65
17	Reserved		Uchar	1	H+66
18			Uchar	1	H+67
19			Hex	1	H+68
20	ext sol stat	Extended solution status (see <i>Table 69: Extended Solution Status</i> on page 378)	Hex	1	H+69
21	Galileo and BeiDou sig mask	Galileo and BeiDou signals used mask (see <i>Table 68: Galileo and BeiDou Signal-Used Mask</i> on page 378)	Hex	1	H+70
22	GPS and GLONASS sig mask	GPS and GLONASS signals used mask (see <i>Table 67: GPS and GLONASS Signal-Used Mask</i> on page 377)	Hex	1	H+71
23	xxxx	32-bit CRC (ASCII and Binary only)	Hex	4	H+72
24	[CR][LF]	Sentence terminator (ASCII only)	-	-	-

¹When using a datum other than WGS84, the undulation value also includes the vertical shift due to differences between the datum in use and WGS84.

3.113 PSRSATS

Satellites used in PSRPOS solution

Platform: OEM719, OEM729, OEM7500, OEM7600, OEM7700, OEM7720, PwrPak7, SPAN CPT7, SMART7, SMART2

This log lists the used and unused satellites for the corresponding PSRPOS solution. It also describes the signals of the used satellites and reasons for exclusions.

Message ID: 1162

Log Type: Synch

Recommended Input:

```
log psrsats ontime 1
```

Abbreviated ASCII Example:

```
<PSRSATS COM1 0 80.0 FINESTEERING 1729 154910.000 02004000 fea4 11465
< 20
< GPS 31 GOOD 00000003
< GPS 14 GOOD 00000003
< GPS 22 GOOD 00000003
< GPS 11 GOOD 00000003
< GPS 1 GOOD 00000003
< GPS 32 GOOD 00000003
< GPS 18 GOOD 00000003
< GPS 24 GOOD 00000003
< GPS 19 GOOD 00000003
< GLONASS 24+2 GOOD 00000003
< GLONASS 10-7 GOOD 00000003
< GLONASS 9-2 GOOD 00000003
< GLONASS 2-4 GOOD 00000003
< GLONASS 1+1 GOOD 00000003
< GLONASS 11 GOOD 00000003
< GLONASS 17+4 GOOD 00000003
< GLONASS 18-3 GOOD 00000003
< GALILEO 12 LOCKEDOUT 00000000
< GALILEO 11 LOCKEDOUT 00000000
< BEIDOU 8 GOOD 00000003
```

Field	Field type	Description	Format	Binary Bytes	Binary Offset
1	PSRSATS header	Log header. See <i>Messages</i> on page 27 for more information.		H	0
2	#entries	Number of records to follow	Ulong	4	H
3	system	See <i>Table 93: Satellite System</i> on page 477	Enum	4	H+4

Field	Field type	Description	Format	Binary Bytes	Binary Offset
4	Satellite ID	Satellite identifier	Ulong	4	H+8
5	Status	Satellite status (see <i>Table 71: Observation Statuses</i> on page 381)	Enum	4	H+12
6	Signal mask	See <i>Table 72: BESTSATS GPS Signal Mask</i> on page 382, <i>Table 73: BESTSATS GLONASS Signal Mask</i> on page 383, <i>Table 74: BESTSATS Galileo Signal Mask</i> on page 383, and <i>Table 75: BESTSATS BeiDou Signal Mask</i> on page 383	Hex	4	H+16
7	Next satellite offset = H+4+(#sat x 16)				
8	xxxx	32-bit CRC (ASCII and Binary only)	Hex	4	H+4+ (#sat x 16)
9	[CR][LF]	Sentence terminator (ASCII only)	-	-	-

3.114 PSRVEL

Pseudorange velocity

Platform: OEM719, OEM729, OEM7500, OEM7600, OEM7700, OEM7720, PwrPak7, SPAN CPT7, SMART7, SMART2

In the PSRVEL log, the actual speed and direction of the receiver antenna over ground is provided. The velocity measurements sometimes have a latency associated with them. The time of validity is the time tag in the log minus the latency value.



In a PSRVEL log, the actual speed and direction of the receiver antenna over ground is provided. The receiver does not determine the direction a vessel, craft or vehicle is pointed (heading) but rather the direction of motion of the GNSS antenna relative to ground.

The velocity in the PSRVEL log is determined by the pseudorange filter. Velocities from the pseudorange filter are calculated from the Doppler.

The velocity status indicates varying degrees of velocity quality. To ensure healthy velocity, the velocity sol-status must also be checked. If the sol-status is non-zero, the velocity is likely invalid. It should be noted that the receiver does not determine the direction a vessel, craft, or vehicle is pointed (heading), but rather the direction of the motion of the GPS antenna relative to the ground.

The latency of the instantaneous Doppler velocity is always 0.15 seconds. The latency represents an estimate of the delay caused by the tracking loops under acceleration of approximately 1 G. For most users, the latency can be assumed to be zero (instantaneous velocity).

Message ID: 100

Log Type: Synch

Recommended Input:

```
log psrvela ontime 1
```

ASCII Example:

```
#PSRVELA, COM1, 0, 52.5, FINESTEERING, 1337, 403362.000, 02000000, 658b, 1984;  
SOL_COMPUTED, PSRDIFF, 0.250, 9.000, 0.0698, 26.582692, 0.0172, 0.0*a94e5d48
```



Consider the case where vehicles are leaving a control center. The control center's coordinates are known but the vehicles are on the move. Using the control center's position as a reference, the vehicles are able to report where they are with PSRPOS and their speed and direction with PSRVEL at any time.

Field	Field type	Description	Format	Binary Bytes	Binary Offset
1	PSRVEL header	Log header. See <i>Messages</i> on page 27 for more information.		H	0

Field	Field type	Description	Format	Binary Bytes	Binary Offset
2	sol status	Solution status, see <i>Table 65: Solution Status</i> on page 374	Enum	4	H
3	vel type	Velocity type, see <i>Table 66: Position or Velocity Type</i> on page 375	Enum	4	H+4
4	latency	A measure of the latency in the velocity time tag in seconds. It should be subtracted from the time to give improved results	Float	4	H+8
5	age	Differential age in seconds	Float	4	H+12
6	hor spd	Horizontal speed over ground, in meters per second	Double	8	H+16
7	trk gnd	Actual direction of motion over ground (track over ground) with respect to True North, in degrees	Double	8	H+24
8	vert spd	Vertical speed, in meters per second, where positive values indicate increasing altitude (up) and negative values indicate decreasing altitude (down)	Double	8	H+32
9	Reserved		Float	4	H+40
10	xxxx	32-bit CRC (ASCII and Binary only)	Ulong	4	H+44
11	[CR] [LF]	Sentence terminator (ASCII only)	-	-	-

3.115 PSRXYZ

Pseudorange Cartesian position and velocity

Platform: OEM719, OEM729, OEM7500, OEM7600, OEM7700, OEM7720, PwrPak7, SPAN CPT7, SMART7, SMART2

This log contains the receiver's pseudorange position and velocity in ECEF coordinates. The position and velocity status field's indicate whether or not the corresponding data is valid. See *Figure 6: The WGS84 ECEF Coordinate System* on page 392 for a definition of the ECEF coordinates.

The velocity status indicates varying degrees of velocity quality. To ensure healthy velocity, the velocity sol-status must also be checked. If the sol-status is non-zero, the velocity is likely invalid. It should be noted that the receiver does not determine the direction a vessel, craft or vehicle is pointed (heading) but rather the direction of the motion of the GNSS antenna relative to the ground.

The latency of the instantaneous Doppler velocity is always 0.15 seconds. The latency represents an estimate of the delay caused by the tracking loops under acceleration of approximately 1 G. For most users, the latency can be assumed to be zero (instantaneous velocity).

Message ID: 243

Log Type: Synch

Recommended Input:

```
log psrxyza ontime 1
```

ASCII Example:

```
#PSRXYZA,COM1,0,58.5,FINESTEERING,1419,340038.000,02000040,4a28,2724;  
SOL_COMPUTED,SINGLE,-1634530.7002,-3664617.2823,4942495.5175,1.7971,2.3694,  
2.7582,SOL_COMPUTED,DOPPLER_VELOCITY,0.0028,0.0231,-0.0120,0.2148,0.2832,  
0.3297,"",0.150,0.000,0.000,12,12,0,0,0,06,0,33*4fdbcd1
```



The instantaneous Doppler is the measured Doppler frequency which consists of the satellite's motion relative to the receiver (Satellite Doppler + User Doppler) and the clock (local oscillator) drift.

Field	Field type	Description	Format	Binary Bytes	Binary Offset
1	PSRXYZ header	Log header. See <i>Messages</i> on page 27 for more information.		H	0
2	P-sol status	Solution status, see <i>Table 65: Solution Status</i> on page 374	Enum	4	H
3	pos type	Position type, see <i>Table 66: Position or Velocity Type</i> on page 375	Enum	4	H+4
4	P-X	Position X-coordinate (m)	Double	8	H+8

Field	Field type	Description	Format	Binary Bytes	Binary Offset
5	P-Y	Position Y-coordinate (m)	Double	8	H+16
6	P-Z	Position Z-coordinate (m)	Double	8	H+24
7	P-X σ	Standard deviation of P-X (m)	Float	4	H+32
8	P-Y σ	Standard deviation of P-Y (m)	Float	4	H+36
9	P-Z σ	Standard deviation of P-Z (m)	Float	4	H+40
10	V-sol status	Solution status, see <i>Table 65: Solution Status</i> on page 374	Enum	4	H+44
11	vel type	Velocity type, see <i>Table 66: Position or Velocity Type</i> on page 375	Enum	4	H+48
12	V-X	Velocity vector along X-axis (m/s)	Double	8	H+52
13	V-Y	Velocity vector along Y-axis (m/s)	Double	8	H+60
14	V-Z	Velocity vector along Z-axis (m/s)	Double	8	H+68
15	V-X σ	Standard deviation of V-X (m/s)	Float	4	H+76
16	V-Y σ	Standard deviation of V-Y (m/s)	Float	4	H+80
17	V-Z σ	Standard deviation of V-Z (m/s)	Float	4	H+84
18	stn ID	Base station ID	Char[4]	4	H+88
19	V-latency	A measure of the latency in the velocity time tag in seconds. It should be subtracted from the time to give improved results	Float	4	H+92
20	diff_age	Differential age in seconds	Float	4	H+96
21	sol_age	Solution age in seconds	Float	4	H+100
22	#SVs	Number of satellites tracked	Uchar	1	H+104
23	#solnSVs	Number of satellite vehicles used in solution	Uchar	1	H+105
24	Reserved		Char	1	H+106
25			Char	1	H+107
26			Char	1	H+108
27	ext sol stat	Extended solution status (see <i>Table 69: Extended Solution Status</i> on page 378)	Hex	1	H+109

Field	Field type	Description	Format	Binary Bytes	Binary Offset
28	Galileo and BeiDou sig mask	Galileo and BeiDou signals used mask (see <i>Table 68: Galileo and BeiDou Signal-Used Mask</i> on page 378)	Hex	1	H+110
29	GPS and GLONASS sig mask	GPS and GLONASS signals used mask (see <i>Table 67: GPS and GLONASS Signal-Used Mask</i> on page 377)	Hex	1	H+111
30	xxxx	32-bit CRC (ASCII and Binary only)	Hex	4	H+112
31	[CR][LF]	Sentence terminator (ASCII only)	-	-	-

3.116 QZSSALMANAC

Decoded QZSS Almanac parameters

Platform: OEM719, OEM729, OEM7500, OEM7600, OEM7700, OEM7720, PwrPak7, SPAN CPT7, SMART7, SMART2

This log contains the decoded L1 C/A almanac parameters as received from the satellite with the parity information removed and appropriate scaling applied.

The OEM7 family of receivers automatically save almanacs in their Non-Volatile Memory (NVM), so creating an almanac boot file is not necessary.



For more information about QZSS almanac data, refer to the Interface Specifications for QZSS at <http://qzss.go.jp/en/technical/ps-is-qzss/ps-is-qzss.html>.

Message ID: 1346

Log Type: Asynch

Recommended Input:

```
log qzssalmanaca onchanged
```

ASCII Example:

```
#QZSSALMANACA,COM1,0,89.5,SATTIME,1642,148584.000,02000008,67d2,39655;1,193,
1642,208896.0,7.587582e-02,-2.94869425e-09,-1.4441238e+00,-1.5737385e+00,
1.7932513e+00,0.00000000,0.00000000,7.29336435e-05,4.2159360e+07,
7.11809030e-01,7,7*fb648921
```



The speed at which the receiver locates and locks onto new satellites is improved if the receiver has approximate time and position (**SETAPPROXTIME** and **SETAPPROXPOS**), as well as an almanac. This allows the receiver to compute the elevation of each satellite so it can tell which satellites are visible and their Doppler offsets, improving Time to First Fix (TTFF).

Field	Field Type	Description	Format	Binary Bytes	Binary Offset
1	QZSSALMANAC Header	Log header. See <i>Messages</i> on page 27 for more information.		H	0
2	#messages	Number of satellite PRN almanac messages to follow. Set to zero until almanac data is available	Ulong	4	H
3	PRN	Satellite PRN number for current message (dimensionless)	Ulong	4	H+4
4	week	Almanac reference week	Ulong	4	H+8

Field	Field Type	Description	Format	Binary Bytes	Binary Offset
5	seconds	Almanac reference time (s)	Double	8	H+12
6	ecc	Eccentricity (dimensionless)	Double	8	H+20
7	$\dot{\omega}$	Rate of right ascension (radians/s)	Double	8	H+28
8	ω_0	Right, ascension (radians)	Double	8	H+36
9	ω	Argument of perigee (radians)	Double	8	H+44
10	M_0	Mean anomaly of reference time (radians)	Double	8	H+52
11	a_{f0}	Clock aging parameter (s)	Double	8	H+60
12	a_{f1}	Clock aging parameter (s/s)	Double	8	H+68
13	N	Corrected mean motion (radians/s)	Double	8	H+76
14	A	Semi-major axis (m)	Double	8	H+84
15	inclination angle	Angle of inclination	Double	8	H+92
16	health-prn	SV health from Page 25 of subframe 4 or 5 (6 bits)	Ulong	4	H+100
17	health-alm	SV health from almanac (8 bits)	Ulong	4	H+104
18	Next PRN offset = H+4+(#messages x 104)				
19	xxxx	32-bit CRC (ASCII and Binary only)	Ulong	4	H+4+ (#messages x 104)
20	[CR][LF]	Sentence terminator (ASCII only)	-	-	-

3.117 QZSSEPHEMERIS

Decoded QZSS parameters

Platform: OEM719, OEM729, OEM7500, OEM7600, OEM7700, OEM7720, PwrPak7, SPAN CPT7, SMART7, SMART2

This log contains a single set of QZSS L1 C/A ephemeris parameters.

Message ID: 1336

Log Type: Asynch

Recommended Input:

```
log qzssephemerisa onchanged
```

ASCII Example:

```
#QZSSEPHEMERISA,COM1,0,93.5,SATTIME,1642,153690.000,02000008,1e9d,39655;193,
153690.000000000,7,201,201,1642,1642,154800.000000000,4.216030971806980e+07,
2.115802417e-09,-2.152109479,0.075863329,-1.573817810,-0.000007546,0.000009645,
-177.375000000,-219.875000000,-0.000000797,-0.000002151,0.711859299,
-2.978695503e-10,-1.443966112,-1.636139580e-09,713,154800.000000000,
-5.122274160e-09,-0.000000163,1.250555215e-12,0.000000000,FALSE,
0.000072933,4.000000000,0,0,0,0*fb52c7f
```

Field	Field Type	Description	Format	Binary Bytes	Binary Offset
1	QZSSEPHEMERIS header	Log header. See <i>Messages</i> on page 27 for more information.		H	0
2	PRN	Satellite PRN number	Ulong	4	H
3	tow	Time stamp of subframe 0 (s)	Double	8	H+4
4	health	Health status - a 6-bit health code as defined in QZSS Interface Specification	Ulong	4	H+12
5	IODE1	Issue of ephemeris data 1	Ulong	4	H+16
6	IODE2	Issue of ephemeris data 2	Ulong	4	H+20
7	week	GPS reference week number	Ulong	4	H+24
8	z week	Z count week number. This is the week number from subframe 1 of the ephemeris. The 'toe week' (field #7) is derived from this to account for rollover	Ulong	4	H+28
9	toe	Reference time for ephemeris (s)	Double	8	H+32
10	A	Semi-major axis (m)	Double	8	H+40
11	ΔN	Mean motion difference (radians/s)	Double	8	H+48

Field	Field Type	Description	Format	Binary Bytes	Binary Offset
12	M_0	Mean anomaly of reference time (radius)	Double	8	H+56
13	ecc	Eccentricity (dimensionless)	Double	8	H+64
14	ω	Argument of perigee (radians)	Double	8	H+72
15	cuc	Amplitude of cosine harmonic correction term to the argument of latitude (radians)	Double	8	H+80
16	cus	Amplitude of sine harmonic correction term to the argument of latitude (radians)	Double	8	H+88
17	crc	Amplitude of cosine harmonic correction term to the orbit radius (m)	Double	8	H+96
18	crs	Amplitude of sine harmonic correction term to the orbit radius (m)	Double	8	H+104
19	cic	Amplitude of cosine harmonic correction term to the angle of inclination (radians)	Double	8	H+112
20	cis	Amplitude of sine harmonic correction term to the angle of inclination (radians)	Double	8	H+120
21	I_0	Inclination angle at reference time (radians)	Double	8	H+128
22	\dot{I}	Rate of inclination angle (radians/s)	Double	8	H+136
23	ω_0	Right ascension (radians)	Double	8	H+144
24	$\dot{\omega}$	Rate of right ascension (radians/s)	Double	8	H+152
25	iodc	Issue of data clock	Ulong	4	H+160
26	toc	SV clock correction term (s)	Double	8	H+164
27	tgd	Estimated group delay difference (s)	Double	8	H+172
28	a_{f0}	Clock aging parameter (s)	Double	8	H+180
29	a_{f1}	Clock aging parameter (s/s)	Double	8	H+188
30	a_{f2}	Clock aging parameter (s/s/s)	Double	8	H+196
31	AS	Anti-spoofing on: 0= FALSE 1=TRUE	Enum	4	H+204
32	N	Corrected mean motion (radians/s)	Double	8	H+208

Field	Field Type	Description	Format	Binary Bytes	Binary Offset
33	URA	User Range Accuracy variance, m ² . The ICD specifies that the URA index transmitted in the ephemerides can be converted to a nominal standard deviation value using an algorithm listed there. We publish the square of the nominal value (variance)	Double	8	H+216
34	Fit Interval	Curve fit interval: 0 = Ephemeris data are effective for 2 hours 1 = Ephemeris data are effective for more than 2 hours	Uchar	1	H+224
35	Reserved		Uchar	1	H+225
36	Reserved		Uchar	1	H+226
37	Reserved		Uchar	1	H+227
38	xxxx	32-bit CRC (ASCII and Binary only)	Ulong	4	H+228
39	[CR][LF]	Sentence terminator (ASCII only)	-	-	-

3.118 QZSSIONUTC

QZSS ionospheric and time information

Platform: OEM719, OEM729, OEM7500, OEM7600, OEM7700, OEM7720, PwrPak7, SPAN CPT7, SMART7, SMART2

This log contains the Ionospheric Model parameters (ION) and the Universal Time Coordinated parameters (UTC) for QZSS.

Message ID: 1347

Log Type: Asynch

Recommended Input:

```
log qzssionutca onchanged
```

ASCII Example:

```
#QZSSIONUTCA,COM1,0,94.0,FINESTEERING,1642,153300.565,02480008,158b,39655;  
1.396983861923218e-08,-6.705522537231444e-8,0.000000000000000e+000,  
1.788139343261719e-07,8.396800000000000e+04,7.536640000000000e+05,  
-7.864320000000000e+05,-6.946816000000000e+06,1642,307200,  
-5.5879354476928711e-09,5.329070518e-15,1768,4,15,15,0*0204eec1
```

Field	Field Type	Description	Format	Binary Bytes	Binary Offset
1	QZSSIONUTC Header	Log header. See <i>Messages</i> on page 27 for more information.		H	0
2	a0	Alpha parameter constant term	Double	8	H
3	a1	Alpha parameter 1st order term	Double	8	H+8
4	a2	Alpha parameter 2nd order term	Double	8	H+16
5	a3	Alpha parameter 3rd order term	Double	8	H+24
6	b0	Beta parameter constant term	Double	8	H+32
7	b1	Beta parameter 1st order term	Double	8	H+40
8	b2	Beta parameter 2nd order term	Double	8	H+48
9	b3	Beta parameter 3rd order term	Double	8	H+56
10	utc wn	UTC reference week number	Ulong	4	H+64
11	tot	Reference time of UTC parameters (s)	Ulong	4	H+68
12	A0	UTC constant term of polynomial (s)	Double	8	H+72
13	A1	UTC 1st order term of polynomial (s/s)	Double	8	H+80
14	wn Isf	Future week number	Ulong	4	H+88

Field	Field Type	Description	Format	Binary Bytes	Binary Offset
15	dn	Day number (the range is 1 to 7 where Sunday=1 and Saturday=7)	Ulong	4	H+92
16	deltat ls	Delta time due to leap seconds	Long	4	H+96
17	deltat lsf	Future delta time due to leap seconds	Long	4	H+100
18	Reserved			4	H+104
19	xxxx	32-bit CRC (ASCII and Binary only)	Ulong	4	H+108
20	[CR][LF]	Sentence terminator (ASCII only)	-	-	-

3.119 QZSSRAWALMANAC

Raw QZSS almanac data

Platform: OEM719, OEM729, OEM7500, OEM7600, OEM7700, OEM7720, PwrPak7, SPAN CPT7, SMART7, SMART2

This log contains the undecoded L1 C/A almanac subframes as received from the QZSS satellite.

Message ID: 1345

Log Type: Asynch

Recommended Input:

```
log qzssrawalmanaca onchanged
```

ASCII Example:

```
#QZSSRAWALMANACA, COM1, 0, 93.5, SATTIME, 1642, 153300.000, 02480008, 64c4, 39655;1642,
208896.000, 7,
1, 8b000031c390c1820e33d007fefe07cae831c5293ebfe15049104a000001,
51, 8b000031c613f3336a1fffffffffffffffffffffffffffffffffffffffff000000,
49, 8b000031cd90f14e6a7cf3cf1cf1cf3cf3c73cf1cf1cf3cf3cf3cf000002,
50, 8b000031ce14f24e6a0cf3cf1df1cfffffffffffffffffffffffffffffffff000002,
56, 8b000031d511f80ff70003292ef496000006fffffffffa4b6a0fe8040f0002,
52, 8b000031e692f4a00a0fff83f060f2080180082082082082082002080381,
53, 8b000031e717f58082082082082082082082082082082082082082080
*ca4596f9l
```



The OEM7 family of receivers automatically saves almanacs in their Non-Volatile Memory (NVM), therefore creating an almanac boot file is not necessary.

Field	Field Type	Description	Format	Binary Bytes	Binary Offset
1	QZSSRAW ALMANAC header	Log header. See <i>Messages</i> on page 27 for more information.		H	0
2	ref week	Almanac reference week number	Ulong	4	H
3	ref secs	Almanac reference time, in milliseconds (binary data) or seconds (ASCII data)	GPSec	4	H+4
4	#subframes	Number of subframes to follow	Ulong	4	H+8
5	svid	SV ID (satellite vehicle ID) SV ID 1 to 10 corresponds to QZSS PRN 193 to 202. Any other values indicate the page ID. Refer to QZSS Interface Specification for more details.	Hex	2	H+12

Field	Field Type	Description	Format	Binary Bytes	Binary Offset
6	data	Subframe page data	Hex	30	H+14
7	Next subframe offset = $H+12+(\text{\#subframe} \times 32)$				
8	xxxx	32-bit CRC (ASCII and Binary only)	Hex	4	H+12+ (#subframes x 32)
9	[CR][LF]	Sentence terminator (ASCII only)	-	-	-

3.120 QZSSRAWCNAVMESSAGE

Raw QZSS L2C and L5 CNAV message

Platform: OEM719, OEM729, OEM7500, OEM7600, OEM7700, OEM7720, PwrPak7, SPAN CPT7, SMART7, SMART2

This log provides the raw QZSS L2C and L5 CNAV message.

Message ID: 1530

Log Type: Collection

Recommended Input:

```
log qzssrawcnavmessage onnew
```

ASCII Example:

```
#QZSSRAWCNAVMESSAGEA,COM1,0,66.5,SATTIME,1902,405696.000,02000020,20f7,13677;40,193,10,8b04a84110edc2a346a97d311c3ff854620220004eba94f1313134f005530056c9da0cc2300*1f2abac5
```

Field	Field type	Description	Format	Binary Bytes	Binary Offset
1	QZSSRAWCNAVMESSAGE header	Log header. See <i>Messages</i> on page 27 for more information.	-	H	0
2	signal channel	Signal channel providing the bits	Ulong	4	H
3	PRN	QZSS satellite PRN number	Ulong	4	H+4
4	message ID	CNAV message ID	Ulong	4	H+8
5	data	CNAV raw message data	Hex[38]	38	H+12
6	xxxx	32-bit CRC (ASCII and Binary only)	Hex	4	H+50
7	[CR][LF]	Sentence terminator (ASCII only)	-	-	-

3.122 QZSSRAWSUBFRAME

Raw QZSS subframe data

Platform: OEM719, OEM729, OEM7500, OEM7600, OEM7700, OEM7720, PwrPak7, SPAN CPT7, SMART7, SMART2

This log contains the raw QZSS subframe data.

A raw QZSS subframe is 300 bits in total, 10 words of 30 bits each. This includes the parity 6 bits at the end of each word, for a total of 60 parity bits. Note that in Field #4, the 'data' field below, the 60 parity bits are stripped out and only the raw subframe data remains, for a total of 240 bits. There are two bytes added onto the end of this 30 byte packed binary array to pad out the entire data structure to 32 bytes in order to maintain 4 byte alignment.

Message ID: 1330

Log Type: Asynch

Recommended Input:

```
log qzssrawsubframea onnew
```

ASCII Example:

```
#QZSSRAWSUBFRAMEA,COM1,0,85.5,SATTIME,1642,230604.000,02000008,e56b,39655;193,5,8b00004b11970637984efbf7fd4d0fa10ca49631ace140740a08fe0dfd43,65*6a7b9123
```

Field	Field Type	Description	Format	Binary Bytes	Binary Offset
1	QZSSRAW SUBFRAME header	Log header. See <i>Messages</i> on page 27 for more information.		H	0
2	PRN	Satellite PRN number	Ulong	4	H
3	subframe ID	Subframe ID	Ulong	4	H+4
4	data	Raw subframe data	Hex [30]	32 ¹	H+8
5	chan	Signal channel number that the frame was decoded on	Ulong	4	H+40
6	xxxx	32-bit CRC (ASCII and Binary only)	Ulong	4	H+44
7	[CR][LF]	Sentence terminator	-	-	-

¹In the binary log case, an additional 2 bytes of padding are added to maintain 4-byte alignment.

3.123 RADARSTATUS

Emulated Radar Signal Information

Platform: OEM719, OEM729, OEM7500, OEM7600, OEM7700, OEM7720, PwrPak7, SPAN CPT7, SMART7, SMART2

This log provides information on the velocity and Emulated Radar (ER) signal.

Message ID: 1877

Log Type: Synch

Recommended Input:

```
log radarstatusa ontime 1
```

ASCII Example:

```
#RADARSTATUSA,COM1,0,39.0,FINESTEERING,3189,201903.000,00040020,3a93,32768;000000F,SOL_COMPUTED,DOPPLER_VELOCITY,5.5924,5.1682,671.842775*9a017aff
```

Field	Field Type	Description	Format	Binary Bytes	Binary Offset
1	RADARSTATUS Header	Log header. See <i>Messages</i> on page 27 for more information.	-	H	0
2	Emulated radar status	Bit field representing current state of radar emulation <i>Table 117: Emulated Radar Status</i> on the next page	Hex	4	H
3	Solution status	Solution status as reported in BESTVEL log on page 387	Enum	4	H+4
4	Velocity type	Velocity type as reported in BESTVEL log on page 387	Enum	4	H+8
5	Hor speed	Horizontal speed over ground (m/sec)	Double	8	H+12
6	Smooth hor speed	Smoother horizontal speed over ground (m/sec)	Enum	4	H+20
7	Frequency	Output frequency (Hz)	Double	8	H+28

Table 117: Emulated Radar Status

Bit	Mask	Description
0	0x01	Feature enabled
1	0x02	Velocity type good
2	0x04	Velocity >1 kph
3-4	0x18	<p>Current response mode being applied will equal the RADARCONFIG command on page 230 response mode parameter unless it is 2. If response mode is set to 2 in the RADARCONFIG command , this will be either 500 or 1000, depending on speed.</p> <p>Mapped as follows:</p> <ul style="list-style-type: none"> - 00: Response mode 1 (no smoothing) - 01: Response mode 500 (500 ms smoothing) - 10: Response mode 1000 (1000 ms smoothing) - 11: Response mode 2000 (2000 ms smoothing)
5-31	0xFFFFE700	Reserved

3.124 RAIMSTATUS

RAIM status

Platform: OEM719, OEM729, OEM7500, OEM7600, OEM7700, OEM7720, PwrPak7, SPAN CPT7, SMART7, SMART2

This log provides information on Receiver Autonomous Integrity Monitoring (RAIM) status.

Message ID: 1286

Log Type: Synch

Recommended Input:

```
log raimstatusa ontime 1
```

ASCII Example:

```
#RAIMSTATUSA,COM1,0,88.5,FINESTEERING,1837,268443.500,02040008,bf2d,32768;DEFAU  
LT,PASS,NOT_AVAILABLE,0.000,NOT_AVAILABLE,0.000,1,GLONASS,10-7*6504be7b
```

Field	Field Type	Description	Format	Binary Bytes	Binary Offset
1	RAIMSTATUS Header	Log header. See <i>Messages</i> on page 27 for more information.	-	H	0
2	RAIM Mode	RAIM mode (refer to <i>Table 118: RAIM Mode Types</i> on the next page)	Enum	4	H
3	Integrity status	Integrity Status (see <i>Table 119: Integrity Status</i> on the next page)	Enum	4	H+4
4	HPL status	Horizontal protection level status (see <i>Table 120: Protection Level Status</i> on page 610)	Enum	4	H+8
5	HPL	Horizontal protection level (m)	Double	8	H+12
6	VPL status	Vertical protection level status (see <i>Table 120: Protection Level Status</i> on page 610)	Enum	4	H+20
7	VPL	Vertical protection level (m)	Double	8	H+24
8	#SVs	Number of excluded satellites	Ulong	4	H+32
9	System	Satellite system (see <i>Table 93: Satellite System</i> on page 477)	Enum	4	H+36

Field	Field Type	Description	Format	Binary Bytes	Binary Offset
10	Satellite ID	In binary logs, the satellite ID field is 4 bytes. The 2 lowest order bytes, interpreted as a USHORT, are the system identifier. For instance, the PRN for GPS or the slot for GLONASS. The 2 highest-order bytes are the frequency channel for GLONASS, interpreted as a SHORT and zero for all other systems. In ASCII and abbreviated ASCII logs, the satellite ID field is the system identifier. If the system is GLONASS and the frequency channel is not zero, then the signed channel is appended to the system identifier. For example, slot 13, frequency channel -2 is output as 13-2.	Ulong	4	H+40
11	Next offset field = H+36+(#SVs * 8)				
12	xxxx	32-bit CRC (ASCII and Binary only)	Ulong	4	H+36 + (#SVs * 8)
13	[CR][LF]	Sentence terminator (ASCII only)			

Table 118: RAIM Mode Types

Binary	ASCII	Description
0	DISABLE	Do not do integrity monitoring of least squares solution
1	USER	User will specify alert limits and probability of false alert
2	DEFAULT	Use NovAtel RAIM (default)
3	APPROACH	Default numbers for non-precision approach navigation modes are used - HAL = 556 m (0.3 nm), VAL = 50 m for LNAV/VNAV
4	TERMINAL	Default numbers for terminal navigation mode are used - HAL = 1855 m (1 nm), no VAL requirement
5	ENROUTE	Default numbers for enroute navigation mode are used - HAL = 3710 m (2 nm), no VAL requirement

Table 119: Integrity Status

Binary	ASCII	Description
0	NOT_AVAILABLE	RAIM is unavailable because either there is no solution or because the solution is unique, that is, there is no redundancy

Binary	ASCII	Description
1	PASS	RAIM succeeded. Either there were no bad observations or the bad observations were successfully removed from the solution
2	FAIL	RAIM detected a failure and was unable to isolate the bad observations

Table 120: Protection Level Status

Binary	ASCII	Description
0	NOT_AVAILABLE	When RAIM is not available. For example, immediately after issuing a FRESET command (see page 127) or when there are not enough satellites tracked to have the required redundant observations.
1	PASS	Current protection levels are below alert limits, meaning positioning accuracy requirements are fulfilled. HPL < HAL VPL < VAL
2	ALERT	Current protection levels are above alert limits, meaning required positioning accuracy cannot be guaranteed by RAIM algorithm. HPL ≥ HAL VPL ≥ VAL

3.125 RANGE

Satellite range information

Platform: OEM719, OEM729, OEM7500, OEM7600, OEM7700, OEM7720, PwrPak7, SPAN CPT7, SMART7, SMART2

The RANGE log contains the channel measurements for the currently tracked satellites. When using this log, please keep in mind the constraints noted along with the description.

It is important to ensure that the receiver clock has been set. This can be monitored by the bits in the Receiver Status field of the log header. Large jumps in pseudorange as well as Accumulated Doppler Range (ADR) occur as the clock is being adjusted. If the ADR measurement is being used in precise phase processing, it is important not to use the ADR if the "parity known" flag, in the ch-tr-status field, is not set as there may exist a half (1/2) cycle ambiguity on the measurement. The tracking error estimate of the pseudorange and carrier phase (ADR) is the thermal noise of the receiver tracking loops only. It does not account for possible multipath errors or atmospheric delays.

If multiple signals are being tracked for a given PRN, an entry for each signal, with the same PRN, appears in the RANGE logs. As shown in *Table 121: Channel Tracking Status* on page 614, these entries can be differentiated by bits 21-25, which indicate the signal type of the observation.



For dual antenna receivers, a RANGE_1 log can be requested to get RANGE data from the second antenna. As described in *Table 3: Binary Message Header Structure* on page 31, the message type indicates the log is from the second antenna. To request an ASCII log enter RANGEA_1, and for a binary log enter RANGEB_1.

Message ID: 43

Log Type: Synch

Recommended Input:

```
log rangea ontime 30
```

Abbreviated ASCII Example:

```
<RANGE COM1 0 82.0 FINESTEERING 1729 155076.000 02004000 5103 11465
46
31 0 24514687.250 0.064 -128825561.494675 0.010 3877.473 45.0 563.310 18109c04
31 0 24514688.765 0.096 -100383546.734328 0.010 3021.415 39.8 558.900 02309c0b
14 0 20345286.178 0.047 -106915249.491005 0.008 90.799 47.6 10283.130 08109c24
14 0 20345282.367 0.130 -83310588.842026 0.008 70.753 44.0 10276.900 01303c2b
22 0 20789170.556 0.038 -109247823.573628 0.007 -1421.169 49.4 15829.450
18109c44
22 0 20789164.279 0.138 -85128150.759123 0.007 -1107.404 43.6 15822.400
11303c4b
11 0 21977065.699 0.057 -115490261.964920 0.009 1235.428 46.0 5831.400 18109c64
11 0 21977062.220 0.201 -89992401.903056 0.011 962.671 40.3 5823.900 11303c6b
1 0 23109644.678 0.073 -121441999.794897 0.011 2971.250 43.8 3239.620 18109ca4
1 0 23109646.769 0.073 -94630142.467139 0.011 2315.261 42.1 3233.420 02309cab
1 0 23109647.385 0.009 -90687226.778371 0.009 2218.538 48.9 3237.080 01d03ca4
32 0 23839782.353 0.133 -125278916.608912 0.022 3033.561 38.7 2193.280 18109cc4
```

```
32 0 23839781.295 0.363 -97619939.025504 0.026 2363.815 35.1 2184.900 11303ccb
18 0 22923322.792 0.062 -120462840.747702 0.009 -2710.945 45.3 20493.260
18109d04
18 0 22923320.071 0.350 -93867119.471860 0.012 -2112.426 35.5 20484.400
11303d0b
24 0 23708761.188 0.111 -124590391.778428 0.015 -2376.459 40.2 10643.820
08109d24
24 0 23708763.572 0.065 -97083440.180816 0.015 -1851.788 43.1 10639.420
02309d2b
24 0 23708765.724 0.009 -93038305.697497 0.008 -1774.807 49.1 10641.680
01d03d24
19 0 23739234.067 0.078 -124750470.392697 0.013 -2778.561 43.3 12263.180
08109d64
19 0 23739230.131 0.250 -97208136.646475 0.014 -2165.115 38.4 12255.400
01303d6b
61 9 22189063.544 0.155 -118654856.801346 0.011 -3985.235 43.3 13310.882
08119e04
61 9 22189063.246 0.055 -92287085.024614 0.011 -3099.631 37.6 13303.964
00b13e0b
47 0 21209673.567 0.147 -113059527.680842 0.011 -804.710 43.8 7342.680 08119e24
47 0 21209679.575 0.043 -87935228.320976 0.011 -625.886 39.7 7334.968 00b13e2b
46 5 24097664.754 0.213 -128680178.570435 0.014 -3740.543 40.6 10098.600
08119e44
46 5 24097669.137 0.048 -100084595.729257 0.015 -2909.311 38.8 10082.838
10b13e4b
39 3 21484445.079 0.161 -114645140.076744 0.012 2864.162 43.0 4463.150 18119e64
39 3 21484447.532 0.046 -89168467.325722 0.013 2227.683 39.1 4453.468 10b13e6b
38 8 19445896.471 0.101 -103949483.524466 0.008 -389.973 47.1 11640.260
18119e84
38 8 19445897.101 0.048 -80849619.556577 0.009 -303.312 38.8 11632.974 00b13e8b
48 7 21301665.694 0.166 -113829687.684616 0.011 3143.656 42.8 3778.910 08119ea4
48 7 21301667.294 0.054 -88534230.502244 0.012 2445.068 37.8 3770.968 10b13eab
54 11 20899591.029 0.131 -111837944.708346 0.009 -401.734 44.8 7155.190
18119ec4
54 11 20899589.241 0.024 -86985062.942139 0.009 -312.461 44.8 7146.970 10b13ecb
55 4 23127316.661 0.318 -123455195.443877 0.020 3067.787 37.1 1588.420 18119ee4
55 4 23127321.850 0.032 -96020732.562183 0.021 2386.060 42.3 1580.442 00b13eeb
12 0 26239080.161 0.048 -137887256.553732 0.015 -2696.802 47.6 11527.710
48539c24
12 0 26239085.285 0.012 -102967750.707625 0.013 -2013.883 46.8 11523.770
41933c24
12 0 26239083.219 0.011 -105653860.401460 0.013 -2066.457 47.3 11523.712
42333c24
12 0 26239094.196 0.019 -104310841.607718 0.014 -2040.204 42.7 11522.970
42933c24
11 0 25589806.061 0.045 -134475330.397885 0.013 -729.686 48.0 4974.653 48539c64
11 0 25589809.285 0.010 -100419891.315177 0.012 -545.179 47.8 4969.770 41933c64
11 0 25589806.124 0.010 -103039536.069621 0.011 -559.405 48.0 4969.734 42333c64
11 0 25589818.004 0.017 -101729751.744395 0.013 -552.305 43.7 4967.060 42933c64
8 0 39844800.850 0.077 -207482308.002186 0.018 -507.335 37.4 12048.980 18149c84
8 0 39844800.076 0.043 -160438471.200694 0.013 -392.547 42.5 12038.660 00349c84
```

Field	Field type	Description	Format	Binary Bytes	Binary Offset
1	RANGE header	Log header. See <i>Messages</i> on page 27 for more information.		H	0
2	# obs	Number of observations with information to follow ¹	Ulong	4	H
3	PRN/slot	Satellite PRN number of range measurement Refer to <i>PRN Numbers</i> on page 46	Ushort	2	H+4
4	glofreq	(GLONASS Frequency + 7) (see GLONASS Slot and Frequency Numbers section of this manual)	Ushort	2	H+6
5	psr	Pseudorange measurement (m)	Double	8	H+8
6	psr σ	Pseudorange measurement standard deviation (m)	Float	4	H+16
7	adr	Carrier phase, in cycles (accumulated Doppler range)	Double	8	H+20
8	adr σ	Estimated carrier phase standard deviation (cycles)	Float	4	H+28
9	dopp	Instantaneous carrier Doppler frequency (Hz)	Float	4	H+32
10	C/No	Carrier to noise density ratio $C/No = 10[\log_{10}(S/N_0)]$ (dB-Hz)	Float	4	H+36
11	locktime	Number of seconds of continuous tracking (no cycle slipping)	Float	4	H+40
12	ch-tr-status	Tracking status (see <i>Table 121: Channel Tracking Status</i> on the next page and the example in <i>Figure 8: Channel Tracking Example</i> on the next page)	Ulong	4	H+44
13...	Next PRN offset = $H + 4 + (\#obs \times 44)$				
variable	xxxx	32-bit CRC (ASCII and Binary only)	Ulong	4	H+4+ (#obs x 44)
variable	[CR][LF]	Sentence terminator (ASCII only)	-	-	-

¹Satellite PRNs may have multiple lines of observations, one for each signal tracked.

Figure 8: Channel Tracking Example

		N7				N6				N5				N4				N3				N2				N1				N0																	
0x		0				8				1				0				9				C				0				4																	
Bit		31	30	29	28	27	26	25	24	23	22	21	20	19	18	17	16	15	14	13	12	11	10	9	8	7	6	5	4	3	2	1	0														
Binary		0	0	0	0	1	0	0	0	0	0	0	1	0	0	0	0	1	0	0	1	1	1	1	0	0	0	0	0	0	0	1	0														
Data		Channel Assignment Lock Flag		Digital filtering on signal Phase Measurement		Primary L1		Signal Type				Grouping				Reserved				Satellite System				Correlator Spacing				Code Locked Flag				Parity Flag				Phase Lock Flag				Channel Number				Tracking State			
Value		Automatic Lock Out		No Digital Filter Half Cycle		Primary		L1 C/A				Grouped				Reserved				GPS				PAC				Locked				Known				Locked				Channel 0				L1 Phase Lock Loop			

Table 121: Channel Tracking Status

Nibble	Bit	Mask	Description	Range Value
N0	0	0x00000001	Tracking state	0-23, see <i>Table 122: Tracking State</i> on page 616
	1	0x00000002		
	2	0x00000004		
	3	0x00000008		
N1	4	0x00000010	SV channel number	(n-1) (0 = first, n = last) n depends on the receiver
	5	0x00000020		
	6	0x00000040		
N2	7	0x00000080	Phase lock flag	0 = Not locked, 1 = Locked
	8	0x00000100		
	9	0x00000200		
	10	0x00000400		
	11	0x00000800	Parity known flag	0 = Not known, 1 = Known

Nibble	Bit	Mask	Description	Range Value	
N3	12	0x00001000	Code locked flag	0 = Not locked, 1 = Locked	
	13	0x00002000	Correlator type	0-7, see <i>Table 123: Correlator Type</i> on the next page	
	14	0x00004000			
	15	0x00008000			
N4	16	0x00010000	Satellite system	0 = GPS	4 = BeiDou
	17	0x00020000		1 = GLONASS	5 = QZSS
	18	0x00040000		2 = SBAS	6 = NavIC
	19	0x00080000	3 = Galileo	7 = Other	
N5	20	0x00100000	Grouping	0 = Not grouped, 1 = Grouped	
	21	0x00200000	Signal type (Dependent on satellite system above)	<u>GPS:</u> 0 = L1C/A 5 = L2P 9 = L2P (Y), semi-codeless 14 = L5 (Q) 16 = L1C (P) 17 = L2C (M) <u>GLONASS:</u> 0 = L1C/A 1 = L2C/A 5 = L2P 6 = L3 (Q) <u>BeiDou:</u> 0 = B1 (I) with D1 data 1 = B2 (I) with D1 data 2 = B3 (I) with D1 data 4 = B1 (I) with D2 data 5 = B2 (I) with D2 data 6 = B3 (I) with D2 data 7 = B1C (P) 9 = B2a (P) <u>Galileo:</u> 2 = E1 (C) 6 = E6B 7 = E6C 12 = E5a (Q) 17 = E5b (Q) 20 = E5AltBOC (Q) <u>QZSS:</u> 0 = L1C/A 14 = L5 (Q) 16 = L1C (P) 17 = L2C (M) 27 = L6P <u>SBAS:</u> 0 = L1C/A 6 = L5 (I) <u>NavIC:</u> 0 = L5 SPS <u>Other:</u> 19 = L-Band	
	22	0x00400000			
	23	0x00800000			
N6	24	0x01000000	Signal type (Dependent on satellite system above)	<u>GPS:</u> 0 = L1C/A 5 = L2P 9 = L2P (Y), semi-codeless 14 = L5 (Q) 16 = L1C (P) 17 = L2C (M) <u>GLONASS:</u> 0 = L1C/A 1 = L2C/A 5 = L2P 6 = L3 (Q) <u>BeiDou:</u> 0 = B1 (I) with D1 data 1 = B2 (I) with D1 data 2 = B3 (I) with D1 data 4 = B1 (I) with D2 data 5 = B2 (I) with D2 data 6 = B3 (I) with D2 data 7 = B1C (P) 9 = B2a (P) <u>Galileo:</u> 2 = E1 (C) 6 = E6B 7 = E6C 12 = E5a (Q) 17 = E5b (Q) 20 = E5AltBOC (Q) <u>QZSS:</u> 0 = L1C/A 14 = L5 (Q) 16 = L1C (P) 17 = L2C (M) 27 = L6P <u>SBAS:</u> 0 = L1C/A 6 = L5 (I) <u>NavIC:</u> 0 = L5 SPS <u>Other:</u> 19 = L-Band	
	25	0x02000000			
	26	0x04000000			Reserved
	27	0x08000000	Primary L1 channel	0 = Not primary, 1 = Primary	

Nibble	Bit	Mask	Description	Range Value
N7	28	0x10000000	Carrier phase measurement ¹	0 = Half Cycle Not Added 1 = Half Cycle Added
	29	0x20000000	Digital filtering on signal	0 = No digital filter 1 = Digital filter
	30	0x40000000	PRN lock flag ²	0 = PRN Not Locked Out 1 = PRN Locked Out
	31	0x80000000	Channel assignment	0 = Automatic, 1 = Forced

Table 122: Tracking State

State	Description
0	Idle
1	Sky Search
2	Wide frequency band pull-in
3	Narrow frequency band pull-in
4	Phase lock loop
6	Channel steering
7	Frequency lock loop
9	Channel alignment
10	Code search
11	Aided phase lock loop
23	Side peak detection

Table 123: Correlator Type

State	Description
0	N/A
1	Standard correlator: spacing = 1 chip

¹This bit is zero until the parity is known and the parity known flag (bit 11) is set to 1.

After a loss of lock, there is a half cycle ambiguity on the ADR (carrier phase) until enough navigation data has been decoded to determine the correct phase of the carrier. At the point this is determined, the "parity known" and "half cycle added" flags will get set. If the half cycle flag is set to 1, it indicates that a half cycle was added to the ADR to correct an inverted phase.

²A PRN can be locked out using the **LOCKOUT** command.

State	Description
2	Narrow Correlator: spacing < 1 chip
3	Reserved
4	Pulse Aperture Correlator (PAC)
5	Narrow PAC
6	Reserved

Table 124: RINEX Mappings

GNSS System	Frequency Band	Frequency	Observation Codes				
			Signal Type	Pseudo Range	Carrier Phase	Doppler	Signal Strength
GPS	L1	1575.42	L1CA	C1C	L1C	D1C	S1C
			L1C(P)	C1L	L1L	D1L	S1L
	L2	1227.6	L2C(M)	C2S	L2S	D2S	S2S
			L2P	L2P	C2P	D2P	S2P
			L2P(Y)	C2W	L2W	D2W	S2W
L5	1176.45	L5(Q)	C5Q	L5Q	D5Q	S5Q	
GLONASS	G1	1598.0625-1609.3125	L1CA	C1C	L1C	D1C	S1C
	G2	1242.9375-1251.6875	L2CA	C2C	L2C	D2C	S2C
			L2P	C2P	L2P	D2P	S2P
G3	1202.025	L3(Q)	C3Q	L3Q	D3Q	S3Q	
Galileo	E1	1575.42	E1C	C1C	L1C	D1C	S1C
	E5a	1176.45	E5a(Q)	C5Q	L5Q	D5Q	S5Q
	E5b	1207.14	E5b(Q)	C7Q	L7Q	D7Q	S7Q
	E5 (E5a+E5b)	1191.795	E5AltBOC (Q)	C8Q	L8Q	D8Q	S8Q
	E6	1278.75	E6C	C6C	L6C	D6C	S6C
SBAS	L1	1575.42	L1CA	C1C	L1C	D1C	S1C
	L5	1176.45	L5(I)	C5I	L5I	D5I	S5I

GNSS System	Frequency Band	Frequency	Observation Codes				
			Signal Type	Pseudo Range	Carrier Phase	Doppler	Signal Strength
QZSS	L1	1575.42	L1CA	C1C	L1C	D1C	S1C
			L1C(P)	C1L	L1L	D1L	S1L
	L2	1227.6	L2C(M)	C2S	L2S	D2S	S2S
	L5	1176.45	L5(Q)	C5Q	L5Q	D5Q	S5Q
	L6	1278.75	L6(P)	C6L	L6L	D6L	S6L
BeiDou	B1	1561.098	B1(I)	C2I	L2I	D2I	S2I
	B1C	1575.42	B1C(P)	C1P	L1P	D1P	S1P
	B2	1207.14	B2(I)	C7I	L7I	D7I	S7I
	B2a	1176.45	B2a(P)	C5P	L5P	D5P	S5P
	B3	1268.52	B3(I)	C6I	L6I	D6I	S6I
NavIC	L5	1176.45	L5SPS	C5A	L5A	D5A	S5A

3.126 RANGECMP

Compressed version of the RANGE log

Platform: OEM719, OEM729, OEM7500, OEM7600, OEM7700, OEM7720, PwrPak7, SPAN CPT7, SMART7, SMART2

This log contains the RANGE data in a compressed format.



For dual antenna receivers, a RANGECMP_1 log can be requested to get RANGECMP data from the second antenna. As described in *Table 3: Binary Message Header Structure* on page 31, the message type indicates the log is from the second antenna. To request an ASCII log enter RANGECMPA_1, and for a binary log enter RANGECMPB_1.

Message ID: 140

Log Type: Synch

Recommended Input:

```
log rangecmpa ontime 10
```

ASCII Example:

```
#RANGECMPA,COM1,0,63.5,FINESTEERING, 1429,226780.000,02000000,9691,2748;
26,
049c10081857f2df1f4a130ba2888eb9600603a709030000,
0b9c3001225bf58f334a130bb1e2bed473062fa609020000,
449c1008340400e0aaa9a109a7535bac2015cf71c6030000,
4b9c300145030010a6a9a10959c2f09120151f7166030000,
...
0b9d301113c8ffefc284000c6ea051dbf3089da1a0010000,
249d1018c6b7f67fa228820af2e5e39830180ae1a8030000,
2b9d301165c4f8fffb228820a500a089f31185fe0a8020000,
449d1018be18f41f2aacad0a1a934efc40074ecf88030000,
4b9d301182b9f69f38acad0a3e3ac28841079fcb88020000,
849d101817a1f95f16d7af0a69fbel1fa401d3fd064030000,
8b9d30112909fb2f20d7af0a9f24a687521ddece64020000,
249e1118af4e0470f66d4309a0a631cd642cf5b821320000,
2b9eb110a55903502f6e4309ee28d1ad032c7cb7e1320000,
849e1118b878f54f4ed2aa098c35558a532bde1765220000,
8b9eb110abcff71f5ed2aa09cb6ad0f9032b9d16c5220000*0eeead18
```

Field	Field Type	Description	Format	Binary Bytes	Binary Offset
1	RANGECMP header	Log header. See <i>Messages</i> on page 27 for more information.		H	0
2	#obs	Number of satellite observations with information to follow	Ulong	4	H

Field	Field Type	Description	Format	Binary Bytes	Binary Offset
3	1st range record	Compressed range log in format of <i>Table 125: Range Record Format (RANGECMP only)</i> below	Hex	24	H+4
4	Next rangecmp offset = H+4 (#obs x 24)				
5	xxxx	32-bit CRC (ASCII and Binary only)	Ulong	4	H+4+ (#obs x 24)
6	[CR][LF]	Sentence terminator (ASCII only)	-	-	-

Table 125: Range Record Format (RANGECMP only)

Data	Description	Bits first to last	Length (bits)	Scale Factor	Units
Channel Tracking Status	Channel tracking status word	0-31	32	see <i>Table 121: Channel Tracking Status</i> on page 614	-
Doppler Frequency	Instantaneous carrier Doppler frequency	32-59	28	1/256	Hz
Pseudorange (PSR)	Pseudorange measurement	60-95	36	1/128	m

Data	Description	Bits first to last	Length (bits)	Scale Factor	Units
ADR	<p>ADR (Accumulated Doppler Range) is calculated as follows:</p> $\text{ADR_ROLLS} = (\text{RANGECMP_PSR} / \text{WAVELENGTH} + \text{RANGECMP_ADR}) / \text{MAX_VALUE}$ <p>Round to the closest integer</p> <p>IF (ADR_ROLLS ≤ 0) ADR_ROLLS = ADR_ROLLS - 0.5 ELSE ADR_ROLLS = ADR_ROLLS + 0.5</p> <p>At this point integerise ADR_ROLLS CORRECTED_ADR = RANGECMP_ADR - (MAX_VALUE*ADR_ROLLS) where ADR has units of cycles WAVELENGTH = 0.1902936727984 for GPS L1 WAVELENGTH = 0.2442102134246 for GPS L2 MAX_VALUE = 8388608</p> <p>Note: GLONASS satellites emit L1 and L2 carrier waves at a satellite-specific frequency, refer to the GLONASS section of An Introduction to GNSS available on our website</p>	96-127	32	1/256	cycles
StdDev-PSR	Pseudorange measurement standard deviation	128-131	4	See Table 126: StdDev-PSR Values on the next page	m
StdDev-ADR	ADR measurement standard deviation	132-135	4	(n+1)/512	cycles
PRN/Slot	Refer to <i>PRN Numbers</i> on page 46	136-143	8	1	-
Lock Time	<p>Number of seconds of continuous tracking (no cycle slipping)</p> <p>This field is constrained to a maximum value of 2,097,151 which represents a lock time of 65535.96875 s (2097151/32).</p>	144-164	21	1/32	s

Data	Description	Bits first to last	Length (bits)	Scale Factor	Units
C/No	Carrier to noise density ratio The C/No is constrained to a value between 20-51 dB-Hz. Thus, if it is reported that C/No = 20 dB-Hz, the actual value could be less. Likewise, if it is reported that C/No = 51, the true value could be greater.	165-169	5	(20+n)	dB-Hz
GLONASS Frequency number	GLONASS Frequency number	170-175	n+7	1	
Reserved		176-191	16		

Table 126: StdDev-PSR Values

Code	StdDev-PSR (m)
0	0.050
1	0.075
2	0.113
3	0.169
4	0.253
5	0.380
6	0.570
7	0.854
8	1.281
9	2.375
10	4.750
11	9.500
12	19.000
13	38.000
14	76.000
15	152.000

3.127 RANGECMP2

Compressed version of the RANGE log

Platform: OEM719, OEM729, OEM7500, OEM7600, OEM7700, OEM7720, PwrPak7, SPAN CPT7, SMART7, SMART2

This log contains the RANGE data in a compressed format to handle more channels and different channel types than the RANGECMP log.



For dual antenna receivers, a RANGECMP2_1 log can be requested to get RANGECMP2 data from the second antenna. As described in *Table 3: Binary Message Header Structure* on page 31, the message type indicates the log is from the second antenna. To request an ASCII log enter RANGECMP2A_1, and for a binary log enter RANGECMP2B_1.

Message ID: 1273

Log Type: Synch

Recommended Input:

```
log rangecmp2a ontime 10
```

Example:

```
#RANGECMP2A,COM1,0,84.5,FINESTEERING,1681,163457.000,02000020,1fe3,10526;634,
000d00f4fddf05920620e1ffff2979e806e81301c8ffe4ffff03106b5a50a902c8ff01100054f6b
d05410720e1ffff2996ea0e90fb01e2ffe4ffff030e0d65681603e3ff020400acdc605c40320e1
ffff697b080e9859801300e4ffff4310c94fb8c70114000317002c554685260520e1ffff295f441
2b0ad03c4ffe4ffff03d5a60d18c705c4ff0401008452b08583f92fe1ffff2998ac65302c800000
e4ffff03f32edf784b0000000520000c8500056cfd2fe1ffff295fa40dd04a822300e4ffff03b82
42a58f8022300061f00c0081385effb2fe1ffff295fc408a83884f8ffe4ffff03b8861608c286f8
ff081e008cb25105970520e1ffff295c2604989483ceffe4ffff03f2862f489006cfff091400302
7e204930020e1ffff695e4407188602ddffe4ffff43b8241480c903ddff0a0e0050e3e305d3f92f
e1ffff2979c89c506d800700e4ffff030f4bdd603a8006000b1900d8f3cc8543fb2fe1ffff297a2
80950f2002500e4ffff03f1286880e8022500140118341c0f0581f92fe1ffff299d4404d02401f2
ffe4ffff03920c2f900d82faff160d158cfa6b85400820e1ffff69baa600b83d02d9ffe4ffff037
34a4380ea04ceff170b178874ef0409fa2fe1ffff299d6409d01904e6ffe4ffff0374ea31304d87
daff180213c8039884fd0020e1ffff697fe401007082d4ffe4ffff033b0616688084c4ff19131a5
cdc9585f9fe2fe1ffff69b8c80e08e5800200e4ffff0357c830a8d001ebff1b0c16a45ca384c802
20e1ffff697f6401888a04efffe4ffff033a463d605e8802001c031c905434051d0720e1ffff299
cc60b18e881f3ffe4ffff0339462d38e182fbff231050f05e6406b9fd1fe6ffff6998080f101380
1300*61b80516
```

Field	Field Type	Description	Format	Binary Bytes	Binary Offset
1	RANGECMP2 header	Log header. See <i>Messages</i> on page 27 for more information.		H	0

Field	Field Type	Description	Format	Binary Bytes	Binary Offset
2	# bytes	Number of bytes in the compressed binary range data ¹	Uchar	4	H
3	RangeData	Compressed binary range data in the format of <i>Table 127: Satellite Block of the Range Record Format (RANGECMP2 only)</i> below and <i>Table 128: Signal Block of the Range Record Format (RANGECMP2 only)</i> on the next page ²	Uchar	#bytes	H+4
4	xxxx	32-bit CRC (ASCII and binary only)	Hex	4	H+4+ (# bytes)
5	[CR][LF]	Sentence terminator (ASCII only)	-	-	-

Table 127: Satellite Block of the Range Record Format (RANGECMP2 only)

Data	Description	Bits first to last	Length (bits)	Scale Factor	Units
SV Channel Number	Receiver SV channel number	0-7	8	-	-
Satellite Identifier	Satellite identifier specific to the satellite system Refer to <i>PRN Numbers</i> on page 46	8-15	8	-	-
GLONASS Frequency Identifier	GLONASS frequency channel offset by +7	16-19	4	(7+Ch#)	-
Satellite System Identifier	Defined in <i>Table 93: Satellite System</i> on page 477	20-24	5	-	Enum
Reserved		25	1	-	-
Pseudorange Base	Pseudorange base value to be combined with PSR Diff and Phaserange Diff in each following Signal Block	26-54	29	1	m

¹Maximum is 2880 bytes for 120 channels; maximum 5760 for 240 channels.

²The compressed binary range data is organized into satellite blocks, one for each satellite. Each satellite block is followed by a variable number of signal blocks corresponding to the same satellite. For example, a Satellite Block for GPS PRN 17 may be followed by two Signal Blocks for the L1 C/A and L2C signals.

Data	Description	Bits first to last	Length (bits)	Scale Factor	Units
Doppler Base	Doppler base value to be combined with the Scaled Doppler Diff value in each following Signal Block	55-75	21	1	Hz
Number of Signal Blocks	The number of Signal Blocks to follow this Satellite Block. See <i>Table 128: Signal Block of the Range Record Format (RANGECMP2 only)</i> below for Signal Block definition	76-79	4	-	-

Table 128: Signal Block of the Range Record Format (RANGECMP2 only)

Data	Description	Bits first to last	Length (bits)	Scale Factor	Units
Signal Type	Defined in <i>Table 132: Signal Type (only in RANGECMP2)</i> on page 629	0-4	5	-	Enum
Phase Lock	Phase Lock: 0 = Not locked, 1 = Locked	5	1	-	Bool
Parity Known	Parity Known: 0 = Not known, 1 = Known	6	1	-	Bool
Code Lock	Code Lock: 0 = Not locked, 1 = Locked	7	1	-	Bool
Locktime	Time of continuous tracking with no cycle slips. The locktime value saturates at a maximum of 131071 ms	8-24	17	1	ms
Correlator Type	Correlator type: (see <i>Table 123: Correlator Type</i> on page 616)	25-28	4	-	Enum
Primary Signal	Primary signal: 0 = Not primary, 1 = Primary	29	1	-	Bool
Carrier Phase Measurement	Carrier phase measurement: 0 = Half cycle not added, 1 = Half cycle added	30	1	-	Bool
Reserved		31	1	-	-
C/No	Carrier to Noise density ratio	32-36	5	(20 + n)	dB-Hz

Data	Description	Bits first to last	Length (bits)	Scale Factor	Units
StdDev PSR	Pseudorange Standard Deviation (defined <i>Table 129: Std Dev PSR Scaling</i> below)	37-40	4	Bit Field in <i>Table 129: Std Dev PSR Scaling</i> below	-
StdDev ADR	Carrier-Phase Standard Deviation (defined <i>Table 130: Std Dev ADR Scaling</i> on the next page)	41-44	4	Bit Field in <i>Table 130: Std Dev ADR Scaling</i> on the next page	-
PSR Diff	Pseudorange Diff to be combined with Pseudorange base i.e., $PSR = PSRBase + PSRDiff/128$	45-58	14	1/128	m (unsigned)
Phaserange Diff	Phaserange Diff to be combined with Pseudorange Base i.e., $ADR = PSRBase + PhaserangeDiff/2048$	59-78	20	1/2048	m (unsigned)
Scaled Doppler Diff ¹	Doppler Diff to be combined with Doppler Base. Note that all Doppler values are scaled to the L1/E1 equivalent value. (refer to <i>Table 131: L1/E1/B1 Scaling</i> on page 628) i.e., $Doppler = (DopplerBase + ScaledDopplerDiff/256)/L1ScaleFactor$	79-95	17	1/256	Hz (signed)

Table 129: Std Dev PSR Scaling

PSR Std Dev Bit Field Value	Represented Std Dev (m)
0	0.02
1	0.03
2	0.045
3	0.066

¹The Scaled Doppler Diff field is the only field in the RANGECP2 that should be parsed as Two's Complement. The most significant byte (MSB) determines whether the number will be positive (< 0x7) or negative (> 0x7). Two's complement should be applied prior to AND, right bit shift computations.

PSR Std Dev Bit Field Value	Represented Std Dev (m)
4	0.099
5	0.148
6	0.22
7	0.329
8	0.491
9	0.732
10	1.092
11	1.629
12	2.43
13	3.625
14	5.409
15	>5.409

Table 130: Std Dev ADR Scaling

ADR Std Dev Bit Field Value	Represented Std Dev (cycles)
0	0.00391
1	0.00521
2	0.00696
3	0.00929
4	0.01239
5	0.01654
6	0.02208
7	0.02947
8	0.03933
9	0.05249
10	0.07006
11	0.09350
12	0.12480
13	0.16656
14	0.22230
15	>0.22230

Table 131: L1/E1/B1 Scaling

Satellite System	Signal Type	L1/E1/B1 Scale Factor
GPS	L1CA	1.0
	L2Y	154/120
	L2C	154/120
	L5Q	154/115
GLONASS	L1CA	1.0
	L2CA	9/7
	L2P	9/7
SBAS	L1CA	1.0
	L5I	154/115
Galileo	E1	1.0
	E5A	154/115
	E5B	154/118
	AltBOC	154/116.5
	E6C	154/125
	E6B	154/125
QZSS	L1CA	1.0
	L2C	154/120
	L5Q	154/115
	L6P	154/125
LBAND	LBAND	1.0
BDS	B1	1.0
	B1C	1526/1540
	B2	1526/1180
	B2a	1526/1150
	B3	1526/1240
NAVIC	L5SPS	1.0

Table 132: Signal Type (only in RANGECMP2)

Satellite System	Signal Type	Value
GPS	L1CA	1
	L2Y	4
	L2CM	5
	L5Q	7
	L1C	15
GLONASS	L1CA	1
	L2CA	3
	L2P	4
	L3Q	6
SBAS	L1CA	1
	L5I	2
Galileo	E1C	1
	E5AQ	2
	E5BQ	3
	AltBOCQ	4
	E6C	5
	E6B	12
QZSS	L1CA	1
	L2CM	3
	L5Q	4
	L1C	8
	L6P	11
LBAND	LBAND	1

Satellite System	Signal Type	Value
BDS	B1D1I	1
	B1D2I	2
	B2D1I	3
	B2D2I	4
	B3D1I	13
	B3D2I	14
	B1CP	19
	B2AP	20
NAVIC	L5SPS	1

3.128 RANGECMP4

Highly compressed version of the RANGE log

Platform: OEM719, OEM729, OEM7500, OEM7600, OEM7700, OEM7720, PwrPak7, SPAN CPT7, SMART7, SMART2

This log contains the RANGE data in a more heavily compressed format compared to the RANGECMP2 log.



For dual antenna receivers, a RANGECMP4_1 log can be requested to get RANGECMP4 data from the second antenna. As described in *Table 3: Binary Message Header Structure* on page 31, the message type indicates the log is from the second antenna. To request an ASCII log enter RANGECMP4A_1, and for a binary log enter RANGECMP4B_1.



1. Channels that have been manually assigned to a PRN with **ASSIGN** or **ASSIGNALL** are not reported in the **RANGECMP4** log.
2. L-Band channels are not reported in the **RANGECMP4** log.
3. **RANGECMP4** is a complex log. For more information about decoding the **RANGECMP4** log, refer to *Example of Bit Parsing a RANGECMP4 Log* on page 958.

Message ID: 2050

Log Type: Synch

Recommended Input:

```
log rangecmp4a ontime 10
```

Example:

```
#RANGECMP4A,COM1,0,81.5,FINESTEERING,1921,228459.000,00000020,fb0e,32768;627,
630032090851000000009200dbbf7d8306f822d0a3b2bc897f0010d350428cf31228ea9f7300040
050ff5e641cb7c7463d2a00b6a4644f6e5ee2a0fe530a00fe1f829dcfe4cf30d52abaf37f94e016
21cd8d8c04a0bafcaf00e43b0761690064e7bfe90f11ce8710a4eb2b573202607403fc28e647c6f
e9f550118007a9d839c2680ebfedff6876be81150411adbc972feef4686c483f30a09f01773ff0b
0050d8b8a843f41576b94100440e1e4f59ace54fffca2700fc1f62e14720f4facba64affbf9c52f
f39ce4b3eef9f14fd0f00244387d00d80fefabfeb0fb3cf456ae97542d410fc9ffab7f601e73580
e5efdaff0f00a0b33991fc072ccbbaa99ff134efa9fd0dc684bfc61f0fffefff60b02000000000800
4c0ff3fa0b2f724f7e1eee889e9fb9f3977c0437391ab135877fe0b00301edf93f4bd63c62850fd
bf8527e6e5cd438e3a208400e0ff43bb6f5fc2101c75b058daff375c5ea4378f51940022eeffff0
fe1c97dcda81887c83a63007c9d5a7ed65ce6f901427bffff3f9c04f735db1d55294a3bfc5f35cc
c66df318c412181400140060eedbd7285feaf6a653f9bf9fc7fe27cd653633c0b5fcffff03197b4
f8228d4e59d0cfbffa731b2f73b07e9b68078f47f0000a9be7dcdcc51898da269fe839b6191ab9c
c67701f21000fc3f0001a1000000008002c03fb4362793b9bfeb657dfcf6badabb9a4375b77f5
bff1fed87bce64454a98ae16c14ff4fec6f7a48f3206b03e8040138fbd0023d225492cd7679a4ff
a5623b08810e42bf05fce17fa41f9a9ccfc8e2626231edf2ff208a1225ce6150204067febfe030
10000000000028000ca9cc8728bb3306e68af97f921cfce3e632f0d1cf8300c8f701*6de99eb7
```

Field	Field Type	Description	Format	Binary Bytes	Binary Offset
1	RANGECMP4 header	Log header. See <i>Messages</i> on page 27 for more information.	-	H	0
2	# bytes	Number of bytes in the compressed binary Range Data.	Uchar	4	H
3	Range Data	<p>The compressed binary range data is organized into satellite system blocks which break down into measurement blocks for each active signal within each system. Refer to the following tables for more details about this format:</p> <p><i>Table 133: Header</i> on the next page (sent once)</p> <p><i>Table 134: Satellite and Signal Block</i> on the next page (sent once per satellite system bit set to 1 in the GNSS Field found in <i>Table 133: Header</i> on the next page)</p> <p><i>Table 135: Measurement Block Header</i> on page 634 (sent once for each bit set to 1 in the Satellites Field found in <i>Table 134: Satellite and Signal Block</i> on the next page)</p> <p><i>Table 136: Primary Reference Signal Measurement Block</i> on page 635 and <i>Table 137: Secondary Reference Signals Measurement Block</i> on page 636, or <i>Table 138: Primary Differential Signal Measurement Block</i> on page 637 and <i>Table 139: Secondary Differential Signals Measurement Block</i> on page 639, Measurement Block (sent for each bit set to 1 in the Included Signals Field for a given satellite found in <i>Table 134: Satellite and Signal Block</i> on the next page)</p> <div style="border: 1px solid black; padding: 5px; margin-top: 10px;">  <p>The byte data is received MSB first so each group of bytes (as defined by the number of needed bits) must be swapped prior to processing.</p> </div>	Uchar	# bytes	H+4
4	xxxx	32-bit CRC (ASCII only)	Hex	4	H+4+ (# bytes)
5	[CR][LF]	Sentence terminator (ASCII only)	-	-	-

Table 133: Header

Data Name	Description	Bits	Scale Factor
GNSS	<p>Indicates which satellite system data is encoded and in what order. When the bit is set the satellite data is included. Data for each system is encoded sequentially:</p> <p>Bit 0 = GPS Bit 1 = GLONASS Bit 2 = SBAS Bit 5 = Galileo Bit 6 = BeiDou Bit 7 = QZSS Bit 9 = NavIC</p>	16	1
Bit Sum:		16	
 This block is sent once per message			

Table 134: Satellite and Signal Block

Data Name	Range	Description	Bits	Scale Factor
Satellites	0... 1.84467E+19	<p>Indicates which satellites are present for this system and their order in the message. Each PRN is represented by a bit. (Bit 0 = PRN 1, Bit 1 = PRN 2, ...)</p> <p>Notes:</p> <ul style="list-style-type: none"> • GLONASS Satellite: This value represents the Slot ID of the satellite (range of 1 to 24 where Bit 0 = Slot ID 1). In the event the Slot ID is between 43 and 63, the actual GLONASS Slot ID has not yet been determined and has been replaced with a temporary Slot ID calculated using the GLONASS Frequency Number. See the GLONASS Frequency Number field in <i>Table 135: Measurement Block Header</i> on the next page for more details. • SBAS Satellite PRNs 120 to 158 are offset by 120. (Bit 0 = PRN 120, Bit 1 = 121, ...) • SBAS Satellite PRNs 183 to 191 are offset by 130 • QZSS Satellite PRNs are offset by 193 	64	1

Data Name	Range	Description	Bits	Scale Factor
Signals	0... 65535	Indicates which signals are present for this system and their order in the message. Each signal is represented by a bit as defined in <i>Table 140: Signal Bit Mask</i> on page 640.	16	1
Included Signals	0... mxn	A two dimensional field to tell the decoder which signals are present for each of the satellites. m = The number of rows equals the number of bits set to 1 found in the Satellites field. (Maximum number of PRNs in the satellite system) n = The number of columns equals the number of bits set to 1 found in the Signals field. (Maximum number of Signals in the satellite system)	mxn	
Bit Sum:			80 + mxn	
 This block is sent once for each bit set to 1 in the GNSS field found in <i>Table 133: Header</i> on the previous page.				

Table 135: Measurement Block Header

Data Name	Range	Description	Bits	Scale Factor
Data Format Flag	0... 1	Identifies what type of Measurement Block will be used: 0 = Reference (<i>Table 136: Primary Reference Signal Measurement Block</i> on the next page and <i>Table 137: Secondary Reference Signals Measurement Block</i> on page 636) 1 = Differential (<i>Table 138: Primary Differential Signal Measurement Block</i> on page 637 and <i>Table 139: Secondary Differential Signals Measurement Block</i> on page 639)	1	1
Ref Data Block ID	0... 7	This ID identifies to which reference data the Differential Data is linked. This value is incremented by 1 each time a new Reference Measurement Block is used.	3	1



Data Name	Range	Description	Bits	Scale Factor
GLONASS Frequency Number	0... 20 (-7 to +13)	<p>These bits are only present for GLONASS satellites in the Reference Data. This represents the GLONASS Frequency Number which identifies the frequency offset of the carrier frequency. The value will appear as a number between 0 and 20 which directly translates into a frequency offset number between -7 to +13.</p> <p>If the GLONASS Slot ID is unknown, a temporary Slot ID for this satellite will be set between 43 and 63 based on the GLONASS Frequency Number: $PRN = 63 - \text{GLONASS Frequency Number}$</p> <div style="border: 1px solid black; padding: 5px; margin-top: 10px;">  The GLONASS Frequency Number used in this calculation is the 0 to 20 value, not the adjusted -7 to +13 value. </div>	5	1
Bit Sum:			4 (Non-GLONASS)	9 (GLONASS)
<div style="border: 1px solid black; padding: 10px; margin: 10px auto; width: 80%;">  This block is sent once for each bit set to 1 in the Satellites field found in <i>Table 134: Satellite and Signal Block</i> on page 633. </div>				

Table 136: Primary Reference Signal Measurement Block

Data Name	Range	Description	Bits	Scale Factor
Parity Flag	0... 1	0 = Parity Unknown 1 = Parity Known	1	1
½ Cycle Flag	0... 1	0 = Half Cycle Not Added 1 = Half Cycle Added	1	1
C/No	0... 63.95	C/No	11	0.05 dBHz
Lock Time	0... 15	The Lock Time – See <i>Table 141: Lock Time</i> on page 641	4	1
Pseudorange Std Dev	0... 15	The Pseudorange Standard Deviation (m) – See <i>Table 143: Pseudorange Std Dev</i> on page 642	4	



Data Name	Range	Description	Bits	Scale Factor
ADR Std Dev	0... 15	The ADR Standard Deviation (cycles) – See <i>Table 142: ADR Std Dev</i> on page 641	4	
Primary Pseudorange	0... 68719476.74	The Pseudo Range of the 1st signal (Signals field in <i>Table 134: Satellite and Signal Block</i> on page 633). If this value equals $(2^{37}-1) = 137438953471$, it represents a signal that is not locked.	37	0.0005 m
PhaseRange – Primary Pseudorange	± 419.4303	(2's Complement) If this value equals $-(2^{23}-1) = -4194304$, it represents the signal is not locked.	23	0.0001 m
Primary Doppler	± 3355.4431	(2's Complement) If this value equals $-(2^{26}-1) = -33554432$, it represents an invalid Doppler.	26	0.0001 m/s
Bit Sum:			111	
<div style="border: 1px solid black; padding: 10px; margin-bottom: 10px;">  This block is sent once for the first bit set to 1 in the Included Signals field found in <i>Table 134: Satellite and Signal Block</i> on page 633. For any bits set to 1 after the first bit set to 1, refer to <i>Table 137: Secondary Reference Signals Measurement Block</i> below. </div> <div style="border: 1px solid black; padding: 10px;">  This table is for Reference blocks only, as indicated by the Data Format Flag (see <i>Table 135: Measurement Block Header</i> on page 634). </div>				

Table 137: Secondary Reference Signals Measurement Block

Data Name	Range	Description	Bits	Scale Factor
Parity Flag	0... 1	0 = Parity Unknown 1 = Parity Known	1	1
½ Cycle Flag	0... 1	0 = Half Cycle Not Added 1 = Half Cycle Added	1	1
C/No Indicator	0... 63.95	C/No	11	0.05 dBHz
Lock Time	0... 15	The Lock Time – See <i>Table 141: Lock Time</i> on page 641	4	1



Data Name	Range	Description	Bits	Scale Factor
Pseudorange Std Dev	0... 15	The Pseudorange Standard Deviation (m) – See <i>Table 143: Pseudorange Std Dev</i> on page 642	4	
ADR Std Dev	0... 15	The ADR Standard Deviation (cycles) – See <i>Table 142: ADR Std Dev</i> on page 641	4	
Pseudorange – Primary Signal Pseudorange	±262.1435	(2's Complement) If this value equals $-(2^{20}-1) = -524288$, it indicates the signal is not locked.	20	0.0005 m
Phaserange – Pseudorange	±419.4303	(2's Complement) If this value equals $-(2^{23}-1) = -4194304$, it indicates the signal is not locked.	23	0.0001 m
Doppler – Primary Doppler	±0.8191	(2's Complement) If this value equals $-(2^{14}-1) = -8192$, it indicates an invalid Doppler.	14	0.0001 m/s
Bit Sum:			82	
 This block is sent once for each bit set to 1 after the first bit set to 1 in the Included Signals field found in <i>Table 134: Satellite and Signal Block</i> on page 633.				
 This table is for Reference blocks only, as indicated by the Data Format Flag (see <i>Table 135: Measurement Block Header</i> on page 634).				

Table 138: Primary Differential Signal Measurement Block

Data Name	Range	Description	Bits	Scale Factor
Parity Flag	0... 1	0 = Parity Unknown 1 = Parity Known	1	1
½ Cycle Flag	0... 1	0 = Half Cycle Not Added 1 = Half Cycle Added	1	1
C/No	0... 63.95	C/No	11	0.05 dBHz
Lock Time	0... 15	The Lock Time – See <i>Table 141: Lock Time</i> on page 641	4	1



Data Name	Range	Description	Bits	Scale Factor
Pseudorange Std Dev	0... 15	The Pseudorange Standard Deviation (m) – See <i>Table 143: Pseudorange Std Dev</i> on page 642	4	
ADR Std Dev	0... 15	The ADR Standard Deviation (cycles) – See <i>Table 142: ADR Std Dev</i> on page 641	4	
Pseudorange – Predicted Pseudorange	± 131.0715	(2's Complement) If this value equals $-(2^{19}-1) = -262144$, it indicates a signal that is not locked. The Predicted Pseudorange = reference pseudorange plus (the reference doppler x time difference between the reference log and the differential log). The Reference log and Differential logs used must contain matching Ref Data Block ID references (<i>Table 135: Measurement Block Header</i> on page 634).	19	0.0005 m
Phaserange – Predicted Phaserange	± 3.2767	(2's Complement) If this value equals $-(2^{16}-1) = -32768$, it indicates the signal is not locked. The Predicted Phaserange = reference phaserange plus (the reference doppler x time difference between the reference log and the differential log). The Reference log and Differential logs used must contain matching Ref Data Block ID references (<i>Table 135: Measurement Block Header</i> on page 634).	16	0.0001 m
Doppler – Reference Doppler	± 13.1071	(2's Complement) If this value equals $-(2^{18}-1) = -131072$, it indicates an invalid Doppler. The Reference Doppler is the Doppler for that PRN and for that signal from the Reference log. The Reference log and Differential logs used must contain matching Ref Data Block ID references (<i>Table 135: Measurement Block Header</i> on page 634).	18	0.0001 m/s
Bit Sum:			78	
<p> This block is sent once for each bit set to 1 after the first bit set to 1 in the Included Signals field found in <i>Table 134: Satellite and Signal Block</i> on page 633. For any bits set to 1 after the first bit set to 1, refer to <i>Table 139: Secondary Differential Signals Measurement Block</i> on the next page.</p>				
<p> This table is for Differential blocks only, as indicated by the Data Format Flag (see <i>Table 135: Measurement Block Header</i> on page 634).</p>				

Table 139: Secondary Differential Signals Measurement Block

Data Name	Range	Description	Bits	Scale Factor
Parity Flag	0... 1	0 = Parity Unknown 1 = Parity Known	1	1
½ Cycle Flag	0... 1	0 = Half Cycle Not Added 1 = Half Cycle Added	1	1
C/No	0... 63.95	C/No	11	0.05 dBHz
Lock Time	0... 15	The Lock Time – See <i>Table 141: Lock Time</i> on page 641	4	1
Pseudorange Std Dev	0... 15	The Pseudorange Standard Deviation (m) – See <i>Table 143: Pseudorange Std Dev</i> on page 642	4	1
ADR Std Dev	0... 15	The ADR Std Dev (cycles)– See <i>Table 142: ADR Std Dev</i> on page 641	4	1
Pseudorange – Predicted Pseudorange	±131.0715	(2's Complement) If this value equals $-(2^{19}-1) = -262144$, it indicates the signal is not locked. The Predicted Pseudorange = reference pseudorange plus (the reference doppler x time difference between the reference log and the differential log). The Reference log and Differential logs used must contain matching Ref Data Block ID references (<i>Table 135: Measurement Block Header</i> on page 634).	19	0.0005 m
Phaserange – Predicted Phaserange	±3.2767	(2's Complement) If this value equals $-(2^{16}-1) = -32768$, it indicates the signal is not locked. The Predicted Phaserange = reference phaserange plus (the reference doppler x time difference between the reference log and the differential log). The Reference log and Differential logs used must contain matching Ref Data Block ID references (<i>Table 135: Measurement Block Header</i> on page 634).	16	0.0001 m



Data Name	Range	Description	Bits	Scale Factor
Doppler – Reference Doppler	±13.1071	(2's Complement) If this value equals $-(2^{14}-1) = -8192$, it indicates an invalid Doppler. The Reference Doppler is the Doppler for that PRN and for that signal from the Reference log. The Reference log and Differential logs used must contain matching Ref Data Block ID references (<i>Table 135: Measurement Block Header</i> on page 634).	14	0.0001 m/s
Bit Sum:			74	
 This block is sent once for each bit set to 1 after the first bit set to 1 in the Included Signals field found in <i>Table 134: Satellite and Signal Block</i> on page 633.				
 This table is for Differential blocks only, as indicated by the Data Format Flag (see <i>Table 135: Measurement Block Header</i> on page 634).				

Table 140: Signal Bit Mask

	GPS	GLONASS	SBAS	Galileo	BeiDou	QZSS	NavIC
Bit 1	L1CA	L1CA	L1CA	E1	B1I	L1CA	L5SPS
Bit 2			L5I	E5A	B1GEO		
Bit 3		L2CA		E5B	B2I	L2C	
Bit 4	L2Y	L2P		ALTBOC	B2GEO	L5Q	
Bit 5	L2C			E6C	B3I		
Bit 6	L2P	L3			B3GEO		
Bit 7	L5Q				B1CP		
Bit 8						L1C	
Bit 9					B2AP		
Bit 10							
Bit 11						L6P	
Bit 12				E6B			
Bit 13							
Bit 14							
Bit 15	L1C						

Table 141: Lock Time

Indicator (i)	Minimum Lock Time (ms)	Range of Indicated Lock Times (t represents the Lock Time) (ms)
0	0	$0 \leq t < 16$
1	16	$16 \leq t < 32$
2	32	$32 \leq t < 64$
3	64	$64 \leq t < 128$
4	128	$128 \leq t < 256$
5	256	$256 \leq t < 512$
6	512	$512 \leq t < 1024$
7	1024	$1024 \leq t < 2048$
8	2048	$2048 \leq t < 4096$
9	4096	$4096 \leq t < 8192$
10	8192	$8192 \leq t < 16384$
11	16384	$16384 \leq t < 32768$
12	32768	$32768 \leq t < 65536$
13	65536	$65536 \leq t < 131072$
14	131072	$131072 \leq t < 262144$
15	262144	$262144 \leq t$

Table 142: ADR Std Dev

ADR Std Dev (cycles)	
0	≤ 0.0039
1	≤ 0.0052
2	≤ 0.0070
3	≤ 0.0093
4	≤ 0.0124
5	≤ 0.0165
6	≤ 0.0221
7	≤ 0.0295

ADR Std Dev (cycles)	
8	≤ 0.0393
9	≤ 0.0525
10	≤ 0.0701
11	≤ 0.0935
12	≤ 0.1248
13	≤ 0.1666
14	≤ 0.2223
15	> 0.2223

Table 143: Pseudorange Std Dev

Pseudorange Std Dev (m)	
0	≤ 0.020
1	≤ 0.030
2	≤ 0.045
3	≤ 0.066
4	≤ 0.099
5	≤ 0.148
6	≤ 0.220
7	≤ 0.329
8	≤ 0.491
9	≤ 0.732
10	≤ 1.092
11	≤ 1.629
12	≤ 2.430
13	≤ 3.625
14	≤ 5.409
15	> 5.409

3.129 RANGEGPSL1

L1 version of the RANGE log

Platform: OEM719, OEM729, OEM7500, OEM7600, OEM7700, OEM7720, PwrPak7, SPAN CPT7, SMART7, SMART2

This log is identical to the **RANGE** log (see page 611) except that it only includes GPS L1 C/A observations.

Message ID: 631

Log Type: Synch

Recommended Input:

```
log rangegpsl1a ontime 30
```

ASCII Example:

```
#RANGEGPSL1A, COM1, 0, 57.0, FINESTEERING, 1337, 404766.000, 02000000, 5862, 1984;
10,
14, 0, 21773427.400, 0.037, -114420590.433332, 0.006, 2408.171, 49.9, 14963.280,
18109c04,
22, 0, 24822942.668, 0.045, -130445851.055756, 0.009, -3440.031, 48.0, 22312.971,
08109c24,
25, 0, 20831000.299, 0.033, -109468139.214586, 0.006, 1096.876, 50.7, 7887.840,
08109c44,
1, 0, 20401022.863, 0.032, -107208568.887106, 0.006, -429.690, 51.1, 10791.500,
18109c64,
24, 0, 23988223.932, 0.074, -126058964.619453, 0.013, 2519.418, 43.8, 493.550, 18109c84,
11, 0, 22154466.593, 0.043, -116423014.826717, 0.007, -1661.273, 48.4, 11020.952,
08109ca4,
5, 0, 24322401.516, 0.067, -127815012.260616, 0.012, -1363.596, 44.6, 6360.282,
18109cc4,
20, 0, 22294469.347, 0.043, -117158267.467388, 0.008, 2896.813, 48.5, 4635.968,
08109ce4,
30, 0, 23267589.649, 0.051, -122271969.418761, 0.009, 822.194, 47.0, 4542.270, 08109d04,
23, 0, 24975654.673, 0.058, -131247903.805678, 0.009, 3395.097, 45.9, 406.762, 18109d24
*be4b7d70
```



Since the RANGEGPSL1 log includes only GPS L1 C/A observations, it is smaller in size than the RANGE log which contains entries for multiple systems and signals. Use the RANGEGPSL1 log when data throughput is limited and you are only interested in GPS L1 C/A range data. For GPS L1 only models, RANGE and RANGEGPSL1 logs are identical.

Field	Field type	Description	Format	Binary Bytes	Binary Offset
1	RANGEGPSL1 header	Log header. See <i>Messages</i> on page 27 for more information.		H	0
2	# obs	Number of L1 observations with information to follow	Long	4	H
3	PRN	Satellite PRN number of range measurement (1-32)	Ushort	2	H+4
4	Reserved		Ushort	2	H+6
5	psr	Pseudorange measurement (m)	Double	8	H+8
6	psr std	Pseudorange measurement standard deviation (m)	Float	4	H+16
7	adr	Carrier phase, in cycles (accumulated Doppler range)	Double	8	H+20
8	adr std	Estimated carrier phase standard deviation (cycles)	Float	4	H+28
9	dopp	Instantaneous carrier Doppler frequency (Hz)	Float	4	H+32
10	C/No	Carrier to noise density ratio $C/No = 10[\log_{10}(S/N_0)]$ (dB-Hz)	Float	4	H+36
11	locktime	Number of seconds of continuous tracking (no cycle slipping)	Float	4	H+40
12	ch-tr-status	Tracking status (see <i>Table 121: Channel Tracking Status</i> on page 614)	Ulong	4	H+44
13...	Next PRN offset = $H + 4 + (\#obs \times 44)$				
14	xxxx	32-bit CRC (ASCII and Binary only)	Ulong	4	H+4+ (#obs x 44)
15	[CR][LF]	Sentence terminator (ASCII only)	-	-	-

3.130 RAWALM

Raw GPS L1 C/A Almanac data

Platform: OEM719, OEM729, OEM7500, OEM7600, OEM7700, OEM7720, PwrPak7, SPAN CPT7, SMART7, SMART2

This log contains the undecoded GPS almanac subframes as received from the satellite. For more information about Almanac data, refer to [An Introduction to GNSS](#) available on our web-site.

Message ID: 74

Log Type: Asynch

Recommended Input:

```
log rawalma onchanged
```

ASCII Example:

```
#RAWALMA, COM1, 0, 56.0, SATTIME, 1337, 405078.000, 02000000, cc1b, 1984; 1337, 589824.000, 43,
3, 8b04e4839f35433a5590f5aefd3900a10c9aaa6f40187925e50b9f03003f,
27, 8b04e483a1325b9cde9007f2fd5300a10da5562da3adc0966488dd01001a,
4, 8b04e483a1b44439979006e2fd4f00a10d15d96b3b021e6c6c5f23feff3c,
28, 8b04e483a3b05c5509900b7cfd5800a10cc483e2bfa1d2613003bd050017,
5, 8b04e483a43745351c90fcb0fd4500a10d8a800f0328067e5df8b6100031,
57, 8b04e483a6337964e036d74017509f38e13112df8dd92d040605eeaaaaaa,
6, 8b04e483a6b54633e390fa8bfd3f00a10d4facbc80b322528f62146800ba,
29, 8b04e483a8b05d47f7901b20fd5700a10ce02d570ed40a0a2216412400cb,
7, 8b04e483a935476dee90fb94fd4300a10d93aba327b7794ae853c02700ba,
...
1, 8b04e483d8b641305a901b9dfd5a00a10ce92f48f1ba0a5dccb7500003b,
25, 8b04e483dab25962259004fcfd4c00a10dc154eee5c555d7a2a5010d000d,
2, 8b04e483db37424aa6900720fd4f00a10c5ad89baa4dc1460790b6fc000f,
26, 8b04e483dd305a878c901d32fd5b00a10c902eb7f51db6b6ce95c701fff4*83cae97a
```



The OEM7 family of receivers automatically saves almanacs in their Non-Volatile Memory (NVM), therefore creating an almanac boot file is not necessary.

Field	Field type	Description	Format	Binary Bytes	Binary Offset
1	RAWALM header	Log header. See <i>Messages</i> on page 27 for more information.		H	0
2	ref week	Almanac reference week number	Ulong	4	H
3	ref secs	Almanac reference time (ms)	GPSec	4	H+4
4	#subframes	Number of subframes to follow	Ulong	4	H+8

Field	Field type	Description	Format	Binary Bytes	Binary Offset
5	svid	<p>SV ID (satellite vehicle ID)</p> <p>A value between 1 and 32 for the SV ID indicates the PRN of the satellite. Any other values indicate the page ID.</p> <div style="border: 1px solid black; padding: 5px; margin: 10px 0;">  <p>See section 20.3.3.5.1.1, Data ID and SV ID, of IS-GPS-200J for more details. To obtain copies of IS-GPS-200, refer to the GPS website (http://www.gps.gov/technical/icwg/).</p> </div>	Ushort	2	H+12
6	data	Subframe page data	Hex	30	H+14
7...	Next subframe offset = H+12+(#subframe x 32)				
8	xxxx	32-bit CRC (ASCII and Binary only)	Hex	4	H+12+ (#subframes x 32)
9	[CR][LF]	Sentence terminator (ASCII only)	-	-	-

3.131 RAWCNAVFRAME

Raw GPS CNAV frame data

Platform: OEM719, OEM729, OEM7500, OEM7600, OEM7700, OEM7720, PwrPak7, SPAN CPT7, SMART7, SMART2

This log provides raw frame data from signals which contain the CNAV message (L2C, L5).

Message ID: 1066

Log Type: Asynch

Recommended Input:

```
log rawcnavframea onnew
```

ASCII Example:

```
#RAWCNAVFRAMEA,COM1,0,63.0,SATTIME,1902,431718.000,02000020,ee56,13677;17,6,11,8b18b8c892cd499a403d89d3a5bfc05f500a1fff6007dff412e017a3c029ccff5d6001fc9a70*0d ddab32
```

Field	Field type	Description	Format	Binary Bytes	Binary Offset
1	RAWCNAVFRAME header	Log header. See <i>Messages</i> on page 27 for more information.		H	0
2	signal channel	Signal channel providing the bits	Ulong	4	H
3	PRN	Satellite PRN number	Ulong	4	H+4
4	frame ID	frame ID	Ulong	4	H+8
5	data	Raw frame data	Hex[38]	38	H+12
6	xxxx	32-bit CRC (ASCII and Binary only)	Hex	4	H+50
7	[CR][LF]	Sentence terminator (ASCII only)	-	-	-

3.132 RAWEPHEM

Raw GPS L1 C/A ephemeris

Platform: OEM719, OEM729, OEM7500, OEM7600, OEM7700, OEM7720, PwrPak7, SPAN CPT7, SMART7, SMART2

This log contains the raw binary information for subframes one, two and three from the GPS satellite L1 C/A signal with the parity information removed. Each subframe is 240 bits long (10 words - 24 bits each) and the log contains a total 720 bits (90 bytes) of information (240 bits x 3 subframes). This information is preceded by the PRN number of the satellite from which it originated. This message is not generated unless all 10 words from all 3 frames have passed parity.

Ephemeris data whose Time of Ephemeris (TOE) is older than six hours is not shown. Multiple logs are output, one for each GPS satellite with collected ephemeris information.

Message ID: 41

Log Type: Asynch

Recommended Input:

```
log rawephema onnew
```

ASCII Example:

```
#RAWEPHEMA, COM1, 30, 48.0, SATTIME, 2017, 215910.000, 02000008, 58ba, 14968;
8, 2017, 215984,
8b0f84464926f8500023bc389922867c68cea8010b0d34bb00fff5f10fbc,
8b0f844649ab0dfac632fe6b077ab8fbc101cbf3970702a10cf7c334bb16,
8b0f84464a2fffd51d287903005b2781e24627e6ef75369dffa4920dfe27*e26b8cb9
...
#RAWEPHEMA, COM1, 29, 48.0, SATTIME, 2017, 217440.000, 02000008, 58ba, 14968;
10, 2017, 223200,
8b0f8446c8a7f8500012fcc99922867c68cea801045e367e00ffef1817c6,
8b0f8446c9295efea1313adc677649fe7a01ea37a913e4a10d5206367e7e,
8b0f8446c9af003072eca2d5fff527313d1619108e3984d6ffa8df5e08ba*85ccfe5a
```



A way to use only one receiver and achieve better than 1 meter accuracy is to use precise orbit and clock files. Three types of GPS ephemeris, clock and earth orientation solutions are compiled by an elaborate network of GNSS receivers around the world all monitoring the satellite characteristics. IGS rapid orbit data is processed to produce files that correct the satellite clock and orbit parameters. Since there is extensive processing involved, these files are available on a delayed schedule from the US National Geodetic Survey at: www.ngs.noaa.gov/orbits

Precise ephemeris files are available today to correct GPS data which was collected a few days ago. All you need is one GNSS receiver and a computer to process on. Replace the ephemeris data with the precise ephemeris data and post-process to correct range values.

Field	Field type	Description	Format	Binary Bytes	Binary Offset
1	RAWEPHEM header	Log header. See <i>Messages</i> on page 27 for more information.		H	0
2	PRN	Satellite PRN number	Ulong	4	H
3	ref week	Ephemeris reference week number	Ulong	4	H+4
4	ref secs	Ephemeris reference time (s)	Ulong	4	H+8
5	subframe1	Subframe 1 data	Hex[30]	30	H+12
6	subframe2	Subframe 2 data	Hex[30]	30	H+42
7	subframe3	Subframe 3 data	Hex[30]	30	H+72
8	xxxx	32-bit CRC (ASCII and Binary only)	Hex	4	H+102
9	[CR][LF]	Sentence terminator (ASCII only)	-	-	-

3.133 RAWGPSSUBFRAME

Raw GPS L1 C/A subframe data

Platform: OEM719, OEM729, OEM7500, OEM7600, OEM7700, OEM7720, PwrPak7, SPAN CPT7, SMART7, SMART2

This log contains the raw GPS L1 C/A subframe data.

A raw GPS L1 C/A subframe is 300 bits in total. This includes the parity bits which are interspersed with the raw data ten times in six bit chunks, for a total of 60 parity bits. Note Field #5, below, has these 60 parity bits stripped out and only the raw subframe data remains, for a total of 240 bits.

Message ID: 25

Log Type: Asynch

Recommended Input:

```
log rawgpssubframea onnew
```

ASCII Example:

```
#RAWGPSSUBFRAMEA, COM1, 59, 62.5, SATTIME, 1337, 405348.000, 02000000, f690, 1984; 2, 22, 4,
8b04e483f3b17ee037a3732fe0fc8ccf074303ebdf2f6505f5aaaaaaaaa9, 2*41e768e4
...
#RAWGPSSUBFRAMEA, COM1, 35, 62.5, SATTIME, 1337, 405576.000, 02000000, f690, 1984; 4, 25, 2,
8b04e48406a8b9fe8b364d786ee827ff2f062258840ea4a10e20b964327e, 4*52d460a7
...
#RAWGPSSUBFRAMEA, COM1, 0, 62.5, SATTIME, 1337, 400632.000, 02000000, f690, 1984; 20, 9, 3,
8b04e4826aadff3557257871000a26fc34a31d7a300bede5ffa3de7e06af, 20*55d16a4a
```



The RAWGPSSUBFRAME log can be used to receive the data bits with the parity bits stripped out. Alternately, you can use the **RAWGPSWORD** log (see page 652) to receive the parity bits in addition to the data bits.

Field	Field type	Description	Format	Binary Bytes	Binary Offset
1	RAWGPSSUBFRAME header	Log header. See <i>Messages</i> on page 27 for more information.		H	0
2	decode #	Frame decoder number	Long	4	H
3	PRN	Satellite PRN number	Ulong	4	H+4
4	subframe id	Subframe ID	Ulong	4	H+8
5	data	Raw subframe data	Hex[30]	32 ¹	H+12

¹In the binary log case, an additional 2 bytes of padding are added to maintain 4-byte alignment.

Field	Field type	Description	Format	Binary Bytes	Binary Offset
6	signal channel	Signal channel number that the frame was decoded on	Ulong	4	H+44
7	xxxx	32-bit CRC (ASCII and Binary only)	Ulong	4	H+48
8	[CR][LF]	Sentence terminator (ASCII only)	-	-	-

3.134 RAWGPSWORD

Raw GPS L1 C/A navigation word

Platform: OEM719, OEM729, OEM7500, OEM7600, OEM7700, OEM7720, PwrPak7, SPAN CPT7, SMART7, SMART2

This message contains the framed GPS L1 C/A raw navigation words. Each log contains a new 30 bit navigation word (in the least significant 30 bits), plus the last 2 bits of the previous word (in the most significant 2 bits). The 30 bit navigation word contains 24 bits of data plus 6 bits of parity. The GPS reference time stamp in the log header is the time the first bit of the 30 bit navigation word was received. Only navigation data that has passed parity checking appears in this log. One log appears for each PRN being tracked every 0.6 seconds if logged ONNEW or ONCHANGED.

Message ID: 407

Log Type: Asynch

Recommended Input:

```
log rawgpsworda onnew
```

ASCII Example:

```
#RAWGPSWORDA, COM1, 0, 58.5, FINESTEERING, 1337, 405704.473, 02000000, 9b16, 1984; 14, 7ff
9f5dc*8e7b8721
```

...

```
#RAWGPSWORDA, COM1, 0, 57.0, FINESTEERING, 1337, 405783.068, 02000000, 9b16, 1984; 1, 93fe
ff8a*6dd62c81
```

...

```
#RAWGPSWORDA, COM1, 0, 55.5, FINESTEERING, 1337, 405784.882, 02000000, 9b16, 1984; 5, ffff
f8ce*a948b4de
```



The RAWGPSWORD log can be used to receive the parity bits in addition to the data bits. Alternately, you can use the RAWGPSSUBFRAME log which already has the parity bits stripped out

Field	Field type	Description	Format	Binary Bytes	Binary Offset
1	RAWGPSWORD header	Log header. See <i>Messages</i> on page 27 for more information.		H	0
2	PRN	Satellite PRN number	Ulong	4	H
3	nav word	Raw navigation word	Hex[4]	4	H+4
4	xxxx	32-bit CRC (ASCII and Binary only)	Ulong	4	H+8
5	[CR][LF]	Sentence terminator (ASCII only)	-	-	-

3.135 RAWSBASFRAME

Raw SBAS frame data

Platform: OEM719, OEM729, OEM7500, OEM7600, OEM7700, OEM7720, PwrPak7, SPAN CPT7, SMART7, SMART2

This log contains the raw SBAS frame data of 226 bits (8-bit preamble, 6-bit message type and 212 bits of data but without a 24-bit CRC). Only frame data with a valid preamble and CRC are reported.

Message ID: 973

Log Type: Asynch

Recommended Input:

```
log rawsbasframea onnew
```

ASCII Example:

```
#RAWSBASFRAMEA,COM1,0,91.0,SATTIME,1610,341534.000,02000000,58e4,38637;32,133,4
,c6115ffc00000c009ffc07004c089ffdfdfdfdfdfdf957bbb6bffffc0,32*5afc5f95
#RAWSBASFRAMEA,COM1,0,91.0,SATTIME,1610,341535.000,02000000,58e4,38637;32,133,2
,53084007ff9fffffc03002c0000f0009ffc004005ffd6b961e39b9fb80,32*db5dfa62
#RAWSBASFRAMEA,COM1,0,91.0,SATTIME,1610,341535.000,02000000,58e4,38637;35,135,2
,53084007ff9fffffc03002c0000f0009ffc004005ffd6b961e39b9fb80,35*b72ff2a0
...
#RAWSBASFRAMEA,COM1,0,90.0,SATTIME,1610,341539.000,02000000,58e4,38637;34,138,3
,9a0c4000009ffc009ffdfdfc007fb9ffdfdfc0000040315b9bb96fb95680,34*cb050361
```



The RAWSBASFRAME log output contains all the raw data required for an application to compute its own SBAS correction parameters.

Field	Field type	Description	Format	Binary Bytes	Binary Offset
1	RAWSBASFRAME header	Log header. See <i>Messages</i> on page 27 for more information.		H	0
2	decode #	Frame decoder number	Ulong	4	H
3	PRN	SBAS satellite PRN number	Ulong	4	H+4
4	SBAS frame ID	SBAS frame ID	Ulong	4	H+8
5	raw frame data	Raw SBAS frame data. There are 226 bits of data and 6 bits of padding.	Hex[29]	32 ¹	H+12

¹In the binary log case, an additional 3 bytes of padding are added to maintain 4-byte alignment.

Field	Field type	Description	Format	Binary Bytes	Binary Offset
6	signal channel	Signal channel number that the frame was decoded on.	Ulong	4	H+44
7	xxxx	32-bit CRC (ASCII and Binary only)	Ulong	4	H+48
8	[CR][LF]	Sentence terminator (ASCII only)	-	-	-

3.136 RAWSBASFRAME2

Raw SBAS frame data 2

Platform: OEM719, OEM729, OEM7500, OEM7600, OEM7700, OEM7720, PwrPak7, SPAN CPT7, SMART7, SMART2

This log contains the raw SBAS frame data of 226 bits (8-bit preamble, 6-bit message type and 212 bits of data but without a 24-bit CRC). It also contains the transmitted frequency. Only frame data with a valid preamble and CRC are reported.

Message ID: 2185

Log Type: Asynch

Recommended Input:

```
log rawsbasframe2a onnew
```

ASCII Example:

```
#RAWSBASFRAME2A,COM1,0,77.5,SATTIME,1977,514394.000,02000020,b39f,32768;135,209,2,1,0,3,c60d4009ffc018001ffc005ffdfbf9fffc00bfed79db9bb95b9540*9a75ce69
#RAWSBASFRAME2A,COM1,0,77.5,SATTIME,1977,514394.000,02000020,b39f,32768;138,207,2,1,0,4,c6125ffdfc005fffffbfe3fb9ffdfdfdfdfdfba3956abfffc0*9324a574
#RAWSBASFRAME2A,COM1,0,77.5,SATTIME,1977,514395.000,02000020,b39f,32768;135,208,1,0,0,4,53125ffdfc011ffc000007fe3fb5ffdfdfdfdfdfba3956abfffc0*69490ac5
#RAWSBASFRAME2A,COM1,0,78.5,SATTIME,1977,514395.000,02000020,b39f,32768;138,206,1,0,0,3,530c7ff9ffc017ff9ffff9ffdfbf9fffc003fe579db9bb95b9540*c7ca1531
```



The **RAWSBASFRAME2** log output contains all the raw data required for an application to compute its own SBAS correction parameters.

Field	Field Type	Description	Format	Binary Bytes	Binary Offset
1	RAWSBASFRAME2 header	Log header. See <i>Messages</i> on page 27 for more information.		H	0
2	PRN	SBAS satellite PRN number	Ulong	4	H
3	signal channel	Signal channel number that the frame was decoded on	Ulong	4	H+4
4	SBAS Signal Source	Identifies the source of the SBAS signal: 1 – SBASL1CA 2 – SBASL5I	Uchar	1	H+8

Field	Field Type	Description	Format	Binary Bytes	Binary Offset
5	SBAS Preamble Type	Identifies what preamble was used when tracking the SBAS signal: 0 – SBASL1CA 8-bit Preamble 1 – SBASL5I 8-bit Preamble	Uchar	1	H+9
6	Reserved		Ushort	2	H+10
7	SBAS frame ID	SBAS frame ID	Ulong	4	H+12
8	data	Raw SBAS frame data. There are 226 bits of data and 6 bits of padding.	Hex[29]	32 ¹	H+16
9	xxxx	32-bit CRC (ASCII and Binary only)	Ulong	4	H+48
10	[CR][LF]	Sentence terminator (ASCII only)	-	-	-

¹In the binary log case, an additional 3 bytes of padding are added to maintain 4-byte alignment.

3.137 REFSTATION

Base station position and health

Platform: OEM719, OEM729, OEM7500, OEM7600, OEM7700, OEM7720, PwrPak7, SPAN CPT7, SMART7

This log contains the ECEF Cartesian position of the base station as received through the RTCMV3 message. It also features a time tag, the health status of the base station and the station ID. This information is set at the base station using the **FIX** command (see page 124) and the **DGPSTXID** command (see page 105). See *Figure 6: The WGS84 ECEF Coordinate System* on page 392 for a definition of the ECEF coordinates.

The base station health, Field #6, may be one of 8 values (0 to 7). Values 0 through 5 indicate the scale factor that is multiplied with the satellite UDRE one-sigma differential error values. Below are values 0 to 5 and their corresponding UDRE scale factors:

0: 1 (Health OK) 0.75 2: 0.5 3: 0.3 4: 0.2 5: 0.1

The base station health field only applies to RTCM base stations. A value of 6 means the base station transmission is not monitored and a value of 7 means that the base station is not working.

Message ID: 175

Log Type: Asynch

Recommended Input:

```
log refstationa onchanged
```

ASCII Example:

```
#REFSTATIONA,COM1,0,66.5,FINESTEERING,1364,490401.124,82000000,4e46,2310;00000000,-1634532.443,-3664608.907,4942482.713,0,RTCMV3,"AAAA"*1e2a0508
```

Field	Field type	Description	Format	Binary Bytes	Binary Offset
1	REFSTATION header	Log header. See <i>Messages</i> on page 27 for more information.		H	0
2	status	Status of the base station information (see <i>Table 144: Base Station Status</i> on the next page)	Ulong	4	H
3	x	ECEF X value (m)	Double	8	H+4
4	y	ECEF Y value (m)	Double	8	H+12
5	z	ECEF Z value (m)	Double	8	H+20
6	health	Base station health, see the description at the start of this section	Ulong	4	H+28
7	stn type	Station type (see <i>Table 145: Station Type</i> on the next page)	Enum	4	H+32

Field	Field type	Description	Format	Binary Bytes	Binary Offset
8	stn ID	Base station ID	Char[5]	8 ¹	H+36
9	xxxx	32-bit CRC (ASCII and Binary only)	Ulong	4	H+44
10	[CR][LF]	Sentence terminator (ASCII only)	-	-	-

Table 144: Base Station Status

Bit #	Mask	Description	Bit = 0	Bit = 1
0	0x00000001	Validity of the base station	Valid	Invalid

Table 145: Station Type

Base Station Type		Description
Binary	ASCII	
0	NONE	Base station is not used
1 - 3	Reserved	
4	RTCMV3	Base station is RTCMV3



The REFSTATION log can be used for checking the operational status of a remotely located base station. You can verify that the base station is operating properly without traveling to it. This is especially useful for RTK work on long baselines.

¹In the binary log case, an additional 3 bytes of padding are added to maintain 4-byte alignment.

3.138 REFSTATIONINFO

Base Station position information

Platform: OEM719, OEM729, OEM7500, OEM7600, OEM7700, OEM7720, PwrPak7, SPAN CPT7, SMART7

This is an extended version of the REFSTATION log with latitude, longitude and ellipsoidal height of the base station in WGS84. In addition to the base station position, ARP height, antenna model name and antenna serial number are available if provided by the base station only through RTCMV3.

Message ID: 1325

Log Type: Asynch

Recommended Input:

```
log refstationinfoa onchanged
```

ASCII Example:

```
#REFSTATIONINFOA,USB1,0,89.5,EXACT,0,0.000,02000040,d38f,6782;51.116375174,-114.038254922,1048.502830628,WGS84,1.234,0,RTCMV3,"0","702GG","NVH05410007"*bedf8ece
```

Field	Field type	Description	Format	Binary Bytes	Binary Offset
1	REFSTATIONINFO header	Log header. See <i>Messages</i> on page 27 for more information.	H	0	
2	latitude	Latitude (degrees)	Double	8	H
3	longitude	Longitude (degrees)	Double	8	H+8
4	height	Ellipsoidal Height (m)	Double	8	H+16
5	datum	Datum ID number 61 = WGS84 63 = USER (default = WGS84)	Enum	4	H+24
6	ARP height	Base Antenna ARP (m)	Float	4	H+28
7	health	Base Station Health, see <i>Table 144: Base Station Status</i> on the previous page	Ulong	4	H+32
8	Ref Stn Type	Base Station Type, see (<i>Table 145: Station Type</i> on the previous page)	Enum	4	H+36
9	stn ID	Base Station ID	Char[5]	8 ¹	H+40

¹In the binary log case, an additional 3 bytes of padding are added to maintain 4-byte alignment.

Field	Field type	Description	Format	Binary Bytes	Binary Offset
10	Ant Model	Base Antenna Model Name	Char [32]	32	H+48
11	Ant Serial	Base Antenna Serial Number	Char [32]	32	H+80
12	xxxx	32-bit CRC (ASCII and Binary only)	Ulong	4	H+112
13	[CR][LF]	Sentence terminator (ASCII only)	-	-	-

3.139 ROVERPOS

Position using ALIGN

Platform: OEM719, OEM729, OEM7500, OEM7600, OEM7700, OEM7720, PwrPak7, SPAN CPT7, SMART7

ALIGN generates distance and bearing information between a master and rover receiver. This log outputs the position information of the rover when using the ALIGN feature. This log can only be output from a Y ALIGN model and can be output at both Master and Rover ends.



You must have an ALIGN capable receiver to use this log.



- ALIGN is useful for obtaining the relative directional heading of a vessel/body, separation heading between two vessels/bodies, or heading information with moving base and pointing applications.
- The log can be output at the Y model Rover only if it is receiving the RTCAREFEXT message from the Master. The log can be output at any Master if the Master is receiving HEADINGEXTB from the Rover. Refer to the NovAtel application note [APN-048](#) for details on HEADINGEXT (available at www.novatel.com/support/).
- ROVERPOS is dependent on the output frequency of the RTCAREFEXT message from the master to the rover.
- On dual antenna receivers, the **ROVERPOS** log outputs the position for the secondary antenna input.

Message ID: 1052

Log Type: Asynch

Recommended Input:

log roverposa onchanged

ASCII Example:

```
#ROVERPOSA, COM1, 0, 21.5, FINESTEERING, 1544, 340322.000, 02000008, 7453, 4655;
SOL_COMPUTED, NARROW_INT, 51.11605565964, -114.03854655975, 1055.8559, -16.9000,
WGS84, 0.0130, 0.0122, 0.0206, "RRRR", 0.0, 0.0, 13, 12, 12, 11, 0, 0, 0, 0*635b3a1c
```



Asynchronous logs, such as ROVERPOS, should only be logged ONCHANGED or ONNEW otherwise the most current data is not output when it is available. This is especially true of the ONTIME trigger, which may cause inaccurate time tags to result.

Field	Field Type	Description	Format	Binary Bytes	Binary Offset
1	ROVERPOS header	Log header. See <i>Messages</i> on page 27 for more information.		H	0
2	sol stat	Solution Status, see <i>Table 65: Solution Status</i> on page 374	Enum	4	H
3	pos type	Position Type see <i>Table 66: Position or Velocity Type</i> on page 375	Enum	4	H+4
4	lat	Rover WGS84 latitude (degrees)	Double	8	H+8
5	long	Rover WGS84 longitude (degrees)	Double	8	H+16
6	hgt	Rover MSL Height (m)	Double	8	H+24
7	undulation	Undulation (m)	Float	4	H+32
8	datum id#	Datum ID number 61 = WGS84 63 = USER (default = WGS84)	Enum	4	H+36
9	lat σ	Latitude standard deviation (m)	Float	4	H+40
10	long σ	Longitude standard deviation (m)	Float	4	H+44
11	hgt σ	Height standard deviation (m)	Float	4	H+48
12	stn id	Rover ID (default = "RRRR")	Char[4]	4	H+52
13	Reserved		Float	4	H+56
14	Reserved		Float	4	H+60
15	#SVs	Number of satellite tracked	Uchar	1	H+64
16	#solnSVs	Number of satellite in solution	Uchar	1	H+65
17	#obs	Number of satellites above elevation mask angle	Uchar	1	H+66
18	#multi	Number of satellites above elevation mask angle with multi-frequency signals.	Uchar	1	H+67
19	Reserved		Hex	1	H+68
20			Uchar	1	H+69
21			Uchar	1	H+70
22			Uchar	1	H+71
23	xxxx	32-bit CRC (ASCII and Binary only)	Hex	1	H+72
24	[CR][LF]	Sentence Terminator (ASCII only)	-	-	-

3.140 RTCMV3 Standard Logs

Platform: OEM719, OEM729, OEM7500, OEM7600, OEM7700, OEM7720, PwrPak7, SPAN CPT7, SMART7

NovAtel's RTCMV3 logs are implementations of the messages described by the RTCM SC-104 committee's "Differential GNSS (Global Navigation Satellite Systems) Services – Version 3" standard. These messages are primarily intended to support RTK operations. They are also an alternative raw data format to NovAtel's proprietary messages.

The RTCMV3 logs can be divided into several categories that are described below. An RTK base station must minimally transmit one or more observable message, together with one or more station and antenna message. The **GENERATERTKCORRECTIONS** command on page 135 illustrates an appropriate set of messages and is an easy way to configure logging.

Example Input:

```
interfacemode com2 none RTCMV3
fix position 51.1136 -114.0435 1059.4
thisantennatype NOV702
log com2 rtcml1006 ontime 10
log com2 rtcml1033 ontime 10 2
log com2 rtcml1004 ontime 1
log com2 rtcml1012 ontime 1
```

Example Input using MSM4 messages:

```
interfacemode com1 none rtcmv3 off
thisantennatype nov850
fix position 51.1136 -114.0435 1059.4
log com1 rtcml1006 ontime 10
log com1 rtcml1033 ontime 10 2
log com1 rtcml1074 ontime 1
log com1 rtcml1084 ontime 1
log com1 rtcml1094 ontime 1
log com1 rtcml1124 ontime 1
```

3.140.1 Legacy Observable Messages

The legacy observable messages contain GPS and GLONASS code and phase observables. The *extended* messages additionally contain the C/N0.

Table 146: Legacy Observable Messages

Log Name	Message ID	Description
RTCM1001	772	GPS L1-only observables, basic

Log Name	Message ID	Description
RTCM1002	774	GPS L1-only observables, extended
RTCM1003	776	GPS L1/L2 basic observables, basic
RTCM1004	770	GPS L1/L2 basic observables, extended
RTCM1009	885	GLONASS L1-only observables, basic
RTCM1010	887	GLONASS L1-only observables, extended
RTCM1011	889	GLONASS L1/L2 basic observables, basic
RTCM1012	891	GLONASS L1/L2 basic observables, extended

3.140.2 MSM Observable Messages

The Multiple Signal Messages (MSM) are observable messages for all current GNSS systems. They provide a standardized framework for message content and are designed to support future systems and signals.



Sending legacy (1001-1004 and 1009-1012) and MSM messages in the same stream can cause problems for remote RTK users and is not recommended.

Each GNSS system has a set of seven MSM types numbered from 1 to 7. The MSM type for each GNSS system provides the same generic information. Generally, as the MSM number increases, more information is available in the messages. For example, MSM1 for each GNSS system provides the code measurements for the system, while MSM3 provides both the code and phase.

The information encoded in each MSM variant is described in *Table 147: MSM Type Descriptions* below for the descriptions of each of the seven MSM types. For RTK operations, MSM3 is minimally recommended.

Table 147: MSM Type Descriptions

Message	Description
MSM1	Provides the code measurements.
MSM2	Provides the phase measurements.
MSM3	Provides the data from MSM1 (code) and MSM2 (phase) in a single message.
MSM4	Provides all the data from MSM3 (code and phase) and adds the CNR measurements.
MSM5	Provides all the data from MSM4 (code, phase and CNR) and adds the doppler measurements.
MSM6	Provides the same information as MSM4, but has extended resolution on the measurements.
MSM7	Provides the same information as MSM5, but has extended resolution on the measurements.

Table 148: MSM Log Names below lists the MSM message name and *Table 149: MSM Message IDs* below lists the message IDs.

Table 148: MSM Log Names

Message	GPS	GLONASS	Galileo	QZSS	BeiDou
MSM1	RTCM1071	RTCM1081	RTCM1091	RTCM1111	RTCM1121
MSM2	RTCM1072	RTCM1082	RTCM1092	RTCM1112	RTCM1122
MSM3	RTCM1073	RTCM1083	RTCM1093	RTCM1113	RTCM1123
MSM4	RTCM1074	RTCM1084	RTCM1094	RTCM1114	RTCM1124
MSM5	RTCM1075	RTCM1085	RTCM1095	RTCM1115	RTCM1125
MSM6	RTCM1076	RTCM1086	RTCM1096	RTCM1116	RTCM1126
MSM7	RTCM1077	RTCM1087	RTCM1097	RTCM1117	RTCM1127

Table 149: MSM Message IDs

Message	GPS	GLONASS	Galileo	QZSS	BeiDou
MSM1	1472	1479	1486	1648	1592
MSM2	1473	1480	1487	1649	1593
MSM3	1474	1481	1488	1650	1594
MSM4	1475	1482	1489	1651	1595
MSM5	1476	1483	1490	1652	1596
MSM6	1477	1484	1491	1653	1597
MSM7	1478	1485	1492	1654	1598

3.140.3 Station and Antenna Messages

The station and antenna messages listed in *Table 150: Station and Antenna Messages* on the next page provide the base station's coordinates and hardware. Remote RTK users require this information so that they can position themselves relative to a base station.

- Message Type 1005 provides the Earth-Centered, Earth-Fixed (ECEF) coordinates of the Antenna Reference Point (ARP). The ARP is an explicit physical point on the antenna, typically the center of its base. It is related to the antenna phase center from where the measurements are emitted via the Phase Center Offsets (PCOs). The PCOs can be set using the **THISANTENNAPCO** command (see page 302) or **THISANTENNATYPE** command (see page 304). If the PCOs are not set, then the coordinates transmitted by Message types 1005 and 1006 will be those that the receiver is fixed to by the **FIX** command (see page 124).
- Message Type 1006 is the same as 1005 but additionally provides the antenna height. This value is always set to zero by the receiver firmware.
- Message Type 1007 provides the base station antenna type. Conventionally, the antenna

name from the International GNSS Service (IGS) is used. The antenna name can be set using the **THISANTENNA** command (see page 304).

- Message Type 1008 is the same as 1007 but additionally provides the antenna serial number. The serial number is always set to null by the receiver firmware.
- Message Type 1033, like message types 1007 and 1008, also provides the antenna information. Message type 1033 additionally provides the receiver type and firmware version. The primary use of this information is to more-easily enable RTK rovers to fix their GLONASS ambiguities. This information is filled automatically and appropriately by the receiver firmware.

For a receiver operating as an RTK base station, the recommended messages to transmit are 1006 and 1033. With these messages remote RTK users have all the information describing the base station.

Table 150: Station and Antenna Messages

Log Name	Message ID	RTCM Message Type	Description
RTCM1005	765	1005	Stationary RTK Base Station Antenna Reference Point (ARP)
RTCM1006	768	1006	Stationary RTK Base Station ARP with Antenna Height
RTCM1007	852	1007	Extended Antenna Descriptor and Setup Information
RTCM1008	854	1008	Extended Antenna Reference Station Description and Serial Number
RTCM1033	1097	1033	Receiver and antenna descriptors

3.140.4 Ephemeris Messages

The ephemeris messages listed in *Table 151: Ephemeris Messages* below provide the satellite ephemerides. For RTK operations this information is optional, as RTK rovers will be downloading their own ephemerides directly from the satellites.

There are two messages for each ephemeris type. For the messages logged ONTIME (e.g. LOG RTCM1019 ONTIME 10) a single satellite's ephemeris is output at each ONTIME interval. The ephemerides will be cycled through in numerical order. For the messages logged ONCHANGED (e.g., LOG RTCM1019ASYNC ONCHANGED), new or changed ephemerides will be output as soon as they are available.

Table 151: Ephemeris Messages

Log Name	Message ID	RTCM Message Type	Description
RTCM1019	893	1019	GPS Ephemerides, logged ONTIME
RTCM1019ASYNC	2088	1019	GPS Ephemerides, logged ONCHANGED
RTCM1020	895	1020	GLONASS Ephemerides, logged ONTIME

Log Name	Message ID	RTCM Message Type	Description
RTCM1020ASYNC	2089	1020	GLONASS Ephemerides, logged ONCHANGED
RTCM1042	2171	1042	BeiDou Ephemerides, logged ONTIME
RTCM1042ASYNC	2170	1042	BeiDou Ephemerides, logged ONCHANGED
RTCM1044	2177	1044	QZSS Ephemerides, logged ONTIME
RTCM1044ASYNC	2176	1044	QZSS Ephemerides, logged ONCHANGED
RTCM1045	2173	1045	Galileo F/NAV Ephemerides, logged ONTIME
RTCM1045ASYNC	2172	1045	Galileo F/NAV Ephemerides, logged ONCHANGED
RTCM1046	2175	1046	Galileo I/NAV Ephemerides, logged ONTIME
RTCM1046ASYNC	2174	1046	Galileo I/NAV Ephemerides, logged ONCHANGED

3.141 RTKASSISTSTATUS

RTK ASSIST status

Platform: OEM719, OEM729, OEM7500, OEM7600, OEM7700, OEM7720, PwrPak7, SPAN CPT7, SMART7

This log provides information on the state of RTK ASSIST.

RTK ASSIST operates in two modes: coast and full assist. The RTKASSISTSTATUS log reports which mode is currently available. Coast mode is available as soon as the RTK ASSIST corrections are received from the L-Band satellite, while full assist mode requires a convergence period. In coast mode, position error growth during RTK correction outages is slightly worse than in full assist mode and RTK will not resume following a full signal outage until after RTK corrections are restored. Full assist gives the lowest position error growth during RTK correction outages, and makes it possible for RTK to resume even if there are complete GNSS signal outages during the RTK ASSIST period.

The RTK ASSIST ACTIVE state reported in the RTKASSISTSTATUS log is also reported in the RTKPOS and BESTPOS extended solution status field. See *Table 69: Extended Solution Status* on page 378.

The RTKASSISTSTATUS log reports the time remaining in the RTK ASSIST ACTIVE state. Once RTK ASSIST becomes active, the remaining time will count down from the time out set by the **RTKASSISTTIMEOUT** command (see page 235).

The corrections age reported in the RTKASSISTSTATUS log should typically be below 30 seconds. If the age exceeds this value, then L-Band tracking is likely degraded. The most likely cause of degraded L-Band tracking are obstructions between the antenna and the L-Band satellite.

Message ID: 2048

Log Type: Synch

Recommended Input:

```
log rtkassiststatusa ontime 5
```

ASCII Example:

```
#RTKASSISTSTATUSA,COM1,0,80.0,FINESTEERING,1932,491359.000,02000020,80fe,46672;  
ACTIVE,ASSIST,969.0,14.0*26e32616
```

Field	Field type	Description	Format	Binary Bytes	Binary Offset
1	RTKASSISTSTATUS header	Log header. See <i>Messages</i> on page 27 for more information.		H	0
2	State	State: INACTIVE (0) ACTIVE (1)	Enum	4	H

Field	Field type	Description	Format	Binary Bytes	Binary Offset
3	Mode	Mode: UNAVAILABLE (0) COAST (1) ASSIST (2)	Enum	4	H+4
4	Remaining time	Time remaining in seconds	Float	4	H+8
5	Corrections age	Age of the RTK ASSIST corrections in seconds. Maximum value of 120 seconds.	Float	4	H+12
6	xxxx	32-bit CRC (ASCII and Binary only)	Hex	4	H+16
7	[CR][LF]	Sentence terminator (ASCII only)	-	-	-

3.142 RTKDOP

DOP values for the satellites used in the RTK solution

Platform: OEM719, OEM729, OEM7500, OEM7600, OEM7700, OEM7720, PwrPak7, SPAN CPT7, SMART7

The RTKDOP log contains the Dilution Of Precision (DOP) values for the satellites being used in the RTK solution. Note that unlike the **PSRDOP** log (see page 581), the RTKDOP log is synchronous. DOP values will be calculated at the requested rate, up to a maximum rate of 1 Hz.

DOP values are a measure of the solution strength. Essentially, the DOPs reflect the geometry of the satellites used in the solution. Solutions with good counts of well-distributed satellites will have low DOPs and should be accurate and reliable. Solutions with fewer or poorly-distributed satellites will have high DOPs and be less accurate and reliable. As a rough guideline, PDOP values less than 4 imply a solution with reasonable geometry.

There can be many reasons for high DOP values. The most common reason is that there are obstructions limiting satellite visibility. Even if satellites are visible and being tracked they might still not be used in the solution if, for example, they are unhealthy or there aren't corrections available for them. The **RTKSATS** log (see page 677) will inform which satellites are being tracked and explain why a tracked satellite is not used in the solution.

The DOPs do not consider that different satellites or signals will be weighted differently in the solution. Therefore, they do not completely reflect the solution quality. Ultimately, the standard deviations reported in the **RTKPOS** log (see page 674) are the best reflection of the solution accuracy.

Message ID: 952

Log Type: Synch

Recommended Input:

```
log rtkdopa ontime 10
```

ASCII Example:

```
#RTKDOPA, COM1, 0, 60.0, FINESTEERING, 1449, 446982.000, 02000008, b42b, 3044; 2.3386, 1.9856, 0.9407, 1.5528, 1.2355, 10.0, 11, 21, 58, 6, 7, 10, 16, 18, 24, 26, 29, 41*85f8338b
```

Field	Field type	Description	Format	Binary Bytes	Binary Offset
1	RTKDOP header	Log header. See <i>Messages</i> on page 27 for more information.		H	0
2	GDOP	Geometric DOP	Float	4	H
3	PDOP	Position DOP	Float	4	H+4
4	HDOP	Horizontal DOP	Float	4	H+8
5	HTDOP	Horizontal and Time DOP	Float	4	H+12
6	TDOP	Time DOP	Float	4	H+16
7	elev mask	GPS elevation mask angle	Float	4	H+20

Field	Field type	Description	Format	Binary Bytes	Binary Offset
8	#sats	Number of satellites to follow	Ulong	4	H+24
9	sats	Satellites in use at time of calculation	Ulong	4	H+28
10	Next satellite offset = $H+28+(\text{\#sats} * 4)$				
11	xxxx	32-bit CRC (ASCII and Binary only)	Ulong	4	H+28+ (#sats * 4)
12	[CR][LF]	Sentence terminator (ASCII only)	-	-	-

3.143 RTKDOP2

DOP values for the satellites used in the RTK solution

Platform: OEM719, OEM729, OEM7500, OEM7600, OEM7700, OEM7720, PwrPak7, SPAN CPT7, SMART7

The RTKDOP2 log contains the Dilution Of Precision (DOP) values for the satellites being used in the RTK solution. This log is similar to the **RTKDOP** log (see page 670) but contains the per-system TDOPs; see the **RTKDOP** log on page 670 for more information on the DOPs.

Message ID: 1172

Log Type: Synch

Recommended Input:

```
log rtkdop2a ontime 10
```

ASCII Example:

```
#RTKDOP2A,COM1,0,80.0,FINESTEERING,1690,601478.000,02000008,ab50,43488;1.5000,1.1850,0.6580,0.9850,2,GPS,0.6530,GLONASS,0.6490*c5f1a25f
```

Field	Field type	Description	Format	Binary Bytes	Binary Offset
1	RTKDOP2 header	Log header. See <i>Messages</i> on page 27 for more information.		H	0
2	GDOP	Geometric DOP	Float	4	H
3	PDOP	Position DOP	Float	4	H+4
4	HDOP	Horizontal DOP	Float	4	H+8
5	VDOP	Vertical DOP	Float	4	H+12
6	#systems	Number of entries to follow	Ulong	4	H+16
7	system	See <i>Table 152: System Used for Timing</i> on the next page	Enum	4	H+20
8	TDOP	Time DOP (Dilution of Precision)	Float	4	H+24
9	Next satellite offset = H+20+(#systems * 8)				
10	xxxx	32-bit CRC (ASCII and Binary only)	Hex	4	H+20+ (#systems * 8)
11	[CR][LF]	Sentence terminator (ASCII only)	-	-	-

Table 152: System Used for Timing

Binary	ASCII
0	GPS
1	GLONASS
2	GALILEO
3	BEIDOU
4	NAVIC
99	AUTO ¹

¹AUTO is used only as a backup system (not available for primary system field).

3.144 RTKPOS

RTK low latency position data

Platform: OEM719, OEM729, OEM7500, OEM7600, OEM7700, OEM7720, PwrPak7, SPAN CPT7, SMART7

This log contains the low latency RTK position computed by the receiver, along with two status flags. In addition, it reports other status indicators, including differential age, which is useful in predicting anomalous behavior brought about by outages in differential corrections. This log is recommended for kinematic operation. Better accuracy can be obtained in static operation with the **MATCHEDPOS** log (see page 523).

With the system operating in an RTK mode, this log reflects if the solution is a good RTK low latency solution (from extrapolated base station measurements) or invalid. A valid RTK low latency solution is computed for up to 60 seconds after reception of the last base station observation. The degradation in accuracy, due to differential age, is reflected in the standard deviation fields. See also the **DGPSTXID** command (see page 105).



The RTK system in the receiver provides two kinds of position solutions. The Matched RTK position is computed with buffered observations, so there is no error due to the extrapolation of base station measurements. This provides the highest accuracy solution possible at the expense of some latency which is affected primarily by the speed of the differential data link. The **MATCHEDPOS** log (see page 523) contains the matched RTK solution and can be generated for each processed set of base station observations.

The Low-Latency RTK position is computed from the latest local observations and extrapolated base station observations. This supplies a valid RTK position with the lowest latency possible at the expense of some accuracy. The degradation in accuracy is reflected in the standard deviation. The amount of time that the base station observations are extrapolated is in the "differential age" field of the position log. The Low-Latency RTK system extrapolates for 60 seconds. The **RTKPOS** log contains the Low-Latency RTK position when valid, and an "invalid" status when a Low-Latency RTK solution could not be computed. The **BESTPOS** log (see page 371) contains either the low-latency RTK, PPP or pseudorange-based position, whichever has the smallest standard deviation.

Message ID: 141

Log Type: Synch

Recommended Input:

```
log rtkposa ontime 1
```

ASCII Example:

```
#RTKPOSA,COM1,0,54.5,FINESTEERING,1419,340040.000,02000040,176e,2724;
SOL_COMPUTED,NARROW_INT,51.11635911294,-114.03833103654,1063.8336,-16.2712,
WGS84,0.0179,0.0096,0.0174,"AAAA",1.000,0.000,12,11,11,11,0,01,0,33*0adb3e47
```



Consider the case of a racing car, on a closed circuit, requiring RTK operation. In this situation, you would have to send live data to the pits using a radio link.

RTK operation enables live centimeter level position accuracy. When answers are required in the field, the base station must transmit information to the rover in real-time. For RTK operation, extra equipment such as radios are required to transmit and receive this information. The base station has a corresponding base radio and the rover station has a corresponding rover radio.

Post-processing can provide post-mission position and velocity data using raw GNSS data collected from the car. The logs necessary for post-processing include:

```
RANGECMPB ONTIME 1
RAWEPHEMB ONNEW
```

These are examples of data collection for post-processing, and real-time operation. OEM7-based output is compatible with post-processing software from the NovAtel's Waypoint Products Group or refer to our website at www.novatel.com for more details.

Field	Field type	Description	Format	Binary Bytes	Binary Offset
1	RTKPOS header	Log header. See <i>Messages</i> on page 27 for more information.		H	0
2	sol status	Solution status (see <i>Table 65: Solution Status</i> on page 374)	Enum	4	H
3	pos type	Position type (see <i>Table 66: Position or Velocity Type</i> on page 375)	Enum	4	H+4
4	lat	Latitude (degrees)	Double	8	H+8
5	lon	Longitude (degrees)	Double	8	H+16
6	hgt	Height above mean sea level (m)	Double	8	H+24
7	undulation	Undulation - the relationship between the geoid and the WGS84 ellipsoid (m) <div style="border: 1px solid black; padding: 5px; margin-top: 10px;">  When using a datum other than WGS84, the undulation value also includes the vertical shift due to differences between the datum in use and WGS84. </div>	Float	4	H+32
8	datum id#	Datum ID number 61 = WGS84 63 = USER	Enum	4	H+36
9	lat σ	Latitude standard deviation (m)	Float	4	H+40

Field	Field type	Description	Format	Binary Bytes	Binary Offset
10	lon σ	Longitude standard deviation (m)	Float	4	H+44
11	hgt σ	Height standard deviation (m)	Float	4	H+48
12	stn id	Base station ID	Char[4]	4	H+52
13	diff_age	Differential age in seconds	Float	4	H+56
14	sol_age	Solution age in seconds	Float	4	H+60
15	#SVs	Number of satellites tracked	Uchar	1	H+64
16	#solnSVs	Number of satellites vehicles used in solution	Uchar	1	H+65
17	#ggL1	Number of satellites with L1/E1/B1 signals used in solution	Uchar	1	H+66
18	#solnMultiSVs	Number of satellites with multi-frequency signals used in solution	Uchar	1	H+67
19	Reserved		Hex	1	H+68
20	ext sol stat	Extended solution status (see <i>Table 69: Extended Solution Status</i> on page 378)	Hex	1	H+69
21	Galileo and BeiDou sig mask	Galileo and BeiDou signals used mask (see <i>Table 68: Galileo and BeiDou Signal-Used Mask</i> on page 378)	Hex	1	H+70
22	GPS and GLONASS sig mask	GPS and GLONASS signals used mask (see <i>Table 67: GPS and GLONASS Signal-Used Mask</i> on page 377)	Hex	1	H+71
23	xxxx	32-bit CRC (ASCII and Binary only)	Hex	4	H+72
24	[CR][LF]	Sentence terminator (ASCII only)	-	-	-

3.145 RTKSATS

Satellites used in RTKPOS solution

Platform: OEM719, OEM729, OEM7500, OEM7600, OEM7700, OEM7720, PwrPak7, SPAN CPT7, SMART7

This log lists the used and unused satellites for the corresponding RTKPOS solution. It also describes the signals of the used satellites and reasons for exclusions.

Message ID: 1174

Log Type: Synch

Recommended Input:

```
log rtkstats ontime 1
```

Abbreviated ASCII Example:

```
<RTKSATS COM1 0 60.5 FINESTEERING 1728 524924.000 02000000 95e7 11487
< 24
< GPS 3 GOOD 00000003
< GPS 5 GOOD 00000003
...
< GPS 23 GOOD 00000003
< GPS 30 GOOD 00000003
< GLONASS 1+1 GOOD 00000003
< GLONASS 2-4 GOOD 00000003
...
< GLONASS 20+2 GOOD 00000003
< GLONASS 21+4 GOOD 00000003
< BEIDOU 6 GOOD 00000003
< BEIDOU 11 GOOD 00000003
...
< BEIDOU 12 GOOD 00000003
< BEIDOU 13 GOOD 00000003
```

Field	Field type	Description	Format	Binary Bytes	Binary Offset
1	RTKSATS header	Log header. See <i>Messages</i> on page 27 for more information.		H	0
2	#entries	Number of records to follow	Ulong	4	H
3	system	Satellite system (refer to <i>Table 93: Satellite System</i> on page 477)	Enum	4	H+4
4	Satellite ID	Satellite identifiers	Ulong	4	H+8
5	Status	Satellite status. See <i>Table 71: Observation Statuses</i> on page 381	Enum	4	H+12

Field	Field type	Description	Format	Binary Bytes	Binary Offset
6	Signal mask	See Table 72: BESTSATS GPS Signal Mask on page 382, Table 73: BESTSATS GLONASS Signal Mask on page 383, Table 74: BESTSATS Galileo Signal Mask on page 383, and Table 75: BESTSATS BeiDou Signal Mask on page 383	Hex	4	H+16
7	Next satellite offset = H+4+(#sat x 16)				
8	xxxx	32-bit CRC (ASCII and Binary only)	Hex	4	H+4+ (#sat x 16)
9	[CR][LF]	Sentence terminator (ASCII only)	-	-	-

3.146 RTKVEL

RTK velocity

Platform: OEM719, OEM729, OEM7500, OEM7600, OEM7700, OEM7720, PwrPak7, SPAN CPT7, SMART7

This log contains the RTK velocity information computed by the receiver. In addition, it reports a velocity status indicator that is useful in indicating whether or not the corresponding data is valid and differential age is useful in predicting anomalous behavior brought about by outages in differential corrections. The velocity measurements sometimes have a latency associated with them. The time of validity is the time tag in the log minus the latency value.



Velocities from the RTK filter are calculated from the delta-position. In RTKVEL, the velocity type is the same as the position type.



In an RTKVEL log, the actual speed and direction of the receiver antenna over ground is provided. The receiver does not determine the direction a vessel, craft or vehicle is pointed (heading) but rather the direction of motion of the GNSS antenna relative to ground.

With the system operating in an RTK mode, this log reflects if the solution is a good RTK low latency solution (from extrapolated base station measurements) or invalid. A valid RTK low latency solution is computed for up to 60 seconds after reception of the last base station observation.

The velocity is computed from consecutive RTK low latency updates. As such, it is an average velocity based on the time difference between successive position computations and not an instantaneous velocity at the RTKVEL time tag. The velocity latency to be subtracted from the time tag is normally half the time between filter updates. Under default operation, the RTK low latency filter is updated at a rate of 2 Hz. This translates into a velocity latency of 0.25 seconds. The latency can be reduced by increasing the update rate of the RTK low latency filter by requesting the BESTVEL, RTKVEL, BESTPOS or RTKPOS messages at a rate higher than 2 Hz. For example, a logging rate of 10 Hz would reduce the velocity latency to 0.05 seconds. For integration purposes, the velocity latency should be applied to the record time tag.

Message ID: 216

Log Type: Synch

Recommended Input:

```
log rtkvela ontime 1
```

ASCII Example:

```
#RTKVELA,COM1,0,43.5,FINESTEERING,1364,496137.000,02100000,71e2,2310;  
SOL_COMPUTED,NARROW_INT,0.250,1.000,0.0027,207.645811,0.0104,0.0*f551cc42
```



Consider the case of an unmanned aircraft. A base station must send differential correction data to the remote aircraft. In this type of application, the aircraft's radio may pass the differential solution, for example RTKVEL, to the positioning system so it can process it and generate precise position information for the flight controls.

Field	Field type	Description	Format	Binary Bytes	Binary Offset
1	RTKVEL header	Log header. See <i>Messages</i> on page 27 for more information.		H	0
2	sol status	Solution status, see <i>Table 65: Solution Status</i> on page 374	Enum	4	H
3	vel type	Velocity type, see <i>Table 66: Position or Velocity Type</i> on page 375	Enum	4	H+4
4	latency	A measure of the latency in the velocity time tag in seconds. It should be subtracted from the time to give improved results	Float	4	H+8
5	age	Differential age in seconds	Float	4	H+12
6	hor spd	Horizontal speed over ground, in meters per second	Double	8	H+16
7	trk gnd	Actual direction of motion over ground (track over ground) with respect to True North, in degrees	Double	8	H+24
8	vert spd	Vertical speed, in meters per second, where positive values indicate increasing altitude (up) and negative values indicate decreasing altitude (down)	Double	8	H+32
9	Reserved		Float	4	H+40
10	xxxx	32-bit CRC (ASCII and Binary only)	Ulong	4	H+44
11	[CR] [LF]	Sentence terminator (ASCII only)	-	-	-

3.147 RTKXYZ

RTK Cartesian position and velocity

Platform: OEM719, OEM729, OEM7500, OEM7600, OEM7700, OEM7720, PwrPak7, SPAN CPT7, SMART7

This log contains the receiver's low latency position and velocity in ECEF coordinates. The position and velocity status fields indicate whether or not the corresponding data is valid. See *Figure 6: The WGS84 ECEF Coordinate System* on page 392 for a definition of the ECEF coordinates.

The velocity measurements have a latency associated with them. The time of validity is the time tag in the log minus the latency value.

With the system operating in an RTK mode, this log reflects if the solution is a good RTK low latency solution (from extrapolated base station measurements) or invalid. A valid RTK low latency solution is computed for up to 60 seconds after reception of the last base station observation. The degradation in accuracy due to differential age is reflected in the standard deviation fields. See also the **DGPSTXID** command (see page 105).

The velocity is computed from consecutive RTK low latency updates. As such, it is an average velocity based on the time difference between successive position computations and not an instantaneous velocity at the RTKVEL time tag. The velocity latency to be subtracted from the time tag is normally half the time between filter updates. Under default operation, the RTK low latency filter is updated at a rate of 2 Hz. This translates into a velocity latency of 0.25 seconds. The latency can be reduced by increasing the update rate of the RTK low latency filter by requesting the BESTXYZ message at a rate higher than 2 Hz. For example, a logging rate of 10 Hz would reduce the velocity latency to 0.05 seconds. For integration purposes, the velocity latency should be applied to the record time tag.

See also the **BESTXYZ** log on page 390 and **MATCHEDXYZ** log on page 528.

Message ID: 244

Log Type: Synch

Recommended Input:

```
log rtkxyza ontime 1
```

ASCII Example:

```
#RTKXYZA,COM1,0,56.0,FINESTEERING,1419,340041.000,02000040,3d88,2724;
SOL_COMPUTED,NARROW_INT,-1634531.5666,-3664618.0291,4942496.3230,0.0099,0.0219,
0.0115,SOL_COMPUTED,NARROW_INT,0.0030,0.0003,-0.0016,0.0198,0.0438,0.0230,
"AAAA",0.250,1.000,0.000,12,11,11,11,0,01,0,33*0497d146
```

Field	Field type	Description	Format	Binary Bytes	Binary Offset
1	RTKXYZ header	Log header. See <i>Messages</i> on page 27 for more information.		H	0
2	P-sol status	Solution status, see <i>Table 65: Solution Status</i> on page 374	Enum	4	H

Field	Field type	Description	Format	Binary Bytes	Binary Offset
3	pos type	Position type, see <i>Table 66: Position or Velocity Type</i> on page 375	Enum	4	H+4
4	P-X	Position X-coordinate (m)	Double	8	H+8
5	P-Y	Position Y-coordinate (m)	Double	8	H+16
6	P-Z	Position Z-coordinate (m)	Double	8	H+24
7	P-X σ	Standard deviation of P-X (m)	Float	4	H+32
8	P-Y σ	Standard deviation of P-Y (m)	Float	4	H+36
9	P-Z σ	Standard deviation of P-Z (m)	Float	4	H+40
10	V-sol status	Solution status, see <i>Table 65: Solution Status</i> on page 374	Enum	4	H+44
11	vel type	Velocity type, see <i>Table 66: Position or Velocity Type</i> on page 375	Enum	4	H+48
12	V-X	Velocity vector along X-axis (m)	Double	8	H+52
13	V-Y	Velocity vector along Y-axis (m)	Double	8	H+60
14	V-Z	Velocity vector along Z-axis (m)	Double	8	H+68
15	V-X σ	Standard deviation of V-X (m)	Float	4	H+76
16	V-Y σ	Standard deviation of V-Y (m)	Float	4	H+80
17	V-Z σ	Standard deviation of V-Z (m)	Float	4	H+84
18	stn ID	Base station identification	Char[4]	4	H+88
19	V-latency	A measure of the latency in the velocity time tag in seconds. It should be subtracted from the time to give improved results.	Float	4	H+92
20	diff_age	Differential age in seconds	Float	4	H+96
21	sol_age	Solution age in seconds	Float	4	H+100
22	#SVs	Number of satellites tracked	Uchar	1	H+104
23	#solnSVs	Number of satellite vehicles used in solution	Uchar	1	H+105
24	#ggL1	Number of satellites with L1/E1/B1 signals used in solution	Uchar	1	H+106
25	#solnMultiSVs	Number of satellites with multi-frequency signals used in solution	Uchar	1	H+107
26	Reserved		Char	1	H+108

Field	Field type	Description	Format	Binary Bytes	Binary Offset
27	ext sol stat	Extended solution status (see <i>Table 69: Extended Solution Status</i> on page 378)	Hex	1	H+109
28	Galileo and BeiDou sig mask	Galileo and BeiDou signals used mask (see <i>Table 68: Galileo and BeiDou Signal-Used Mask</i> on page 378)	Hex	1	H+110
29	GPS and GLONASS sig mask	GPS and GLONASS signals used mask (see <i>Table 67: GPS and GLONASS Signal-Used Mask</i> on page 377)	Hex	1	H+111
30	xxxx	32-bit CRC (ASCII and Binary only)	Ulong	4	H+112
31	[CR][LF]	Sentence terminator (ASCII only)	-	-	-

3.148 RXCONFIG

Receiver configuration

Platform: OEM719, OEM729, OEM7500, OEM7600, OEM7700, OEM7720, PwrPak7, SPAN CPT7, SMART7, SMART2

This log is used to output a list of all current command settings. When requested, an RXCONFIG log is output for each setting. See also the **LOGLIST** log on page 507 for a list of currently active logs. One log is output for each current command.

Message ID: 128

Log Type: Collection

Recommended Input:

```
log rxconfiga once
```

ASCII Example:

```
#RXCONFIGA, COM1, 71, 47.5, APPROXIMATE, 1337, 333963.260, 02000000, f702, 1984;
#ADJUST1PPSA, COM1, 71, 47.5, APPROXIMATE, 1337, 333963.260, 02000000, f702, 1984; OFF, ON
CE, 0*ba85a20b*91f89b07
#RXCONFIGA, COM1, 70, 47.5, APPROXIMATE, 1337, 333963.398, 02000000, f702, 1984;
#ANTENNAPOWERA, COM1, 70, 47.5, APPROXIMATE, 1337, 333963.398, 02000000, f702, 1984; ON*d
12f6135*8f8741be
#RXCONFIGA, COM1, 69, 47.5, APPROXIMATE, 1337, 333963.455, 02000000, f702, 1984;
#CLOCKADJUSTA, COM1, 69, 47.5, APPROXIMATE, 1337, 333963.455, 02000000, f702, 1984; ENABL
E*0af36d92*b13280f2
...
#RXCONFIGA, COM1, 7, 47.5, APPROXIMATE, 1337, 333966.781, 02000000, f702, 1984;
#STATUSCONFIGA, COM1, 7, 47.5, APPROXIMATE, 1337, 333966.781, 02000000, f702, 1984; CLEAR
, AUX2, 0*a6141e28*d0bba9f2
#RXCONFIGA, COM1, 2, 47.5, APPROXIMATE, 1337, 333967.002, 02000000, f702, 1984;
#SBASECUTOFFA, COM1, 2, 47.5, APPROXIMATE, 1337, 333967.002, 02000000, f702, 1984; -
5.000000000*b9b11096*2e8b77cf
#RXCONFIGA, COM1, 1, 47.5, FINESTEERING, 1337, 398382.787, 02000000, f702, 1984;
#LOGA, COM1, 1, 47.5, FINESTEERING, 1337, 398382.787, 02000000, f702, 1984; COM1, MARKPOSA
, ONNEW, 0.000000, 0.000000, NOHOLD*a739272d*6692c084
#RXCONFIGA, COM1, 0, 47.5, FINESTEERING, 1337, 400416.370, 02000000, f702, 1984;
#LOGA, COM1, 0, 47.5, FINESTEERING, 1337, 400416.370, 02000000, f702, 1984; COM2, PASSCOM2
A, ONCHANGED, 0.000000, 0.000000, NOHOLD*55fc0c62*17086d18
```



The embedded CRCs are flipped to make the embedded messages recognizable to the receiver. For example, consider the first embedded message above.

```
91f89b07: 10010001111110001001101100000111
          11100000110110010001111110001001:e0d91f89
```

The CRC is really **e0d91f89**.



Do not use undocumented commands or logs! Doing so may produce errors and void your warranty.



The RXCONFIG log can be used to ensure your receiver is correctly setup for your application.

Field	Field type	Description	Format	Binary Bytes	Binary Offset
1	RXCONFIG header	Log header. See <i>Messages</i> on page 27 for more information.	-	H	0
2	e header	Embedded header	-	h	H
3	e msg	Embedded message	Varied	a	H+h
4	e xxxx	Embedded (inverted) 32-bit CRC (ASCII and Binary only). The embedded CRC is inverted so that the receiver does not recognize the embedded messages as messages to be output but continues with the RXCONFIG message. If you wish to use the messages output from the RXCONFIG log, simply flip the embedded CRC around for individual messages	Ulong	4	H+h+a
5	xxxx	32-bit CRC (ASCII and Binary only)	Hex	4	H+h+a+4
6	[CR][LF]	Sentence terminator (ASCII only)	-	-	-

3.149 RXSTATUS

Receiver status

Platform: OEM719, OEM729, OEM7500, OEM7600, OEM7700, OEM7720, PwrPak7, SPAN CPT7, SMART7, SMART2

This log conveys various status parameters of the GNSS receiver system. These include the Receiver Status and Error words which contain several flags specifying status and error conditions. If an error occurs (shown in the Receiver Error word), the receiver idles all channels, turns off the antenna and disables the RF hardware as these conditions are considered to be fatal errors. The log contains a variable number of status words to allow for maximum flexibility and future expansion.

The receiver gives the user the ability to determine the importance of the status bits. In the case of the Receiver Status, setting a bit in the priority mask causes the condition to trigger an error. This causes the receiver to idle all channels, turn off the antenna and disable the RF hardware, the same as if a bit in the Receiver Error word is set. Setting a bit in an Auxiliary Status priority mask causes that condition to set the bit in the Receiver Status word corresponding to that Auxiliary Status.



Field #4, the receiver status word as represented in *Table 154: Receiver Status* on page 690, is also in Field #8 of the header. See the ASCII Example below and *Table 154: Receiver Status* on page 690 for clarification.

Refer also to Built-In Status Tests in the [SMART7 Installation and Operation User Manual](#).

Message ID: 93

Log Type: Asynch

Recommended Input:

```
log rxstatusa onchanged
```

Abbreviated ASCII Example:

```
#RXSTATUS USB1 0 67.0 FINESTEERING 2070 159546.023 02000000 2ae1 15824
00000000 5 (Receiver Error)
    02000000 00000000 00000000 00000000 (Receiver Status)
    00040000 00001008 00000000 00000000 (Aux1 Status)
    00000000 00000000 80000000 00000000 (Aux2 Status)
    80000000 00000000 00000000 00000000 (Aux3 Status)
    0030c000 00000000 ffffffff 00000000 (Aux4 Status)
```



Receiver errors automatically generate event messages. These event messages are output in RXSTATUSEVENT logs.

If you wish to disable all these messages without changing the bits, simply UNLOG the **RXSTATUSEVENT** logs on the appropriate ports. See the **UNLOG** command on page 322.

Field	Field type	Description	Format	Binary Bytes	Binary Offset
1	RXSTATUS header	Log header. See <i>Messages</i> on page 27 for more information.		H	0
2	error	Receiver error (see <i>Table 153: Receiver Error</i> on the next page). A value of zero indicates no errors	Ulong	4	H
3	# stats	Number of status codes (including Receiver Status). Each status code consists of 4 fields, the status, priority mask, event set mask and event clear mask. Each set is repeated for each status type. Note that for clarity, the Receiver Status, Auxiliary 1 Status, Auxiliary 2 Status, Auxiliary 3 Status and Auxiliary 4 status are listed separately in this message	Ulong	4	H+4
4	rxstat	Receiver status word (see <i>Table 154: Receiver Status</i> on page 690)	Ulong	4	H+8
5	rxstat pri	Receiver status priority mask	Ulong	4	H+12
6	rxstat set	Receiver status event set mask	Ulong	4	H+16
7	rxstat clear	Receiver status event clear mask	Ulong	4	H+20
8	aux1stat	Auxiliary 1 status word (see <i>Table 156: Auxiliary 1 Status</i> on page 692)	Ulong	4	H+24
9	aux1stat pri	Auxiliary 1 status priority mask	Ulong	4	H+28
10	aux1stat set	Auxiliary 1 status event set mask	Ulong	4	H+32
11	aux1stat clear	Auxiliary 1 status event clear mask	Ulong	4	H+36
12	aux2stat	Auxiliary 2 status word (see <i>Table 157: Auxiliary 2 Status</i> on page 694)	Ulong	4	H+40
13	aux2stat pri	Auxiliary 2 status priority mask	Ulong	4	H+44
14	aux2stat set	Auxiliary 2 status event set mask	Ulong	4	H+48
15	aux2stat clear	Auxiliary 2 status event clear mask	Ulong	4	H+52

Field	Field type	Description	Format	Binary Bytes	Binary Offset
16	aux3stat	Auxiliary 3 status word (see <i>Table 158: Auxiliary 3 Status</i> on page 695)	Ulong	4	H+56
17	aux3stat pri	Auxiliary 3 status priority mask	Ulong	4	H+60
18	aux3stat set	Auxiliary 3 status event set mask	Ulong	4	H+64
19	aux3stat clear	Auxiliary 3 status event clear mask	Ulong	4	H+68
20	aux4stat	Auxiliary 4 status word (see <i>Table 160: Auxiliary 4 Status</i> on page 697)	Ulong	4	H+72
21	aux4stat pri	Auxiliary 4 status priority mask	Ulong	4	H+76
22	aux4stat set	Auxiliary 4 status event set mask	Ulong	4	H+80
23	aux4stat clear	Auxiliary 4 status event clear mask	Ulong	4	H+84
24	xxxx	32-bit CRC (ASCII and Binary only)	Ulong	4	H+88
25	[CR][LF]	Sentence terminator (ASCII only)	-	-	-

Table 153: Receiver Error

Nibble	Bit	Mask	Description	Bit = 0	Bit = 1
N0	0	0x00000001	Dynamic Random Access Memory (DRAM) status RAM failure on an OEM7 card may also be indicated by a flashing red LED.	OK	Error
	1	0x00000002	Invalid firmware	OK	Error
	2	0x00000004	ROM status	OK	Error
	3	0x00000008	Reserved		
N1	4	0x00000010	Electronic Serial Number (ESN) access status	OK	Error
	5	0x00000020	Authorization code status	OK	Error
	6	0x00000040	Reserved		
	7	0x00000080	Supply voltage status	OK	Error

Nibble	Bit	Mask	Description	Bit = 0	Bit = 1
N2	8	0x00000100	Reserved		
	9	0x00000200	Temperature status (as compared against acceptable limits)	OK	Error
	10	0x00000400	MINOS status	OK	Error
	11	0x00000800	PLL RF status. Error with an RF PLL. See AUX2 status bits (<i>Table 157: Auxiliary 2 Status</i> on page 694) for individual PLL status	OK	Error
N3	12	0x00001000	Reserved		
	13	0x00002000			
	14	0x00004000			
	15	0x00008000	NVM status	OK	Error
N4	16	0x00010000	Software resource limit exceeded	OK	Error
	17	0x00020000	Model invalid for this receiver	OK	Error
	18	0x00040000	Reserved		
	19	0x00080000			
N5	20	0x00100000	Remote loading has begun	No	Yes
	21	0x00200000	Export restriction	OK	Error
	22	0x00400000	Safe Mode	OK	Error
	23	0x00800000	Reserved		
N6	24	0x01000000			
	25	0x02000000			
	26	0x04000000			
	27	0x08000000			
N7	28	0x10000000	Reserved		
	29	0x20000000			
	30	0x40000000			
	31	0x80000000		Component hardware failure	OK

Table 154: Receiver Status

Nibble	Bit	Mask	Description	Bit = 0	Bit = 1
N0	0	0x00000001	Error flag, see <i>Table 153: Receiver Error</i> on page 688	No error	Error
	1	0x00000002	Temperature status	Within specifications	Warning
	2	0x00000004	Voltage supply status	OK	Warning
	3	0x00000008	Primary antenna power status	Powered	Not powered
N1	4	0x00000010	LNA Failure	OK	Failure
	5	0x00000020	Primary antenna open circuit flag This flag is only available on certain products.	OK	Open, antenna disconnected
	6	0x00000040	Primary antenna short circuit flag This flag is only available on certain products.	OK	Short circuit detected
	7	0x00000080	CPU overload flag This flag is only available on certain products.	No overload	Overload
N2	8	0x00000100	COM port transmit buffer overrun. See AUX2 status bits (<i>Table 157: Auxiliary 2 Status</i> on page 694) for individual COM port status	OK	COM buffer overrun
	9	0x00000200	Reserved		
	10	0x00000400			
	11	0x00000800	Link overrun flag This flag indicates if any of the USB, ICOM, CCOM, NCOM or File ports are overrun. See AUX1, AUX2 and AUX3 status bits (<i>Table 156: Auxiliary 1 Status</i> on page 692, <i>Table 157: Auxiliary 2 Status</i> on page 694 or <i>Table 158: Auxiliary 3 Status</i> on page 695) for the specific port for which the buffer is overrun.	No overrun	Overrun

Nibble	Bit	Mask	Description	Bit = 0	Bit = 1
N3	12	0x00001000	Input overrun flag This flag is set if any of the receiver ports (COM, USB, ICOM or NCOM) experience an input overrun.	No overrun	Overrun
	13	0x00002000	Aux transmit overrun flag	No overrun	Overrun
	14	0x00004000	Antenna gain state See the AUX3 status bits (<i>Table 158: Auxiliary 3 Status</i> on page 695) for the antenna gain status.	OK	Out of range
	15	0x00008000	Jammer Detected See the AUX1 status bits (<i>Table 156: Auxiliary 1 Status</i> on the next page) for individual RF status	OK	Jammer Detected
N4	16	0x00010000	INS reset flag	No INS reset	INS reset
	17	0x00020000	IMU communication failure	No error	No IMU communication
	18	0x00040000	GPS almanac flag/UTC known	Valid	Invalid
	19	0x00080000	Position solution flag	Valid	Invalid
N5	20	0x00100000	Position fixed flag, see the FIX command on page 124	Not fixed	Fixed
	21	0x00200000	Clock steering status	Enabled	Disabled
	22	0x00400000	Clock model flag	Valid	Invalid
	23	0x00800000	External oscillator locked flag	Unlocked	Locked
N6	24	0x01000000	Software resource	OK	Warning
	25	0x06000000	Version bit 0	See <i>Table 155: Version Bits</i> on the next page	
	26		Version bit 1	See <i>Table 155: Version Bits</i> on the next page	
	27	0x08000000	Tracking mode	Normal tracking	HDR tracking
N7	28	0x10000000	Digital Filtering Enabled	Disabled	Enabled
	29	0x20000000	Auxiliary 3 status event flag	No event	Event
	30	0x40000000	Auxiliary 2 status event flag	No event	Event
	31	0x80000000	Auxiliary 1 status event flag	No event	Event

Table 155: Version Bits

Bit 25	Bit 26	Description
0	0	Interpret Status/Error Bits as OEM6 or earlier format
1	0	Interpret Status/Error Bits as OEM7 format
0	1	Reserved for a future version
1	1	Reserved for a future version

Table 156: Auxiliary 1 Status

Nibble	Bit	Mask	Description	Bit = 0	Bit = 1
N0	0	0x00000001	Jammer detected on RF1	OK	Jammer detected
	1	0x00000002	Jammer detected on RF2	OK	Jammer detected
	2	0x00000004	Jammer detected on RF3	OK	Jammer detected
	3	0x00000008	Position averaging	Off	On
N1	4	0x00000010	Jammer detected on RF4	OK	Jammer detected
	5	0x00000020	Jammer detected on RF5	OK	Jammer detected
	6	0x00000040	Jammer detected on RF6	OK	Jammer detected
	7	0x00000080	USB connection status	Connected	Not connected
N2	8	0x00000100	USB1 buffer overrun flag	No overrun	Overrun
	9	0x00000200	USB2 buffer overrun flag	No overrun	Overrun
	10	0x00000400	USB3 buffer overrun flag	No overrun	Overrun
	11	0x00000800	Reserved		

Nibble	Bit	Mask	Description	Bit = 0	Bit = 1
N3	12	0x00001000	Profile Activation Bit	OK	Error
	13	0x00002000	Throttled Ethernet Reception	OK	Throttled
	14	0x00004000	Reserved		
	15	0x00008000	Reserved		
N4	16	0x00010000	Reserved		
	17	0x00020000	Reserved		
	18	0x00040000	Ethernet not connected	Connected	Not connected
	19	0x00080000	ICOM1 buffer overrun flag	No overrun	Overrun
N5	20	0x00100000	ICOM2 buffer overrun flag	No overrun	Overrun
	21	0x00200000	ICOM3 buffer overrun flag	No overrun	Overrun
	22	0x00400000	NCOM1 buffer overrun flag	No overrun	Overrun
	23	0x00800000	NCOM2 buffer overrun flag	No overrun	Overrun
N6	24	0x01000000	NCOM3 buffer overrun flag	No overrun	Overrun
	25	0x02000000	Reserved		
	26	0x04000000	Reserved		
	27	0x08000000	Reserved		
N7	28	0x10000000	Reserved		
	29	0x20000000	Reserved		
	30	0x40000000	Reserved		
	31	0x80000000	IMU measurement outlier detected. Indicates when the SPAN system has detected an outlier in the IMU performance. May be treated as a notice unless the issue persists.	OK	Outlier detected

Table 157: Auxiliary 2 Status

Nibble	Bit	Mask	Description	Bit = 0	Bit = 1
N0	0	0x00000001	SPI Communication Failure	OK	Error
	1	0x00000002	I ² C Communication Failure	OK	Error
	2	0x00000004	COM4 buffer overrun flag	No overrun	Buffer Overrun
	3	0x00000008	COM5 buffer overrun flag	No overrun	Buffer Overrun
N1	4	0x00000010	Reserved		
	5	0x00000020	Reserved		
	6	0x00000040	Reserved		
	7	0x00000080	Reserved		
N2	8	0x00000100	Reserved		
	9	0x00000200	COM1 buffer overrun flag	OK	Buffer Overrun
	10	0x00000400	COM2 buffer overrun flag	OK	Buffer Overrun
	11	0x00000800	COM3 buffer overrun flag	OK	Buffer Overrun
N3	12	0x00001000	PLL RF1 unlock flag	OK	PLL Unlock
	13	0x00002000	PLL RF2 unlock flag	OK	PLL Unlock
	14	0x00004000	PLL RF3 unlock flag	OK	PLL Unlock
	15	0x00008000	PLL RF4 unlock flag	OK	PLL Unlock
N4	16	0x00010000	PLL RF5 unlock flag	OK	PLL Unlock
	17	0x00020000	PLL RF6 unlock flag	OK	PLL Unlock
	18	0x00040000	CCOM1 buffer overrun	OK	Buffer Overrun
	19	0x00080000	CCOM2 buffer overrun	OK	Buffer Overrun
N5	20	0x00100000	CCOM3 buffer overrun	OK	Buffer Overrun
	21	0x00200000	CCOM4 buffer overrun	OK	Buffer Overrun
	22	0x00400000	CCOM5 buffer overrun	OK	Buffer Overrun
	23	0x00800000	CCOM6 buffer overrun	OK	Buffer Overrun

Nibble	Bit	Mask	Description	Bit = 0	Bit = 1
N6	24	0x01000000	ICOM4 buffer overrun	OK	Buffer Overrun
	25	0x02000000	ICOM5 buffer overrun	OK	Buffer Overrun
	26	0x04000000	ICOM6 buffer overrun	OK	Buffer Overrun
	27	0x08000000	ICOM7 buffer overrun	OK	Buffer Overrun
N7	28	0x10000000	Secondary antenna power status	Powered	Not Powered
	29	0x20000000	Secondary antenna open circuit This flag is only available on certain products	OK	Open, antenna disconnected
	30	0x40000000	Secondary antenna short circuit This flag is only available on certain products	OK	Short circuit detected
	31	0x80000000	Reset loop detected	OK	Reset Detected

Table 158: Auxiliary 3 Status

Nibble	Bit	Mask	Description	Bit = 0	Bit = 1
N0	0	0x00000001	SCOM buffer overrun flag. This flag is set if any of the SCOM ports (SCOM1 – SCOM4) experience overrun.	No overrun	Overrun
	1	0x00000002	WCOM1 buffer overrun flag	No overrun	Overrun
	2	0x00000004	FILE buffer overrun flag	No overrun	Overrun
	3	0x00000008	Reserved		
N1	4	0x00000010	Antenna 1 Gain State	<i>Table 159: Antenna Gain State on the next page</i>	
	5	0x00000020			
	6	0x00000040	Antenna 2 Gain State	<i>Table 159: Antenna Gain State on the next page</i>	
	7	0x00000080			
N2	8	0x00000100	Reserved		
	9	0x00000200			
	10	0x00000400			
	11	0x00000800			

Nibble	Bit	Mask	Description	Bit = 0	Bit = 1
N3	12	0x00001000	Reserved		
	13	0x00002000			
	14	0x00004000			
	15	0x00008000			
N4	16	0x00010000	Reserved		
	17	0x00020000			
	18	0x00040000			
	19	0x00080000			
N5	20	0x00100000	Reserved		
	21	0x00200000			
	22	0x00400000			
	23	0x00800000			
N6	24	0x01000000	Reserved		
	25	0x02000000			
	26	0x04000000			
	27	0x08000000			
N7	28	0x10000000	Reserved		
	29	0x20000000	Web content is corrupt or does not exist	Content is OK	Error with content
	30	0x40000000	RF Calibration Data is present and in error	Data is OK	Data has an error
	31	0x80000000	RF Calibration Data is present	No data found	Data exists and has no errors

Table 159: Antenna Gain State

Bits 4-5 or Bits 6-7	Description
00	Antenna Gain in range

Bits 4-5 or Bits 6-7	Description
01	Antenna Gain Low This state indicates that the input signal is very weak (under -160 dBm/Hz). It can indicate the antenna is not operating correctly, the antenna is not suitable for NovAtel receivers, or there is no antenna connected.
10	Antenna Gain High. This state indicates that the input signal is very strong (above -120 dBm/Hz). This can be caused by a strong in-band interference or by too much signal gain or too many LNAs cascaded in the path.
11	Antenna Gain Anomaly. This state indicates that an anomaly has been detected for the input signal. It can be caused by strong in-band or out-of-band interference, or by the antenna being disconnected/changed during operation.

Table 160: Auxiliary 4 Status

Nibble	Bit	Mask	Description	Bit = 1
N0	0	0x00000001	GNSS Tracked Status	<60% of available satellites are tracked well
	1	0x00000002		<15% of available satellites are tracked well
	2	0x00000004	Reserved	
	3	0x00000008		
N1	4	0x00000010	Reserved	
	5	0x00000020		
	6	0x00000040		
	7	0x00000080		
N2	8	0x00000100	Reserved	
	9	0x00000200		
	10	0x00000400		
	11	0x00000800		

Nibble	Bit	Mask	Description	Bit = 1
N3	12	0x00001000	Clock freewheeling due to bad position integrity	Clock freewheeling
	13	0x00002000	Reserved	
	14	0x00004000	Usable RTK Corrections	<60% of expected corrections available
	15	0x00008000	Percentage of expected measurements which have timely RTK corrections (latency <20 seconds)	<15% of expected corrections available
N4	16	0x00010000	Bad RTK Geometry	PDOP >5.0
	17	0x00020000	Reserved	
	18	0x00040000		
	19	0x00080000	Long RTK Baseline	Baseline >50 km
N5	20	0x00100000	Poor RTK COM Link (poor correction quality)	Corrections quality ≤60%
	21	0x00200000	Poor ALIGN COM Link (poor correction quality)	Corrections quality ≤60%
	22	0x00400000	GLIDE Not Active	GLIDE not active
	23	0x00800000	Bad PDP Geometry	PDOP >5.0
N6	24	0x01000000	No TerraStar Subscription	No subscription
	25	0x02000000	Reserved	
	26	0x04000000		
	27	0x08000000		
N7	28	0x10000000	Bad PPP Geometry	PDOP >5.0
	29	0x20000000	Reserved	
	30	0x40000000	No INS Alignment	No alignment
	31	0x80000000	INS not converged	Not converged



Only GPS and GLONASS are considered in the Auxiliary 4 status word states.



For bits relating to RTK, ALIGN or INS, the bits will only be set if the receiver has that type of positioning is enabled via Auth Code.

3.150 RXSTATUSEVENT

Status event indicator

Platform: OEM719, OEM729, OEM7500, OEM7600, OEM7700, OEM7720, PwrPak7, SPAN CPT7, SMART7, SMART2

This log is used to output event messages as indicated in the **RXSTATUS** log (see page 686). An event message is automatically generated for all receiver errors, which are indicated in the receiver error word.

On start-up, the receiver is set to log **RXSTATUSEVENTA ONNEW HOLD** on all ports. You can remove this message using the **UNLOG** command (see page 322). To remove this log using an **UNLOGALL** command (see page 324), you must use the **True** option. Logging **RXSTATUSEVENT** on all ports is a factory default setting. If it is unlogged, the **RXSTATUSEVENT** log will not be collected until the next start-up. After a start-up, logging **RXSTATUSEVENT** on all ports will start again.



See also Built-In Status Tests in the [SMART7 Installation and Operation User Manual](#).

Message ID: 94

Log Type: Asynch

Recommended Input:

```
log rxstatuseventa onchanged
```

ASCII Example 1:

```
#RXSTATUSEVENTA,COM1,0,17.0,FREEWHEELING,1337,408334.510,02480000,b967,1984;STATUS,19,SET,"No Valid Position Calculated"*6de945ad
```

ASCII Example 2:

```
#RXSTATUSEVENTA,COM1,0,41.0,FINESTEERING,1337,408832.031,03000400,b967,1984;STATUS,10,SET,"COM3 Transmit Buffer Overrun"*5b5682a9
```



When a fatal event occurs (for example, in the event of a receiver hardware failure), a bit is set in the receiver error word, part of the **RXSTATUS** log (see page 686) to indicate the cause of the problem. Bit 0 is set in the receiver status word to show that an error occurred, the error strobe is driven high and the LED flashes red and yellow showing an error code. An **RXSTATUSEVENT** log is generated on all ports to show the cause of the error. Receiver tracking is disabled at this point but command and log processing continues to allow you to diagnose the error. Even if the source of the error is corrected at this point, the receiver must be reset to resume normal operation.

Field	Field type	Description	Format	Binary Bytes	Binary Offset
1	RXSTATUSEVENT header	Log header. See <i>Messages</i> on page 27 for more information.		H	0
2	word	The status word that generated the event message (see <i>Table 161: Status Word</i> below)	Enum	4	H
3	bit position	Location of the bit in the status word (see <i>Table 154: Receiver Status</i> on page 690, <i>Table 156: Auxiliary 1 Status</i> on page 692, <i>Table 157: Auxiliary 2 Status</i> on page 694, <i>Table 158: Auxiliary 3 Status</i> on page 695 or <i>Table 160: Auxiliary 4 Status</i> on page 697)	Ulong	4	H+4
4	event	Event type (see <i>Table 162: Event Type</i> on the next page)	Enum	4	H+8
5	description	This is a text description of the event or error	Char [32]	32	H+12
6	xxxx	32-bit CRC (ASCII and Binary only)	Ulong	4	H+44
7	[CR][LF]	Sentence terminator (ASCII only)	-	-	-

Table 161: Status Word

Binary	ASCII	Description
0	ERROR	Receiver Error word, see <i>Table 153: Receiver Error</i> on page 688
1	STATUS	Receiver Status word, see <i>Table 154: Receiver Status</i> on page 690
2	AUX1	Auxiliary 1 Status word, see <i>Table 156: Auxiliary 1 Status</i> on page 692
3	AUX2	Auxiliary 2 Status word see <i>Table 157: Auxiliary 2 Status</i> on page 694
4	AUX3	Auxiliary 3 Status word see <i>Table 158: Auxiliary 3 Status</i> on page 695
5	AUX4	Auxiliary 4 Status word see <i>Table 160: Auxiliary 4 Status</i> on page 697

Table 162: Event Type

Binary	ASCII	Description
0	CLEAR	Bit was cleared
1	SET	Bit was set

3.151 SAFEMODESTATUS

Safe Mode Status

Platform: OEM719, OEM729, OEM7500, OEM7600, OEM7700, OEM7720, PwrPak7, SPAN CPT7, SMART7, SMART2

This log provides additional information about the state of the receiver in the event that the *Safe Mode* error bit and/or *Reset Loop Detected* status bit are set in the **RXSTATUS** log (see page 686).

The data within this log is set at receiver start up and will not change over time.

For information about *Safe Mode*, see *Safe Mode* in the [SMART7 Installation and Operation User Manual](#) or [SMART2 Installation and Operation User Manual](#).

Message ID: 2060

Log Type: Asynch

Recommended Input:

```
log SAFEMODESTATUSUSA once
```

Abbreviated ASCII Example:

```
#SAFEMODESTATUSUSA,COM1,0,89.0,UNKNOWN,0,0.000,024c0020,8e55,32768;SAFE_MODE_OK,0,"Normal Operation."*29c7d28a
```

Field	Field Type	Description	Binary Format	Binary Bytes	Binary Offset
1	SAFEMODESTATUS header	Log header. See <i>Messages</i> on page 27 for more information.	-	H	0
2	Status	Safe Mode State. See <i>Table 163: Safe Mode States</i> on the next page	Enum	4	H
3	Reset Count	Number of resets since power up or a successful boot	Ulong	4	H+4
4	Description	String for additional information about the Safe Mode State	String	80	H+8
5	xxxx	32-bit CRC (ASCII and Binary only)	Ulong	4	H+88
6	[CR][LF]	Sentence terminator (ASCII only)	-	-	-

Table 163: Safe Mode States

Value	State	Safe Mode Error Bit	Reset Loop Detected Bit	Notes	Recovery Steps
0	SAFE_MODE_OK	0	0	Normal Operation. No reset loop detected.	No action required
1	SAFE_MODE_WARNING	0	1	An unexpected reset was detected. The receiver will operate as normal	No action required
2	SAFE_MODE_DISABLE_SATELLITE_DATA	0	1	Satellite Navigation Data previously saved to NVM is ignored in this state. As the receiver continues to track GNSS satellites, new data will be downloaded. There may be some delay in initial satellite acquisition as this will effectively be a Cold Start, but the receiver will otherwise operate as normal.	No action required
3	SAFE_MODE_DISABLE_NON_COMMUNICATION_NVM	1	1	All data previously saved to NVM that is not related to communication is ignored in this state. Communication ports (COM, USB, ICOM, etc.) will remain in the configuration previously saved by SAVECONFIG allowing the user to take corrective action.	Depending on what NVM data is causing the problem, a FRESET may resolve the issue. If a standard FRESET does not resolve the issue, see the FRESET command on page 127 for other NVM targets that may be causing the issue and could be removed.

Value	State	Safe Mode Error Bit	Reset Loop Detected Bit	Notes	Recovery Steps
4	SAFE_MODE_DISABLE_ALL_NVM	1	1	All data previously saved to NVM is ignored in this state.	See recovery steps for SAFE_MODE_DISABLE_NON_COMMUNICATION_NVM.
5	SAFE_MODE_DISABLE_AUTH	1	1	All data previously saved to NVM and all Auth Codes are ignored in this state.	Use the AUTH REMOVE command to remove the offending Auth Code. The AUTHCODES log (see page 356) can be used to determine what Auth Codes are currently loaded.
6	SAFE_MODE_FAILED	1	1	All data previously saved to NVM and all Auth Codes are ignored in this state.	This state is unexpected. The recovery steps for other states may apply.
7	SAFE_MODE_UNEXPECTED_MAIN_FIRMWARE	1	0 or 1	An error related to main firmware loading occurred.	Reload the main firmware.

3.152 SATEL4INFO

Displays the Satel 400 MHz radio configuration settings

Platform: SMART7 with RELAY7

Use this log to display the configuration settings of the Satel 400 MHz radio.

Message ID: 2216

Log Type: Async

Recommended Input:

```
log SATEL400INFO
```

ASCII Example:

```
#SATEL4INFOA,COM1,0,78.0,FINESTEERING,1997,507154.039,02004000,7499,32768;TRIMT  
ALK450S_T,438000000,438000000,12500,1000,TRUE*bf15bfb0
```

Field	Field Type	Description	Format	Binary Bytes	Binary Offset
1	SATEL4INFO header	Log header. See <i>Messages</i> on page 27 for more information.	-	H	0
2	protocol	Refer to <i>Table 164: Compatibility Mode</i> on the next page	ENUM	4	H
3	Freqtx	Transmit frequency in Hz	UINT	4	H+4
4	Freqrx	Receive frequency in Hz	UNIT	4	H+8
5	spacing	Channel spacing in Hz	UNIT	4	H+12
6	txpwr	Maximum transmit power in mW	UNIT	4	H+16
7	Fec	Forward correction error 0 = FALSE 1 = TRUE	ENUM	4	H+20
8	xxxx	32-bit CRC (ASCII or Binary only)	Hex	4	Variable
9	[CR][LF]	Sentence terminator (ASCII only)	-	-	-

Table 164: Compatibility Mode

Value	Enum	Mode
0	SATELLINE_3AS	Satellite-3AS
1	PACCREST_4FSK	PacCrest-4FSK
2	PACCREST_GMSK	PacCrest-GMSK
3	TRIMTALK450S_P	TrimTalk450s (PacCrest transmitter)
4	TRIMTALK450S_T	TrimTalk450s (Trimble transmitter)
5	PACCREST_FST	PacCrest-FST

3.153 SATEL9INFO

Displays the Satel UHF radio configuration settings

Platform: SMART7 with RELAY7

Use this log to display the configuration settings of the Satel UHF radio.

Message ID: 2220

Log Type: Async

Recommended Input:

```
log SATEL9INFO
```

ASCII Example:

```
#SATEL9INFOA,COM1,0,78.5,FINESTEERING,1997,507405.578,02004000,9dd6,32768;P2MP_
RX_SLAVE,4,-1,4,534,1,9,10,FF,FALSE,0,0,0,"1111111111111111"*2d430ec2
```

Field	Field Type	Description	Format	Binary Bytes	Binary Offset
1	SATEL9INFO header	Log header. See <i>Messages</i> on page 27 for more information.	-	H	0
2	modemmode	Radio role in network	ENUM	4	H
3	Leicachannel	Leica virtual channel ¹	INT	4	H+4
4	novchannel	Novariant virtual channel ²	INT	4	H+8
5	freqkey	Frequency key	UINT	4	H+12
6	nid	Network ID	UINT	4	H+16
7	minpktsize	Minimum packet size	UINT	4	H+20
8	maxpktsize	Maximum packet size	UINT	4	H+24
9	retrytimeout	Number of failed attempts to receive packets before the connection is dropped	UINT	4	H+28
10	subnet	Multipoint subnet: 00=Roaming FF=Disabled	UINT	4	H+32
11	repeaters	Boolean to specify if repeaters are present in the network	BOOL	4	H+36

¹If the current configuration does not translate to a valid Leica virtual channel, the reported value will be -1.

²If the current configuration does not translate to a valid Novariant virtual channel, the reported value will be -1.

Field	Field Type	Description	Format	Binary Bytes	Binary Offset
12	masterpacketrepeat	How many time master will repeat packets	UINT	4	H+40
13	txpower	The transmitter output power (mW)	UINT	4	H+44
14	hoptablever	Hop table version	UINT	4	H+48
15	freqzone	Frequency zone	FixedUChar Array	16	H+52
16	xxxx	32-bit CRC (ASCII or Binary only)	Hex	4	Variable
17	[CR][LF]	Sentence terminator (ASCII only)	-	-	-

Table 165: ASCII and Binary Values

Type	ASCII	Binary	Description
SATEL9INFO header	-	-	Log header. See <i>Messages</i> on page 27 for more information.
modemmode	P2MP_MASTER	2	Role in radio network
	P2MP_SLAVE	3	
	P2MP_RX_SLAVE	8	
leicachannel	1-9, -1		Leica virtual channel
novchannel	1-3824, -1		Novariant virtual channel
freqkey	0-14		Frequency key
nid	0-4095		Network ID
minpktsize	0-9		Minimum packet size
maxpktsize	0-9		Maximum packet size
retrytimeout	8-255		Number of failed attempts to receive packets before connection drops off
subnet	0x00, 0xFF		Multipoint subnet: 00=Roaming FF=Disabled
repeaters	FALSE	0	Boolean to specify if repeaters are present in the network
	TRUE	1	
masterpacketrepeat	0-9		Number of times master will repeat packets
txpower	0-1000		The transmitter output power (mW)
hoptablever	0-6		Hop table version
freqzone	"1111111111111111"		Frequency zone

3.154 SATELSTATUS

Delivers status updates for any asynchronous radio operations

Platform: SMART7 with RELAY7

Use this log to display the status of the last operation attempted on the RELAY7 radio. Settings are saved on the radio so it is not necessary to configure the radio for each session. The SATELSTATUS log reports UNDETECTED until the radio is used. If hardware power control is available, OFF may also be reported.



There is no state monitoring, so a radio can be detached after being configured and the status would not update until a radio command is issued.

Message ID: 2205

Log Type: Async

Recommended Input:

```
log SATELSTATUS onchanged
```

ASCII Example:

```
#SATELSTATUSA,COM1,0,68.5,FINESTEERING,1883,338273.235,03040040,ea7e,32768;UNDETECTED,OK,""*8b80bd71
```

```
#SATELSTATUSA,COM1,0,68.5,FINESTEERING,1883,338273.235,03040040,ea7e,32768;READY,OK,""*8b80bd71
```

```
#SATELSTATUSA,COM1,0,68.5,FINESTEERING,1883,338273.235,03040040,ea7e,32768;ERROR,TIMEOUT,""*8b80bd71
```

```
#SATELSTATUSA,COM1,0,68.5,FINESTEERING,1883,338273.235,03040040,ea7e,32768;ERROR,COMMAND_FAILED,"SL&FR=900.0000"*8b80bd71
```

Field	Field Type	Description	Format	Binary Bytes	Binary Offset
1	SATELSTATUS header	Log header. See <i>Messages</i> on page 27 for more information.	-	H	0
2	state	State of the radio. See <i>Table 166: Radio State</i> on the next page.	ENUM	4	H
3	error	Error type. See <i>Table 167: Error Types</i> on the next page.	UINT	4	H+4
4	error_source	Last SATEL radio command issued	String	Variable	H+8
5	xxxx	32-bit CRC (ASCII or Binary only)	Hex	4	Variable
6	[CR][LF]	Sentence terminator (ASCII only)	-	-	-

Table 166: Radio State

ASCII	Binary	Description
OFF	0	The radio power is configured OFF
DETECTING	1	The radio is being queried for identity and current configuration
UNDETECTED	2	The radio may be operating but it must be detected before responding to configuration commands
READY	3	The radio is operating and ready to respond to configuration commands
BUSY	4	The radio is being configured. Data may be interrupted
ERROR	5	The radio is in an error state

Table 167: Error Types

ASCII	Binary	Description
NONE	0	Error type
COMMAND_FAILED	1	
TIMEOUT	2	

3.155 SATVIS2

Satellite visibility

Platform: OEM719, OEM729, OEM7500, OEM7600, OEM7700, OEM7720, PwrPak7, SPAN CPT7, SMART7, SMART2

This log contains satellite visibility data for all available systems with additional satellite and satellite system information. One log is output for each available satellite system.



1. The SATVIS2 log is meant to provide a brief overview. The satellite positions and velocities used in the computation of this log are based on Almanac orbital parameters, not the higher precision Ephemeris parameters. BeiDou is an exception, it uses ephemeris only.
2. In the SATVIS2 log output, there may be double satellite number entries. These are GLONASS antipodal satellites in the same orbit plane separated by 180 degrees latitude. Refer to the GLONASS section of [An Introduction to GNSS](#) available on our website.
3. The SATVIS2 log is generated every 10 seconds. If the log is requested at a faster rate than ontime 10, it will be output at the requested rate, but will only be updated every 10 seconds.

Message ID: 1043

Log Type: Asynch

Recommended Input:

```
log satvis2a onchanged
```

Abbreviated ASCII Example:

```
<SATVIS2 COM1 6 49.0 FINESTEERING 2073 326280.000 02000000 a867 15761
<  GPS TRUE TRUE 31
<   21 0 85.7 308.7 251.181 251.142
<   20 0 57.7 238.7 1991.844 1991.805
...
<   3 0 -73.4 245.4 1009.468 1009.429
<   17 0 -75.6 51.5 232.697 232.658

<SATVIS2 COM1 5 49.0 FINESTEERING 2073 326280.000 02000000 a867 15761
<  GLONASS TRUE TRUE 24
<   23+3 0 70.8 325.6 1413.800 1413.760
<   8+6 0 67.3 185.7 1741.148 1741.109
...
<   4+6 1 -74.6 8.9 -1209.114 -1209.153
<   19+3 0 -87.2 239.5 -3.311 -3.351

<SATVIS2 COM1 4 49.0 FINESTEERING 2073 326280.000 02000000 a867 15761
<  SBAS TRUE FALSE 3
<   131 0 31.6 183.8 0.009 -0.030
<   138 0 31.3 171.3 0.011 -0.028
<   133 0 29.9 199.2 0.005 -0.034
```



```

<SATVIS2 COM1 3 49.0 FINESTEERING 2073 326280.000 02000000 a867 15761
<  GALILEO TRUE TRUE 22
<   13 0 66.2 123.9 -1154.174 -1154.213
<   8 0 60.6 98.2 70.268 70.229
...
<   4 0 -70.2 277.2 -31.546 -31.585
<   11 0 -74.7 303.9 759.647 759.608

<SATVIS2 COM1 2 49.0 FINESTEERING 2073 326280.000 02000000 a867 15761
<  QZSS TRUE TRUE 4
<   195 0 7.5 305.9 49.000 48.961
<   194 0 0.3 296.8 -387.954 -387.993
<   199 0 -25.6 293.2 1.000 0.961
<   193 0 -43.9 249.5 494.171 494.132

<SATVIS2 COM1 1 49.0 FINESTEERING 2073 326280.000 02000000 a867 15761
<  BEIDOU TRUE FALSE 17
<   21 0 76.7 146.7 390.834 390.795
<   34 0 73.6 203.8 -682.700 -682.739
...
<   20 0 -49.6 36.0 -2240.050 -2240.088
<   29 0 -56.0 124.4 -1689.012 -1689.051

```

Field	Field type	Description	Format	Binary Bytes	Binary Offset
1	SATVIS2 header	Log header. See <i>Messages</i> on page 27 for more information.		H	0
2	Satellite System	GNSS satellite system identifier. See <i>Table 93: Satellite System</i> on page 477	Enum	4	H
3	sat vis	Is satellite visibility valid? 0 = FALSE 1 = TRUE	Enum	4	H+4
4	almanac flag	Was complete almanac used? 0 = FALSE 1 = TRUE	Enum	4	H+8
5	#sat	Number of satellites with data to follow	Ulong	4	H+12

Field	Field type	Description	Format	Binary Bytes	Binary Offset
6	Satellite ID	In binary logs, the satellite ID field is 4 bytes. The 2 lowest order bytes, interpreted as a USHORT, are the system identifier: for instance, the PRN for GPS or the slot for GLONASS. The 2 highest-order bytes are the frequency channel for GLONASS, interpreted as a SHORT and zero for all other systems. In ASCII and abbreviated ASCII logs, the satellite ID field is the system identifier. If the system is GLONASS and the frequency channel is not zero, then the signed channel is appended to the system identifier. For example, slot 13, frequency channel -2 is output as 13-2. For more information, refer to <i>PRN Numbers</i> on page 46	Ulong	4	H+16
7	health	Satellite health  Satellite health values may be found in the applicable Interface Control Document for each system.	Ulong	4	H+20
8	elev	Elevation (degrees)	Double	8	H+24
9	az	Azimuth (degrees)	Double	8	H+32
10	true Doppler	Theoretical Doppler of satellite - the expected Doppler frequency based on a satellite's motion relative to the receiver. It is computed using the satellite's coordinates and velocity along with the receiver's coordinates and velocity (Hz).	Double	8	H+40
11	apparent Doppler	Apparent Doppler for this receiver - the same as Theoretical Doppler above but with clock drift correction added (Hz).	Double	8	H+48
12	Next satellite offset = H + 16 + (#sat x 40)				
13	xxxx	32-bit CRC (ASCII and Binary only)	Ulong	4	H+16+ (#sat x 40)
14	[CR][LF]	Sentence terminator (ASCII only)	-	-	-

3.156 SATXYZ2

Satellite positions in ECEF Cartesian coordinates

Platform: OEM719, OEM729, OEM7500, OEM7600, OEM7700, OEM7720, PwrPak7, SPAN CPT7, SMART7, SMART2

When combined with a RANGE log, this data set contains the decoded satellite information necessary to compute the solution: satellite coordinates (ECEF WGS84), satellite clock correction, ionospheric corrections and tropospheric corrections. See the calculation examples in the usage box below. Only those satellites used in the corresponding PSRPOS solution are reported here. See also *Figure 6: The WGS84 ECEF Coordinate System* on page 392.

Message ID: 1451

Log Type: Synch

Recommended Input:

```
log satxyz2 ontime 1
```

Abbreviated ASCII Example:

```
<SATXYZ2 COM1 0 43.0 FINESTEERING 2073 326597.000 02000000 7513 15761
< 31
< GPS 13 13292381.0861 -9204057.4856 20943772.2872 -12315.672 1.730 4.040
0.0 0.0
< GPS 26 -26171343.8441 -3995818.7265 3158269.4974 15742.110 3.276 10.040
0.0 0.0
< GPS 10 -22871286.2136 -11539483.0577 7490020.1157 -23362.172 2.518 4.049
0.0 0.0
...
< QZSS 195 -26852309.2176 25168047.7930 25627104.8820 -943.845 3.588 14.392
0.0 0.0
< GLONASS 23+3 -7728588.2303 -9923997.7486 22179613.4745 77256.655 4.535
2.209 0.0 0.0
< GLONASS 22-3 2062133.9271 -23859927.8705 8944205.1074 -53417.457 5.714
3.233 0.0 0.0
< GLONASS 15 -1568588.2687 11620631.2286 22680731.2560 31246.746 4.928 9.575
0.0 0.0
...
< GALILEO 26 -15009834.0035 -6744628.6348 24605291.2086 1211027.652 3.764
2.482 0.0 0.0
< GALILEO 13 -1405515.6484 -23638629.2714 17758202.4136 118018.035 3.897
2.360 0.0 0.0
< GALILEO 7 -12398598.1739 -26308725.3107 5470967.1516 -82852.430 4.513
3.301 0.0 0.0
...
< BEIDOU 11 -13808280.9446 -10084397.5362 22092795.5021 23811.128 -0.969
2.316 0.0 0.0
< BEIDOU 10 -1132944.7407 26163154.0839 33245955.0163 -69500.475 0.925
16.645 0.0 0.0
< BEIDOU 14 -24527716.7042 -12609403.1954 -4035069.5018 153346.639 1.497
13.392 0.0 0.0
...
```



The OEM7 family defines ionospheric and tropospheric corrections positively which means that ionospheric and tropospheric corrections are added to the geometric ranges or subtracted from the measured pseudoranges. A positive clock offset indicates the clock is running ahead of the reference time. For example:

$$P = p + pd + c(dt - dT) + d(\text{ion}) + d(\text{trop}) + E_p$$

is equivalent to

$$P - c(dt - dT) - d(\text{ion}) - d(\text{trop}) = p + pd + E_p$$

where

P = measured pseudorange
 p = geometric range
 pd = orbit error
 dt = satellite clock offset
 dT = receiver clock offset
 d (ion) = ionospheric delay
 d (trop) = tropospheric delay
 c = speed of light
 E_p = noise and multipath



Note that when dual frequency ionosphere corrections are used, the corrections include receiver biases. Consequently, the correction does not provide a measure of the ionosphere delay in an absolute sense.

Field	Field Type	Description	Format	Binary Bytes	Binary Offset
1	SATXYZ2 header	Log header. See <i>Messages</i> on page 27 for more information.	-	H	0
2	#sat	Number of satellites to follow	Ulong	4	H
3	System	Satellite system (refer to <i>Table 93: Satellite System</i> on page 477)	Enum	4	H+4
4	Satellite ID	Satellite ID	Ulong	4	H+8
5	X	Satellite X co-ordinates (ECEF,m)	Double	8	H+12
6	Y	Satellite Y co-ordinates (ECEF,m)	Double	8	H+20
7	Z	Satellite Z co-ordinates (ECEF,m)	Double	8	H+28
8	clk corr	Satellite clock correction (m)	Double	8	H+36
9	iono delay	Ionosphere delay (m)	Double	8	H+44
10	tropo delay	Troposphere delay (m)	Double	8	H+52

Field	Field Type	Description	Format	Binary Bytes	Binary Offset
11	Reserved1		Double	8	H+60
12	Reserved2		Double	8	H+68
13	Next satellite offset = H+4+(#sat x 72)				
14	xxxx	32-bit CRC (ASCII and Binary only)	Ulong	4	H+4+ (#sat x 72)
15	[CR][LF]	Sentence terminator (ASCII only)			

3.157 SAVESURVEYPOSITIONS

Saved surveyed positions

Platform: OEM719, OEM729, OEM7500, OEM7600, OEM7700, OEM7720, PwrPak7, SPAN CPT7, SMART7

This log lists the surveyed positions saved on the receiver.

A surveyed position is saved using the **AUTOSURVEY** command (see page 66) or **SURVEYPOSITION** command (see page 298).

Message ID: 1951

Log Type: Polled

Recommended Input:

```
log savedsurveypositions once
```

Abbreviated ASCII Example:

```
<SAVESURVEYPOSITIONS COM1 0 82.5 FINESTEERING 2003 313938.731 02000008 ddf2
32768
<      3
<      "MN01" 51.000000000000 100.000000000000 150.0000
<      "TST1" 90.000000000000 90.000000000000 90.0000
<      "MON1" 45.000000000000 45.000000000000 45.0000
```

Field	Field Type	Description	Format	Binary Bytes	Binary Offset
1	SAVESURVEY POSITIONS header	Log header. See <i>Messages</i> on page 27 for more information.		H	0
2	#Positions	Number of records to follow.	Ulong	4	H
3	Position ID	ID for the saved position. Note: In the Binary case, the ID string must be null terminated and additional bytes of padding must be added to make the total length of the field 8 bytes.	String	8	H+4
4	Latitude	Latitude of the position (-90 to 90 degrees) where a '-' sign denotes south and a '+' sign denotes north	Double	8	H+12
5	Longitude	Longitude of the position (-360 to 360 degrees) where a '-' sign denotes west and a '+' sign denotes east	Double	8	H+20

Field	Field Type	Description	Format	Binary Bytes	Binary Offset
6	Height	Mean Sea Level height of the position in meters	Double	8	H+28
7	Next reading offset = $H+4+(\#Positions * 32)$				
8	xxxx	32-bit CRC (ASCII and Binary only)	Hex	4	H+4+ (#Positions * 32)
9	[CR][LF]	Sentence terminator (ASCII only)	-	-	-

3.158 SBAS0

Do not use for safety applications

Platform: OEM719, OEM729, OEM7500, OEM7600, OEM7700, OEM7720, PwrPak7, SPAN CPT7, SMART7, SMART2

This message specifies the PRN if GEO transmitting SBAS corrections is operating in test mode, and should not be used for safety applications for a period of time outlined in the SBAS signal specification.



The GEO transmitting SBAS corrections is operating in test mode, and should not be used for safety-of-life applications.

See how the SBAS0 message relates to the SBAS testing modes in the **SBASCONTROL** command on page 265.

Message ID: 976

Log Type: Asynch

Recommended Input:

```
log SBAS0a onchanged
```

ASCII Example:

```
#SBAS0A,COM1,0,72.5,SATTIME,2073,327283.000,1a000000,5a84,15761;130*8390deb3
```



Although the SBAS was designed for aviation users, it supports a wide variety of non-aviation uses including agriculture, surveying, recreation, and surface transportation.

Field	Field type	Description	Format	Binary Bytes	Binary Offset
1	SBAS0 header	Log header. See <i>Messages</i> on page 27 for more information.		H	0
2	prn	Source PRN message - also PRN not to use	Ulong	4	H
3	xxxx	32-bit CRC (ASCII and Binary only)	Ulong	4	H+4
4	[CR][LF]	Sentence terminator (ASCII only)	-	-	-

3.160 SBAS2

Fast correction slots 0-12

Platform: OEM719, OEM729, OEM7500, OEM7600, OEM7700, OEM7720, PwrPak7, SPAN CPT7, SMART7, SMART2

SBAS2 are fast corrections for slots 0-12 in the mask of SBAS1. This message may or may not come when SBAS is in testing mode (see the **SBASCONTROL** command on page 265 for details).

Message ID: 982

Log Type: Asynch

Recommended Input:

```
log SBAS2a onchanged
```

ASCII Example:

```
#SBAS2A,COM1,0,29.0,SATTIME,1337,415925.000,02000000,e194,1984;134,2,2,3,-3,5,
1,2047,-2,2047,2047,2047,2047,2047,-3,2,5,11,7,8,14,8,14,14,14,14,14,6,12
*8d8d2e1c
```



Each raw SBAS frame gives data for a specific frame decoder number. The SBAS2 message can be logged to view the data breakdown of SBAS frame 2 which contains information about fast correction slots 0-12.

Field	Field type	Description	Format	Binary Bytes	Binary Offset
1	SBAS2 header	Log header. See <i>Messages</i> on page 27 for more information.		H	0
2	prn	Source PRN of message	Ulong	4	H
3	iodf	Issue of fast corrections data	Ulong	4	H+4
4	iodp	Issue of PRN mask data	Ulong	4	H+8

Field	Field type	Description	Format	Binary Bytes	Binary Offset
5	prc0	prc(i): Fast corrections (-2048 to +2047) for the PRN in slot i (i = 0-12)	Long	4	H+12
6	prc1		Long	4	H+16
7	prc2		Long	4	H+20
8	prc3		Long	4	H+24
9	prc4		Long	4	H+28
10	prc5		Long	4	H+32
11	prc6		Long	4	H+36
12	prc7		Long	4	H+40
13	prc8		Long	4	H+44
14	prc9		Long	4	H+48
15	prc10		Long	4	H+52
16	prc11		Long	4	H+56
17	prc12		Long	4	H+60
18	udre0	udre(i): User differential range error indicator for the PRN in slot i (i = 0-12) <i>See Table 168: Evaluation of UDREI on the next page for scaling information.</i>	Ulong	4	H+64
19	udre1		Ulong	4	H+68
20	udre2		Ulong	4	H+72
21	udre3		Ulong	4	H+76
22	udre4		Ulong	4	H+80
23	udre5		Ulong	4	H+84
24	udre6		Ulong	4	H+88
25	udre7		Ulong	4	H+92
26	udre8		Ulong	4	H+96
27	udre9		Ulong	4	H+100
28	udre10		Ulong	4	H+104
29	udre11		Ulong	4	H+108
30	udre12		Ulong	4	H+112
31	xxxx	32-bit CRC (ASCII and Binary only)	Ulong	4	H+116
32	[CR] [LF]	Sentence terminator (ASCII only)	-	-	-

Table 168: Evaluation of UDREI

UDREI 1	UDRE meters	$\sigma^2_{i.udre}$ meters²
0	0.75	0.0520
1	1.0	0.0924
2	1.25	0.1444
3	1.75	0.2830
4	2.25	0.4678
5	3.0	0.8315
6	3.75	1.2992
7	4.5	1.8709
8	5.25	2.5465
9	6.0	3.3260
10	7.5	5.1968
11	15.0	20.7870
12	50.0	230.9661
13	150.0	2078.695
14	Not Monitored	Not Monitored
15	Do Not Use	Do Not Use

1The s2UDRE broadcast in SBAS2, SBAS3, SBAS4, SBAS5, SBAS6 and SBAS24 applies at a time prior to or at the time of applicability of the associated corrections.

3.161 SBAS3

Fast corrections slots 13-25

Platform: OEM719, OEM729, OEM7500, OEM7600, OEM7700, OEM7720, PwrPak7, SPAN CPT7, SMART7, SMART2

SBAS3 are fast corrections for slots 13-25 in the mask of SBAS1.

Message ID: 987

Log Type: Asynch

Recommended Input:

```
log SBAS3a onchanged
```

ASCII Example:

```
#SBAS3A,COM1,0,17.0,SATTIME,1337,415990.000,02000000,bff5,1984;134,1,2,2047,0,
2047,2047,-21,-4,2047,2047,-1,0,2,2047,6,14,5,14,14,11,5,14,14,5,7,5,14,8
*a25aebc5
```



Each raw SBAS frame gives data for a specific frame decoder number. The SBAS3 message can be logged to view the data breakdown of SBAS frame 3 which contains information about fast correction slots 13-25.

Field	Field type	Description	Format	Binary Bytes	Binary Offset
1	SBAS3 header	Log header. See <i>Messages</i> on page 27 for more information.		H	0
2	prn	Source PRN of message	Ulong	4	H
3	iodf	Issue of fast corrections data	Ulong	4	H+4
4	iodp	Issue of PRN mask data	Ulong	4	H+8

Field	Field type	Description	Format	Binary Bytes	Binary Offset
5	prc13	prc(i): Fast corrections (-2048 to +2047) for the PRN in slot i (i = 13-25)	Long	4	H+12
6	prc14		Long	4	H+16
7	prc15		Long	4	H+20
8	prc16		Long	4	H+24
9	prc17		Long	4	H+28
10	prc18		Long	4	H+32
11	prc19		Long	4	H+36
12	prc20		Long	4	H+40
13	prc21		Long	4	H+44
14	prc22		Long	4	H+48
15	prc23		Long	4	H+52
16	prc24		Long	4	H+56
17	prc25		Long	4	H+60
18	udre13	udre(i): User differential range error indicator for the PRN in slot i (i = 13-25) See <i>Table 168: Evaluation of UDREI</i> on page 724 for scaling information.	Ulong	4	H+64
19	udre14		Ulong	4	H+68
20	udre15		Ulong	4	H+72
21	udre16		Ulong	4	H+76
22	udre17		Ulong	4	H+80
23	udre18		Ulong	4	H+84
24	udre19		Ulong	4	H+88
25	udre20		Ulong	4	H+92
26	udre21		Ulong	4	H+96
27	udre22		Ulong	4	H+100
28	udre23		Ulong	4	H+104
29	udre24		Ulong	4	H+108
30	udre25		Ulong	4	H+112
31	xxxx	32-bit CRC (ASCII and Binary only)	Ulong	4	H+116
32	[CR][LF]	Sentence terminator (ASCII only)	-	-	-

3.162 SBAS4

Fast correction slots 26-38

Platform: OEM719, OEM729, OEM7500, OEM7600, OEM7700, OEM7720, PwrPak7, SPAN CPT7, SMART7, SMART2

SBAS4 are fast corrections for slots 26-38 in the mask of SBAS1.

Message ID: 992

Log Type: Asynch

Recommended Input:

```
log SBAS4a onchanged
```

ASCII Example:

```
#SBAS4A,COM1,0,58.0,SATTIME,1093,163399.000,02000020,b4b0,209;122,0,3,2047,3,-1,2047,2047,2047,-3,-1,5,3,3,2047,2,14,3,3,14,14,14,6,3,4,5,4,14,3*2e0894b1
```



Each raw SBAS frame gives data for a specific frame decoder number. The SBAS4 message can be logged to view the data breakdown of SBAS frame 4 which contains information about fast correction slots 26-38.

Field	Field type	Description	Format	Binary Bytes	Binary Offset
1	SBAS4 header	Log header. See <i>Messages</i> on page 27 for more information.		H	0
2	prn	Source PRN of message	Ulong	4	H
3	iodf	Issue of fast corrections data	Ulong	4	H+4
4	iodp	Issue of PRN mask data	Ulong	4	H+8

Field	Field type	Description	Format	Binary Bytes	Binary Offset
5	prc26	prc(i): Fast corrections (-2048 to +2047) for the PRN in slot i (i = 26-38)	Long	4	H+12
6	prc27		Long	4	H+16
7	prc28		Long	4	H+20
8	prc29		Long	4	H+24
9	prc30		Long	4	H+28
10	prc31		Long	4	H+32
11	prc32		Long	4	H+36
12	prc33		Long	4	H+40
13	prc34		Long	4	H+44
14	prc35		Long	4	H+48
15	prc36		Long	4	H+52
16	prc37		Long	4	H+56
17	prc38		Long	4	H+60
18	udre26	udre(i): User differential range error indicator for the PRN in slot i (i = 26-38) See <i>Table 168: Evaluation of UDREI</i> on page 724 for scaling information.	Ulong	4	H+64
19	udre27		Ulong	4	H+68
20	udre28		Ulong	4	H+72
21	udre29		Ulong	4	H+76
22	udre30		Ulong	4	H+80
23	udre31		Ulong	4	H+84
24	udre32		Ulong	4	H+88
25	udre33		Ulong	4	H+92
26	udre34		Ulong	4	H+96
27	udre35		Ulong	4	H+100
28	udre36		Ulong	4	H+104
29	udre37		Ulong	4	H+108
30	udre38	Ulong	4	H+112	
31	xxxx	32-bit CRC (ASCII and Binary only)	Ulong	4	H+116
32	[CR][LF]	Sentence terminator (ASCII only)	-	-	-

3.163 SBAS5

Fast correction slots 39-50

Platform: OEM719, OEM729, OEM7500, OEM7600, OEM7700, OEM7720, PwrPak7, SPAN CPT7, SMART7, SMART2

SBAS5 are fast corrections for slots 39-50 in the mask of SBAS1.

Message ID: 994

Log Type: Asynch

Recommended Input:

```
log SBAS5a onchanged
```

ASCII Example:

```
#SBAS5A,COM1,0,72.5,SATTIME,1093,161480.000,02040020,31d4,209;122,1,3,-7,2047,
2047,2047,-4,2047,2047,2047,9,2047,2047,-3,-2,11,14,14,14,4,14,14,14,5,14,14,4,
2*2bf0109b
```



Each raw SBAS frame gives data for a specific frame decoder number. The SBAS5 message can be logged to view the data breakdown of SBAS frame 5 which contains information about fast correction slots 39-50.

Field	Field type	Description	Format	Binary Bytes	Binary Offset
1	SBAS5 header	Log header. See <i>Messages</i> on page 27 for more information.		H	0
2	prn	Source PRN of message	Ulong	4	H
3	iodf	Issue of fast corrections data	Ulong	4	H+4
4	iodp	Issue of PRN mask data	Ulong	4	H+8

Field	Field type	Description	Format	Binary Bytes	Binary Offset
5	prc39	prc(i): Fast corrections (-2048 to +2047) for the PRN in slot i (i = 39-50)	Long	4	H+12
6	prc40		Long	4	H+16
7	prc41		Long	4	H+20
8	prc42		Long	4	H+24
9	prc43		Long	4	H+28
10	prc44		Long	4	H+32
11	prc45		Long	4	H+36
12	prc46		Long	4	H+40
13	prc47		Long	4	H+44
14	prc48		Long	4	H+48
15	prc49		Long	4	H+52
16	prc50		Long	4	H+56
17	prc51 (Invalid, do not use)		Long	4	H+60
18	udre39	udre(i): User differential range error indicator for the PRN in slot i (i = 39-50) <i>See Table 168: Evaluation of UDREI on page 724 for scaling information.</i>	Ulong	4	H+64
19	udre40		Ulong	4	H+68
20	udre41		Ulong	4	H+72
21	udre42		Ulong	4	H+76
22	udre43		Ulong	4	H+80
23	udre44		Ulong	4	H+84
24	udre45		Ulong	4	H+88
25	udre46		Ulong	4	H+92
26	udre47		Ulong	4	H+96
27	udre48		Ulong	4	H+100
28	udre49		Ulong	4	H+104
29	udre50		Ulong	4	H+108
30	udre51 (Invalid, do not use)		Ulong	4	H+112
31	xxxx	32-bit CRC (ASCII and Binary only)	Ulong	4	H+116
32	[CR][LF]	Sentence terminator (ASCII only)	-	-	-

3.164 SBAS6

Integrity message

Platform: OEM719, OEM729, OEM7500, OEM7600, OEM7700, OEM7720, PwrPak7, SPAN CPT7, SMART7, SMART2

SBAS6 is the integrity information message. Each message includes an IODF for each fast corrections message. The σ^2_{UDRE} information for each block of satellites applies to the fast corrections with the corresponding IODF.

Message ID: 995

Log Type: Asynch

Recommended Input:

```
log SBAS6a onchanged
```

ASCII Example:

```
#SBAS6A,COM1,0,57.5,SATTIME,1093,273317.000,02000020,526a,209;122,3,3,3,3,9,14,14,2,3,10,2,14,14,3,14,14,5,14,14,7,14,14,14,14,14,14,3,3,14,14,14,14,3,15,11,11,15,0,0,0,0,0,0,0,0,0,0,0,0,0,0,0,0,0,0,0,0,0*925a2a9b
```



Each raw SBAS frame gives data for a specific frame decoder number. The SBAS6 message can be logged to view the data breakdown of SBAS frame 6 which contains information about the integrity message.

Field	Field type	Description	Format	Binary Bytes	Binary Offset
1	SBAS6 header	Log header. See <i>Messages</i> on page 27 for more information.		H	0
2	prn	Source PRN of message	Ulong	4	H
3	iodf2	Issue of fast corrections data	Ulong	4	H+4
4	iodf3	Issue of fast corrections data	Ulong	4	H+8
5	iodf4	Issue of fast corrections data	Ulong	4	H+12
6	iodf5	Issue of fast corrections data	Ulong	4	H+16
7	udre0	udre(i): User differential range error indicator for the PRN in slot i (i = 0-50) See <i>Table 168: Evaluation of UDREI</i> on page 724 for scaling information.	Ulong	4	H+20
8	udre1		Ulong	4	H+24
9	udre2		Ulong	4	H+28

Field	Field type	Description	Format	Binary Bytes	Binary Offset
10	udre3		Ulong	4	H+32
11	udre4		Ulong	4	H+36
12	udre5		Ulong	4	H+40
13	udre6		Ulong	4	H+44
14	udre7		Ulong	4	H+48
15	udre8		Ulong	4	H+52
16	udre9		Ulong	4	H+56
17	udre10		Ulong	4	H+60
18	udre11		Ulong	4	H+64
19	udre12		Ulong	4	H+68
20	udre13		Ulong	4	H+72
21	udre14		Ulong	4	H+76
22	udre15		Ulong	4	H+80
23	udre16		Ulong	4	H+84
24	udre17		Ulong	4	H+88
25	udre18		Ulong	4	H+92
26	udre19		Ulong	4	H+96
27	udre20		Ulong	4	H+100
28	udre21		Ulong	4	H+104
29	udre22		Ulong	4	H+108
30	udre23		Ulong	4	H+112
31	udre24		Ulong	4	H+116
32	udre25		Ulong	4	H+120
33	udre26		Ulong	4	H+124
34	udre27		Ulong	4	H+128
35	udre28		Ulong	4	H+132
36	udre29		Ulong	4	H+136
37	udre30		Ulong	4	H+140

Field	Field type	Description	Format	Binary Bytes	Binary Offset
38	udre31		Ulong	4	H+144
39	udre32		Ulong	4	H+148
40	udre33		Ulong	4	H+152
41	udre34		Ulong	4	H+156
42	udre35		Ulong	4	H+160
43	udre36		Ulong	4	H+164
44	udre37		Ulong	4	H+168
45	udre38		Ulong	4	H+172
46	udre39		Ulong	4	H+176
47	udre40		Ulong	4	H+180
48	udre41		Ulong	4	H+184
49	udre42		Ulong	4	H+188
50	udre43		Ulong	4	H+192
51	udre44		Ulong	4	H+196
52	udre45		Ulong	4	H+200
53	udre46		Ulong	4	H+204
54	udre47		Ulong	4	H+208
55	udre48		Ulong	4	H+212
56	udre49		Ulong	4	H+216
58	udre50		Ulong	4	H+220
58	udre51 (Invalid, do not use)		Ulong	4	H+224
59	xxxx	32-bit CRC (ASCII and Binary only)	Ulong	4	H+228
60	[CR][LF]	Sentence terminator (ASCII only)	-	-	-

3.165 SBAS7

Fast correction degradation

Platform: OEM719, OEM729, OEM7500, OEM7600, OEM7700, OEM7720, PwrPak7, SPAN CPT7, SMART7, SMART2

The SBAS7 message specifies the applicable IODP, system latency time and fast degradation factor indicator for computing the degradation of fast and long term corrections.

Message ID: 996

Log Type: Asynch

Recommended Input:

```
log SBAS7a onchanged
```

ASCII Example:

```
#SBAS7A,COM1,0,36.5,SATTIME,1337,416367.000,02000000,12e3,1984;122,1,2,0,15,15,
15,15,15,15,15,15,15,15,15,15,15,15,15,15,15,15,15,15,15,15,15,15,15,15,1
5,15,15,15,0,0,0,0,0,0,0,0,0,0,0,0,0,0,0,0,0,0,0,0,0*827a7364
```



Each raw SBAS frame gives data for a specific frame decoder number. The SBAS7 message can be logged to view the data breakdown of SBAS frame 7 which contains information about fast correction degradation.

Field	Field type	Description	Format	Binary Bytes	Binary Offset
1	SBAS7 header	Log header. See <i>Messages</i> on page 27 for more information.		H	0
2	prn	Source PRN of message	Ulong	4	H
3	latency	System latency (s)	Ulong	4	H+4
4	iodp	Issue of PRN mask data	Ulong	4	H+8
5	spare bits	Unused spare bits	Ulong	4	H+12
6	aI(0)	aI(i): Degradation factor indicator for the PRN in slot i (i = 0-50)	Ulong	4	H+16
7	aI(1)		Ulong	4	H+20
8	aI(2)		Ulong	4	H+24
9	aI(3)		Ulong	4	H+28
10	aI(4)		Ulong	4	H+32
11	aI(5)		Ulong	4	H+36

Field	Field type	Description	Format	Binary Bytes	Binary Offset
12	aI(6)		Ulong	4	H+40
13	aI(7)		Ulong	4	H+44
14	aI(8)		Ulong	4	H+48
15	aI(9)		Ulong	4	H+52
16	aI(10)		Ulong	4	H+56
17	aI(11)		Ulong	4	H+60
18	aI(12)		Ulong	4	H+64
19	aI(13)		Ulong	4	H+68
20	aI(14)		Ulong	4	H+72
21	aI(15)		Ulong	4	H+76
22	aI(16)		Ulong	4	H+80
23	aI(17)		Ulong	4	H+84
24	aI(18)		Ulong	4	H+88
25	aI(19)		Ulong	4	H+92
26	aI(20)		Ulong	4	H+96
27	aI(21)		Ulong	4	H+100
28	aI(22)		Ulong	4	H+104
29	aI(23)		Ulong	4	H+108
30	aI(24)		Ulong	4	H+112
31	aI(25)		Ulong	4	H+116
32	aI(26)		Ulong	4	H+120
33	aI(27)		Ulong	4	H+124
34	aI(28)		Ulong	4	H+128
35	aI(29)		Ulong	4	H+132
36	aI(30)		Ulong	4	H+136
37	aI(31)		Ulong	4	H+140
38	aI(32)		Ulong	4	H+144
39	aI(33)		Ulong	4	H+148

Field	Field type	Description	Format	Binary Bytes	Binary Offset
40	aI(34)		Ulong	4	H+152
41	aI(35)		Ulong	4	H+156
42	aI(36)		Ulong	4	H+160
43	aI(37)		Ulong	4	H+164
44	aI(38)		Ulong	4	H+168
45	aI(39)		Ulong	4	H+172
46	aI(40)		Ulong	4	H+176
47	aI(41)		Ulong	4	H+180
48	aI(42)		Ulong	4	H+184
49	aI(43)		Ulong	4	H+188
50	aI(44)		Ulong	4	H+192
51	aI(45)		Ulong	4	H+196
52	aI(46)		Ulong	4	H+200
53	aI(47)		Ulong	4	H+204
54	aI(48)		Ulong	4	H+208
55	aI(49)		Ulong	4	H+212
56	aI(50)		Ulong	4	H+216
57	aI(51) (Invalid, do not use)		Ulong	4	H+220
58	xxxx	32-bit CRC (ASCII and Binary only)	Ulong	4	H+224
59	[CR][LF]	Sentence terminator (ASCII only)	-	-	-

3.166 SBAS9

GEO navigation message

Platform: OEM719, OEM729, OEM7500, OEM7600, OEM7700, OEM7720, PwrPak7, SPAN CPT7, SMART7, SMART2

SBAS9 provides the GEO navigation message representing the position, velocity and acceleration of the geostationary satellite, in ECEF coordinates and its apparent clock time and frequency offsets.

Also included is the time of applicability, an Issue of Data (IOD) and an accuracy exponent (URA) representing the estimated accuracy of the message. The time offset and time drift are with respect to SBAS Network Time. Their combined effect is added to the estimate of the satellite's transmit time.

Message ID: 997

Log Type: Asynch

Recommended Input:

```
log SBAS9a onchanged
```

ASCII Example:

```
#SBAS9A, COM1, 0, 38.0, SATTIME, 1337, 416426.000, 02000000, b580, 1984; 122, 175, 70848, 2, 24802064.1600, -34087313.9200, -33823.2000, 1.591250000, 0.107500000, 0.6080000, -0.0000750, -0.0001125, 0.000187500, -2.235174179e-08, 9.094947018e-12*636051d2
```



Each raw SBAS frame gives data for a specific frame decoder number. The SBAS9 message can be logged to view the data breakdown of SBAS frame 9 which contains the GEO navigation message.

Field	Field type	Description	Format	Binary Bytes	Binary Offset
1	SBAS9 header	Log header. See <i>Messages</i> on page 27 for more information.		H	0
2	prn	Source PRN of message	Ulong	4	H
3	iodn	Issue of GEO navigation data	Ulong	4	H+4
4	t_0	Time of applicability	Ulong	4	H+8
5	ura	URA value	Ulong	4	H+12
6	x	ECEF x coordinate (m)	Double	8	H+16
7	y	ECEF y coordinate (m)	Double	8	H+24
8	z	ECEF z coordinate (m)	Double	8	H+32
9	xvel	X rate of change (m/s)	Double	8	H+40

Field	Field type	Description	Format	Binary Bytes	Binary Offset
10	yvel	Y rate of change (m/s)	Double	8	H+48
11	zvel	Z rate of change (m/s)	Double	8	H+56
12	xaccel	X rate of rate change (m/s ²)	Double	8	H+64
13	yaccel	Y rate of rate change (m/s ²)	Double	8	H+72
14	zaccel	Z rate of rate change (m/s ²)	Double	8	H+80
15	a _{f0}	Time offset (s)	Double	8	H+88
16	a _{f1}	Time drift (s)	Double	8	H+96
17	xxxx	32-bit CRC (ASCII and Binary only)	Ulong	4	H+104
18	[CR][LF]	Sentence terminator (ASCII only)	-	-	-

3.167 SBAS10

Degradation factor

Platform: OEM719, OEM729, OEM7500, OEM7600, OEM7700, OEM7720, PwrPak7, SPAN CPT7, SMART7, SMART2

The fast corrections, long term corrections and ionospheric corrections are all provided in the SBAS10 message.

Message ID: 978

Log Type: Asynch

Recommended Input:

```
log SBAS10a onchanged
```

ASCII Example:

```
#SBAS10A,COM1,0,35.5,SATTIME,1337,416469.000,02000000,c305,1984;122,54,38,76,256,152,100,311,83,256,6,0,300,292,0,1,000000000000000000000000*8884d248
```



Each raw SBAS frame gives data for a specific frame decoder number. The SBAS10 message can be logged to view the data breakdown of SBAS frame 10 which contains information about degradation factors.

Field	Field type	Description	Format	Binary Bytes	Binary Offset	Scaling
1	SBAS10 header	Log header. See <i>Messages</i> on page 27 for more information.		H	0	-
2	prn	Source PRN of message	Ulong	4	H	-
3	b _{rcc}	Estimated noise and round off error parameter	Ulong	4	H+4	0.002
4	c _{lrc_lsb}	Maximum round off due to the least significant bit (lsb) of the orbital clock	Ulong	4	H+8	0.002
5	c _{lrc_vl}	Velocity error bound	Ulong	4	H+12	0.00005
6	i _{lrc_vl}	Update interval for v=1 long term	Ulong	4	H+16	-
7	c _{lrc_v0}	Bound on update delta	Ulong	4	H+20	0.002
8	i _{lrc_v1}	Minimum update interval v = 0	Ulong	4	H+24	-
9	c _{geo_lsb}	Maximum round off due to the lsb of the orbital clock	Ulong	4	H+28	0.0005
10	c _{geo_v}	Velocity error bound	Ulong	4	H+32	0.00005

Field	Field type	Description	Format	Binary Bytes	Binary Offset	Scaling
11	i _{geo}	Update interval for GEO navigation message	Ulong	4	H+36	-
12	c _{er}	Degradation parameter	Ulong	4	H+40	0.5
13	c _{iono_step}	Bound on ionospheric grid delay difference	Ulong	4	H+44	0.001
14	i _{iono}	Minimum ionospheric update interval	Ulong	4	H+48	-
15	c _{iono_ramp}	Rate of ionospheric corrections change	Ulong	4	H+52	0.000005
16	rss _{udre}	User differential range error flag	Ulong	4	H+56	-
17	rss _{iono}	Root sum square flag	Ulong	4	H+60	-
18	spare bits	Spare 88 bits, possibly GLONASS	Hex[11]	11	H+64	-
19	xxxx	32-bit CRC (ASCII and Binary only)	Ulong	4	H+75	-
20	[CR] [LF]	Sentence terminator (ASCII only)	-	-	-	-

3.168 SBAS12

SBAS network time and UTC

Platform: OEM719, OEM729, OEM7500, OEM7600, OEM7700, OEM7720, PwrPak7, SPAN CPT7, SMART7, SMART2

SBAS12 contains information bits for the UTC parameters and UTC time standard from which an offset is determined. The UTC parameters correlate UTC time with the SBAS network time rather than with GPS reference time.

Message ID: 979

Log Type: Asynch

Recommended Input:

```
log SBAS12a onchanged
```



Each raw SBAS frame gives data for a specific frame decoder number. The SBAS12 message can be logged to view the data breakdown of SBAS frame 12 which contains information about time parameters.

Field	Field type	Description	Format	Binary Bytes	Binary Offset
1	SBAS12 header	Log header. See <i>Messages</i> on page 27 for more information.		H	0
2	prn	Source PRN of message	Ulong	4	H
3	A_1	Time drift (s/s)	Double	8	H+4
4	A_0	Time offset (s)	Double	8	H+12
5	seconds	Seconds into the week (s)	Ulong	4	H+20
6	week	Week number	Ushort	2	H+24
7	dt_{ls}	Delta time due to leap seconds	Short	2	H+26
8	wn_{lsf}	Week number, leap second future	Ushort	2	H+28
9	dn	Day of the week (the range is 1 to 7 where Sunday = 1 and Saturday = 7)	Ushort	2	H+30
10	dt_{lsf}	Delta time, leap second future	Ushort	2	H+32
11	utc id	UTC type identifier	Ushort	2	H+34
12	gpstow	GPS reference time of the week	Ulong	4	H+36
13	gpswn	GPS de-modulo week number	Ulong	4	H+40

Field	Field type	Description	Format	Binary Bytes	Binary Offset
14	glo indicator	Is GLONASS information present? 0 = FALSE 1 = TRUE	Enum	4	H+44
15	Reserved array of hexabytes for GLONASS		Char [10]	12 ¹	H+48
16	xxxx	32-bit CRC (ASCII and Binary only)	Ulong	4	H+60
17	[CR][LF]	Sentence terminator (ASCII only)	-	-	-

¹In the binary log case, an additional 2 bytes of padding are added to maintain 4-byte alignment.

3.169 SBAS17

GEO Almanac message

Platform: OEM719, OEM729, OEM7500, OEM7600, OEM7700, OEM7720, PwrPak7, SPAN CPT7, SMART7, SMART2

Almanacs for all GEOs are broadcast periodically to alert you of their existence, location, the general service provided, status and health.



Unused almanacs have a PRN number of 0 and should be ignored, see *ASCII Example* below.

Message ID: 980

Log Type: Asynch

Recommended Input:

```
log SBAS17a onchanged
```

ASCII Example:

```
#SBAS17A, COM1, 0, 84.5, SATTIME, 1610, 514149.000, 02000000, 896c, 39061;135, 3, 0, 135,
0, -11536200, -40536600, -260000, 0, 0, 0, 0, 138, 0, -12521600, -40258400,
0, 0, 0, 0, 0, 133, 0, -5551000, -41774200, -1248000, 0, 0, 120, 82112*2be5146f
```



Each raw SBAS frame gives data for a specific frame decoder number. The SBAS17 message can be logged to view the data breakdown of SBAS frame 17 which contains GEO almanacs.

Field	Field type	Description	Format	Binary Bytes	Binary Offset
1	SBAS17 header	Log header. See <i>Messages</i> on page 27 for more information.		H	0
2	prn	Source PRN of message	Ulong	4	H
3	#ents	Number of almanac entries with information to follow	Ulong	4	H+4
4	data id	Data ID type	Ushort	2	H+8
5	entry prn	PRN for this entry	Ushort	2	H+10
6	health	Health bits	Ushort	4 ¹	H+12
7	x	ECEF x coordinate (m)	Long	4	H+16

¹In the binary log case, an additional 2 bytes of padding is added to maintain 4-byte alignment.

Field	Field type	Description	Format	Binary Bytes	Binary Offset
8	y	ECEF y coordinate (m)	Long	4	H+20
9	z	ECEF z coordinate (m)	Long	4	H+24
10	x vel	X rate of change (m/s)	Long	4	H+28
11	y vel	Y rate of change (m/s)	Long	4	H+32
12	z vel	Z rate of change (m/s)	Long	4	H+36
13...	Next entry = H+8+(#ents x 32)				
14	t0	Time of day in seconds (0 to 86336) Scaling = 64	Ulong	4	H+8+ (#ents x 32)
15	xxxx	32-bit CRC (ASCII and Binary only)	Ulong	4	H+12+ (#ents x 32)
16	[CR][LF]	Sentence terminator (ASCII only)	-	-	-

3.170 SBAS18

IGP mask

Platform: OEM719, OEM729, OEM7500, OEM7600, OEM7700, OEM7720, PwrPak7, SPAN CPT7, SMART7, SMART2

The ionospheric delay corrections are broadcast as vertical delay estimates, at specified ionospheric grid points (IGPs), applicable to a signal on L1. The predefined IGPs are contained in 11 bands (numbered 0 to 10). Bands 0-8 are vertical bands on a Mercator projection map and bands 9-10 are horizontal bands on a Mercator projection map. Since it is impossible to broadcast IGP delays for all possible locations, a mask is broadcast to define the IGP locations providing the most efficient model of the ionosphere at the time.

Message ID: 981

Log Type: Asynch

Recommended Input:

```
log SBAS18a onchanged
```

ASCII Example:

```
#SBAS18A,COM1,0,33.0,SATTIME,1337,417074.000,02000000,f2c0,1984;122,4,2,2,0000f
fc0007fc0003ff0000ff80007fe0007fe0003ff0000ff80,0*b1ed353e
```



Each raw SBAS frame gives data for a specific frame decoder number. The SBAS18 message can be logged to view the data breakdown of SBAS frame 18 which contains information about ionospheric grid points.

Field	Field type	Description	Format	Binary Bytes	Binary Offset
1	SBAS18 header	Log header. See <i>Messages</i> on page 27 for more information.		H	0
2	prn	Source PRN of message	Ulong	4	H
3	#bands	Number of bands broadcast	Ulong	4	H+4
4	band num	Specific band number that identifies which of the 11 IGP bands the data belongs to	Ulong	4	H+8
5	iodi	Issue of ionospheric data	Ulong	4	H+12
6	igp mask	IGP mask	Uchar [26]	28 ¹	H+16
7	spare bit	One spare bit	Ulong	4	H+44

¹In the binary log case, an additional 2 bytes of padding are added to maintain 4-byte alignment.

Field	Field type	Description	Format	Binary Bytes	Binary Offset
8	xxxx	32-bit CRC (ASCII and Binary only)	Ulong	4	H+48
9	[CR][LF]	Sentence terminator (ASCII only)	-	-	-

Field	Field type	Description	Format	Binary Bytes	Binary Offset	Scaling
3	prc0	prc(i): Fast corrections (-2048 to +2047) for the PRN in slot i (i = 0-5)	Long	4	H+4	-
4	prc1		Long	4	H+8	-
5	prc2		Long	4	H+12	-
6	prc3		Long	4	H+16	-
7	prc4		Long	4	H+20	-
8	prc5		Long	4	H+24	-
9	udre0	udre(i): User differential range error indicator for the PRN in slot i (i = 0-5)	Ulong	4	H+28	See Table 168: Evaluation of UDREI on page 724
10	udre1		Ulong	4	H+32	
11	udre2		Ulong	4	H+36	
12	udre3		Ulong	4	H+40	
13	udre4		Ulong	4	H+44	
14	udre5		Ulong	4	H+48	
15	iodp	Issue of PRN mask data	Ulong	4	H+52	-
16	block id	Associated message type	Ulong	4	H+56	
17	iodf	Issue of fast corrections data	Ulong	4	H+60	-
18	spare	Spare value	Ulong	4	H+64	-
19	vel	Velocity code flag	Ulong	4	H+68	-
20	mask1	Index into PRN mask (Type 1)	Ulong	4	H+72	-
21	iode1	Issue of ephemeris data	Ulong	4	H+76	-
22	dx1	Delta x (ECEF)	Long	4	H+80	0.125
23	dy1	Delta y (ECEF)	Long	4	H+84	0.125
24	dz1	Delta z (ECEF)	Long	4	H+88	0.125
25	da _{f0}	Delta a _{f0} clock offset	Long	4	H+92	2 ⁻³¹
26	mask2	Second index into PRN mask (Type 1)	Ulong	4	H+96	-
27	iode2	Second issue of ephemeris data	Ulong	4	H+100	-
28	ddx	Delta delta x (ECEF)	Long	4	H+104	2 ⁻¹¹

Field	Field type	Description	Format	Binary Bytes	Binary Offset	Scaling
29	ddy	Delta delta y (ECEF)	Long	4	H+108	2 ⁻¹¹
30	ddz	Delta delta z (ECEF)	Long	4	H+112	2 ⁻¹¹
31	da _{f1}	Delta a _{f1} clock offset	Long	4	H+116	2 ⁻³⁹
32	t ₀	Applicable time of day	Ulong	4	H+120	16
33	iodp	Issue of PRN mask data	Ulong	4	H+124	-
34	corr spare	Spare value when velocity code is equal to 0	Ulong	4	H+128	-
35	xxxx	32-bit CRC (ASCII and Binary only)	Ulong	4	H+132	-
36	[CR] [LF]	Sentence terminator (ASCII only)	-	-	-	-

3.172 SBAS25

Long term slow satellite corrections

Platform: OEM719, OEM729, OEM7500, OEM7600, OEM7700, OEM7720, PwrPak7, SPAN CPT7, SMART7, SMART2

SBAS25 provides error estimates for slow varying satellite ephemeris and clock errors with respect to WGS-84 ECEF coordinates.

Message ID: 984

Log Type: Asynch

Recommended Input:

```
log SBAS25a onchanged
```

ASCII Example:

```
#SBAS25A,COM1,0,37.5,SATTIME,1337,417193.000,02000000,b8ff,1984;134,1,19,25,-1,-3,0,-15,0,0,0,1,-1,-2,4465,2,0,1,0,0,0,0,0,0,0,0,0,0,0,0,0*81685317
```



Each raw SBAS frame gives data for a specific frame decoder number. The SBAS25 message can be logged to view the data breakdown of SBAS frame 25 which contains long term slow satellite corrections.

Field	Field type	Description	Format	Binary Bytes	Binary Offset	Scaling
1	SBAS25 header	Log header. See <i>Messages</i> on page 27 for more information.		H	0	-
2	prn	Source PRN of message	Ulong	4	H	-
3	1st half vel	Velocity code flag (0 or 1)	Ulong	4	H+4	-
4	1st half mask1	Index into PRN mask (Type 1)	Ulong	4	H+8	-
5	1st half iode1	Issue of ephemeris data	Ulong	4	H+12	-
6	1st half dx1	Delta x (ECEF)	Long	4	H+16	0.125
7	1st half dy1	Delta y (ECEF)	Long	4	H+20	0.125
8	1st half dz1	Delta z (ECEF)	Long	4	H+24	0.125
9	1st half a _{f0}	Delta a _{f0} clock offset	Long	4	H+28	2 ⁻³¹

Field	Field type	Description	Format	Binary Bytes	Binary Offset	Scaling
10	1st half mask2	Second index into PRN mask (Type 1) Dummy value when velocity code = 1	Ulong	4	H+32	-
11	1st half iode2	Second issue of ephemeris data Dummy value when velocity code = 1	Ulong	4	H+36	-
12	1st half ddx	Delta delta x (ECEF) when velocity code = 1 Delta x (dx) when velocity code = 0	Long	4	H+40	2^{-11}
13	1st half ddy	Delta delta y (ECEF) when velocity code = 1 Delta y (dy) when velocity code = 0	Long	4	H+44	2^{-11}
14	1st half ddz	Delta delta z (ECEF) when velocity code = 1 Delta z (dz) when velocity code = 0	Long	4	H+48	2^{-11}
15	1st half a_{f1}	Delta a_{f1} clock offset when velocity code = 1 Delta a_{f0} clock offset when velocity code = 0	Long	4	H+52	2^{-39}
16	1st half t_0	Applicable time of day Dummy value when velocity code = 0	Ulong	4	H+56	16
17	1st half iodp	Issue of PRN mask data	Ulong	4	H+60	-
18	1st half corr spare	Spare value when velocity code = 0 Dummy value when velocity code = 1	Ulong	4	H+64	-
19	2nd half vel	Velocity code flag (0 or 1)	Ulong	4	H+68	-
20	2nd half mask1	Index into PRN mask (Type 1)	Ulong	4	H+72	-
21	2nd half iode1	Issue of ephemeris data	Ulong	4	H+76	-
22	2nd half dx1	Delta x (ECEF)	Long	4	H+80	0.125
23	2nd half dy1	Delta y (ECEF)	Long	4	H+84	0.125

Field	Field type	Description	Format	Binary Bytes	Binary Offset	Scaling
24	2nd half dz1	Delta z (ECEF)	Long	4	H+88	0.125
25	2nd half a _{f0}	Delta a _{f0} clock offset	Long	4	H+92	2 ⁻³¹
26	2nd half mask2	Second index into PRN mask (Type 1) Dummy value when velocity code = 1	Ulong	4	H+96	-
27	2nd half iode2	Second issue of ephemeris data Dummy value when velocity code = 1	Ulong	4	H+100	-
28	2nd half ddx	Delta delta x (ECEF) when velocity code = 1 Delta x (dx) when velocity code = 0	Long	4	H+104	2 ⁻¹¹
29	2nd half ddy	Delta delta y (ECEF) when velocity code = 1 Delta y (dy) when velocity code = 0	Long	4	H+108	2 ⁻¹¹
30	2nd half ddz	Delta delta z (ECEF) when velocity code = 1 Delta z (dz) when velocity code = 0	Long	4	H+112	2 ⁻¹¹
31	2nd half a _{f1}	Delta a _{f1} clock offset when velocity code = 1 Delta a _{f0} clock offset when velocity code = 0	Long	4	H+116	2 ⁻³⁹
32	2nd half t ₀	Applicable time of day Dummy value when velocity code = 0	Ulong	4	H+120	16
33	2nd half iodp	Issue of PRN mask data	Ulong	4	H+124	-
34	2nd half corr spare	Spare value when velocity code = 0 Dummy value when velocity code = 1	Ulong	4	H+128	-
35	xxxx	32-bit CRC (ASCII and Binary only)	Ulong	4	H+132	-
36	[CR][LF]	Sentence terminator (ASCII only)	-	-	-	-

3.173 SBAS26

Ionospheric delay corrections

Platform: OEM719, OEM729, OEM7500, OEM7600, OEM7700, OEM7720, PwrPak7, SPAN CPT7, SMART7, SMART2

SBAS26 provides vertical delays (relative to an L1 signal) and their accuracy at geographically defined IGP's identified by the BAND NUMBER and IGP number. Each message contains a band number and a block ID, which indicates the location of the IGP's in the respective band mask.

Message ID: 985

Log Type: Asynch

Recommended Input:

```
log SBAS26a onchanged
```

ASCII Example:

```
#SBAS26A,COM1,0,38.0,SATTIME,1337,417243.000,02000000,ec70,1984;134,1,2,15,27,1
1,25,11,23,11,19,11,16,11,16,12,15,13,16,13,29,14,30,13,27,11,27,11,24,11,19,11
,16,12,2,0*3b6d6806
```



Each raw SBAS frame gives data for a specific frame decoder number. The SBAS26 message can be logged to view the data breakdown of SBAS frame 26 which contains ionospheric delay corrections

Field	Field type	Description	Format	Binary Bytes	Binary Offset
1	SBAS26 header	Log header. See <i>Messages</i> on page 27 for more information.		H	0
2	prn	Source PRN of message	Ulong	4	H
3	band num	Band number	Ulong	4	H+4
4	block id	Block ID	Ulong	4	H+8
5	#pts	Number of grid points with information to follow	Ulong	4	H+12
6	igp _{vde}	IGP vertical delay estimates Scaling = 0.125	Ulong	4	H+16
7	givei	Grid ionospheric vertical error indicator	Ulong	4	H+20
8...	Next #pts entry = H + 16 + (#pts x 8)				
9	iodi	Issue of data - ionosphere	Ulong	4	H+16+ (#pts x 8)

Field	Field type	Description	Format	Binary Bytes	Binary Offset
10	spare	7 spare bits	Ulong	4	H+20+ (#pts x 8)
11	xxxx	32-bit CRC (ASCII and Binary only)	Ulong	4	H+24+ (#pts x 8)
12	[CR][LF]	Sentence terminator (ASCII only)	-	-	-

3.174 SBAS27

SBAS service message

Platform: OEM719, OEM729, OEM7500, OEM7600, OEM7700, OEM7720, PwrPak7, SPAN CPT7, SMART7, SMART2

SBAS27 messages apply only to the service provider transmitting the message. The number of service messages indicates the total number of unique SBAS27 messages for the current IODS. Each unique message for that IODS includes a sequential message number. The IODS is incremented in all messages, each time that any parameter in any SBAS27 message is changed.

Message ID: 986

Log Type: Asynch

Recommended Input:

```
log SBAS27a onchanged
```



Each raw SBAS frame gives data for a specific frame decoder number. The SBAS27 message can be logged to view the data breakdown of SBAS frame 27 which contains information about SBAS service messages.

Field	Field type	Description	Format	Binary Bytes	Binary Offset
1	SBAS27 header	Log header. See <i>Messages</i> on page 27 for more information.		H	0
2	prn	Source PRN of message	Ulong	4	H
3	iods	Issue of slow corrections data	Ulong	4	H+4
4	#messages	Low-by-one count of messages	Ulong	4	H+8
5	message num	Low-by-one message number	Ulong	4	H+12
6	priority code	Priority code	Ulong	4	H+16
7	dudre inside	Delta user differential range error – inside	Ulong	4	H+20
8	dudre outside	Delta user differential range error – outside	Ulong	4	H+24
9...	#reg	Number of regions with information to follow	Ulong	4	H+28
10	lat1	Coordinate 1 latitude	Long	4	H+32
11	lon1	Coordinate 1 longitude	Long	4	H+36

Field	Field type	Description	Format	Binary Bytes	Binary Offset
12	lat2	Coordinate 2 latitude	Long	4	H+40
13	lon2	Coordinate 2 longitude	Long	4	H+44
14	shape	Shape where: 0 = triangle, 1 = square	Ulong	4	H+48
15	Next #reg entry = H+32+(#reg x 20)				
16	Reserved		Ulong	4	H+32+ (#reg x 20)
17	xxxx	32-bit CRC (ASCII and Binary only)	Ulong	4	H+36+ (#reg x 20)
18	[CR][LF]	Sentence terminator (ASCII only)	-	-	-

3.175 SBAS32

Fast correction slots 0-10

Platform: OEM719, OEM729, OEM7500, OEM7600, OEM7700, OEM7720, PwrPak7, SPAN CPT7, SMART7, SMART2

SBAS32 are fast corrections for slots 0-10 in the mask of SBAS1, see **SBAS1** log on page 721.

Message ID: 988

Log Type: Asynch

Recommended Input:

log SBAS32a onchanged

ASCII Example:

```
#SBAS32A,COM2,0,70.5,FINE,1295,153284.000,02000240,18e9,34461;209,0,0,-
8097,0,0,0,0,-947,0,-2128,0,2570,14,0,14,14,14,14,0,14,0,14,0*58778ae5
```

Field	Field type	Description	Format	Binary Bytes	Binary Offset
1	SBAS32 header	Log header. See <i>Messages</i> on page 27 for more information.		H	0
2	prn	Source PRN of message	Ulong	4	H
3	iodp	Issue of PRN mask data	Ulong	4	H+4
4	prc0	prc(i): Fast corrections (-2048 to +2047) for the PRN in slot i (i = 0-10)	Long	4	H+8
5	prc1		Long	4	H+12
6	prc2		Long	4	H+16
7	prc3		Long	4	H+20
8	prc4		Long	4	H+24
9	prc5		Long	4	H+28
10	prc6		Long	4	H+32
11	prc7		Long	4	H+36
12	prc8		Long	4	H+40
13	prc9		Long	4	H+44
14	prc10		Long	4	H+48

Field	Field type	Description	Format	Binary Bytes	Binary Offset
15	udre0	udre(i): User differential range error indicator for the PRN in slot i (i = 0-10) See <i>Table 169: Evaluation of UDREI</i> below for scaling information	Ulong	4	H+52
16	udre1		Ulong	4	H+56
17	udre2		Ulong	4	H+60
18	udre3		Ulong	4	H+64
19	udre4		Ulong	4	H+68
20	udre5		Ulong	4	H+72
21	udre6		Ulong	4	H+76
22	udre7		Ulong	4	H+80
23	udre8		Ulong	4	H+84
24	udre9		Ulong	4	H+88
25	udre10		Ulong	4	H+92
26	xxxx	32-bit CRC (ASCII and Binary only)	Ulong	4	H+96
27	[CR][LF]	Sentence terminator (ASCII only)	-	-	-

Table 169: Evaluation of UDREI

UDREI	UDRE meters
0	0.01
1	0.02
2	0.03
3	0.05
4	0.10
5	0.15
6	0.20
7	0.25
8	0.30
9	0.35
10	0.40
11	0.45
12	0.50

UDREI	UDRE meters
13	0.60
14	Not Monitored
15	Do Not Use

3.176 SBAS33

Fast correction slots 11-21

Platform: OEM719, OEM729, OEM7500, OEM7600, OEM7700, OEM7720, PwrPak7, SPAN CPT7, SMART7, SMART2

SBAS33 are fast corrections for slots 11-21.

Message ID: 989

Log Type: Asynch

Recommended Input:

```
log SBAS33a onchanged
```

ASCII Example:

```
#SBAS33A,COM2,0,47.5,FINE,1295,158666.000,03000240,b23e,34461;209,0,0,-  
3343,0,0,0,-533,0,0,0,0,0,14,0,14,14,14,0,14,14,14,14,14*6d890f5f
```



Each raw mask frame gives data for a specific frame decoder number. The SBAS33 message can be logged to view the data breakdown of SBAS frame 33 which contains information about correction slots 11-21.

Field	Field type	Description	Format	Binary Bytes	Binary Offset
1	SBAS33 header	Log header. See <i>Messages</i> on page 27 for more information.		H	0
2	prn	Source PRN of message	Ulong	4	H
3	iodp	Issue of PRN mask data	Ulong	4	H+4

Field	Field type	Description	Format	Binary Bytes	Binary Offset
4	prc11	prc(i): Fast corrections (-2048 to +2047) for the PRN in slot i (i = 11-21)	Long	4	H+8
5	prc12		Long	4	H+12
6	prc13		Long	4	H+16
7	prc14		Long	4	H+20
8	prc15		Long	4	H+24
9	prc16		Long	4	H+28
10	prc17		Long	4	H+32
11	prc18		Long	4	H+36
12	prc19		Long	4	H+40
13	prc20		Long	4	H+44
14	prc21		Long	4	H+48
15	udre11		udre(i): User differential range error indicator for the PRN in slot i (i = 11-21) See <i>Table 169: Evaluation of UDREI</i> on page 758 for scaling information	Ulong	4
16	udre12	Ulong		4	H+56
17	udre13	Ulong		4	H+60
18	udre14	Ulong		4	H+64
19	udre15	Ulong		4	H+68
20	udre16	Ulong		4	H+72
21	udre17	Ulong		4	H+76
22	udre18	Ulong		4	H+80
23	udre19	Ulong		4	H+84
24	udre20	Ulong		4	H+88
25	udre21	Ulong		4	H+92
26	xxxx	32-bit CRC (ASCII and Binary only)	Ulong	4	H+96
27	[CR][LF]	Sentence terminator (ASCII only)	-	-	-

3.177 SBAS34

Fast correction slots 22-32

Platform: OEM719, OEM729, OEM7500, OEM7600, OEM7700, OEM7720, PwrPak7, SPAN CPT7, SMART7, SMART2

SBAS34 are fast corrections for slots 22-32 in the mask of SBAS1, see **SBAS1** log on page 721.

Message ID: 990

Log Type: Asynch

Recommended Input:

```
log SBAS34a onchanged
```

ASCII Example:

```
#SBAS34A,COM2,0,73.0,FINE,1295,226542.000,02000040,1be8,34461;209,0,5879,0,0,0,0,2687,0,10922,10922,10922,10922,0,14,14,14,14,0,14,15,15,15,15*3aeb74be
```



Each raw mask frame gives data for a specific frame decoder number. The SBAS34 message can be logged to view the data breakdown of SBAS frame 34 which contains information about fast correction slots 22-32.

Field	Field type	Description	Format	Binary Bytes	Binary Offset
1	SBAS34 header	Log header. See <i>Messages</i> on page 27 for more information.		H	0
2	prn	Source PRN of message	Ulong	4	H
3	iodp	Issue of PRN mask data	Ulong	4	H+4

Field	Field type	Description	Format	Binary Bytes	Binary Offset	
4	prc22	prc(i): Fast corrections (-2048 to +2047) for the PRN in slot i (i = 22-32)	Long	4	H+8	
5	prc23		Long	4	H+12	
6	prc24		Long	4	H+16	
7	prc25		Long	4	H+20	
8	prc26		Long	4	H+24	
9	prc27		Long	4	H+28	
10	prc28		Long	4	H+32	
11	prc29		Long	4	H+36	
12	prc30		Long	4	H+40	
13	prc31		Long	4	H+44	
14	prc32		Long	4	H+48	
15	udre22		udre(i): User differential range error indicator for the PRN in slot i (i = 22-32) See <i>Table 169: Evaluation of UDREI</i> on page 758 for scaling information	Ulong	4	H+52
16	udre23			Ulong	4	H+56
17	udre24			Ulong	4	H+60
18	udre25	Ulong		4	H+64	
19	udre26	Ulong		4	H+68	
20	udre27	Ulong		4	H+72	
21	udre28	Ulong		4	H+76	
22	udre29	Ulong		4	H+80	
23	udre30	Ulong		4	H+84	
24	udre31	Ulong		4	H+88	
25	udre32	Ulong		4	H+92	
26	xxxx	32-bit CRC (ASCII and Binary only)	Ulong	4	H+96	
27	[CR][LF]	Sentence terminator (ASCII only)	-	-	-	

3.178 SBAS35

Fast correction slots 33-43

Platform: OEM719, OEM729, OEM7500, OEM7600, OEM7700, OEM7720, PwrPak7, SPAN CPT7, SMART7, SMART2

SBAS35 are fast corrections for slots 33-43 in the mask of SBAS1, see **SBAS1** log on page 721.

Message ID: 991

Log Type: Asynch

Recommended Input:

log SBAS35a onchanged



Each raw mask frame gives data for a specific frame decoder number. The SBAS35 message can be logged to view the data breakdown of SBAS frame 35 which contains information about fast correction slots 33-43.

Field	Field type	Description	Format	Binary Bytes	Binary Offset
1	SBAS35 header	Log header. See <i>Messages</i> on page 27 for more information.		H	0
2	prn	Source PRN of message	Ulong	4	H
3	iodp	Issue of PRN mask data	Ulong	4	H+4
4	prc33	prc(i): Fast corrections (-2048 to +2047) for the PRN in slot i (i = 33-43)	Long	4	H+8
5	prc34		Long	4	H+12
6	prc35		Long	4	H+16
7	prc36		Long	4	H+20
8	prc37		Long	4	H+24
9	prc38		Long	4	H+28
10	prc39		Long	4	H+32
11	prc40		Long	4	H+36
12	prc41		Long	4	H+40
13	prc42		Long	4	H+44
14	prc43		Long	4	H+48

Field	Field type	Description	Format	Binary Bytes	Binary Offset
15	udre33	udre(i): User differential range error indicator for the PRN in slot i (i = 33-43) See <i>Table 169: Evaluation of UDREI</i> on page 758 for scaling information	Ulong	4	H+52
16	udre34		Ulong	4	H+56
17	udre35		Ulong	4	H+60
18	udre36		Ulong	4	H+64
19	udre37		Ulong	4	H+68
20	udre38		Ulong	4	H+72
21	udre39		Ulong	4	H+76
22	udre40		Ulong	4	H+80
23	udre41		Ulong	4	H+84
24	udre42		Ulong	4	H+88
25	udre43		Ulong	4	H+92
26	xxxx		32-bit CRC (ASCII and Binary only)	Ulong	4
27	[CR][LF]	Sentence terminator (ASCII only)	-	-	-

3.179 SBAS45

Slow corrections

Platform: OEM719, OEM729, OEM7500, OEM7600, OEM7700, OEM7720, PwrPak7, SPAN CPT7, SMART7, SMART2

Each SBAS45 message contains a 2-bit IODP indicating the associated PRN mask.

The time of applicability (T0) of the PRC is the start of the epoch of the WNT second that is coincident with the transmission at the satellite of the first bit of the message block.

Message ID: 993

Log Type: Asynch

Recommended Input:

```
log SBAS45a onchanged
```

ASCII Example:

```
#SBAS45A,COM2,0,73.0,FINE,1295,228498.000,02000040,c730,34461;209,23,32,197,-116,206,-1,-6,-3,-5546,3488,25,148,262,-312,867,4,3,0,2513,3488,0*02d6e0d5
```



Each raw mask frame gives data for a specific frame decoder number. The SBAS45 message can be logged to view the data breakdown of SBAS frame 45 which contains information about slow corrections.

Field	Field type	Description	Format	Binary Bytes	Binary Offset	Scaling
1	SBAS45 header	Log header. See <i>Messages</i> on page 27 for more information.		H	0	-
2	prn	Source PRN of message	Ulong	4	H	-
3	mask1	Index into PRN mask (Type 1)	Ulong	4	H+4	-
4	iode1	Issue of ephemeris data	Ulong	4	H+8	-
5	dx1	Delta x (ECEF)	Long	4	H+12	0.125
6	dy1	Delta y (ECEF)	Long	4	H+16	0.125
7	dz1	Delta z (ECEF)	Long	4	H+20	0.125
8	ddx1	Delta delta x (ECEF)	Long	4	H+24	2 ⁻¹¹
9	ddy1	Delta delta y (ECEF)	Long	4	H+28	2 ⁻¹¹
10	ddz1	Delta delta z (ECEF)	Long	4	H+32	2 ⁻¹¹
11	da _{f0} 1	Delta a _{f0} clock offset	Long	4	H+36	2 ⁻³¹

Field	Field type	Description	Format	Binary Bytes	Binary Offset	Scaling
12	t ₀ 1	Applicable time of day	Ulong	4	H+40	16
13	mask2	Second index into PRN mask (Type 1)	Ulong	4	H+44	-
14	iode2	Second issue of ephemeris data	Ulong	4	H+48	-
15	dx2	Delta x (ECEF)	Long	4	H+52	0.125
16	dy2	Delta y (ECEF)	Long	4	H+56	0.125
17	dz2	Delta z (ECEF)	Long	4	H+60	0.125
18	ddx2	Delta delta x (ECEF)	Long	4	H+64	2 ⁻¹¹
19	ddy2	Delta delta y (ECEF)	Long	4	H+68	2 ⁻¹¹
20	ddz2	Delta delta z (ECEF)	Long	4	H+72	2 ⁻¹¹
21	da _{f0} 2	Delta a _{f0} clock offset	Long	4	H+76	2 ⁻³¹
22	t ₀ 2	Applicable time of day	Ulong	4	H+80	16
23	iodp	Issue of PRN mask data	Ulong	4	H+84	-
24	xxxx	32-bit CRC (ASCII and Binary only)	Ulong	4	H+88	-
25	[CR][LF]	Sentence terminator (ASCII only)	-	-	-	-

3.180 SBASALMANAC

SBAS Almanac collection

Platform: OEM719, OEM729, OEM7500, OEM7600, OEM7700, OEM7720, PwrPak7, SPAN CPT7, SMART7, SMART2

This log contains a collection of all current SBAS almanacs that have been decoded by the receiver and may contain almanac data for multiple PRNs. The SBASALMANAC log is populated by the GEO Almanac Message Type 17 which is available in the **SBAS17** log (see page 743). These PRNs are broken out into individual SBAS almanac entries for this message and output individually. If multiple SBAS subsystems (e.g., WAAS, EGNOS, GAGAN, MSAS) are tracked, this message will include almanac data collected from each with the subsystem identified in each message entry. The almanac data contains all of the information required to compute the satellite position as well as health and status information.

The OEM7 family of receivers automatically save almanacs in their Non-Volatile Memory (NVM), so creating an almanac boot file is not necessary.

Message ID: 1425

Log Type: Asynch

Recommended Input:

Log SBASALMANACA onchanged

ASCII Example:

```
#SBASALMANACA,COM1,2,80.0,SATTIME,1672,411186.000,02000020,84d8,43119;133,WAAS,65600,0,0,-5571800,-41758600,-1456000,0,0,120*22da17e8
```

```
#SBASALMANACA,COM1,1,80.0,SATTIME,1672,411186.000,02000020,84d8,43119;135,WAAS,65600,0,0,-28758600,-30825600,0,0,0,0*dd122ca1
```

```
#SBASALMANACA,COM1,0,80.0,SATTIME,1672,411186.000,02000020,84d8,43119;138,WAAS,65600,0,0,-12547600,-40248000,0,0,0,0*89c6c51c
```

Field	Field Type	Description	Format	Binary Bytes	Binary Offset
1	SBASALMANAC Header	Log header. See <i>Messages</i> on page 27 for more information.		H	0
2	Satellite ID	Satellite ID	Ulong	4	H
3	Variant	System variant (refer to <i>Table 170: SBAS Subsystem Types</i> on the next page)	Enum	4	H + 4
4	Time	Time of day (s)	Ulong	4	H + 8
5	Data ID	Data identification	Ushort	2	H + 12
6	Health	Satellite health	Ushort	2	H + 14
7	X	ECEF X coordinate (m)	Long	4	H + 16

Field	Field Type	Description	Format	Binary Bytes	Binary Offset
8	Y	ECEF Y coordinate (m)	Long	4	H + 20
9	Z	ECEF Z coordinate (m)	Long	4	H + 24
10	X Velocity	X rate of change (m/s)	Long	4	H + 28
11	Y Velocity	Y rate of change (m/s)	Long	4	H + 32
12	Z Velocity	Z rate of change (m/s)	Long	4	H + 36
13	CRC	32-bit CRC (ASCII and binary only)	Ulong	4	H + 40
14	[CR][LF]	Sentence terminator (ASCII only)	-	-	-

Table 170: SBAS Subsystem Types

ASCII	Binary	Description
NONE	0	No system
UNKNOWN	1	Unknown system
WAAS	2	WAAS system
EGNOS	3	EGNOS system
MSAS	4	MSAS system
GAGAN	5	GAGAN system
QZSS	7	QZSS System

3.181 SOFTLOADSTATUS

Describes the status of the SoftLoad process

Platform: OEM719, OEM729, OEM7500, OEM7600, OEM7700, OEM7720, PwrPak7, SPAN CPT7, SMART7, SMART2

This log describes the status of the SoftLoad process.



Status values ≥ 16 (ERROR) indicate that an error has occurred during the loading process. Status < 16 (ERROR) are part of normal SoftLoad operation.

Message ID: 1235

Log Type: Asynch

Recommended Input:

```
log softloadstatusa onchanged
```

ASCII Example:

```
#SOFTLOADSTATUSA, COM1, 0, 97.5, UNKNOWN, 0, 0.113, 024c0001, 2d64, 10481;NOT_
STARTED*827fdc04
```

Field	Field Type	Description	Format	Binary Bytes	Binary Offset
1	SOFTLOADSTATUS header	Log header. See <i>Messages</i> on page 27 for more information.	-	H	0
2	status	Status of the SoftLoad process see <i>Table 171: SoftLoad Status Type</i> below	Enum	4	H
3	xxxx	32-bit CRC (ASCII and Binary only)	Ulong	4	H+4
4	[CR][LF]	Sentence terminator (ASCII only)	-	-	-

Table 171: SoftLoad Status Type

Value	Name	Description
1	NOT_STARTED	SoftLoad process has not begun.
2	READY_FOR_SETUP	SoftLoad process is ready to receive setup information in the form of the SOFTLOADSETUP command or SOFTLOADSREC command with S0 records. Once sufficient setup data has been sent, the process is also ready for the SOFTLOADDATA command.
3	READY_FOR_DATA	SoftLoad process is ready to receive data in the form of the SOFTLOADDATA command or SOFTLOADSREC command with S3 records. Once all data has been sent, send the SOFTLOADCOMMIT command.

Value	Name	Description
4	DATA_VERIFIED	SoftLoad data has passed CRC. This status occurs after a SOFTLOADCOMMIT command.
5	WRITING_FLASH	SoftLoad data is being written to flash. This status occurs after a SOFTLOADCOMMIT command. During a firmware upload, the receiver may remain in this state for 300 seconds or longer.
6	WROTE_FLASH	SoftLoad data has been written to flash.
7	WROTE_AUTHCODE	The embedded AuthCode was successfully written.
8	COMPLETE	SoftLoad process has completed. The next step is to send the RESET command to reset the receiver.
9	VERIFYING_DATA	SoftLoad is verifying the downloaded image.
10	COPIED_SIGNATURE_AUTH	Signature AuthCodes have been copied from the current firmware to the downloaded firmware.
11	WROTE_TRANSACTION_TABLE	The downloaded firmware has been activated and will be executed if the receiver is reset. This status is effectively identical to COMPLETE.
16	ERROR	Indicates an internal error in the SoftLoad process. This error is not expected to occur. Contact NovAtel Customer Support for assistance.
17	RESET_ERROR	Error resetting SoftLoad. Reset the receiver and restart the SoftLoad process.
18	BAD_SRECORD	A bad S Record was received. Ensure that S Records are enclosed in double quotes within the SOFTLOADSREC command.
19	BAD_PLATFORM	This data cannot be loaded onto this platform. Ensure that the correct *.shex file for the platform is being used.
20	BAD_MODULE	This module cannot be loaded with SoftLoad. This file must be loaded using WinLoad or a similar loader.
21	BAD_AUTHCODE	Bad AuthCode received for this PSN.
22	NOT_READY_FOR_SETUP	A SOFTLOADSETUP command was entered before a SOFTLOADRESET command or after a SOFTLOADDATA command.
23	NO_MODULE	No data type was entered before a SOFTLOADDATA command was received. Set the data type using the SOFTLOADSETUP command or SOFTLOADSREC command with an "S0~T~" S Record.

Value	Name	Description
24	NO_PLATFORM	No platform was entered before a SOFTLOADDATA command was received. Set the platform using the SOFTLOADSETUP command or SOFTLOADSREC command with an "S0~P~" S Record.
25	NOT_READY_FOR_DATA	A SOFTLOADDATA command was received but the receiver was not ready for it.
26	MODULE_MISMATCH	The SoftLoad data module was changed in the middle of loading. Restart the SoftLoad process using the SOFTLOADRESET command.
27	OUT_OF_MEMORY	SoftLoad has run out of RAM to store the incoming data. Reset the receiver and restart the SoftLoad process.
28	DATA_OVERLAP	SoftLoad data has overlapped. Ensure that the correct address and length is set in the SOFTLOADDATA command or SOFTLOADSREC command.
29	BAD_IMAGE_CRC	CRC of the downloaded image has failed. Ensure that all content from the *.shex file has been successfully downloaded.
30	IMAGE_OVERSIZE	The downloaded image is too big for the intended data module.
31	AUTHCODE_WRITE_ERROR	An error occurred when writing the embedded AuthCode to flash.
32	BAD_FLASH_ERASE	Erasing of the flash failed. This could indicate a failure in the flash hardware.
33	BAD_FLASH_WRITE	Writing to the flash failed. This could indicate a failure in the flash hardware.
34	TIMEOUT	SoftLoad time out has occurred.
35	INCOMPATIBLE_FLASH	Application image that does not support the onboard flash rejected.

3.182 SOURCETABLE

NTRIP source table entries

Platform: OEM729, OEM7600, OEM7700, OEM7720, PwrPak7, SPAN CPT7, SMART7-W, SMART7-I

This log outputs the NTRIP source table entries from the NTRIP caster set by the **NTRIP SOURCETABLE** command (see page 201). The entry data field in the first entry is always the header of the retrieved SOURCETABLE. The entry data field in the last entry is always a string "ENDSOURCETABLE" which indicates the end of the source table. Entries in between these fields are the real SOURCETABLE entries.

Message ID: 1344

Log Type: Polled

Recommended Input:

```
log sourcetablea once
```

ASCII Example:

```
#SOURCETABLEA,COM1,17,84.0,COARSESTEERING,1933,497547.000,02400020,71dd,32768;
"hera.novatel.com:2101",0,0,"HTTP/1.1 200 OK;Ntrip-Version: Ntrip/2.0;Ntrip-
Flags: st_filter,st_auth,st_match,st_strict,rtsp,plain_rtp;Server: NTRIP
Caster/2.0.15;Date: Fri, 27 Jan 2017 18:12:01 GMT;Connection: close;Content-
Type: gnss/sourcetable;Content-Length: 2057"*87a7d39d

#SOURCETABLEA,COM1,16,84.0,COARSESTEERING,1933,497547.000,02400020,71dd,32768;
"hera.novatel.com:2101",0,0,"CAS;hera.novatel.ca;80,2101;NovAtel;NovAtel;0;CAN;
51;-115;http://www.novatel.com"*e3ec11a0

#SOURCETABLEA,COM1,15,84.0,COARSESTEERING,1933,497547.000,02400020,71dd,32768;
"hera.novatel.com:2101",0,0,"NET;GREF;NovAtel;B;N;http://novatel.com;none;novat
el.com;none"*2a6b50eb

#SOURCETABLEA,COM1,14,84.0,COARSESTEERING,1933,497547.000,02400020,71dd,32768;
"hera.novatel.com:2101",0,0,"STR;novatel_rtcmv3;Office Roof DL1L2;RTCM 3.0;1033
(10),1005(10),1019(60),1020(60),1003(1),1011(1);2;GPS+GLO;NovAtel;CAN;51;-115;
0;0;NovAtel OEM628;none;B;N;9600;Test"*8a7c760f

#SOURCETABLEA,COM1,13,84.0,COARSESTEERING,1933,497547.000,02400020,71dd,32768;
"hera.novatel.com:2101",0,0,"STR;novatel_rtcm;Office Roof DL1L2;RTCM 2.3;1(1),3
(10),31(1),32(10);0;GPS+GLO;NovAtel;CAN;51;-115;0;0;NovAtel OEM628;none;B;N;
9600;Test"*08c57cb7

#SOURCETABLEA,COM1,12,84.0,COARSESTEERING,1933,497547.000,02400020,71dd,32768;
"hera.novatel.com:2101",0,0,"STR;novatel_rtca;Office Roof DL1L2;RTCA;RTCAREF
(10),RTCA1(1),RTCAEPHEM(60);0;GPS;NovAtel;CAN;51;-115;0;0;NovAtel OEM628;none;
B;N;9600;Test"*006997bc

#SOURCETABLEA,COM1,11,84.0,COARSESTEERING,1933,497547.000,02400020,71dd,32768;
"hera.novatel.com:2101",0,0,"STR;novatel_cm;Office Roof DL1L2;CMR;CMRREF(10),
CMROBS(1),CMRGLOBS(1);2;GPS+GLO;NovAtel;CAN;51;-115;0;0;NovAtel OEM628;none;
B;N;9600;Test"*0955ccb7

#SOURCETABLEA,COM1,10,84.0,COARSESTEERING,1933,497547.000,02400020,71dd,32768;
"hera.novatel.com:2101",0,0,"STR;novatel_rtcaobs2;Office Roof DL1L2;RTCA;
```

```

rtcaref (10) , rtcaobs2 (1) , rtcaephem (60) ; 2;GPS+GLO;NovAtel;CAN;51;-115;0;0;NovAtel
OEM628;none;B;N;9600;Test"*426e39a5

#SOURCETABLEA,COM1,9,84.0,COARSESTEERING,1933,497547.000,02400020,71dd,32768;
"hera.novatel.com:2101",0,0,"STR;novatel_cmrplus;Office Roof DL1L2;CMR+;cmrplus
(1),cmrobs(1),cmrgloobs(1);2;GPS+GLO;NovAtel;CAN;51;-115;0;0;NovAtel OEM628;
none;B;N;9600;Test"*2d5ba56e

#SOURCETABLEA,COM1,8,84.0,COARSESTEERING,1933,497547.000,02400020,71dd,32768;"h
era.novatel.com:2101",0,0,"STR;novatel_rtc2021;Office Roof DL1L2;RTCM 2.3;3
(10),2021(1);2;GPS+GLO;NovAtel;CAN;51;-115;0;0;NovAtel
OEM628;none;B;N;9600;Test"*d82df5de

#SOURCETABLEA,COM1,7,84.0,COARSESTEERING,1933,497547.000,02400020,71dd,32768;
"hera.novatel.com:2101",0,0,"STR;novatel_1819;Office Roof DL1L2;RTCM 2.3;3(10),
22(10),23(60),24(60),1819(1);2;GPS+GLO;NovAtel;CAN;51;-115;0;0;NovAtel OEM628;
none;B;N;9600;Test"*7aead153

#SOURCETABLEA,COM1,6,84.0,COARSESTEERING,1933,497547.000,02400020,71dd,32768;"h
era.novatel.com:2101",0,0,"STR;novatel_rtcaobs;Office Roof DL1L2;RTCA;rtcaref
(10),rtcaobs(1),rtcaephem(60);2;GPS+GLO;NovAtel;CAN;51;-115;0;0;NovAtel
OEM628;none;B;N;9600;Test"*530a51c4

#SOURCETABLEA,COM1,5,84.0,COARSESTEERING,1933,497547.000,02400020,71dd,32768;
"hera.novatel.com:2101",0,0,"STR;novatel_novatelx;Office Roof;NovatelX;
novatelobs;2;GPS+GLO;NovAel;CAN;51;-114;0;0;NovAtel OEM628;none;B;N;9600;
Test"*4438c2e2

#SOURCETABLEA,COM1,4,84.0,COARSESTEERING,1933,497547.000,02400020,71dd,32768;
"hera.novatel.com:2101",0,0,"STR;Hyderabad1;hyderabad test1;unknown;unknown;
2;GPS+GLO;NovAtel;INDIA;17;78;0;0;NovAtel OEM628;none;B;N;9600;Test"*de6c19f0

#SOURCETABLEA,COM1,3,84.0,COARSESTEERING,1933,497547.000,02400020,71dd,32768;
"hera.novatel.com:2101",0,0,"STR;Hyderabad2;hyderabad
test1;unknown;unknown;2;GPS+GLO;NovAtel;INDIA;17;78;0;0;NovAtel
OEM628;none;B;N;9600;Test"*27e9ee1

#SOURCETABLEA,COM1,2,84.0,COARSESTEERING,1933,497547.000,02400020,71dd,32768;"h
era.novatel.com:2101",0,0,"STR;Hyderabad3;hyderabad test1;unknown;unknown;
2;GPS+GLO;NovAtel;INDIA;17;78;0;0;NovAtel OEM628;none;B;N;9600;Test"*3ed5941b

#SOURCETABLEA,COM1,1,84.0,COARSESTEERING,1933,497547.000,02400020,71dd,32768;
"hera.novatel.com:2101",0,0,"STR;Hyderabad4;hyderabad test1;unknown;unknown;
2;GPS+GLO;NovAtel;INDIA;17;78;0;0;NovAtel OEM628;none;B;N;9600;Test"*a3a188e2

#SOURCETABLEA,COM1,0,84.0,COARSESTEERING,1933,497547.000,02400020,71dd,32768;
"hera.novatel.com:2101",0,0,"ENDSOURCETABLE"*7758fba9

```

Field	Field Type	Description	Format	Binary Bytes	Binary Offset
1	SOURCETABLE header	Log header. See <i>Messages</i> on page 27 for more information.		H	0

Field	Field Type	Description	Format	Binary Bytes	Binary Offset
2	endpoint	NTRIPCASTER Endpoint	String with varied length up to 80 bytes	a ¹	H
3	Reserved1	reserved	Ulong	4	H+a
4	Reserved2	reserved	Ulong	4	H+a+4
5	Entry data	Source table entry data	String with varied length up to 512 bytes	b ¹	H+a+8
6	xxxx	32-bit CRC (ASCII and binary only)	Ulong	4	H+a+b+8
7	[CR][LF]	Sentence terminator (ASCII only)	-	-	-

¹In the binary case, each string field needs to be NULL terminated and additional bytes of padding added to maintain 4-byte alignment, up to the maximum defined by the string size. The next defined field starts immediately at the next 4-byte alignment following the NULL.

3.183 TECTONICSCOMPENSATION

Tectonics Compensation status

Platform: OEM719, OEM729, OEM7500, OEM7600, OEM7700, OEM7720, PwrPak7, SPAN CPT7, SMART7, SMART2

This log shows the status of the tectonics compensation.

Message ID: 2291

Log Type: Asynch

Recommended Input:

```
log tectonicscompensationa onchanged
```

ASCII Example:

```
#TECTONICSCOMPENSATIONA,COM1,0,74.0,FINESTEERING,2044,511461.010,02000020,3af4,15427;AVAILABLE,"North America",-0.018,-0.000,-0.006*e85af7bf
```

Field	Field Type	Description	Format	Binary Bytes	Binary Offset
1	TECTONICS COMPENSATION header	Log header. See <i>Messages</i> on page 27 for more information.	-	H	0
2	status	Status of plate tectonics compensation. See <i>Table 172: Tectonics Compensation Status</i> below.	Enum	4	H
3	name	Name of the plate that is being used for determining station velocities.	Char (32)	Variable	H+4
4	xvel	Station velocities for the location of the receiver (meters/year)	Float	4	Variable
5	yvel		Float	4	Variable
6	zvel		Float	4	Variable
7	xxxx	32-bit CRC (ASCII and Binary only)	Ulong	4	Variable
8	[CR][LF]	Sentence terminator (ASCII only)	-	-	-

Table 172: Tectonics Compensation Status

Binary	ASCII	Description
0	UNAVAILABLE	Tectonics compensation is not available.
1	AVAILABLE	Tectonics compensation is available.
2	WARNING	The receiver is either close to a plate boundary or inside a region where the tectonics compensation is not well modeled.

Binary	ASCII	Description
4	OFF_PLATE	The receiver has moved from the plate that was initially selected. The receiver will not change the plate to avoid discontinuities in the positions.

3.184 TERRASTARINFO

TerraStar subscription information

Platform: OEM719, OEM729, OEM7500, OEM7600, OEM7700, OEM7720, PwrPak7, SPAN CPT7, SMART7, SMART2

This log contains details on the TerraStar subscription.

Message ID: 1719

Log Type: Asynch

Recommended Input:

```
log terrastarininfoa onchanged
```

ASCII Example:

```
#TERRASTARINFOA,COM1,0,78.0,FINESTEERING,2050,426971.997,02000000,91ea,14517;"QW503:1904:5936",TERM,00000700,120,2019,0,NEARSHORE,0.00000,0.00000,0*c930f2bd
```

Field	Field type	Description	Format	Binary Bytes	Binary Offset
1	TERRASTAR INFO header	Log header. See <i>Messages</i> on page 27 for more information.		H	0
2	PAC	Product activation code	Char [16]	16	H
3	Type	Subscription type (see <i>Table 173: TerraStar Subscription Type</i> on the next page)	Enum	4	H+16
4	Subscription permissions	Services permitted by the subscription (see <i>Table 174: TerraStar Subscription Details Mask</i> on the next page) Note: Bits in the Reserved areas of this field may be set, but the Reserved bits should be ignored. A receiver can have only one active subscription at a time but a subscription can enable multiple services or bits. For example, "00000700" indicates the receiver has a TerraStar-C subscription though TerraStar-L is also allowed.	Hex	4	H+20
5	Service End Day	Last day of the year for which service is available. Service expires at the end of this UTC day. For example, if the Service End Year and Day are 2019 and 15, respectively, then the service will expire on January 15, 2019 at 24:00 UTC.	Ulong	4	H+24

Field	Field type	Description	Format	Binary Bytes	Binary Offset
6	Service End Year	Year that subscription ends	Ulong	4	H+28
7	Reserved		Ulong	4	H+32
8	Region restriction	For region restricted subscriptions, the type of region restriction (see <i>Table 175: TerraStar Region Restriction</i> on the next page)	Enum	4	H+36
9	Center point latitude	For local area subscriptions, the center point latitude (degrees)	Float	4	H+40
10	Center point longitude	For local area subscriptions, the center point longitude (degrees)	Float	4	H+44
11	Radius	For local area subscriptions, the maximum permitted distance from center point (kilometers)	Ulong	4	H+48
12	xxxx	32-bit CRC (ASCII and Binary only)	Ulong	4	H+52
13	[CR][LF]	Sentence terminator (ASCII only)	-	-	-

Table 173: TerraStar Subscription Type

ASCII	Binary	Description
UNASSIGNED	0	Decoder has not had an assigned operating mode
TERM	1	Term subscription
MODEL	5	Receiver is operating with an RTK assist enabled model and there is not an active TerraStar subscription installed
BUBBLE	100	Receiver is operating in a TerraStar-permitted subscription-free bubble
INCOMPATIBLE_SUBSCRIPTION	104	Subscription is incompatible with this version of firmware

Table 174: TerraStar Subscription Details Mask

Bit	Mask	Description
0-8	0x000001FF	Reserved
9	0x00000200	TerraStar-C service
10	0x00000400	TerraStar-L service
11	0x00000800	RTK ASSIST service

Bit	Mask	Description
12	0x00001000	RTK ASSIST PRO service
13	0x00002000	TerraStar-C PRO service
14	0x00004000	TerraStar-X service
15-31	0xFFFF8000	Reserved

Table 175: TerraStar Region Restriction

ASCII	Binary	Description
NONE	0	TerraStar operation has no region restrictions.
GEOGATED	1	TerraStar operation limited to on-land GEOGATED is also the default value reported if there is no subscription
LOCAL_AREA	2	TerraStar operation limited to radius from local area center point
NEARSHORE	3	TerraStar operation limited to on land and near shore (coastal) regions

3.185 TERRASTARSTATUS

TerraStar decoder and subscription status

Platform: OEM719, OEM729, OEM7500, OEM7600, OEM7700, OEM7720, PwrPak7, SPAN CPT7, SMART7, SMART2

This log contains status information for the TerraStar decoder and subscription.

Message ID: 1729

Log Type: Asynch

Recommended Input:

```
log terrastarstatusa onchanged
```

ASCII Example:

```
#TERRASTARSTATUSA,COM1,0,49.5,FINESTEERING,1769,332336.443,02000000,fdc1,12602;
ENABLE,LOCKED,0,DISABLED,ONSHORE*555155a5
```

Field	Field type	Description	Format	Binary Bytes	Binary Offset
1	TERRASTAR STATUS header	Log header. See <i>Messages</i> on page 27 for more information.		H	0
2	Access	Access status. ENABLE (1) if the subscription is valid; DISABLE (0) otherwise	Enum	4	H
3	Sync state	Decoder data synchronization state (see <i>Table 176: Decoder Data Synchronization State</i> below)	Enum	4	H+4
4	Reserved		Ulong	4	H+8
5	Local area status	For local-area subscriptions, indicates if the receiver is within the permitted area (see <i>Table 177: TerraStar Local Area Status</i> on the next page)	Enum	4	H+12
6	Geogating status	Geogating status (see <i>Table 178: TerraStar Geogating Status</i> on the next page)	Enum	4	H+16
7	xxxx	32-bit CRC (ASCII and Binary only)	Ulong	4	H+20
8	[CR][LF]	Sentence terminator (ASCII only)	-	-	-

Table 176: Decoder Data Synchronization State

ASCII	Binary	Description
NO_SIGNAL	0	None of the decoders have received data in the last 30 seconds

ASCII	Binary	Description
SEARCH	1	At least one decoder is receiving data and is searching for the format
LOCKED	2	At lease one decoder has locked onto the format

Table 177: TerraStar Local Area Status

ASCII	Binary	Description
DISABLED	0	The subscription is not restricted to a local area. This is also the value when there is no subscription.
WAITING_FOR_POSITION	1	Waiting for a position
RANGE_CHECK	16	Checking position against local area region restriction
IN_RANGE	129	Receiver is within the permitted local area
OUT_OF_RANGE	130	Receiver is outside the permitted local area
POSITION_TOO_OLD	255	Position is too old

Table 178: TerraStar Geogating Status

ASCII	Binary	Description
DISABLED	0	The subscription is restricted to a local area or there is no region restriction. This is also the value when there is no subscription.
WAITING_FOR_POSITION	1	Waiting for a position
ONSHORE	129	Receiver is over land
OFFSHORE	130	Receiver is over water
POSITION_TOO_OLD	255	Position is too old
PROCESSING	1000	Geogater is determining status

3.186 TIME

Time data

Platform: OEM719, OEM729, OEM7500, OEM7600, OEM7700, OEM7720, PwrPak7, SPAN CPT7, SMART7, SMART2

This log provides several time related pieces of information including receiver clock offset and UTC time and offset. It can also be used to determine any offset in the PPS signal relative to GPS reference time.

To find any offset in the PPS signal, log the TIME log 'ontime' at the same rate as the PPS output. For example, if the PPS output is configured to output at a rate of 0.5 seconds (see the **PPSCONTROL** command on page 222) log the TIME log 'ontime 0.5' as follows:

```
log time ontime 0.5
```

The TIME log offset field can then be used to determine any offset in PPS output relative to GPS reference time.



GPS reference time is the receiver's estimate of the true GPS system time. GPS reference time can be found in the header of the TIME log. The relationship between GPS reference time and true GPS system time is:
GPS system time = GPS reference time - offset

Message ID: 101

Log Type: Synch

Recommended Input:

```
log timea ontime 1
```

ASCII Example:

```
#TIMEA, COM1, 0, 86.5, FINESTEERING, 1930, 428348.000, 02000020, 9924, 32768; VALID,
1.667187222e-10, 9.641617960e-10, -18.000000000000, 2017, 1, 5, 22, 58, 50000, VALID
*2a066e78
```

Field	Field type	Description	Format	Binary Bytes	Binary Offset
1	TIME header	Log header. See <i>Messages</i> on page 27 for more information.		H	0
2	clock status	Clock model status (not including current measurement data), see <i>Table 78: Clock Model Status</i> on page 400	Enum	4	H

Field	Field type	Description	Format	Binary Bytes	Binary Offset
3	offset	Receiver clock offset in seconds from GPS system time. A positive offset implies that the receiver clock is ahead of GPS system time. To derive GPS system time, use the following formula: GPS system time = GPS reference time - offset. The GPS reference time can be obtained from the log header.	Double	8	H+4
4	offset std	Receiver clock offset standard deviation (s)	Double	8	H+12
5	utc offset	The offset of GPS system time from UTC time, computed using almanac parameters. UTC time is GPS reference time plus the current UTC offset minus the receiver clock offset: UTC time = GPS reference time - offset + UTC offset	Double	8	H+20
6	utc year	UTC year	Ulong	4	H+28
7	utc month	UTC month (0-12) If UTC time is unknown, the value for month is 0.	Uchar	1	H+32
8	utc day	UTC day (0-31) If UTC time is unknown, the value for day is 0.	Uchar	1	H+33
9	utc hour	UTC hour (0-23)	Uchar	1	H+34
10	utc min	UTC minute (0-59)	Uchar	1	H+35
11	utc ms	UTC millisecond (0-60999) Maximum of 60999 when leap second is applied.	Ulong	4	H+36
12	utc status	UTC status 0 = Invalid 1 = Valid 2 = Warning ¹	Enum	4	H+40
13	xxxx	32-bit CRC (ASCII and Binary only)	Ulong	4	H+44
14	[CR][LF]	Sentence terminator (ASCII only)	-	-	-

¹Indicates that the leap second value is used as a default due to the lack of an almanac.

3.187 TIMESYNC

Synchronize time between GNSS receivers

Platform: OEM719, OEM729, OEM7500, OEM7600, OEM7700, OEM7720, PwrPak7, SPAN CPT7, SMART7, SMART2

The TIMESYNC log is used to synchronize the time between GNSS receivers.

Message ID: 492

Log Type: Synch

Recommended Input:

```
log timesynca ontime 1
```

ASCII Example:

```
#TIMESYNCA,COM1,0,46.0,FINESTEERING,1337,410095.000,02000000,bd3f,1984;1337,410095000,FINESTEERING*aa2025db
```

Field	Field type	Description	Format	Binary Bytes	Binary Offset
1	TIMESYNC header	Log header. See <i>Messages</i> on page 27 for more information.		H	0
2	week	GPS reference week number	Ulong	4	H
3	ms	Number of milliseconds into the GPS reference week	Ulong	4	H+4
4	time status	GPS reference time Status, see <i>Table 11: GPS Reference Time Status</i> on page 47	Enum	4	H+8
5	xxxx	32-bit CRC (ASCII and Binary only)	Ulong	4	H+12
6	[CR][LF]	Sentence terminator (ASCII only)	-	-	-

3.188 TRACKSTAT

Tracking status

Platform: OEM719, OEM729, OEM7500, OEM7600, OEM7700, OEM7720, PwrPak7, SPAN CPT7, SMART7, SMART2

The TRACKSTAT log contains an entry for each channel. If there are multiple signal channels for one satellite (for example L1, L2 P(Y), L2C, and L5 for GPS), then there will be multiple entries for that satellite.

As shown in *Table 121: Channel Tracking Status* on page 614 these entries can be differentiated by bit 20, which is set if there are multiple observables for a given satellite, and bits 21-25, which denote the signal type for the observation.

A zero in the PRN/slot of the TRACKSTAT log indicates the channel should be considered idle with the exception of those for GLONASS. A GLONASS channel should only be considered idle if the tracking state is 0 in the channel tracking status word.



For dual antenna receivers, a TRACKSTAT_1 log can be requested to get TRACKSTAT data from the second antenna. As described in *Table 3: Binary Message Header Structure* on page 31, the message type indicates the log is from the second antenna. To request an ASCII log enter TRACKSTATA_1 and for a binary log enter TRACKSTATB_1.

Message ID: 83

Log Type: Synch

Recommended Input:

```
log trackstata ontime 1
```

ASCII Example:

```
#TRACKSTATA,COM1,0,49.5,FINESTEERING,1337,410139.000,02000000,457c,1984;
SOL_COMPUTED,PSRDIFF,5.0,30,
1,0,18109c04,21836080.582,-2241.711,50.087,1158.652,0.722,GOOD,0.973,
1,0,11309c0b,21836083.168,-1746.788,42.616,1141.780,0.000,OBSL2,0.000,
30,0,18109c24,24248449.644,-2588.133,45.237,939.380,-0.493,GOOD,0.519,
30,0,11309c2b,24248452.842,-2016.730,38.934,939.370,0.000,OBSL2,0.000,
...
14,0,18109da4,24747286.206,-3236.906,46.650,1121.760,-0.609,GOOD,0.514,
14,0,11309dab,24747288.764,-2522.270,35.557,1116.380,0.000,OBSL2,0.000,
0,0,0c0221c0,0.000,0.000,0.047,0.000,0.000,NA,0.000,
0,0,0c0221e0,0.000,0.000,0.047,0.000,0.000,NA,0.000*255a732e
```

Field	Field Type	Description	Format	Binary Bytes	Binary Offset
1	TRACKSTAT header	Log header. See <i>Messages</i> on page 27 for more information.		H	0

Field	Field Type	Description	Format	Binary Bytes	Binary Offset
2	sol status	Solution status (see <i>Table 65: Solution Status</i> on page 374)	Enum	4	H
3	pos type	Position type (see <i>Table 66: Position or Velocity Type</i> on page 375)	Enum	4	H+4
4	cutoff	GPS tracking elevation cut-off angle	Float	4	H+8
5	# chans	Number of hardware channels with information to follow	Ulong	4	H+12
6	PRN/slot	Satellite PRN number of range measurement Refer to <i>PRN Numbers</i> on page 46	Short	2	H+16
7	glofreq	(GLONASS Frequency + 7), see <i>GLONASS Slot and Frequency Numbers</i> on page 45	Short	2	H+18
8	ch-tr-status	Channel tracking status (see <i>Table 121: Channel Tracking Status</i> on page 614)	Ulong	4	H+20
9	psr	Pseudorange (m) - if this field is zero but the channel tracking status in the previous field indicates that the card is phase locked and code locked, the pseudorange has not been calculated yet	Double	8	H+24
10	Doppler	Doppler frequency (Hz)	Float	4	H+32
11	C/No	Carrier to noise density ratio (dB-Hz)	Float	4	H+36
12	locktime	Number of seconds of continuous tracking (no cycle slips)	Float	4	H+40
13	psr res	Pseudorange residual from pseudorange position filter (m)	Float	4	H+44
14	reject	Range reject code from pseudorange position filter (see <i>Table 71: Observation Statuses</i> on page 381)	Enum	4	H+48
15	psr weight	Pseudorange filter weighting	Float	4	H+52
16...	Next PRN offset = H+16+(#chans x 40)				
17	xxxx	32-bit CRC (ASCII and Binary only)	Ulong	4	H+16 (#chans x 40)
18	[CR][LF]	Sentence terminator (ASCII only)	-	-	-

3.189 TRANSFERPORTSTATUS

Display the state of the USB transfer port

Platform: PwrPak7

This log displays the current state of the USB transfer port.

Message ID: 2114

Log Type: Asynch

Recommended Input:

```
log transferportstatusa onchanged
```

ASCII Example:

```
#TRANSFERPORTSTATUSA,COM1,0,86.5,UNKNOWN,0,10.551,02100000,4b3f,32768;USBSTICK,HOST*9f7ad7be
```

Field	Field Type	Description	Format	Binary Bytes	Binary Offset
1	TRANSFERPORTSTATUS header	Log header. See <i>Messages</i> on page 27 for more information.	-	H	0
2	USB Detection Type	Type of connection detected See <i>Table 179: USB Detection Type</i> below	Enum	4	H
3	USB Mode	Current USB operation mode See <i>Table 180: USB Mode</i> on the next page	Enum	4	H+4
4	xxxx	32-bit CRC (ASCII and Binary only)	Hex	4	H+8
5	[CR][LF]	Sentence terminator (ASCII only)	-	-	-

Table 179: USB Detection Type

Binary	ASCII	Description
0	NONE	Nothing is detected
1	USBSTICK	A flash drive is detected
2	PC	A computer is detected
3	ERROR	This is an error state

Table 180: USB Mode

Binary	ASCII	Description
0	DEVICE	The USB port is in device mode
1	HOST	The USB port is in host mode
2	OTG	The USB port is in OTG mode
3	INVALID	The USB port is in an invalid mode
4	NONE	The USB port is not in an operation mode
5	TRANSITION	The USB port operation mode is transitioning

3.190 UPTIME

Report the running time of the receiver

Platform: OEM719, OEM729, OEM7500, OEM7600, OEM7700, OEM7720, PwrPak7, SPAN CPT7, SMART7, SMART2

This log reports the number of seconds the receiver's firmware has been running, after the application of power or after the completion of a reset.

Message ID: 1777

Log Type: Polled

Recommended Input:

```
log uptimea once
```

ASCII Example:

```
#UPTIMEA,COM1,0,80.0,FINESTEERING,1928,495123.000,02000020,27d2,32768;151639*013e11a7
```



In this example, 151639 seconds since power-on = 42.1 hours.

Field	Field Type	Description	Format	Binary Bytes	Binary Offset
1	UPTIME header	Log header. See <i>Messages</i> on page 27 for more information.	-	H	0
2	Uptime	The number of seconds the receiver has been running after a power up or reset.	Ulong	4	H
3	xxxx	32-bit CRC (ASCII and Binary only)	Hex	4	H+4
4	[CR][LF]	Sentence terminator (ASCII only)	-	-	-

3.191 USERI2CRESPONSE

Status of USERI2CREAD or USERI2CWRITE Command

Platform: OEM7600, OEM7700, OEM7720

This log reports the status of a previously executed **USERI2CREAD** or **USERI2CWRITE** command. There is one log emitted for each command that is executed.

For the **USERI2CREAD** command (see page 330), this log outputs the data read from the device on the I2C bus and the status of the read operation.

For the **USERI2CWRITE** command (see page 332), the status of the write operation is reported and the data field will always be 0.

Message ID: 2234

Recommended Input:

```
log USERI2CRESPONSE onnew
```

Abbreviated ASCII Example 1:

```
USERI2CREAD 70 4 aabbccdd 12 6789
```

```
<USERI2CRESPONSE COM1 0 84.0 FINESTEERING 1994 257885.895 02000000 e3f6 32768
< 70 aabbccdd OK READ 6789 12 000102030405060708090a0b
```

Abbreviated ASCII Example 2:

```
USERI2CWRITE 70 3 aabbcc 8 0001020304050607 12345
```

```
<USERI2CRESPONSE COM1 0 84.0 FINESTEERING 1994 257885.895 02000000 e3f6 32768
< 70 aabbcc OK WRITE 12345 0
```

Field	Field Type	Description	Format	Binary Bytes	Binary Offset
1	USERI2CRESPONSE header	Log header. See Messages for more information.	-	H	0
2	DeviceAddress	The 7 bit address of the I2C device. Valid values are 0 through 127. For ASCII and Abbreviated commands, this field is a hexadecimal string of two digits. There is no 0x prefix and spaces are not allowed in the string.	Uchar	1 ¹	H
3	RegisterAddress	The actual register address used for the operation. This is a ULONG value in hexadecimal format (without 0x prefix).	Ulong	4	H+4

¹In the binary case, additional bytes of padding are added after this field to maintain 4-byte alignment for the fields that follow.

Field	Field Type	Description	Format	Binary Bytes	Binary Offset
4	ErrorCode	Error code for the operation. See <i>Table 181: Error Code</i> below.	Enum	4	H+8
5	OperationMode	Operation mode code. See <i>Table 182: Operation Mode Code</i> on the next page.	Enum	4	H+12
6	TransactionID	This is the copy of Transaction ID provided to the command.	Ulong	4	H+16
7	ReadDataLength	For a Read operation, this is the actual number of bytes read from the I2C device. For a Write operation, this value is always zero.	Ulong	4	H+20
8	ReadData	For a Read operation, this is the data read from the device. For ASCII logs this field is displayed as a string of hexadecimal digits, with two digits per byte. The first byte retrieved from the I2C device is the first byte displayed and so on. The maximum size of this field is 256 bytes. When ReadDataLength is zero, this field will be empty.	HEXBYTE ARRAY	Y	H+24

Table 181: Error Code

Binary	ASCII	Description
0	OK	I2C transaction is successful
1	IN_PROGRESS	I2C transaction is currently in progress
2	DATA_TRUNCATION	I2C transaction read data was truncated
3	BUS_BUSY	I2C bus is busy
4	NO_DEVICE_REPLY	No device replied to the I2C transaction request
5	BUS_ERROR	I2C bus error or bus arbitration lost
6	TIMEOUT	I2C transaction has timed out
7	UNKNOWN_FAILURE	I2C transaction has an unexplained failure

Table 182: Operation Mode Code

Binary	ASCII	Description
0	NONE	No Operation
1	READ	Read Operation
2	WRITE	Write Operation
3	SHUTDOWN	Shut down Operation

3.192 VALIDMODELS

Valid model information

Platform: OEM719, OEM729, OEM7500, OEM7600, OEM7700, OEM7720, PwrPak7, SPAN CPT7, SMART7, SMART2

This log gives a list of valid authorized models available and expiry date information.

If a model has no expiry date, it reports the year, month and day fields as 0s.

Message ID: 206

Log Type: Asynch

Recommended Input:

```
log validmodelsa once
```

ASCII Example:

```
#VALIDMODELSA,COM1,0,92.0,FINESTEERING,1610,499139.682,02000000,342f,6293;1,"D2LR0RCCR",0,0,0*d0580c1b
```



Use the VALIDMODELS log to output a list of available models for the receiver. Use the **AUTH** command (see page 63), to add a model and the **MODEL** command (see page 188) to change the currently active model. See the **VERSION** log on page 796 for the currently active model

Field	Field type	Description	Format	Binary Bytes	Binary Offset
1	VALIDMODELS header	Log header. See <i>Messages</i> on page 27 for more information.		H	0
2	#mod	Number of models with information to follow	Ulong	4	H
3	model	Model name	String [Max16]	Variable ¹	H+4
4	expyear	Expiry year	Ulong	4	Variable Max: H+20
5	expmonth	Expiry month	Ulong	4	Variable Max: H+24
6	expday	Expiry day	Ulong	4	Variable: Max: H+28

¹In the binary case, each string field needs to be NULL terminated and additional bytes of padding added to maintain 4-byte alignment, up to the maximum defined by the string size. The next defined field starts immediately at the next 4-byte alignment following the NULL.

Field	Field type	Description	Format	Binary Bytes	Binary Offset
7...	Next model offset = $H+4+(\# \text{mod } x \text{ variable } [\text{max}:28])$				
8	xxxx	32-bit CRC (ASCII and Binary only)	Ulong	4	$H+4+(\# \text{mod } x \text{ variable } [\text{max}:28])$
9	[CR][LF]	Sentence terminator (ASCII only)	-	-	-

3.193 VERSION

Version information

Platform: OEM719, OEM729, OEM7500, OEM7600, OEM7700, OEM7720, PwrPak7, SPAN CPT7, SMART7, SMART2

This log contains the version information for all components of a system. A component may be hardware (for example, a receiver or data collector) or firmware in the form of applications or data (for example, data blocks for height models or user applications). See *Table 184: Firmware and Boot Version Field Formats* on page 799 for details on the format of key fields.

See also the **VALIDMODELS** log on page 794.

Message ID: 37

Log Type: Polled

Recommended Input:

log versiona once

Abbreviated ASCII Example:

```
<VERSION USB1 0 72.0 FINESTEERING 2025 247123.828 02000020 3681 14970
< 11
< GPSCARD "FFNRNNCBES1" "BMHR17090005E" "OEM7700-1.00" "OM7CR0500RN0000"
"OM7BR0001RB0000" "2018/Jul/10" "14:37:01"
< OEM7FPGA "" "" "" "OMV070001RN0000" "" "" ""
< WHEELSENSOR "" "" "" "SWS000101RN0000" "" "2018/Jul/10" "14:37:28"
< WIFI "RS9113" "" "" "1.6.8" "" "2018/Jul/10" "14:37:32"
< APPLICATION "" "" "" "EP7AR0500RN0000" "" "2018/Jul/10" "14:37:13"
< DEFAULT_CONFIG "" "" "" "EP7CR0500RN0000" "" "2018/Jul/10" "14:37:23"
< PACKAGE "" "" "" "EP7PR0500RN0000" "" "2018/Jul/10" "14:37:18"
< DB_WWWISO "WWWISO" "0" "" "WMC010201AN0004" "" "2017/Sep/20" "21:00:04"
< ENCLOSURE "" "NMNE17200009B" "" "" "" "" ""
< REGULATORY "US" "" "" "" "" "" ""
< IMUCARD "Epson G320N" "" "" "" "" "" ""
```



The VERSION log is a useful log as a first communication with your receiver. Once connected, using NovAtel Connect or a terminal emulator program, log VERSION and check that the output makes sense. Also, ensure that you have the receiver components you expected.

Field	Field type	Description	Format	Binary Bytes	Binary Offset
1	VERSION header	Log header. See <i>Messages</i> on page 27 for more information.		H	0
2	# comp	Number of components (cards, and so on)	Long	4	H

Field	Field type	Description	Format	Binary Bytes	Binary Offset
3	type	Component type (see <i>Table 183: Component Types</i> on the next page)	Enum	4	H+4
4	model	OEM7 firmware model number e.g., CFNPNNTVN indicates the receiver's current model functionality When the component type is ENCLOSURE, the model specifies the enclosure type.	Char [16]	16	H+8
5	psn	Product serial number	Char [16]	16	H+24
6	hw version	Hardware version in the format: P-R Where P = hardware platform R = hardware revision Example: OEM7700-1.00	Char [16]	16	H+40
7	sw version	Firmware version, see <i>Table 184: Firmware and Boot Version Field Formats</i> on page 799	Char [16]	16	H+56
8	boot version	Boot code version, see <i>Table 184: Firmware and Boot Version Field Formats</i> on page 799	Char [16]	16	H+72
9	comp date	Firmware compile date in the format: YYYY/Mmm/DD Where YYYY = year Mmm = month DD = day (1-31) Example: 2018/Jul/10	Char [12]	12	H+88
10	comp time	Firmware compile time in the format: HH:MM:SS Where: HH = hours MM = minutes SS = seconds Example: 14:37:01	Char [12]	12	H+100
11...	Next component offset = H + 4 + (#comp x 108)				

Field	Field type	Description	Format	Binary Bytes	Binary Offset
12	xxxx	32-bit CRC (ASCII and Binary only)	Ulong	4	H+4+ (#comp x 108)
13	[CR][LF]	Sentence terminator (ASCII only)	-	-	-

Table 183: Component Types

Binary	ASCII	Description
0	UNKNOWN	Unknown component
1	GPSCARD	OEM7 family receiver In an enclosure product this is the receiver card in the enclosure.
2	CONTROLLER	Reserved
3	ENCLOSURE	OEM card enclosure
4-6	Reserved	
7	IMUCARD	IMU integrated in the enclosure
8	USERINFO	Application specific information
12-14	Reserved	
15	WIFI	Wi-Fi radio firmware
16-17	Reserved	
18	RADIO	UHF radio component
19	WWW_CONTENT	Web Server content
20	Regulatory	Regulatory configuration
21	OEM7FPGA	OEM7 FPGA version
22	APPLICATION	Embedded application
23	Package	Package
24	Reserved	
25	DEFAULT_CONFIG	Default configuration data
26	WHEELSENSOR	Wheel sensor in the enclosure
27	EMBEDDED_AUTH	Embedded Auth Code data
981073920 (0x3A7A0000)	DB_HEIGHTMODEL	Height/track model data
981073928 (0x3A7A0008)	DB_WWWISO	Web UI ISO Image
981073930 (0x3A7A000A)	DB_LUA_SCRIPTS	Lua Script ISO Image

Table 184: Firmware and Boot Version Field Formats

Field Format (ASCII)	Description	Example	
NWXZYFFMMRN0000	N = Family Name The Family Name can be: O = OEM	Software Version: OM7CR0500RN0000 Boot Version: OM7BR0001RB0000	In both examples, the Family Name is O .
	WX = Product The Product can be: M7: OEM7 product A7: Agriculture optimized OEM7 product		In both examples, the Product is M7 .
	Y = Image Type The Image Type can be: B: boot code M: main firmware application C: combined main firmware application and user application		In the Software Version example, the Image Type is C . In the Boot Version example, the Image Type is B .
	Z = Signature The Signature can be: R: Officially signed H: High Speed signed		In both examples the Signature is R .
	FF = Feature Release Number		In the Software Version example, the Feature Release Number is 05 . In the Boot Version example, the Feature Release Number is 00 .
	MM = Maintenance Release Number		In both examples, the Maintenance Release Number is 00 .

Field Format (ASCII)	Description	Example	
	R = Release Type The Release Type can be: A: Alpha B: Beta R: Release S: Special E: Engineering Special C: Customer Approved Special		In both examples, the Release Type is R .
	N = Distribution Permit The Distribution Permit can be: N: No restrictions B: Boot Code H: High Speed Build (Requires a permit to use)		In the Software Version example, the Distribution Permit is N . In the Boot Version example, the Distribution Permit is B .
	0000 = Minor Release Indicator		In both examples, the Minor Release Indicator is 0000 .



The firmware version of a receiver is also presented in a short version (e.g. 7.05.04). The short version is the product number, feature release number and maintenance release number separated by dots. For example, the firmware version OM7MR0504RN0000 has a short version of 7.05.04.

3.194 WIFIAPSETTINGS

Display the Wi-Fi access point configuration

Platform: PwrPak7, SMART7-I, SMART7-SI, SMART7-W

Use this log to display the Wi-Fi access point configuration. If the access point is not currently operational, the log reports the access point configuration to be applied the next time the **WIFIMODE AP** or **WIFIMODE CONCURRENT** command is received.



The term passkey and password are the same.

Message ID: 2093

Log Type: Polled

Recommended Input:

LOG WIFIAPSETTINGS

ASCII Example:

```
#WIFIAPSETTINGS SA, COM1, 0, 77.5, FINESTEERING, 2007, 167962.000, 02000000, fc0e, 14693;
"PwrPak7-NMNE16470005M", "12345678", 2P4GHZ, WPA2, CCMP, US, 11, "2d:43:5a:63:79:6f"
*546c6f08
```

Field	Field Type	Description	Format	Binary Bytes	Binary Offset
1	WIFIAPSETTINGS header	Log header. See <i>Messages</i> on page 27 for more information.	-	H	0
2	SSID	SSID of the AP	String [Max 33]	Variable	H
3	passkey	Passkey of the AP	String [Max 65]	Variable	Variable
4	band	Wi-Fi operating band. See <i>Table 185: Wi-Fi Band</i> on the next page.	Enum	4	Variable
5	security protocol	Wireless security protocol. See <i>Table 186: Wi-Fi Security Protocol</i> on the next page.	Enum	4	Variable
6	encryption	Wireless encryption type. See <i>Table 187: Wi-Fi Encryption Type</i> on the next page.	Enum	4	Variable
7	region	Regulatory region. See <i>Table 188: Regulatory Region</i> on page 803.	Enum	4	Variable

Field	Field Type	Description	Format	Binary Bytes	Binary Offset
8	channel	Wireless channel used by access point to communicate with connected clients.	Int	4	Variable
9	BSSID	BSSID of the AP (MAC of the Wi-Fi interface)	String [Max 18]	Variable	Variable
10	xxxx	32-bit CRC (ASCII or Binary only)	Hex	4	Variable
11	[CR][LF]	Sentence terminator (ASCII only)	-	-	-

Table 185: Wi-Fi Band

Binary	ASCII	Description
1	2P4GHZ	2.4 GHz

Table 186: Wi-Fi Security Protocol

Binary	ASCII	Description
1	OPEN	Open network (No security)
2	WPA	Wi-Fi Protected Access
3	WPA2	Wi-Fi Protected Access version 2



NovAtel Wi-Fi access points only support the WPA2 security protocol. As a result, the **WIFIAPSETTINGS** log will only report **WPA2**.

Novatel Wi-Fi Clients support OPEN, WPA, and WPA2 security protocols.

Table 187: Wi-Fi Encryption Type

Binary	ASCII	Description
1	OPEN	Open (no encryption)
2	TKIP	Temporal Key Integrity Protocol (used with WPA)
3	CCMP	AES-based CCMP (Cipher Chaining Message Authentication) used with WPA2



NovAtel Wi-Fi access points only support the WPA2 security protocol. As a result, the **WIFIAPSETTINGS** log will only report **CCMP**.

Table 188: Regulatory Region

Binary	ASCII	Description
0	None	Receiver has not been configured to comply with any regional regulatory requirements. Wireless components (e.g. Wi-Fi) will not operate. Contact NovAtel Customer Support.
1	US	United States
2	EU	Europe
3	AU	Australia
4	JP	Japan
5	NZ	New Zealand
6	BR	Brazil

3.195 WIFINETLIST

Display a list of Wi-Fi networks in range of client

Platform: PwrPak7, SMART7-I, SMART7-SI, SMART7-W

Use this log to display information about Wi-Fi access points detected by the receiver when configured in either Client or Concurrent mode.

Message ID: 2210

Log Type: Asynch

Recommended input:

```
log wifinetlist onchanged
```

ASCII Example:

```
#WIFINETLISTA,COM1,0,73.0,FINESTEERING,1989,422765.530,02000000,9906,32768;1
,"SM7-i NMRT00000001M",-20,7,"aa:bb:cc:dd:ee:01",WPA2*0727340b
```

Field	Field Type	Description	Format	Binary Bytes	Binary Offset
1	WIFINETLIST header	Log header. See <i>Messages</i> on page 27 for more information.	-	H	0
2	num_networks	Number of network records to follow	Ulong	4	H
3	SSID	SSID of scanned access point.	String [Max 33]	variable	H+4
4	RSSI	Absolute value of RSSI (dBm)	Int	4	variable
5	channel	RF channel to use	Ulong	4	variable
6	BSSID	MAC address of the access point.	String [Max 18]	variable	variable
7	security	Security mode of access point. <i>Table 189: Wi-Fi Security Type</i> below	Enum	4	variable

Table 189: Wi-Fi Security Type

Binary	ASCII	Description
1	OPEN	Open network (no security)
2	WPA	Wi-Fi protected access
3	WPA2	Wi-Fi protected access II

3.196 WIFISTATUS

Display status information of receiver Wi-Fi

Platform: PwrPak7, SMART7-I, SMART7-SI, SMART7-W

Use this log to display the current status of a Wi-Fi Client and or Access Point in addition to information about any connected Access Point and or Clients.

Message ID: 2207

Log Type: Asynch

Recommended input:

```
log wifistatus onchanged
```

ASCII Example:

```
#WIFISTATUSA,COM1,0,63.5,UNKNOWN,0,31.682,02440000,c017,32768;CONCURRENT_
OPERATIONAL," PwrPak7-NMND17130002Z",-20,11,"
00:21:66:01:47:BB",WPA2,1,"D4:6E:0E:05:B1:F6"*faee8ed9
```

Field	Field Type	Description	Format	Binary Bytes	Binary Offset
1	WIFISTATUS header	Log header. See <i>Messages</i> on page 27 for more information.	-	H	0
2	status	Wi-Fi operational status. Refer to <i>Table 190: Wi-Fi Status</i> on the next page.	String [Max 33]	Variable	H
3	AP SSID	SSID of connected access point. This field is blank if the client is not connected to an access point.	String [Max 33]	Variable	
4	AP RSSI	Value of RSSI (dBm) of connection to access point. This field is zero if the client is not connected to an access point.	Ulong	4	
5	AP channel	Channel use to connect to access point. This field is zero if the client is not connected to an access point.	Ulong	4	
6	AP BSSID	MAC address of connected access point. This field is blank if the client is not connected to an access point.	Ulong	4	
7	AP security	Security mode of connected access point. See <i>Table 189: Wi-Fi Security Type</i> on the previous page in the WIFINETLIST command (see page 804). The value of this field is only valid if the AP SSID field is not blank.	Enum	4	

Field	Field Type	Description	Format	Binary Bytes	Binary Offset
8	#clients	Number of clients connected to an access point to follow.	Ulong	4	
9	BSSID	MAC address of connected client.	String [Max 18]	Variable	
10...	Next Client				

Table 190: Wi-Fi Status

Binary	ASCII	Description
0	STARTUP	
1	OFF	Wi-Fi hardware is powered off
2	ON	Wi-Fi hardware is powered on but not configured
3	CONFIGURING_ACCESSPOINT	Wi-Fi hardware is being configured as an access point
4	ACCESSPOINT_OPERATIONAL	Wi-Fi hardware is operating as an access point and is ready to accept client connections
5	CONFIGURING_CLIENT	Wi-Fi hardware is being configured as a client station
6	CLIENT_OPERATIONAL	Wi-Fi hardware is operating as a client but is not connected to an access point
7	BOOTING_UP	Wi-Fi hardware is booting up
8	BOOTUP_COMPLETE	Wi-Fi hardware has booted up
9	UPGRADE_REQUIRED	Wi-Fi firmware version does not match required version
10	UPGRADING_FIRMWARE	Wi-Fi firmware is being upgraded
11	UPGRADING_FIRMWARE_10	Wi-Fi firmware update is 10% complete
12	UPGRADING_FIRMWARE_20	Wi-Fi firmware update is 20% complete
13	UPGRADING_FIRMWARE_30	Wi-Fi firmware update is 30% complete
14	UPGRADING_FIRMWARE_40	Wi-Fi firmware update is 40% complete

Binary	ASCII	Description
15	UPGRADING_ FIRMWARE_50	Wi-Fi firmware update is 50% complete
16	UPGRADING_ FIRMWARE_60	Wi-Fi firmware update is 60% complete
17	UPGRADING_ FIRMWARE_70	Wi-Fi firmware update is 70% complete
18	UPGRADING_ FIRMWARE_80	Wi-Fi firmware update is 80% complete
19	UPGRADING_ FIRMWARE_90	Wi-Fi firmware update is 90% complete
20	UPGRADING_ FIRMWARE_ COMPLETE	Wi-Fi firmware update is 100% complete
21	ERROR	An error has occurred
22	CONFIGURING_ CONCURRENT	Wi-Fi hardware is being configured to operate as both an access point and client concurrently
23	CONCURRENT_ OPERATIONAL	Wi-Fi hardware is operating as both an access point and client. The client is not connected to an access point.
24	CONNECTING_TO_AP	Wi-Fi hardware is attempting to connect to an access point
25	CONNECTED_TO_AP	Wi-Fi hardware has successfully connected to an access point
26	CONNECTION_ FAILURE	Wi-Fi client failed to connect to an access point. Possible causes include invalid password provided in the WIFINETCONFIG command (see page 343)
27	CONFIGURING_ NETWORK_ PARAMETERS	Wi-Fi client is configuring its network parameters based on active connection to an access point
28	CONNECTION_ REFUSED	Wi-Fi client failed on initial attempt to connect to an access point due to the connection being actively refused by the access point Possible causes include invalid configuration settings in the WIFINETCONFIG command on page 343
29	PREFERRED_ NETWORK_ MISCONFIGURED	Wi-Fi client cannot connect to preferred access point due to a misconfiguration of network parameters in the WIFINETCONFIG command on page 343
30	CONCURRENT_ CONNECTING_TO_AP	Wi-Fi concurrent client is configuring its network parameters based on active connection to an access point

Binary	ASCII	Description
31	CONCURRENT_ CONFIGURING_ NETWORK_PARAMS	Wi-Fi concurrent client is configuring its network parameters based on active connection to an access point
32	CONCURRENT_ CONNECTED_TO_AP	Wi-Fi concurrent client has successfully connected to an access point
33	DISCONNECTING_ FROM_AP	Wi-Fi client is disconnecting from an access point
34	CONCURRENT_ DISCONNECTING_ FROM_AP	Wi-Fi concurrent is disconnecting from an access point
35	BOOTUP_ CONNECTING_TO_ WIFI_MODULE	
36	BOOTUP_ERROR	

Chapter 4 Agriculture SPAN Commands

The commands used to configure GNSS+INS functions are described in the following sections. For information about other available commands, refer to *Agriculture GNSS Commands* on page 52.

Synchronous Position, Attitude and Navigation (SPAN) technology brings together two different but complementary technologies: Global Navigation Satellite System (GNSS) positioning and inertial navigation. The absolute accuracy of GNSS positioning and the stability of Inertial Measurement Unit (IMU) gyro and accelerometer measurements are tightly coupled to provide an exceptional 3D navigation solution that is stable and continuously available, even through periods when satellite signals are blocked.

4.1 ALIGNMENTMODE

Set the Alignment Mode

Platform: OEM719, OEM729, OEM7500, OEM7600, OEM7700, OEM7720, PwrPak7, SPAN CPT7, SMART7-S, SMART7-SI

Use this command to set the alignment method used to initialize the SPAN system.

The default ALIGNMENTMODE is AUTOMATIC. In this mode, the first available method to align is used.

Sending the ALIGNMENTMODE command manually overrides the AUTOMATIC setting and changes the options available to complete an alignment.

Message ID: 1214

Abbreviated ASCII Syntax:

```
ALIGNMENTMODE mode
```

Abbreviated ASCII Example:

```
ALIGNMENTMODE AIDED_TRANSFER
```

Field	Field Type	ASCII Value	Binary Value	Description	Binary Format	Binary Bytes	Binary Offset
1	ALIGNMENTMODE header	-	-	Command header. See <i>Messages</i> on page 27 for more information.	-	H	0

Field	Field Type	ASCII Value	Binary Value	Description	Binary Format	Binary Bytes	Binary Offset
2	mode	UNAIDED	0	Static coarse alignment or kinematic alignment methods are available.	Enum	4	H
		AIDED_TRANSFER	2	Seed the initial azimuth estimate from the ALIGN solution.			
		AUTOMATIC	3	Seed the full attitude from the ALIGN solution, perform a regular static coarse alignment or perform a kinematic alignment, whichever is possible first.			
		STATIC	4	Static coarse alignment method only.			
		KINEMATIC	5	Kinematic alignment method only.			



If the **ALIGNMENTMODE** selected can use a kinematic alignment (UNAIDED, KINEMATIC or AUTOMATIC), the **SETINSROTATION RBV** command must be sent to the receiver regardless of system configuration and IMU orientation.



NVM Seed injected (see the **INSSEED** command on page 825) and commanded (see **SETINITAZIMUTH** command on page 833) alignments are valid for all alignment modes and will supersede all other options if valid and available.

4.2 CONNECTIMU

Connects an IMU to a Port

Platform: OEM719, OEM729, OEM7500, OEM7600, OEM7700, OEM7720, PwrPak7

Use this command to specify the type of IMU connected to the receiver and the receiver port used by the IMU.

Message ID: 1428

Abbreviated ASCII Syntax:

```
CONNECTIMU IMUPort IMUType
```

Abbreviated ASCII Example:

```
CONNECTIMU COM2 LN200
```

Field	Field Type	ASCII Value	Binary Value	Description	Binary Format	Binary Bytes	Binary Offset
1	CONNECTIMU header	-	-	Command header. See <i>Messages</i> on page 27 for more information.	-	H	0
2	IMUPort	COM1	1	IMU Port is COM port 1	Enum	4	H
		COM2	2	IMU Port is COM port 2			
		COM3	3	IMU Port is COM port 3			
		SPI	7	IMU Port is the SPI port			
		COM4	19	IMU Port is COM port 4			
		COM5	31	IMU Port is COM port 5			
3	IMUType	See <i>Table 191: IMU Type</i> on the next page		IMU Type	Enum	4	H+4



SPI is available only on the OEM7500, OEM7600, OEM7700, and OEM7720.



COM4 and COM5 are available only on the OEM7600, OEM7700 and OEM7720.



The IMU-ISA-100C, IMU-FSAS, IMU-HG1900, IMU-LN200, IMU- μ IMU, IMU-CPT and IMU-KVH1750 use RS-422 protocol and must be connected to a receiver port that is configured to use RS-422. Refer to for information about which receiver ports support RS-422 and instructions for enabling RS-422.

Table 191: IMU Type

Binary	ASCII	Description
0	UNKNOWN	Unknown IMU type (default)
1	HG1700_AG11	Honeywell HG1700 AG11
4	HG1700_AG17	Honeywell HG1700 AG17
5	HG1900_CA29	Honeywell HG1900 CA29
8	LN200	Northrop Grumman LN200/LN200C
11	HG1700_AG58	Honeywell HG1700 AG58
12	HG1700_AG62	Honeywell HG1700 AG62
13	IMAR_FSAS	iMAR iIMU-FSAS
16	KVH_COTS	KVH CPT IMU
20	HG1930_AA99	Honeywell HG1930 AA99
26	ISA100C	Northrop Grumman Litef ISA-100C
27	HG1900_CA50	Honeywell HG1900 CA50
28	HG1930_CA50	Honeywell HG1930 CA50
31	ADIS16488	Analog Devices ADIS16488
32	STIM300	Sensoror STIM300
33	KVH_1750	KVH1750 IMU
41	EPSON_G320	Epson G320N
52	LITEF_MICROIMU	Northrop Grumman Litef μ IMU-IC
56	STIM300D	Sensoror STIM300, Direct Connection
58	HG4930_AN01	Honeywell HG4930 AN01
61	EPSON_G370	Epson G370N
62	EPSON_G320_200HZ	Epson G320N – 200 Hz



The IMU Type field also supports the legacy ASCII values that contain the "IMU_" prefix. For example, *LN200* or *IMU_LN200*. IMUs recently added as SPAN supported devices, such as the LITEF_MICROIMU and STIM300D, do not support the "IMU_" prefix.



Values not shown in this table are reserved.

4.3 EXTERNALPVAS

Enter PVA Update

Platform: OEM719, OEM729, OEM7500, OEM7600, OEM7700, OEM7720, PwrPak7, SPAN CPT7, SMART7-S, SMART7-SI



This command should only be used by advanced users of GNSS+INS.



The standard deviations entered using this command must be representative of actual input error.



The **EXTERNALPVAS** command uses a short header if the command is entered in ASCII or Binary.

This command allows the user to provide their own update for INS in full position, velocity, attitude and other updates, and in any combination. The user can also provide height or attitude only updates, along with Zero Velocity Updates (ZUPTs). The position and velocity updates can be entered in local level or ECEF.

The **EXTERNALPVAS** command is designed to provide a method for additional sensor information to be input into the SPAN filter, specifically during GNSS denied environments. This will provide a method to constrain the error growth that is typical in an Inertial Kalman Filter when GNSS observations are unavailable (environments such as: urban canyon, tunnels, jamming etc.). It is important to ensure that the external update and its corresponding standard deviations are accurate and input with minimal latency to provide optimal effectiveness. Entering an external update or its standard deviation inappropriately may have an adverse effect on the SPAN solution.



The default input frame is ECEF. Updates are entered in ECEF unless Local Level is specified using the OptionsMask parameter.

Message ID: 1463

Abbreviated ASCII Syntax:

```
EXTERNALPVAS Position1 Position2 Position3 Velocity1 Velocity2 Velocity3
Attitude1 Attitude2 Attitude3 PosStdDev1 PosStdDev2 PosStdDev3 VelStdDev1
VelStdDev2 VelStdDev3 AttStdDev1 AttStdDev2 AttStdDev3 UpdateMask
OptionsMask
```

Abbreviated ASCII Example: (Local Level Velocity Update)

```
EXTERNALPVAS 0.0 0.0 0.0 0.4502 10.54 -0.09598 0.0 0.0 0.0 0.0 0.0 0.0 0.01
0.01 0.01 0.0 0.0 0.0 4000 10
```

Full ASCII Example: (Local Level Velocity Update)

```
%EXTERNALPVASA,2051,493713.000;0.00000000000,0.00000000000,0.00000000000,
0.1333,17.1424,-0.3311,0.000000000,0.000000000,0.000000000,0.0000,0.0000,
0.0000,0.0119,0.0096,0.0132,0.0000,0.0000,0.0000,00004000,00000010*edced535
```

Field	Field Type	ASCII Value	Binary Value	Description	Binary Format	Binary Bytes	Binary Offset
1	EXTERNALPVAS header	-	-	Command header. See <i>Messages</i> on page 27 for more information.	-	H	0
2	Position1			Latitude (degrees), ECEF X-coordinate (m) or X relative coordinate (m)	Double	8	H
3	Position2			Longitude (degrees), ECEF Y-coordinate (m) or Y relative coordinate (m)	Double	8	H+8
4	Position3			Height, ECEF Z-coordinate or Z relative coordinate (m)	Double	8	H+16
5	Velocity1			North velocity or velocity along the X-axis (m/s)	Float	4	H+24
6	Velocity2			East velocity or velocity along the Y-axis (m/s)	Float	4	H+28
7	Velocity3			Up velocity or velocity along the Z-axis (m/s)	Float	4	H+32
8	Attitude1			Pitch – Local Level to SPAN User Output Frame or relative delta from SPAN User Output Frame (degrees)	Float	4	H+36
9	Attitude2			Roll – Local Level to SPAN User Output Frame or relative delta from SPAN User Output Frame (degrees)	Float	4	H+40
10	Attitude3			Azimuth – Local Level to SPAN User Output Frame or relative delta from SPAN User Output Frame (degrees)	Float	4	H+44
11	PosStdDev1			Position1 standard deviation (m)	Float	4	H+48

Field	Field Type	ASCII Value	Binary Value	Description	Binary Format	Binary Bytes	Binary Offset
12	PosStdDev2			Position2 standard deviation (m)	Float	4	H+52
13	PosStdDev3			Position3 standard deviation (m)	Float	4	H+56
14	VelStdDev1			Velocity1 standard deviation (m/s)	Float	4	H+60
15	VelStdDev2			Velocity2 standard deviation (m/s)	Float	4	H+64
16	VelStdDev3			Velocity3 standard deviation (m/s)	Float	4	H+68
17	AttStdDev1			Attitude1 standard deviation (degrees)	Float	4	H+72
18	AttStdDev2			Attitude2 standard deviation (degrees)	Float	4	H+76
19	AttStdDev3			Attitude3 standard deviation (degrees)	Float	4	H+80
20	UpdateMask			<p>This mask selects which updates are applied. Setting a bit applies the update. More than one update can be applied at one time.</p> <p>See <i>Table 192: EXTERNALPVAS Updates Mask</i> on the next page for the external update bits that can be used.</p>	HEX Ulong	4	H+84
21	OptionsMask			<p>This mask selects the update options for various updates, such as using an ECEF or Local Level system for the position updates.</p> <p>See <i>Table 193: EXTERNALPVAS Options Mask</i> on page 818 for details.</p>	HEX Ulong	4	H+88

Table 192: EXTERNALPVAS Updates Mask

Bit	Mask	Description
0	0x00001	Reserved
1	0x00002	Reserved
2	0x00004	ZUPT Update. No fields are required in the EXTERNALPVAS command for this update.
3	0x00008	Reserved
4	0x00010	Reserved
5	0x00020	External Position Update. This update is entered using Position1 to Position3 in the EXTERNALPVAS command.
6	0x00040	Reserved
7	0x00080	Reserved
8	0x00100	Reserved
9	0x00200	Reserved
10	0x00400	Reserved
11	0x00800	Reserved
12	0x01000	Reserved
13	0x02000	Reserved
14	0x04000	External Velocity Update. This update is entered using Velocity1 to Velocity3 in the EXTERNALPVAS command.
15	0x08000	External Attitude Update. This update is entered using Attitude1 to Attitude3 in the EXTERNALPVAS command.
16	0x10000	External Heading Update. This update is entered using Attitude3 in the EXTERNALPVAS command.
17	0x20000	External Height Update. This update is entered using Position3 in the EXTERNALPVAS command.



If both the External Position Update and External Height Update bits are set, only the External Position Update will be applied.

If both the External Attitude Update and External Heading Update bits are set, only the External Attitude Update will be applied.

Table 193: EXTERNALPVAS Options Mask

Bit	Mask	Description	Range Value
0	0x00000001	Reserved	
1	0x00000002	Reserved	
2-3	0x0000000C	Position Input Frame	00 - ECEF
			01 - LLH
4-5	0x00000030	Velocity Input Frame	00 - ECEF
			01 - LLH
6	0x00000040	Position Update Type	0 - Absolute
			1 - Relative
7	0x00000080	Attitude Update Type	0 - Absolute
			1 - Relative

4.4 INSALIGNCONFIG

Configure ALIGN Parameters for SPAN Receiver

Platform: OEM719, OEM729, OEM7500, OEM7600, OEM7700, OEM7720, PwrPak7, SPAN CPT7, SMART7-S, SMART7-SI

Use the **INSALIGNCONFIG** command to configure ALIGN for a SPAN master receiver to a secondary rover receiver. The command will configure the port on the master and rover and setup corrections at the desired rate. It also attempts to re-establish these corrections should they stop.



Important

- This command must be used to define the ALIGN communication between the receivers that SPAN is to configure.
- When using ICOM ports, the Ethernet settings on the SPAN master and rover receiver must be manually configured.
- The master and rover ports must be the same interface type (i.e. Serial to Serial or Ethernet to Ethernet).
- The **INSALIGNCONFIG** command can be used to set the output rate for dual antenna receivers (e.g. OEM7720). In these cases, the port configuration fields are ignored.

Message ID: 2163

Abbreviated ASCII Syntax:

```
INSALIGNCONFIG masterport [roverport] [baudrate] [outputrate]
```

Abbreviated ASCII Example:

```
INSALIGNCONFIG COM1 COM2 230400 5
```

Field	Field Type	ASCII Value	Binary Value	Description	Format	Binary Bytes	Binary Offset
1	INSALIGNCONFIG header	-	-	Command header. See <i>Messages</i> on page 27 for more information.	-	H	0

Field	Field Type	ASCII Value	Binary Value	Description	Format	Binary Bytes	Binary Offset
2	masterport	NOPORT	0	Specify which COM port on the master receiver to use to communicate with an external ALIGN capable receiver. Selecting NOPORT disables automatic dual antenna configuration.	Enum	4	H
		COM1	1				
		COM2	2				
		COM3	3				
		COM4	19				
		COM5	31				
		ICOM1	23				
		ICOM2	24				
		ICOM3	25				
		ICOM4	29				
		ICOM5	46				
		ICOM6	47				
ICOM7	48						
3	roverport	COM1	1	Specify which rover COM port is connected to the master receiver (Default = COM2)	Enum	4	H+4
		COM2	2				
		COM3	3				
		COM4	19				
		COM5	31				
		ICOM1	23				
		ICOM2	24				
		ICOM3	25				
		ICOM4	29				
		ICOM5	46				
		ICOM6	47				
ICOM7	48						
4	baudrate	57600, 115200, 230400, or 460800		Baud rate for communication (Default = 230400)	Ulong	4	H+8

Field	Field Type	ASCII Value	Binary Value	Description	Format	Binary Bytes	Binary Offset
5	outputrate	1, 2, 4, 5, 10		The data rate, in Hz, in which ALIGN will be output (Default = 1 Hz)	Ulong	4	H+12
6	Reserved	-		Reserved	Ulong	4	H+16



The SPAN filter only requires ALIGN updates at 1 Hz. Increasing the output rate (using the *outputrate* field) does not increase performance, it only provides ALIGN logs at higher rates.

4.5 INSCALIBRATE

Initiate calibration of the INS offsets

Platform: OEM719, OEM729, OEM7500, OEM7600, OEM7700, OEM7720, PwrPak7, SPAN CPT7, SMART7-S, SMART7-SI

Use this command to initiate the calibration of INS offsets.



The RBV calibration requires a valid RBV estimate to be entered prior to initializing the calibration. See the **SETINSROTATION** command on page 835 for details on entering a RBV estimate.



For optimal SPAN performance when using Dual Antenna with SPAN, an ALIGN offset calibration is required for each unique installation. This calibration refines the IMU to antenna baseline angular offset from the initial estimate derived from the input lever arms.

Message ID: 1882

Abbreviated ASCII Syntax:

```
INSCALIBRATE Offset [Trigger] [SDThreshold]
```

Abbreviated ASCII Example:

```
INSCALIBRATE RBV NEW 1.0
```

Field	Field Type	ASCII Value	Binary Value	Description	Binary Format	Binary Bytes	Binary Offset
1	INSCALIBRATE header	-	-	Command header. See <i>Messages</i> on page 27 for more information.	-	H	0

Field	Field Type	ASCII Value	Binary Value	Description	Binary Format	Binary Bytes	Binary Offset
2	Offset	ANT1	1	Use this option to set the INS calibration offset from the IMU to the primary GNSS antenna Note: The ANT1 option is available only on IMU Grade 2 or higher IMUs. See Models and Features in the OEM7 SPAN Installation and Operation User Manual .	Enum	4	H
		ALIGN	8	Use this option to set the INS calibration offset from the IMU Body frame to ALIGN frame rotation.			
		RBV	11	Use this option to set the INS calibration offset from the IMU Body frame to Vehicle frame rotation.			
3	Trigger	STOP	0	Ends the INS calibration and uses the current estimate for the RBV offsets	Enum	4	H+4
		NEW	1	Begins a new single line calibration, overwriting any previous input or cumulative average offset values			
		ADD	2	Adds a new path. Only valid for multi-path RBV calibrations			
		RESET	3	Resets the calibration process and restores the RBV offsets to previous user input values			
4	SDThreshold			Standard Deviation Threshold (default for lever arm calibration = 0.10 m) (default for RBV calibration = 0.5 degrees)	Float	4	H+8

4.6 INSCOMMAND

INS Control Command

Platform: OEM719, OEM729, OEM7500, OEM7600, OEM7700, OEM7720, PwrPak7, SPAN CPT7, SMART7-S, SMART7-SI

Use this command to enable or disable INS. When INS is disabled, no INS position, velocity or attitude is output (however IMU data is still available). Also, INS aiding of tracking reacquisition is disabled. If the command is used to disable INS and then re-enable it, the INS system has to go through its alignment procedure (equivalent to issuing a **RESET** command). See the relevant SPAN User Manual for information about the SPAN alignment procedures.

Message ID: 379

Abbreviated ASCII Syntax:

```
INSCOMMAND action
```

Abbreviated ASCII Example:

```
INSCOMMAND ENABLE
```

Field	Field Type	ASCII Value	Binary Value	Description	Binary Format	Binary Bytes	Binary Offset
1	INS COMMAND header	-	-	Command header. See <i>Messages</i> on page 27 for more information.	-	H	0
2	Action	RESET	0	Resets the GNSS/INS alignment without clearing the INS biases.	Enum	4	H
		DISABLE	1	Disables INS navigation.			
		ENABLE	2	Enables INS navigation where alignment initialization starts again if the Action parameter was previously set to DISABLE.			
		START_NO_TIME	3	Raw IMU data will begin to flow upon system startup. IMU data collection can begin before the receiver has a GNSS solution. (default)			
		START_FINE_TIME	4	RAWIMU data will only be output after the system reaches FINESTEERING.			
RESTART	5	Resets the GNSS/INS alignment and clears the INS biases.					

4.7 INSSEED

INS Seed Configuration

Platform: OEM719, OEM729, OEM7500, OEM7600, OEM7700, OEM7720, PwrPak7, SPAN CPT7, SMART7-S, SMART7-SI

This command enables or disables the saving and restoration of the last known SPAN solution from NVM.

Message ID: 1906

Abbreviated ASCII Syntax:

```
INSSEED Command [Validation]
```

Abbreviated ASCII Example:

```
INSSEED ENABLE
```

Field	Field Type	ASCII Value	Binary Value	Description	Binary Format	Binary Bytes	Binary Offset
1	INSSEED Header	-	-	Command header. See <i>Messages</i> on page 27 for more information.	-	H	0
2	Command	DISABLE	0	Disable the INS seed functionality	Enum	4	H
		ENABLE	1	Enable the INS seed functionality			
		CLEAR	2	Clear the currently saved seed value so it will not be used until re-saved			

Field	Field Type	ASCII Value	Binary Value	Description	Binary Format	Binary Bytes	Binary Offset
3	Validation	VALIDATE	0	Validate INS Seed data using GNSS solution before injecting (default)	Enum	4	H+4
		INJECT	1	Force an NVM seed value (if available) to be used, without any validation. <div style="border: 1px solid black; padding: 5px; margin-top: 10px;">  <p>Using this option to force the seed to be used can result in an unstable INS solution if the vehicle has moved. For advanced users only.</p> </div>			
4	Reserved				Ulong	4	H+8
5	Reserved				Ulong	4	H+12

4.8 INSTHRESHOLDS

Change the INS_HIGH_VARIANCE Threshold

Platform: OEM719, OEM729, OEM7500, OEM7600, OEM7700, OEM7720, PwrPak7, SPAN CPT7, SMART7-S, SMART7-SI



This command should only be used by advanced users of GNSS+INS.

The **INSTHRESHOLDS** command allows you to customize the criteria by which the system reports the inertial solution status. This criteria is used to determine whether the solution status is reported as INS_SOLUTION_GOOD or INS_HIGH_VARIANCE.

This command is useful in situations where system dynamics are known to be challenging.

Message ID: 1448

Abbreviated ASCII Syntax:

```
INSTHRESHOLDS ThresholdConfiguration
```

Abbreviated ASCII Example:

```
INSTHRESHOLDS DEFAULT
```

Field	Field Type	ASCII Value	Binary Value	Description	Binary Format	Binary Bytes	Binary Offset
1	INSTHRESHOLDS header	-	-	Command header. See <i>Messages</i> on page 27 for more information.	-	H	0
2	Threshold Configuration	DEFAULT	0	Standard INS status threshold settings	Enum	4	H
		LOW	1	Low INS status threshold settings (only checks the Attitude standard deviation)			
3	Reserved				Double	8	H+4
4	Reserved				Double	8	H+12
5	Reserved				Double	8	H+20

4.9 RELINSAUTOMATION

Enables Relative INS on the Rover

Platform: OEM719, OEM729, OEM7500, OEM7600, OEM7700, OEM7720, PwrPak7, SPAN CPT7, SMART7-S, SMART7-SI

Use this command to configure the Relative INS plug and play feature on the rover receiver. RELINSAUTOMATION enables/disables the plug and play feature, sets the rover COM port to which the master receiver is connected, sets the baud rate for communication, sets the correction transfer rate and enables/disables sending the HEADINGEXTB/HEADINGEXT2B log back to the master receiver.

On issuing this command at the rover receiver, the rover will automatically sync with the master receiver and configure it to send corrections at the specified baud rate and specified data rate.



The recommended method for configuring Relative INS is to use the **RELINSCONFIG** command (see page 830).



This command should only be issued at the rover receiver.



if the rover receiver is not connected to the master receiver using a serial COM port, use the **RELINSCONFIG** command (see page 830).



To use the **RELINSAUTOMATION** command, the receiver requires a model with the INS Mode set to **R**.

Message ID: 1763

Abbreviated ASCII Syntax:

```
RELINSAUTOMATION option [comport] [baudrate] [datarate] [headingextboption]
```

Abbreviated ASCII Example:

```
RELINSAUTOMATION enable com2 230400 10 on
```

Field	Field Type	ASCII Value	Binary Value	Description	Binary Format	Binary Bytes	Binary Offset
1	RELINS AUTOMATION header	-	-	Command header. See <i>Messages</i> on page 27 for more information.	-	H	0
2	option	ENABLE	0	Enables or disables the plug and play feature.	Enum	4	H
		DISABLE	1				

Field	Field Type	ASCII Value	Binary Value	Description	Binary Format	Binary Bytes	Binary Offset
3	comport	COM1	1	The COM port on the rover receiver to which the master receiver is connected. (default = COM2)	Enum	4	H+4
		COM2	2				
		COM3	3				
4	baudrate	9600, 19200, 38400, 57600, 115200, 230400, 460800		The baud rate used for communication between the master and rover receivers.	Ulong	4	H+8
5	datarate	1, 2, 4, 5, 10 or 20 Hz		The rate at which corrections are transferred between the receivers. (default = 10 Hz)	Ulong	4	H+12
6	headingextb option	ON OFF		Enables or disables sending the HEADINGEXTB/HEADINGEXT2B log back to the master receiver. (default = ON)	Enum	4	H+16

4.10 RELINSCONFIG

Configure Relative INS

Platform: OEM719, OEM729, OEM7500, OEM7600, OEM7700, OEM7720, PwrPak7, SPAN CPT7, SMART7-S, SMART7-SI

Use this command to configure Relative INS on this receiver.



To use the **RELINSCONFIG** command, the receiver requires a model with the INS Mode set to **R**.

Message ID: 1797

Abbreviated ASCII Syntax:

```
RELINSCONFIG enable rxtype [port] [baud] [rateinhz]
```

Abbreviated ASCII Example:

```
RELINSCONFIG ENABLE ROVER COM2 230400 10
```

Field	Field Type	ASCII Value	Binary Value	Description	Binary Format	Binary Bytes	Binary Offset
1	RELINSCONFIG header	-	-	Command header. See <i>Messages</i> on page 27 for more information.	-	H	0
2	enable	DISABLE	0	Enables or disables the Relative INS functionality.	Enum	4	H
		ENABLE	1				
3	rxtype	ROVER	1	Defines the receiver as the master or rover in a Relative INS configuration.	Enum	4	H+4
		MASTER	2				
4	port	See <i>Table 194: COM Ports</i> on the next page		Communication port used to communicate with the other receiver. (default = COM2)	Enum	4	H+8
5	baud	9600, 19200, 38400, 57600, 115200, 230400, 460800		The baud rate used for communication between the master and rover receivers. (default = 230400)	Ulong	4	H+12
6	rateinhz	1, 2, 4, 5, 10 or 20 Hz		The rate at which corrections are transferred between the receivers. (default = 10 Hz)	Ulong	4	H+16

Table 194: COM Ports

Decimal	ASCII	Description
1	COM1	COM port 1
2	COM2	COM port 2
3	COM3	COM port 3
13	USB1	USB port 1
14	USB2	USB port 2
15	USB3	USB port 3
19	COM4	COM port 4
23	ICOM1	IP virtual COM port 1
24	ICOM2	IP virtual COM port 2
25	ICOM3	IP virtual COM port 3
29	ICOM4	IP virtual COM port 4
31	COM5	COM port 5
46	ICOM5	IP virtual COM port 5
47	ICOM6	IP virtual COM port 6
48	ICOM7	IP virtual COM port 7
49	SCOM1	Scripted application COM port 1
50	SCOM2	Scripted application COM port 2
51	SCOM3	Scripted application COM port 3
52	SCOM4	Scripted application COM port 4

4.11 SETALIGNMENTVEL

Set the Minimum Kinematic Alignment Velocity

Platform: OEM719, OEM729, OEM7500, OEM7600, OEM7700, OEM7720, PwrPak7, SPAN CPT7, SMART7-S, SMART7-SI

Use the **SETALIGNMENTVEL** command to adjust the minimum required velocity for a kinematic alignment.

Useful in cases, such as helicopters, where alignment velocity should be increased to prevent a poor alignment before the vehicle/aircraft is able to flight straight and level.

Message ID: 1397

Abbreviated ASCII Syntax:

```
SETALIGNMENTVEL velocity
```

Abbreviated ASCII Example

```
SETALIGNMENTVEL 5.0
```

Field	Field Type	ASCII Value	Binary Value	Description	Binary Format	Binary Bytes	Binary Offset
1	SETALIGNMENTVEL header	-	-	Command header. See <i>Messages</i> on page 27 for more information.	-	H	0
2	Velocity	Minimum: 0.2 m/s (Default is 5 m/s)		The minimum velocity, in m/s, required to kinematically align.	Double	8	H

4.12 SETINITAZIMUTH

Set Initial Azimuth and Standard Deviation

Platform: OEM719, OEM729, OEM7500, OEM7600, OEM7700, OEM7720, PwrPak7, SPAN CPT7, SMART7-S, SMART7-SI

Use this command to start SPAN operation with a previously known azimuth. Azimuth is the weakest component of a coarse alignment and is also the easiest to know from an external source (i.e., like the azimuth of roadway). When using this command, SPAN operation through alignment will appear the same as with a usual coarse alignment. Roll and pitch is determined using averaged gyro and accelerometer measurements. The input azimuth is used rather than what is computed by the normal coarse alignment routine.

- Input azimuth values must be accurate for good system performance.
- Sending **SETINITAZIMUTH** resets the SPAN filter. Following realignment, vehicle dynamics are required for the filter to re-converge. Bridging performance is poor before filter convergence.
- The entered azimuth angle is with respect to the configured output frame. This is generally the vehicle frame unless a User Frame offset has been configured using the **SETINSROTATION** command (see page 835). All offsets should be entered before entering the **SETINITAZIMUTH** command.
- This command is not save configurable and must be re-entered after each start-up. The command can be entered at any time and will be used automatically when the system is ready to begin alignment.



Azimuth is positive in a clockwise direction when looking towards the z-axis origin.

Message ID: 863

Abbreviated ASCII Syntax:

```
SETINITAZIMUTH azimuth azSTD
```

Abbreviated ASCII Example:

```
SETINITAZIMUTH 90 5
```

Field	Field Type	ASCII Value	Binary Value	Description	Binary Format	Binary Bytes	Binary Offset
1	SETINITAZIMUTH header	-	-	Command header. See <i>Messages</i> on page 27 for more information.	-	H	0
2	azimuth	0 to 360		Input azimuth angle (degrees)	Double	8	H
3	azSTD	1 to 25		Input azimuth standard deviation angle (degrees)	Float	4	H+8

4.13 SETINSPROFILE

Sets filter behavior depending on system environment

Platform: OEM719, OEM729, OEM7500, OEM7600, OEM7700, OEM7720, PwrPak7, SPAN CPT7, SMART7-S, SMART7-SI

This command sets specific filter behavior depending on the environment the system is installed in. The DEFAULT profile is the legacy setting from earlier SPAN products. The other profiles make changes specific to that environment.

See the [OEM7 SPAN Installation and Operation User Manual](#) for a detailed description of each profile's effect.

Message ID: 1944

Abbreviated ASCII Syntax:

```
SETINSPROFILE profile
```

Abbreviated ASCII Example:

```
SETINSPROFILE LAND_BASIC
```

Field	Field Type	ASCII Value	Binary Value	Description	Binary Format	Binary Bytes	Binary Offset
1	SETINS PROFILE Header	-	-	Command header. See <i>Messages</i> on page 27 for more information.	-	H	0
2	Profile	Default	0	Default INS profile with standard SPAN behavior.	Enum	4	H
		LAND	1	INS profile for land vehicles			
		MARINE	2	INS profile for marine vehicles			
		FIXEDWING	3	INS profile for fixed wing aircraft			
		FOOT	4	INS profiles for walking/backpack applications			
		VTOL	5	INS profile for vertical takeoff and landing vehicles (UAVs, helicopters, etc.)			
		RAIL	6	INS profile for trains			
AGRICULTURE	7	INS profile for agriculture applications					

4.14 SETINSROTATION

Specifies rotational offsets between the IMU frame and other reference frames

Platform: OEM719, OEM729, OEM7500, OEM7600, OEM7700, OEM7720, PwrPak7, SPAN CPT7, SMART7-S, SMART7-SI

Use the **SETINSROTATION** command to specify rotational offsets between the IMU frame and other reference frames, such as the vehicle frame or an ALIGN baseline. Offsets must be entered as the rotation from the IMU body frame, to the frame of interest. The order of rotations is Z, X, Y. All rotations are right handed.



It is very important to follow the order of rotations (Z, X, Y) when determining the rotations from IMU body frame to frame of interest.



To specify translational offsets between frames, see the **SETINSTRANSULATION** command on page 838.

Message ID: 1921

Abbreviated ASCII Syntax:

```
SETINSROTATION INSRotation XRotation YRotation ZRotation [XRotationSD]
[YRotationSD] [ZRotationSD]
```

Abbreviated ASCII Example:

```
SETINSROTATION RBV 0 0 90 0.0 0.0 0.0
```

Field	Field Type	ASCII Value	Binary Value	Description	Binary Format	Binary Bytes	Binary Offset
1	SETINSROTATION Header	-	-	Command header. See <i>Messages</i> on page 27 for more information.	-	H	0
2	INS Rotation	<i>Table 195: Rotational Offset Types on the next page</i>		Rotational offset to be set.	Enum	4	H
3	XRotation	±180		X rotation offset from IMU origin (degrees)	Float	4	H+4
4	YRotation	±180		Y rotation offset from IMU origin (degrees)	Float	4	H+8

Field	Field Type	ASCII Value	Binary Value	Description	Binary Format	Binary Bytes	Binary Offset
5	ZRotation	±180		Z rotation offset from IMU origin (degrees)	Float	4	H+12
6	XRotationSD	0 to 45		Optional X rotation offset standard deviation (degrees) Default: 0.0	Float	4	H+16
7	YRotationSD	0 to 45		Optional Y translation offset standard deviation (degrees) Default: 0.0	Float	4	H+20
8	ZRotationSD	0 to 45		Optional Z translation offset standard deviation (degrees) Default: 0.0	Float	4	H+24
9	Reserved				Long	4	H+28

Table 195: Rotational Offset Types

ASCII Value	Binary Value	Description
USER	4	Rotation from the IMU body frame to the user output frame. This offset shifts the attitude information in the INSPVA, INSPOS, INSVEL, INSATT, and INSSPD logs, along with their short header and extended versions.
MARK1	5	Rotation from the IMU body frame to the desired output for MARK1. This offset rotates the attitude information in the MARK1PVA log.
MARK2	6	Rotation from the IMU body frame to the desired output for MARK2. This offset rotates the attitude information in the MARK2PVA log.
ALIGN	8	Rotation from the IMU body frame to an ALIGN dual antenna solution. <div style="border: 1px solid black; padding: 5px; margin-top: 10px;">  When using a dual antenna ALIGN solution with SPAN, this offset will be calculated automatically if translational offsets to both the primary and secondary GNSS antennas are provided using the SETINSTRANSLATION command on page 838. </div>
MARK3	9	Rotation from the IMU body frame to the desired output for MARK3. This offset rotates the attitude information in the MARK3PVA log.

ASCII Value	Binary Value	Description
MARK4	10	Rotation from the IMU body frame to the desired output for MARK4. This offset rotates the attitude information in the MARK4PVA log.
RBV	11	Rotation from the IMU body frame to the vehicle frame.
RBM	12	Rotation from the IMU body frame to the gimbal mount body frame.

4.15 SETINSTRANSALATION

Specifies translational offsets between the IMU frame and other reference frames

Platform: OEM719, OEM729, OEM7500, OEM7600, OEM7700, OEM7720, PwrPak7, SPAN CPT7, SMART7-S, SMART7-SI

Use the **SETINSTRANSALATION** command to specify translational offsets between the IMU frame and other reference frames, including GNSS antennas or the desired output frame. Offsets must be entered as the vector from the IMU, to the frame or position of interest. Offsets can be entered either in the IMU body frame, or the vehicle frame; offsets in the vehicle frame will be automatically rotated into the IMU body frame using the best available IMU Body to Vehicle Rotation (RBV).

For details on entering the RBV rotation or other angular offsets, see the **SETINSROTATION** command on page 835.

Message ID: 1920

Abbreviated ASCII Syntax:

```
SETINSTRANSALATION INsTranslation XTranslation YTranslation ZTranslation
[XTranslationSD] [YTranslationSD] [ZTranslationSD] [InputFrame]
```

Abbreviated ASCII Example:

```
SETINSTRANSALATION USER 1.0 2.0 3.0 0.05 0.05 0.05 VEHICLE
```

Field	Field Type	ASCII Value	Binary Value	Description	Binary Format	Binary Bytes	Binary Offset
1	SETINS TRANSLATION Header	-	-	Command header. See <i>Messages</i> on page 27 for more information.	-	H	0
2	InsTranslation	See Table 196: <i>Translation Offset Types</i> on the next page		Translation offset to be set	Enum	4	H
3	XTranslation	±100		X translation offset from IMU origin (m)	Float	4	H+4
4	YTranslation	±100		Y translation offset from IMU origin (m)	Float	4	H+8
5	ZTranslation	±100		Z translation offset from IMU origin (m)	Float	4	H+12
6	XTranslationSD	0 to 10		Optional X translation offset standard deviation (m)	Float	4	H+16

Field	Field Type	ASCII Value	Binary Value	Description	Binary Format	Binary Bytes	Binary Offset
7	YTranslationSD	0 to 10		Optional Y translation offset standard deviation (m)	Float	4	H+20
8	ZTranslationSD	0 to 10		Optional Z translation offset standard deviation (m)	Float	4	H+24
9	InputFrame	<i>Table 197: Translation Input Frame on the next page</i>		Optional input frame for translation offset values	Enum	4	H+48



For the ANT1, ANT2, EXTERNAL and GIMBAL translations, the standard deviation defaults are set to 10% of the translation value (up to a max of 10 meters).



Large standard deviations can lead to an inaccurate position solution. Therefore, it is highly recommended to measure translation offsets as accurately as possible and to manually enter translation offset standard deviations that reflect that accuracy.

Table 196: Translation Offset Types

ASCII Value	Binary Value	Description
ANT1	1	Offset from the IMU center of navigation to the phase center of the primary GNSS antenna.
ANT2	2	Offset from the IMU center of navigation to the phase center of the secondary GNSS antenna.
EXTERNAL	3	Offset from the IMU center of navigation to the external position source location. This offset type is for use with the EXTERNALPVAS command (see page 814).
USER	4	Translation from the IMU center of navigation to the user output location. This offset shifts the position and velocity information in the INSPVA, INSPOS, INSVEL, INSATT, and INSSPD logs, along with their short header and extended versions.
MARK1	5	Translation from the IMU center of navigation to the MARK1 output location. This offset shifts the position and velocity information in the MARK1PVA log.

ASCII Value	Binary Value	Description
MARK2	6	Translation from the IMU center of navigation to the MARK2 output location. This offset shifts the position and velocity information in the MARK2PVA log.
GIMBAL	7	Translation from the IMU center of navigation to the gimbal mount center of rotation.
MARK3	9	Translation from the IMU center of navigation to the MARK3 output location. This offset shifts the position and velocity information in the MARK3PVA log.
MARK4	10	Translation from the IMU center of navigation to the MARK4 output location. This offset shifts the position and velocity information in the MARK4PVA log.

Table 197: Translation Input Frame

ASCII Value	Binary Value	Description
IMUBODY	0	Offset is provided in the IMU enclosure frame. Default: IMUBODY
VEHICLE	1	Offset is provided in the vehicle frame. Offsets entered in the vehicle frame will be automatically rotated into the IMU frame using the best available RBV (rotation from IMU Body to Vehicle) information when required. Vehicle frame offsets should only be used if the RBV is known accurately, either through user measurement or calibration. The order of entry for vehicle frame offsets and the RBV rotation does not matter.

4.16 SETINSUPDATE

Enable/Disable INS Filter Updates

Platform: OEM719, OEM729, OEM7500, OEM7600, OEM7700, OEM7720, PwrPak7, SPAN CPT7, SMART7-S, SMART7-SI



This command should only be used by advanced users of GNSS+INS.

Use this command to enable or disable the available INS filter updates.

Message ID: 1821

Abbreviated ASCII Syntax:

```
SETINSUPDATE INSUpdate Trigger
```

Abbreviated ASCII Example:

```
SETINSUPDATE ZUPT DISABLE
```

Field	Field Type	ASCII Value	Binary Value	Description	Binary Format	Binary Bytes	Binary Offset
1	SETINSUPDATE header	-	-	Command header. See <i>Messages</i> on page 27 for more information.	-	H	0
2	INSUpdate	POS	0	Position updates	Enum	4	H
		ZUPT	1	Zero velocity updates			
		PSR	2	Pseudorange updates			
		ADR	3	Carrier phase updates			
		DOPPLER	4	Doppler updates			
		ALIGN	5	Heading updates			
3	Trigger	DISABLE	0	Disable the INS update specified in the INSUpdate field.	Enum	4	H+4
		ENABLE	1	Enable the INS update specified in the INSUpdate field.			

4.17 SETRELINSOUTPUTFRAME

Sets the Relative INS Output Frame

Platform: OEM719, OEM729, OEM7500, OEM7600, OEM7700, OEM7720, PwrPak7, SPAN CPT7, SMART7-S, SMART7-SI

Use this command to change the frame of the output solution provided in the RELINSPVA and SYNCRELINSPVA logs. See **RELINSPVA** log on page 941 and **SYNCRELINSPVA** log on page 944 for information about these logs.

See in the [OEM7 SPAN Installation and Operation User Manual](#) for information about the Relative INS functionality.

Message ID: 1775

Abbreviated ASCII Syntax:

```
SETRELINSOUTPUTFRAME OutputFrame [DiffCriteria]
```

Abbreviated ASCII Example:

```
SETRELINSOUTPUTFRAME ECEF TRUE
```

Field	Field Type	ASCII Value	Binary Value	Description	Binary Format	Binary Bytes	Binary Offset
1	SETRELINS OUTPUTFRAME header	-	-	Command header. See <i>Messages</i> on page 27 for more information.	-	H	0
2	OutputFrame	ROVER	1	Frame of the output solution in the RELINSPVA and SYNCRELINSPVA logs.	Enum	4	H
		MASTER	2	ROVER – the output frame of the rover INS solution MASTER – the output frame of the master INS solution			
		ECEF	3	ECEF – Earth Centered Earth Fixed			
		LOCALLEVEL	4	LOCALLEVEL – Local level The default is the ROVER.			

Field	Field Type	ASCII Value	Binary Value	Description	Binary Format	Binary Bytes	Binary Offset
3	DiffCriteria	FALSE	0	The delta solution is computed as Rover minus Master. (default)	Bool	1	H+4
		TRUE	1	The delta solution is computed as Master minus Rover.			

Chapter 5 SPAN Logs

The SPAN specific logs follow the same general logging scheme as normal OEM7 Family logs. They are available in ASCII or binary formats and are defined as being either synchronous or asynchronous. All the logs in this chapter are used only with the SPAN system.

For information on other available logs and output logging, refer to *Logs* on page 346.

One difference from the standard OEM7 Family logs is there are two possible headers for the ASCII and binary versions of the logs. Which header is used for a given log is described in the log definitions in this chapter. The reason for the alternate short headers is that the normal OEM7 binary header is quite long at 28 bytes. This is nearly as long as the data portion of many of the INS logs and creates excess storage and baud rate requirements. Note that the INS related logs contain a time tag within the data block in addition to the time tag in the header. The time tag in the data block should be considered the exact time of applicability of the data. All INS Position, Velocity and Attitude logs can be obtained at a rate of up to 200 Hz. The standard deviation and update logs are available once per second.



Each ASCII log ends with a hexadecimal number preceded by an asterisk and followed by a line termination using the carriage return and line feed characters, for example, ***1234ABCD[CR][LF]**. This value is a 32-bit CRC of all bytes in the log, excluding the '#' or '%' identifier and the asterisk preceding the four checksum digits. See also *Description of ASCII and Binary Logs with Short Headers* on page 42.

Table 198: Inertial Solution Status on page 863 shows the status values included in the INS position, velocity and attitude output logs. If the IMU is connected properly and a good status value is not being received, check the hardware setup to ensure it is properly connected. This situation can be recognized in the RAWIMU data by observing accelerometer and gyro values which are not changing with time.



Logging Restriction Important Notice

Logging excessive amounts of high rate data can overload the system. When configuring the output for SPAN, NovAtel recommends that only one high rate (>50Hz) message be configured for output at a time. It is possible to log more than one message at high rates, but doing so could have negative impacts on the system. Also, if logging 100/125/200Hz data, always use the binary format.

For optimal performance, log only one high rate output at a time. These logs could be:

- Raw data for post processing
RAWIMUXSB ONNEW (100, 125 or 200 Hz depending on IMU)
 - RAWIMU logs are not valid with the ONTIME trigger. The raw IMU observations contained in these logs are sequential changes in velocity and rotation. As such, you can only use them for navigation if they are logged at their full rate.
- Real time INS solution
INSPVASB ONTIME 0.01 or 0.005 (maximum rate equals the IMU rate)
 - Other possible INS solution logs available at high rates are: INSPOSSB, INSVLSB, INSATTSB



The periods available when using the ONTIME trigger are 0.005 (200 Hz), 0.01 (100 Hz), 0.02 (50 Hz), 0.05, 0.1, 0.2, 0.25, 0.5, 1, and any integer number of seconds.

5.1 Logs with INS or GNSS Data

There are several logs in the system designed to output the best available solution as well as many logs that output only a specific solution type (PSR, RTK, INS, etc). The table below lists the logs that can provide either a GNSS solution or an INS solution. Most of these derive from the solution the system picks as the best solution. SPAN systems also have a secondary best solution that derives from the GNSS solution only (**BESTGNSSPOS** log (see page 846) and **BESTGNSSVEL** log (see page 849)). The position output from these logs is at the phase center of the antenna.

Log	Log Format	GNSS/INS
BESTPOS	NovAtel	YES
BESTVEL	NovAtel	YES
BESTUTM	NovAtel	YES
BESTXYZ	NovAtel	YES
GPGGA	NMEA	YES
GPGLL	NMEA	YES
GPVTG	NMEA	YES

5.2 BESTGNSSPOS

Best GNSS Position

Platform: OEM719, OEM729, OEM7500, OEM7600, OEM7700, OEM7720, PwrPak7, SPAN CPT7, SMART7-S, SMART7-SI

This log contains the best available GNSS position (without INS) computed by the receiver. In addition, it reports several status indicators, including differential age, which is useful in predicting anomalous behavior brought about by outages in differential corrections. A differential age of 0 indicates that no differential correction was used.

With the system operating in an RTK mode, this log reflects the latest low latency solution for up to 60 seconds after reception of the last base station observations. After this 60 second period, the position reverts to the best solution available and the degradation in accuracy is reflected in the standard deviation fields. If the system is not operating in an RTK mode, pseudorange differential solutions continue for the time specified in the **PSRDIFFTIMEOUT** command (see page 227).



BESTGNSSPOS always outputs positions at the antenna phase center.

Message ID: 1429

Log Type: Synch

Recommended Input:

```
log bestgnssposa ontime 1
```

ASCII Example:

```
#BESTGNSSPOSA,COM1,0,92.5,FINESTEERING,1692,332119.000,02000000,8505,43521;  
SOL_COMPUTED,SINGLE,51.11635530655,-114.03819448382,1064.6283,-16.9000,WGS84,  
1.2612,0.9535,2.7421,"",0.000,0.000,11,11,11,11,0,06,00,03*52d3f7c0
```

Field	Field type	Data Description	Format	Binary Bytes	Binary Offset
1	BESTGNSSPOS Header	Log header. See <i>Messages</i> on page 27 for more information.	-	H	0
2	Sol Status	Solution status, see <i>Table 65: Solution Status</i> on page 374	Enum	4	H
3	Pos Type	Position type, see <i>Table 66: Position or Velocity Type</i> on page 375	Enum	4	H+4
4	Lat	Latitude (degrees)	Double	8	H+8
5	Lon	Longitude (degrees)	Double	8	H+16
6	Hgt	Height above mean sea level (meters)	Double	8	H+24

Field	Field type	Data Description	Format	Binary Bytes	Binary Offset
7	Undulation	Undulation - the relationship between the geoid and the ellipsoid (m) of the chosen datum <div style="border: 1px solid black; padding: 5px; width: fit-content;">  <p>When using a datum other than WGS84, the undulation value also includes the vertical shift due to differences between the datum in use and WGS84.</p> </div>	Float	4	H+32
8	Datum ID	Datum ID 61 = WGS84 63 = USER	Enum	4	H+36
9	Lat σ	Latitude standard deviation (meters)	Float	4	H+40
10	Lon σ	Longitude standard deviation (meters)	Float	4	H+44
11	Hgt σ	Height standard deviation (meters)	Float	4	H+48
12	Stn ID	Base station ID	Char[4]	4	H+52
13	Diff_age	Differential age in seconds	Float	4	H+56
14	Sol_age	Solution age in seconds	Float	4	H+60
15	#SVs	Number of satellites tracked	Uchar	1	H+64
16	#solnSVs	Number of satellite solutions used in solution	Uchar	1	H+65
17	#solnL1SVs	Number of satellites with L1/E1/B1 signals used in solution	Uchar	1	H+66
18	#solnMultiSVs	Number of satellites with multi-frequency signals used in solution	Uchar	1	H+67
19	Reserved		Uchar	1	H+68
20	ext sol stat	Extended solution status (see <i>Table 69: Extended Solution Status</i> on page 378)	Hex	1	H+69
21	Galileo and BeiDou sig mask	Galileo and BeiDou signals used mask (see <i>Table 68: Galileo and BeiDou Signal-Used Mask</i> on page 378)	Hex	1	H+70
22	GPS and GLONASS sig mask	GPS and GLONASS signals used mask (see <i>Table 67: GPS and GLONASS Signal-Used Mask</i> on page 377)	Hex	1	H+71

Field	Field type	Data Description	Format	Binary Bytes	Binary Offset
23	xxxx	32-bit CRC (ASCII and Binary only)	Hex	4	H+72
24	[CR][LF]	Sentence terminator (ASCII only)	-	-	-

5.3 BESTGNSSVEL

Best Available GNSS Velocity Data

Platform: OEM719, OEM729, OEM7500, OEM7600, OEM7700, OEM7720, PwrPak7, SPAN CPT7, SMART7-S, SMART7-SI

This log contains the best available GNSS velocity information (without INS) computed by the receiver. In addition, it reports a velocity status indicator, which is useful to indicate whether or not the corresponding data is valid. The velocity measurements sometimes have a latency associated with them. The time of validity is the time tag in the log minus the latency value.

The velocity is typically computed from the average change in pseudorange over the time interval or the RTK Low Latency filter. As such, it is an average velocity based on the time difference between successive position computations and not an instantaneous velocity at the BESTGNSSVEL time tag. The velocity latency to be subtracted from the time tag is normally half the time between filter updates. Under default operation, the positioning filters are updated at a rate of 2 Hz. This translates into a velocity latency of 0.25 seconds. The latency is reduced by increasing the update rate of the positioning filter used by requesting the BESTGNSSVEL or BESTGNSSPOS messages at a rate higher than 2 Hz. For example, a logging rate of 10 Hz reduces the velocity latency to 0.005 seconds. For integration purposes, the velocity latency should be applied to the record time tag.

A valid solution with a latency of 0.0 indicates the instantaneous Doppler measurement was used to calculate velocity.

Message ID: 1430

Log Type: Synch

Recommended Input:

```
log bestgnssvela ontime 1
```

ASCII Example:

```
#BESTGNSSVELA,COM1,0,91.5,FINESTEERING,1692,332217.000,02000000,00b0,43521;SOL_
COMPUTED,DOPPLER_VELOCITY,0.150,0.000,0.0168,323.193320,0.0232,0.0*159c13ad
```

Field	Field type	Data Description	Format	Binary Bytes	Binary Offset
1	BESTGNSSVEL Header	Log header. See <i>Messages</i> on page 27 for more information.	-	H	0
2	Sol Status	Solution status, see <i>Table 65: Solution Status</i> on page 374	Enum	4	H
3	Vel Type	Velocity type, see <i>Table 66: Position or Velocity Type</i> on page 375	Enum	4	H+4
4	Latency	A measure of the latency in the velocity time tag in seconds. It should be subtracted from the time to give improved results.	Float	4	H+8
5	Age	Differential age	Float	4	H+12

Field	Field type	Data Description	Format	Binary Bytes	Binary Offset
6	Hor Spd	Horizontal speed over ground, in meters per second	Double	8	H+16
7	Trk Gnd	Actual direction of motion over ground (track over ground) with respect to True North, in degrees	Double	8	H+24
8	Vert Spd	Vertical speed, in meters per second, where positive values indicate increasing altitude (up) and negative values indicate decreasing altitude (down)	Double	8	H+32
9	Reserved		Float	4	H+40
10	xxxx	32-bit CRC (ASCII and Binary only)	Hex	4	H+44
11	[CR][LF]	Sentence terminator (ASCII only)	-	-	-

5.4 CORRIMUDATA

Corrected IMU Measurements

Platform: OEM719, OEM7500, OEM7700, SMART7-S, SMART7-SI

The CORRIMUDATA log contains the RAWIMU data corrected for gravity, the earth's rotation and estimated sensor errors. The values in this log are incremental values, accumulated over the logging interval of CORRIMUDATA, in units of radians for the attitude rate and m/s for the accelerations. Data output is not in the IMU Body frame, but is automatically rotated into the user configured output frame (configured with the **SETINSROTATION** command (see page 835), default Vehicle frame).



The short header format, CORRIMUDATAS, is recommended, as it is for all high data rate logs.

CORRIMUDATA can be logged with the ONTIME trigger, up to a rate of 200 Hz.



Since the CORRIMUDATA log is synchronous, if you log at a rate less than full data rate of the IMU, the corrected IMU data is accumulated to match the requested time interval. For asynchronous, full rate data, see the **IMURATECORRIMUS** log on page 856.



To obtain the instantaneous rates of acceleration (in m/s/s) or rotation (in rad/s) from the output values of measurements per sample rate (m/s/sample and rad/sample), multiply the output values by the CORRIMUDATA logging rate in Hz.

Message ID: 812

Log Type: Synch

Recommended Input:

```
log corrimudatab ontime 0.01
```

Example log:

```
#CORRIMUDATAA, COM1, 0, 77.5, FINESTEERING, 1769, 237601.000, 02000020, bdba, 12597;  
1769, 237601.000000000, -0.000003356, 0.000002872, 0.000001398, 0.000151593,  
0.000038348, -0.000078820*1f7eb709
```

Field	Field Type	Description	Format	Binary Bytes	Binary Offset
1	CORRIMUDATA Header	Log header. See <i>Messages</i> on page 27 for more information.	-	H	0
2	Week	GNSS week	Ulong	4	H+
3	Seconds	GNSS seconds from week start	Double	8	H+4

Field	Field Type	Description	Format	Binary Bytes	Binary Offset
4	PitchRate	About x axis rotation (right-handed) (rad/sample)	Double	8	H+12
5	RollRate	About y axis rotation (right-handed) (rad/sample)	Double	8	H+20
6	YawRate	About z axis rotation (right-handed) (rad/sample)	Double	8	H+28
7	LateralAcc	INS Lateral Acceleration (along x axis) (m/s/sample)	Double	8	H+36
8	LongitudinalAcc	INS Longitudinal Acceleration (along y axis) (m/s/sample)	Double	8	H+44
9	VerticalAcc	INS Vertical Acceleration (along z axis) (m/s/sample)	Double	8	H+52
10	xxxx	32-bit CRC	Hex	4	H+56
11	[CR][LF]	Sentence Terminator (ASCII only)	-	-	-

5.5 CORRIMUDATAS

Short Corrected IMU Measurements

Platform: OEM719, OEM7500, OEM7700, SMART7-S, SMART7-SI

This log is the short header version of the **CORRIMUDATA** log (see page 851).



To obtain the instantaneous rates of acceleration (in m/s/s) or rotation (in rad/s) from the output values of measurements per sample rate (m/s/sample and rad/sample), multiply the output values by the CORRIMUDATAS logging rate in Hz.

Message ID: 813

Log Type: Synch

Recommended Input:

```
log corrimudatasb ontime 0.01
```

Example log:

```
%CORRIMUDATASA,1581,341553.000;1581,341552.997500000,-0.000000690,-0.000001549,0.000001654,0.000061579,-0.000012645,-0.000029988*770c6232
```

Field	Field Type	Description	Format	Binary Bytes	Binary Offset
1	CORRIMUDATAS Header	Log header. See <i>Messages</i> on page 27 for more information.	-	H	0
2	Week	GNSS week	Ulong	4	H+
3	Seconds	GNSS seconds from week start	Double	8	H+4
4	PitchRate	About x-axis rotation (right-handed) (rad/sample)	Double	8	H+12
5	RollRate	About y-axis rotation (right-handed) (rad/sample)	Double	8	H+20
6	YawRate	About z-axis rotation (right-handed) (rad/sample)	Double	8	H+28
7	LateralAcc	INS Lateral Acceleration (along x-axis) (m/s/sample)	Double	8	H+36
8	LongitudinalAcc	INS Longitudinal Acceleration (along y-axis) (m/s/sample)	Double	8	H+44
9	VerticalAcc	INS Vertical Acceleration (along z-axis) (m/s/sample)	Double	8	H+52
10	xxxx	32-bit CRC	Hex	4	H+56
11	[CR][LF]	Sentence Terminator (ASCII only)	-	-	-

5.6 GIMBALLEDPVA

Display Gimballed Position

Platform: OEM719, OEM729, OEM7500, OEM7600, OEM7700, OEM7720, PwrPak7, SPAN CPT7, SMART7-S, SMART7-SI

Use the GIMBALLEDPVA log to view the re-calculated position, velocity and attitude of the gimballed null position.



This log should only be requested with the ONCHANGED or ONTIME trigger.

Message ID: 1321

Log Type: Asynch

Recommended Input:

```
log gimballedpvaa onnew
```

ASCII Example:

```
#GIMBALLEDPVAA,COM1,0,93.5,FINESTEERING,1635,320568.514,02000000,0000,407;1635,
320568.514000000,51.116376614,-114.038259915,1046.112025828,-0.000291756,
-0.000578067,0.030324466,-0.243093917,-0.127718304,19.495023227,
INS_ALIGNMENT_COMPLETE*32fbb61b
```

Field	Field Type	Description	Format	Binary Bytes	Binary Offset
1	GIMBALLEDPVA Header	Log header. See <i>Messages</i> on page 27 for more information.	-	H	0
2	Week	GPS week	Ulong	4	H
3	Seconds	Seconds from week start	Double	8	H+4
4	Latitude	WGS84 latitude in degrees	Double	8	H+12
5	Longitude	WGS84 longitude in degrees	Double	8	H+20
6	Height	WGS84 ellipsoidal height	Double	8	H+28
7	North Velocity	Velocity in a northerly direction	Double	8	H+36
8	East Velocity	Velocity in an easterly direction	Double	8	H+44
9	Up Velocity	Velocity in an upward direction	Double	8	H+52
10	Roll	Right-handed rotation from local level around the y-axis in degrees	Double	8	H+60
11	Pitch	Right-handed rotation from local level around the x-axis in degrees	Double	8	H+68

Field	Field Type	Description	Format	Binary Bytes	Binary Offset
12	Azimuth	Right-handed rotation from local level around the z-axis in degrees	Double	8	H+76
13	Status	INS status, see <i>Table 198: Inertial Solution Status</i> on page 863	Enum	4	H+84
14	xxxx	32-bit CRC	Hex	4	H+88
15	[CR][LF]	Sentence Terminator (ASCII only)	-	-	-

5.7 IMURATECORRIMUS

Asynchronous Corrected IMU Data

Platform: OEM719, OEM729, OEM7500, OEM7600, OEM7700, OEM7720, PwrPak7, SPAN CPT7, SMART7-S, SMART7-SI

This log provides the same information as the **CORRIMUDATAS** log (see page 853), but is available asynchronously at the full rate of the IMU.



Using this log consumes significant system resources and should only be used by experienced users.

However, using this log consumes less resources than logging the synchronous CORRIMUDATAS log at the same rate.



To obtain the instantaneous rates of acceleration (in m/s/s) or rotation (in rad/s) from the output values of measurements per sample rate (m/s/sample and rad/sample), multiply the output values by the IMU data rate in Hz.



This log should only be requested with the ONCHANGED or ONTIME trigger.

Message ID: 1362

Log Type: Asynch

Recommended Input:

```
log imuratecorrimusb onnew
```

Example log:

```
%IMURATECORRIMUSA,1581,341553.000;1581,341552.997500000,-0.000000690,-0.000001549,0.000001654,0.000061579,-0.000012645,-0.000029988*770c6232
```

Field	Field Type	Description	Format	Binary Bytes	Binary Offset
1	IMURATECORRIMUS Header	Log header. See <i>Messages</i> on page 27 for more information.	-	H	0
2	Week	GNSS week	Ulong	4	H+
3	Seconds	GNSS seconds from week start	Double	8	H+4
4	PitchRate	About x axis rotation (rad/sample)	Double	8	H+12
5	RollRate	About y axis rotation (rad/sample)	Double	8	H+20
6	YawRate	About z axis rotation (right-handed) (rad/sample)	Double	8	H+28

Field	Field Type	Description	Format	Binary Bytes	Binary Offset
7	LateralAcc	INS Lateral Acceleration (along x-axis) (m/s/sample)	Double	8	H+36
8	LongitudinalAcc	INS Longitudinal Acceleration (along y-axis) (m/s/sample)	Double	8	H+44
9	VerticalAcc	INS Vertical Acceleration (along z-axis)(m/s/sample)	Double	8	H+52
10	xxxx	32-bit CRC	Hex	4	H+56
11	[CR][LF]	Sentence Terminator (ASCII only)	-	-	-

5.8 IMURATEPVA

Asynchronous INS Position, Velocity and Attitude

Platform: OEM719, OEM729, OEM7500, OEM7600, OEM7700, OEM7720, PwrPak7, SPAN CPT7, SMART7-S, SMART7-SI

This log provides the same information as the **INSPVA** log (see page 881), but is available asynchronously at the full rate of the IMU.



Using this log consumes significant system resources and should only be used by experienced users.

However, using this log consumes less resources than logging the synchronous INSPVA log at the same rate.



This log should only be requested with the ONCHANGED or ONTIME trigger.

Message ID: 1778

Log Type: Asynch

Recommended Input:

```
log imuratepvaa onnew
```

ASCII Example:

```
#IMURATEPVAA,COM1,0,57.0,FINESTEERING,1802,320345.180,02000000,9b1f,12987;1802,320345.180000030,51.11695246671,-114.03897779953,1047.6905,-0.2284,0.0076,0.2227,0.160588332,-0.039823409,269.988184416,INS_ALIGNMENT_COMPLETE*f60016a6
```

Field	Field Type	Description	Format	Binary Bytes	Binary Offset
1	IMURATEPVA Header	Log header. See <i>Messages</i> on page 27 for more information.	-	H	0
2	Week	GNSS Week	Ulong	4	H
3	Seconds	Seconds from week start	Double	8	H+4
4	Latitude	Latitude (WGS84) [degrees]	Double	8	H+12
5	Longitude	Longitude (WGS84) [degrees]	Double	8	H+20
6	Height	Ellipsoidal Height (WGS84) [m]	Double	8	H+28
7	North Velocity	Velocity in a northerly direction (a -ve value implies a southerly direction) [m/s]	Double	8	H+36
8	East Velocity	Velocity in an easterly direction (a -ve value implies a westerly direction) [m/s]	Double	8	H+44

Field	Field Type	Description	Format	Binary Bytes	Binary Offset
9	Up Velocity	Velocity in an up direction [m/s]	Double	8	H+52
10	Roll	Right-handed rotation from local level around y-axis in degrees	Double	8	H+60
11	Pitch	Right-handed rotation from local level around x-axis in degrees	Double	8	H+68
12	Azimuth	Left-handed rotation around z-axis in degrees clockwise from North This is the inertial azimuth calculated from the IMU gyros and the SPAN filters.	Double	8	H+76
13	Status	INS Status, see <i>Table 198: Inertial Solution Status</i> on page 863	Enum	4	H+84
14	xxxx	32-bit CRC	Hex	4	H+88
15	[CR][LF]	Sentence Terminator (ASCII only)	-	-	-

5.9 IMURATEPVAS

Asynchronous INS Position, Velocity and Attitude

Platform: OEM719, OEM729, OEM7500, OEM7600, OEM7700, OEM7720, PwrPak7, SPAN CPT7, SMART7-S, SMART7-SI

This log provides the same information as the **INSPVAS** log (see page 885), but is available asynchronously at the full rate of the IMU.



Using this log consumes significant system resources and should only be used by experienced users.

However, using this log consumes less resources than logging the synchronous INSPVAS log at the same rate.



This log should only be requested with the ONCHANGED or ONTIME trigger.

Message ID: 1305

Log Type: Asynch

Recommended Input:

```
log imuratepvas
```

ASCII Example:

```
%IMURATEPVASA,1264,144059.000;1264,144059.002135700,51.116680071,
-114.037929194,515.286704183,277.896368884,84.915188605,-8.488207941,
0.759619515,-2.892414901,6.179554750,INS_ALIGNMENT_COMPLETE*855d6f76
```

Field	Field Type	Description	Format	Binary Bytes	Binary Offset
1	IMURATEPVAS Header	Log header. See <i>Messages</i> on page 27 for more information.	-	H	0
2	Week	GNSS Week	Ulong	4	H
3	Seconds	Seconds from week start	Double	8	H+4
4	Latitude	Latitude (WGS84)	Double	8	H+12
5	Longitude	Longitude (WGS84)	Double	8	H+20
6	Height	Ellipsoidal Height (WGS84) [m]	Double	8	H+28
7	North Velocity	Velocity in a northerly direction (a -ve value implies a southerly direction) [m/s]	Double	8	H+36
8	East Velocity	Velocity in an easterly direction (a -ve value implies a westerly direction) [m/s]	Double	8	H+44

Field	Field Type	Description	Format	Binary Bytes	Binary Offset
9	Up Velocity	Velocity in an up direction [m/s]	Double	8	H+52
10	Roll	Right-handed rotation from local level around y-axis in degrees	Double	8	H+60
11	Pitch	Right-handed rotation from local level around x-axis in degrees	Double	8	H+68
12	Azimuth	Left-handed rotation around z-axis in degrees clockwise from North	Double	8	H+76
13	Status	INS Status, see <i>Table 198: Inertial Solution Status</i> on page 863	Enum	4	H+84
14	xxxx	32-bit CRC	Hex	4	H+88
15	[CR][LF]	Sentence Terminator (ASCII only)	-	-	-

5.10 INSATT

INS Attitude

Platform: OEM719, OEM729, OEM7500, OEM7600, OEM7700, OEM7720, PwrPak7, SPAN CPT7, SMART7-S, SMART7-SI

This log contains the most recent attitude measurements computed by the SPAN filter. This attitude definition may not correspond to other definitions of the terms pitch, roll and azimuth. By default, the output attitude is with respect to the vehicle frame. If the attitude output is desired with respect to another frame of reference, use the **SETINSROTATION USER** command (see the **SETINSROTATION** command on page 835) to configure the user output frame offset rotation.

Message ID: 263

Log Type: Synch

Recommended Input:

```
log insatta ontime 1
```

ASCII Example:

```
#INSATTA,USB2,0,14.5,FINESTEERING,1541,487970.000,02040000,5b35,37343;1541,487970.000549050,1.876133508,-4.053672765,328.401460897,INS_SOLUTION_GOOD*ce4ac533
```

Field	Field Type	Description	Format	Binary Bytes	Binary Offset
1	INSATT Header	Log header. See <i>Messages</i> on page 27 for more information.	-	H	0
2	Week	GNSS Week	Ulong	4	H
3	Seconds into Week	Seconds from week start	Double	8	H+4
4	Roll	Right-handed rotation from local level around y-axis in degrees.	Double	8	H+12
5	Pitch	Right-handed rotation from local level around x-axis in degrees.	Double	8	H+20
6	Azimuth	Left-handed rotation around z-axis in degrees clockwise from North. This is the inertial azimuth calculated from the IMU gyros and the SPAN filters.	Double	8	H+28
7	Status	INS status, see <i>Table 198: Inertial Solution Status</i> on the next page.	Enum		H+36
8	xxxx	32-bit CRC (ASCII, Binary and Short Binary only)	Hex		H+40
9	[CR][LF]	Sentence terminator (ASCII only)	-	-	-

Table 198: Inertial Solution Status

Binary	ASCII	Description
0	INS_INACTIVE	IMU logs are present, but the alignment routine has not started; INS is inactive.
1	INS_ALIGNING	INS is in alignment mode.
2	INS_HIGH_VARIANCE	<p>The INS solution is in navigation mode but the azimuth solution uncertainty has exceeded the threshold. The default threshold is 2 degrees for most IMUs. The solution is still valid but you should monitor the solution uncertainty in the INSSTDEV log (see page 898). You may encounter this state during times when the GNSS, used to aid the INS, is absent.</p> <p>The INS solution uncertainty contains outliers and the solution may be outside specifications.¹ The solution is still valid but you should monitor the solution uncertainty in the INSSTDEV log (see page 898). It may be encountered during times when GNSS is absent or poor.</p>
3	INS_SOLUTION_GOOD	The INS filter is in navigation mode and the INS solution is good.
6	INS_SOLUTION_FREE	<p>The INS filter is in navigation mode and the GNSS solution is suspected to be in error.</p> <p>This may be due to multipath or limited satellite visibility. The inertial filter has rejected the GNSS position and is waiting for the solution quality to improve.</p>
7	INS_ALIGNMENT_COMPLETE	The INS filter is in navigation mode, but not enough vehicle dynamics have been experienced for the system to be within specifications.
8	DETERMINING_ORIENTATION	INS is determining the IMU axis aligned with gravity.
9	WAITING_INITIALPOS	The INS filter has determined the IMU orientation and is awaiting an initial position estimate to begin the alignment process.
10	WAITING_AZIMUTH	The INS filter has orientation, initial biases, initial position and valid roll/pitch estimated. Will not proceed until initial azimuth is entered.
11	INITIALIZING_BIASES	The INS filter is estimating initial biases during the first 10 seconds of stationary data.
12	MOTION_DETECT	The INS filter has not completely aligned, but has detected motion.

¹The solution uncertainty threshold levels can be adjusted using the **INSTHRESHOLDS** command on page 827.

5.11 INSATTQS

Short INS Quaternion Attitude

Platform: OEM719, OEM729, OEM7500, OEM7600, OEM7700, OEM7720, PwrPak7, SPAN CPT7, SMART7-S, SMART7-SI

This log contains the attitude from the INSATT log, but the rotation from local level is given as a Quaternion rather than Euler Angles. The quaternion takes the form:

$$\mathbf{q}_i^b = [w \ x \ y \ z]^T$$

The element w is the rotational component, defining the magnitude of the rotation to be performed. The elements x , y , and z are the vector portion of the rotation, which define the axis about which the rotation is to be performed.

If θ is the rotational angle, and the axis of rotation is defined by the vector $\mathbf{v} = [v_x \ v_y \ v_z]^T$, then the elements of the quaternion can be written as:

$$w = \cos \frac{\theta}{2}$$

$$x = v_x \sin \frac{\theta}{2}$$

$$y = v_y \sin \frac{\theta}{2}$$

$$z = v_z \sin \frac{\theta}{2}$$

Message ID: 2118

Log Type: Synch

Recommended Input:

```
log insattqsa ontime 1
```

ASCII Example:

```
%INSATTQSA,1943,425090.000;1943,425090.000000000,0.706276782,0.001974400,-0.001083571,-0.707932225,INS_ALIGNMENT_COMPLETE*552d93f0
```

Field	Field Type	Description	Format	Binary Bytes	Binary Offset
1	INSATTQS Header	Log header. See <i>Messages</i> on page 27 for more information.	-	H	0
2	Week	GNSS Week	Ulong	4	H
3	Seconds into Week	Seconds from week start	Double	8	H+4
4	Quaternion w	Quaternion rotation from local level, w component	Double	8	H+12

Field	Field Type	Description	Format	Binary Bytes	Binary Offset
5	Quaternion x	Quaternion rotation from local level, x component	Double	8	H+20
6	Quaternion y	Quaternion rotation from local level, y component	Double	8	H+28
7	Quaternion z	Quaternion rotation from local level, z component	Double	8	H+36
8	Status	INS status, see <i>Table 198: Inertial Solution Status</i> on page 863	Enum	4	H+44
9	xxxx	32-bit CRC (ASCII, Binary and Short Binary only)	Hex	4	H+48
10	[CR][LF]	Sentence Terminator (ASCII only)	-	-	-

5.12 INSATTS

Short INS Attitude

Platform: OEM719, OEM729, OEM7500, OEM7600, OEM7700, OEM7720, PwrPak7, SPAN CPT7, SMART7-S, SMART7-SI

This log is the short header version of the **INSATT** log (see page 862).

Message ID: 319

Log Type: Synch

Recommended Input:

```
log insattsa ontime 1
```

ASCII Example:

```
%INSATTSA,1541,487975.000;1541,487975.000549050,2.755452422,-4.127365126,323.289778434,INS_SOLUTION_GOOD*ba08754f
```

Field	Field Type	Description	Format	Binary Bytes	Binary Offset
1	INSATTS Header	Log header. See <i>Messages</i> on page 27 for more information.	-	H	0
2	Week	GNSS Week	Ulong	4	H
3	Seconds into Week	Seconds from week start	Double	8	H+4
4	Roll	Right-handed rotation from local level around y-axis in degrees	Double	8	H+12
5	Pitch	Right-handed rotation from local level around x-axis in degrees	Double	8	H+20
6	Azimuth	Left-handed rotation around z-axis in degrees clockwise from North This is the inertial azimuth calculated from the IMU gyros and the SPAN filters.	Double	8	H+28
7	Status	INS status, see <i>Table 198: Inertial Solution Status</i> on page 863	Enum	4	H+36
8	xxxx	32-bit CRC (ASCII, Binary and Short Binary only)	Hex	4	H+40
9	[CR][LF]	Sentence terminator (ASCII only)	-	-	-

5.13 INSATTX

Inertial Attitude – Extended

Platform: OEM719, OEM729, OEM7500, OEM7600, OEM7700, OEM7720, PwrPak7, SPAN CPT7, SMART7-S, SMART7-SI

This log includes the information from the **INSATT** log (see page 862), as well as information about the attitude standard deviation. The position type and solution status fields indicate whether or not the corresponding data is valid.



The INSATTX log is a large log and is not recommend for high rate logging.

If you want to use high rate logging, log the **INSATTS** log at a high rate and the **INSSTDEVS** log ontime 1.

Message ID: 1457

Log Type: Synch

Recommended Input:

```
log insattxa ontime 1
```

ASCII Example:

```
#INSATTXA,COM1,0,81.0,FINESTEERING,1690,494542.000,02000040,5d25,43441;  
INS_ALIGNMENT_COMPLETE,INS_PSRSP,1.137798832,-0.163068414,135.754208544,  
0.017797431,0.017861038,3.168394804,4,0*f944b004
```

Field	Field Type	Description	Format	Binary Bytes	Binary Offset
1	INSATTX Header	Log header. See <i>Messages</i> on page 27 for more information.		H	0
2	INS Status	Solution status See <i>Table 198: Inertial Solution Status</i> on page 863	Enum	4	H
3	Pos Type	Position type See <i>Table 66: Position or Velocity Type</i> on page 375	Enum	4	H+4
4	Roll	Roll in Local Level (degrees)	Double	8	H+8
5	Pitch	Pitch in Local Level (degrees)	Double	8	H+16
6	Azimuth	Azimuth in Local Level (degrees) This is the inertial azimuth calculated from the IMU gyros and the SPAN filters.	Double	8	H+24
7	Roll σ	Roll standard deviation (degrees)	Float	4	H+32
8	Pitch σ	Pitch standard deviation (degrees)	Float	4	H+36

Field	Field Type	Description	Format	Binary Bytes	Binary Offset
9	Azimuth σ	Azimuth standard deviation (degrees)	Float	4	H+40
10	Ext sol stat	Extended solution status See Table 199: <i>Extended Solution Status</i> below	Hex	4	H+44
11	Time Since Update	Elapsed time since the last ZUPT or position update (seconds)	Ushort	2	H+48
12	xxxx	32-bit CRC (ASCII and Binary only)	Hex	4	H+50
13	[CR][LF]	Sentence terminator (ASCII only)	-	-	-

Table 199: Extended Solution Status

Nibble	Bit	Mask	Description	Range Value
N0	0	0x00000001	Position update	0 = Unused 1 = Used
	1	0x00000002	Phase update	0 = Unused 1 = Used
	2	0x00000004	Zero velocity update	0 = Unused 1 = Used
	3	0x00000008	Wheel sensor update	0 = Unused 1 = Used
N1	4	0x00000010	ALIGN (heading) update	0 = Unused 1 = Used
	5	0x00000020	External position update	0 = Unused 1 = Used
	6	0x00000040	INS solution convergence flag	0 = Not converged 1 = Converged
	7	0x00000080	Doppler update	0 = Unused 1 = Used
N2	8	0x00000100	Pseudorange update	0 = Unused 1 = Used
	9	0x00000200	Velocity update	0 = Unused 1 = Used
	10	0x00000400	Reserved	
	11	0x00000800	Dead reckoning update	0 = Unused 1 = Used

Nibble	Bit	Mask	Description	Range Value
N3	12	0x00001000	Phase wind up update	0 = Unused 1 = Used
	13	0x00002000	Course over ground update	0 = Unused 1 = Used
	14	0x00004000	External velocity update	0 = Unused 1 = Used
	15	0x00008000	External attitude update	0 = Unused 1 = Used
N4	16	0x00010000	External heading update	0 = Unused 1 = Used
	17	0x00020000	External height update	0 = Unused 1 = Used
	18	0x00040000	Reserved	
	19	0x00080000	Reserved	
N5	20	0x00100000	Rover position update	0 = Unused 1 = Used
	21	0x00200000	Rover position update type	0 = Non-RTK update 1 = RTK integer update
	22	0x00400000	Reserved	
	23	0x00800000	Reserved	
N6	24	0x01000000	Turn on biases estimated	0 = Static turn-on biases not estimated (starting from zero) 1 = Static turn-on biases estimated
	25	0x02000000	Alignment direction verified	0 = Not verified 1 = Verified
	26	0x04000000	Alignment Indication 1	0 = Not set, 1 = Set Refer to <i>Table 200: Alignment Indication</i> on the next page
	27	0x08000000	Alignment Indication 2	0 = Not set, 1 = Set Refer to <i>Table 200: Alignment Indication</i> on the next page

Nibble	Bit	Mask	Description	Range Value
N7	28	0x10000000	Alignment Indication 3	0 = Not set, 1 = Set Refer to <i>Table 200: Alignment Indication</i> below
	29	0x20000000	NVM Seed Indication 1	0 = Not set, 1 = Set Refer to <i>Table 201: NVM Seed Indication</i> below
	30	0x40000000	NVM Seed Indication 2	0 = Not set, 1 = Set Refer to <i>Table 201: NVM Seed Indication</i> below
	31	0x80000000	NVM Seed Indication 3	0 = Not set, 1 = Set Refer to <i>Table 201: NVM Seed Indication</i> below

Table 200: Alignment Indication

Bits 26-28 Values	Hex Value	Completed Alignment Type
000	0x00	Incomplete Alignment
001	0x01	Static
010	0x02	Kinematic
011	0x03	Dual Antenna
100	0x04	User Command
101	0x05	NVM Seed

Table 201: NVM Seed Indication

Bit 29-31 Values	Hex Value	NVM Seed Type
000	0x00	NVM Seed Inactive
001	0x01	Seed stored in NVM is invalid
010	0x02	NVM Seed failed validation check
011	0x03	NVM Seed is pending validation (awaiting GNSS)
100	0x04	NVM Seed Injected (includes error model data)
101	0x05	NVM Seed data ignored due to a user-commanded filter reset or configuration change
110	0x06	NVM Seed error model data injected

5.14 INSCALSTATUS

Offset calibration status

Platform: OEM719, OEM729, OEM7500, OEM7600, OEM7700, OEM7720, PwrPak7, SPAN CPT7, SMART7-S, SMART7-SI

This log reports the status and estimated values of the currently running offset calibration.

Message ID: 1961

Log Type: Asynch

Abbreviated ASCII Syntax:

```
log inscalstatus onchanged
```

ASCII Example:

```
#INSCALSTATUSA,COM1,0,80.0,FINESTEERING,1880,317815.012,02000000,a4f2,32768;RBV,0.0000,-180.0000,-90.0000,45.0000,45.0000,45.0000,INS_CONVERGING,1*e0b3152d
```

Field	Field Type	Description	Binary Format	Binary Bytes	Binary Offset
1	INSCALSTATUS header	Log header. See <i>Messages</i> on page 27 for more information.	-	H	0
2	Offset Type	Type of offset (see <i>Table 202: Offset Type</i> on the next page).	Enum	4	H
3	X axis offset	IMU body frame X-axis offset (m/degrees).	Float	4	H+4
4	Y axis offset	IMU body frame Y-axis offset (m/degrees).	Float	4	H+8
5	Z axis offset	IMU body frame Z-axis offset (m/degrees).	Float	4	H+12
6	X uncertainty	IMU body frame X-axis offset uncertainty (m/degrees).	Float	4	H+16
7	Y uncertainty	IMU body frame Y-axis offset uncertainty (m/degrees).	Float	4	H+20
8	Z uncertainty	IMU body frame Z-axis offset uncertainty (m/degrees).	Float	4	H+24
9	Source Status	Source from which offset values originate (see <i>Table 203: Source Status</i> on the next page).	Enum	4	H+28
10	Multi-line Calibration Count	Counter for number of completed calibrations cumulatively averaged.	Ulong	4	H+32
11	xxxx	32-bit CRC (ASCII and Binary only).	Hex	4	H+36
12	[CR][LF]	Sentence terminator (ASCII only).	-	-	-



Units for the axis offset and uncertainty values (fields 3-8) are in meters for translational offset components and degrees for rotational offset components.

Table 202: Offset Type

Binary	ASCII	Description
1	ANT1	Primary IMU to antenna lever arm
8	ALIGN	Align offset
11	RBV	IMU body to vehicle offset

Table 203: Source Status

Binary	ASCII	Description
1	FROM_NVM	Offset values originate from saved parameters in NVM
2	CALIBRATING	Offset values originate from a currently running calibration process
3	CALIBRATED	Offset values originate from a completed calibration process
4	FROM_COMMAND	Offset values originate from a user command
5	RESET	Offset values originate from a system reset
6	FROM_DUAL_ANT	Offset values originate from a dual antenna Align solution
7	INS_CONVERGING	Offset values originate from initial input values. Calibration process on hold until INS solution is converged.
8	INSUFFICIENT_SPEED	Offset values originate from a currently running calibration process. Further estimation on hold due to insufficient speed.
9	HIGH_ROTATION	Offset values originate from a currently running calibration process. Further estimation on hold due to high vehicle rotations.

5.15 INSCONFIG

Determine required settings for post-processing or system analysis

Platform: OEM719, OEM729, OEM7500, OEM7600, OEM7700, OEM7720, PwrPak7, SPAN CPT7, SMART7-S, SMART7-SI

This log is the single message required to determine all required settings for post-processing or system analysis. This log is asynchronous and published for any change to the included fields. It is intended to be recorded occasionally though it could be updated frequently at system startup.

Message ID: 1945

Log Type: Polled

Recommended Input:

```
log insconfig onchanged
```

ASCII Example:

```
#INSCONFIGA,COM1,0,71.0,COARSESTEERING,1931,517331.006,02400000,6d7a,32768;
EPSON_G320,6,50,20,DEFAULT,00ffd1bf,AUTOMATIC,ROVER,FALSE,00000000,0,0,0,0,0,0,0,0,0,0,1,ANT1,IMUBODY,0.0540,0.0699,-0.0346,0.0200,0.0200,0.0200,FROM_NVM,1,RBV,
IMUBODY,180.0000,0.0000,90.0000,5.0000,5.0000,5.0000,FROM_COMMAND*b1233ac4
```

Field	Field Type	Description	Binary Format	Binary Bytes	Binary Offset
1	INSCONFIG Header	Command header. See <i>Messages</i> on page 27 for more information.	-	H	0
2	IMU Type	IMU type. See <i>Table 191: IMU Type</i> on page 813.	Enum	4	H
3	Mapping	Mapping / Orientation	Uchar	1	H+4
4	Initial Alignment Velocity	Minimum Alignment Velocity entered by the user (see the SETALIGNMENTVEL command on page 832). Note: Velocity (m/s) is scaled by 10 for 10cm/s precision	Uchar	1	H+5
5	Heave Window	Length of the heave window in seconds	Ushort	2	H+6
6	Profile	Profile setting (see the SETINSPROFILE command on page 834)	Enum	4	H+8
7	INS Enabled Updates	Enabled INS updates (see <i>Table 208: INS Update Values</i> on page 904)	Hex	4	H+12
8	Alignment Mode	Alignment mode configured on the system (see the ALIGNMENTMODE command on page 810)	Enum	4	H+16

Field	Field Type	Description	Binary Format	Binary Bytes	Binary Offset
9	Relative INS Output Frame	The user specified output frame of the Relative INS Vector (see SETRELINSOUTPUTFRAME command on page 842) If not specified, the default value appears.	Enum	4	H+20
10	Relative INS Output Direction	The User specified Output direction of the Relative INS Vector (From or To Master-Rover) (see the SETRELINSOUTPUTFRAME command on page 842). If not specified, the default value appears. TRUE if From Master, FALSE (Default) if From Rover	Bool	4	H+24
11	INS Receiver Status	Lower byte- INS Reset. Corresponds numerically to the INS Reset as described by the INSResetEnum Second byte- = 0x01 if an IMU Communication Error (Receiver status bit 17). = 0x00 otherwise. Other values are reserved for future use. Upper 2 bytes - reserved.	Hex	4	H+28
12	INS Seed Enabled	INS Seed Enable setting (see the INSSEED command on page 825) Enabled = 1, Disabled = 0	Uchar	1	H+32
13	INS Seed Validation	INS Seed Validation setting (see the INSSEED command on page 825)	Uchar	1	H+33
14	Reserved 1		N/A	2	H+34
15	Reserved 2		N/A	4	H+36
16	Reserved 3		N/A	4	H+40
17	Reserved 4		N/A	4	H+44
18	Reserved 5		N/A	4	H+48
19	Reserved 6		N/A	4	H+52
20	Reserved 7		N/A	4	H+56

Field	Field Type	Description	Binary Format	Binary Bytes	Binary Offset
21	Number of Translations	Number of translation entries to follow	Ulong	4	H+60
22	Translation	Translation to follow (see <i>Table 196: Translation Offset Types</i> on page 839)	Enum	4	variable
23	Frame	Frame of translation (IMUBODY or VEHICLE)	Enum	4	variable
24	X Offset	X Offset	Float	4	variable
25	Y Offset	Y Offset	Float	4	variable
26	Z Offset	Z Offset	Float	4	variable
27	X Uncertainty	X Uncertainty	Float	4	variable
28	Y Uncertainty	Y Uncertainty	Float	4	variable
29	Z Uncertainty	Z Uncertainty	Float	4	variable
30	Translation Source	Source of translation (see <i>Table 203: Source Status</i> on page 872)	Enum	4	variable
Next Translation					
variable	Number of Rotations	Number of rotation entries to follow	Ulong	4	variable
variable	Rotation	Rotation to follow (see <i>Table 195: Rotational Offset Types</i> on page 836)	Enum	4	variable
variable	Frame	Frame of rotation (IMUBODY or VEHICLE)	Enum	4	variable
variable	X Rotation	X Rotation	Float	4	variable
variable	Y Rotation	Y Rotation	Float	4	variable
variable	Z Rotation	Z Rotation	Float	4	variable
variable	X Rotation Std Dev	X Rotation offset standard deviation (degrees)	Float	4	variable
variable	Y Rotation STD Dev	Y Rotation offset standard deviation (degrees)	Float	4	variable
variable	Z Rotation STD Dev	Z Rotation offset standard deviation (degrees)	Float	4	variable
variable	Rotation Source	Source of rotation (see <i>Table 203: Source Status</i> on page 872)	Enum	4	variable
Next Rotation					

Field	Field Type	Description	Binary Format	Binary Bytes	Binary Offset
variable	xxxx	32-bit CRC (ASCII and Binary only)	Hex	4	variable
	[CR][LF]	Sentence terminator (ASCII only)	-	-	-

5.16 INSPOS

INS Position

Platform: OEM719, OEM729, OEM7500, OEM7600, OEM7700, OEM7720, PwrPak7, SPAN CPT7, SMART7-S, SMART7-SI

This log contains the most recent position measurements in WGS84 coordinates and includes an INS status indicator. The log reports the position at the IMU center, unless the **SETINSTRANSLATION USER** command was issued. See the **SETINSTRANSLATION** command on page 838.



This log provides the position information in WGS84.

Message ID: 265

Log Type: Synch

Recommended Input:

```
log insposa ontime 1
```

ASCII Example:

```
#INSPOSA,USB2,0,18.0,FINESTEERING,1541,487977.000,02040000,17cd,37343;1541,
487977.000549050,51.121315135,-114.042311349,1038.660737046,INS_SOLUTION_GOOD
*2ffffd557
```

Field	Field Type	Description	Format	Binary Bytes	Binary Offset
1	INSPOS Header	Log header. See <i>Messages</i> on page 27 for more information.	-	H	0
2	Week	GNSS Week	Ulong	4	H
3	Seconds into Week	Seconds from week start	Double	8	H+4
4	Latitude	Latitude (WGS84)	Double	8	H+12
5	Longitude	Longitude (WGS84)	Double	8	H+20
6	Height	Ellipsoidal Height (WGS84) [m]	Double	8	H+28
7	Status	INS status, see <i>Table 198: Inertial Solution Status</i> on page 863	Enum	4	H+36
8	xxxx	32-bit CRC (ASCII, Binary and Short Binary only)	Hex	4	H+40
9	[CR][LF]	Sentence terminator (ASCII only)	-	-	-

5.17 INSPOSS

Short INS Position

Platform: OEM719, OEM729, OEM7500, OEM7600, OEM7700, OEM7720, PwrPak7, SPAN CPT7, SMART7-S, SMART7-SI

This log is the short header version of the **INSPOS** log (see page 877).



This log provides the position information in WGS84.

Message ID: 321

Log Type: Synch

Recommended Input:

```
log inspossa ontime 1
```

ASCII Example:

```
%INSPOSSA,1541,487916.000;1541,487916.000549050,51.115797277,-114.037811065,1039.030700122,INS_SOLUTION_GOOD*5ca30894
```

Field	Field Type	Description	Format	Binary Bytes	Binary Offset
1	INSPOSS Header	Log header. See <i>Messages</i> on page 27 for more information.	-	H	0
2	Week	GNSS Week	Ulong	4	H
3	Seconds into Week	Seconds from week start	Double	8	H+4
4	Latitude	Latitude (WGS84)	Double	8	H+12
5	Longitude	Longitude (WGS84)	Double	8	H+20
6	Height	Ellipsoidal Height (WGS84) [m]	Double	8	H+28
7	Status	INS status, see <i>Table 198: Inertial Solution Status</i> on page 863	Enum	4	H+36
8	xxxx	32-bit CRC (ASCII, Binary and Short Binary only)	Hex	4	H+40
9	[CR][LF]	Sentence terminator (ASCII only)	-	-	-

5.18 INSPOSX

Inertial Position – Extended

Platform: OEM719, OEM729, OEM7500, OEM7600, OEM7700, OEM7720, PwrPak7, SPAN CPT7, SMART7-S, SMART7-SI

This log includes the information from the INSPOS log, as well as information about the position standard deviation. The position type and solution status fields indicate whether or not the corresponding data is valid.



The INSPOSX log is a large log and is not recommend for high rate logging. If you want to use high rate logging, log the **INSPOSS** log at a high rate and the **INSSTDEVS** log ontime 1.



This log provides the position information in the user datum. To determine the datum being used, log the **BESTPOS** log.

Message ID: 1459

Log Type: Synch

Recommended Input:

```
log insposxa ontime 1
```

ASCII example:

```
#INSPOSXA,COM1,0,79.0,FINESTEERING,1690,493465.000,02000040,7211,43441;  
INS_SOLUTION_GOOD,INS_PSRSP,51.11637750859,-114.03826206294,1049.1191,  
0.4883,0.4765,0.8853,3,0*dee048ab
```

Field	Field Type	Description	Format	Binary Bytes	Binary Offset
1	INSPOSX Header	Log header. See <i>Messages</i> on page 27 for more information.		H	0
2	INS Status	Solution status See <i>Table 198: Inertial Solution Status</i> on page 863	Enum	4	H
3	Pos Type	Position type See <i>Table 66: Position or Velocity Type</i> on page 375	Enum	4	H+4
4	Lat	Latitude	Double	8	H+8
5	Long	Longitude	Double	8	H+16
6	Height	Height above sea level (m)	Double	8	H+24

Field	Field Type	Description	Format	Binary Bytes	Binary Offset
7	Undulation	Undulation (m)	Float	4	H+32
8	Lat σ	Latitude standard deviation	Float	4	H+36
9	Long σ	Longitude standard deviation	Float	4	H+34
10	Height σ	Height standard deviation	Float	4	H+44
11	Ext sol stat	Extended solution status See <i>Table 199: Extended Solution Status</i> on page 868	Hex	4	H+48
11	Time Since Update	Elapsed time since the last ZUPT or position update (seconds)	Ushort	2	H+52
12	xxxx	32-bit CRC (ASCII and Binary only)	Hex	4	H+54
13	[CR][LF]	Sentence terminator (ASCII only)	-	-	-



The INS covariance and standard deviation values reported by the SPAN filter are an estimate of the Inertial filter solution quality. In lower accuracy GNSS position modes, such as SINGLE or WAAS (see *Table 66: Position or Velocity Type* on page 375), the position covariance and standard deviation values can appear to become optimistic compared with the absolute GNSS accuracy. This is due to the INS filter's ability to smooth short term noise in the GNSS solution, although the overall position error envelope still reflects the GNSS accuracy. Therefore, if the desired application requires absolute GNSS position accuracy, it is recommended to also monitor GNSS position messages such as BESTGNSSPOS (see **BESTGNSSPOS** log on page 846).

5.19 INSPVA

INS Position, Velocity and Attitude

Platform: OEM719, OEM729, OEM7500, OEM7600, OEM7700, OEM7720, PwrPak7, SPAN CPT7, SMART7-S, SMART7-SI

This log allows INS position, velocity and attitude, with respect to the SPAN frame, to be collected in one log, instead of using three separate logs. Refer to the **INSATT** log (see page 862) for an explanation of how the SPAN frame may differ from the IMU enclosure frame.



This log provides the position information in WGS84.

Message ID: 507

Log Type: Synch

Recommended Input:

```
log inspvaa ontime 1
```

ASCII Example:

```
#INSPVAA, COM1, 0, 31.0, FINESTEERING, 1264, 144088.000, 02040000, 5615, 1541; 1264,
144088.002284950, 51.116827527, -114.037738908, 401.191547167, 354.846489850,
108.429407241, -10.837482850, 1.116219952, -3.476059035, 7.372686190,
INS_ALIGNMENT_COMPLETE*af719fd9
```

Field	Field Type	Description	Format	Binary Bytes	Binary Offset
1	INSPVA Header	Log header. See <i>Messages</i> on page 27 for more information.	-	H	0
2	Week	GNSS Week	Ulong	4	H
3	Seconds	Seconds from week start	Double	8	H+4
4	Latitude	Latitude (WGS84) [degrees]	Double	8	H+12
5	Longitude	Longitude (WGS84) [degrees]	Double	8	H+20
6	Height	Ellipsoidal Height (WGS84) [m]	Double	8	H+28
7	North Velocity	Velocity in a northerly direction (a -ve value implies a southerly direction) [m/s]	Double	8	H+36
8	East Velocity	Velocity in an easterly direction (a -ve value implies a westerly direction) [m/s]	Double	8	H+44
9	Up Velocity	Velocity in an up direction [m/s]	Double	8	H+52
10	Roll	Right-handed rotation from local level around y-axis in degrees	Double	8	H+60

Field	Field Type	Description	Format	Binary Bytes	Binary Offset
11	Pitch	Right-handed rotation from local level around x-axis in degrees	Double	8	H+68
12	Azimuth	Left-handed rotation around z-axis in degrees clockwise from North This is the inertial azimuth calculated from the IMU gyros and the SPAN filters.	Double	8	H+76
13	Status	INS Status, see <i>Table 198: Inertial Solution Status</i> on page 863	Enum	4	H+84
14	xxxx	32-bit CRC	Hex	4	H+88
15	[CR][LF]	Sentence Terminator (ASCII only)	-	-	-

5.20 INSPVACMP

Compressed version of the INSPVA log for CAN

Platform: OEM719, OEM729, OEM7500, OEM7600, OEM7700, OEM7720, PwrPak7, SPAN CPT7, SMART7-S, SMART7-SI

This log contains the **INSPVA** log (see page 881) information compressed as a NMEA 2000 fast packet message for CAN output. The information in the table below is the data portion of the INSPVACMP NMEA 2000 message. Refer to the *NATIONAL MARINE ELECTRONICS ASSOCIATION (NMEA) NMEA2000(r) rev 2.0 - January/2013* document for full details on this message output and the NMEA 2000 fast packet protocol.

Message ID: 1889

Log Type: Synch

Abbreviated ASCII Syntax:

```
LOG CCOM1 INSPVACMP ONTIME 1
```

Field	Field Type	Description	Format	Binary Bytes	Units	Scale Factor
1	Message Time	Seconds from week start	Long	4	seconds	0.001
2	INS Status	INS solution status (see <i>Table 198: Inertial Solution Status</i> on page 863)	UChar	1	N/A	N/A
3	GNSS Position Type	GNSS position type (see <i>Table 66: Position or Velocity Type</i> on page 375)	UChar	1	N/A	N/A
4	Latitude	Latitude (WGS84)	5 byte Long	5	degrees	180/239
5	Longitude	Longitude (WGS84)	5 byte Long	5	degrees	180/239
6	Height	Ellipsoidal Height (WGS84)	Long	4	meters	0.0001
7	North Velocity	Velocity in a northerly direction (a -ve value implies a southerly direction)	Short	2	m/s	0.002
8	East Velocity	Velocity in an easterly direction (a -ve value implies a westerly direction)	Short	2	m/s	0.002
9	Up Velocity	Velocity in an up direction	Short	2	m/s	0.002
10	Roll	Right-handed rotation from local level around y axis	Short	2	degrees	0.01

Field	Field Type	Description	Format	Binary Bytes	Units	Scale Factor
11	Pitch	Right-handed rotation from local level around x axis	Short	2	degrees	0.01
12	Azimuth	Left-handed rotation around z-axis clockwise from North This is the inertial azimuth calculated from the IMU gyros and the SPAN filters.	Ushort	2	degrees	0.01
13	Azimuth Rate	Rate of change of the Azimuth	Short	2	degrees/s	0.01

5.21 INSPVAS

Short INS Position, Velocity and Attitude

Platform: OEM719, OEM729, OEM7500, OEM7600, OEM7700, OEM7720, PwrPak7, SPAN CPT7, SMART7-S, SMART7-SI

This log is the short header version of the **INSPVA** log (see page 881).



This log provides the position information in WGS84.

Message ID: 508

Log Type: Synch

Recommended Input:

```
log inspvasa ontime 1
```

ASCII Example:

```
%INSPVASA,1264,144059.000;1264,144059.002135700,51.116680071,-114.037929194,
515.286704183,277.896368884,84.915188605,-8.488207941,0.759619515,-2.892414901,
6.179554750,INS_ALIGNMENT_COMPLETE*855d6f76
```

Field	Field Type	Description	Format	Binary Bytes	Binary Offset
1	INSPVAS Header	Log header. See <i>Messages</i> on page 27 for more information.	-	H	0
2	Week	GNSS Week	Ulong	4	H
3	Seconds	Seconds from week start	Double	8	H+4
4	Latitude	Latitude (WGS84) [degrees]	Double	8	H+12
5	Longitude	Longitude (WGS84) [degrees]	Double	8	H+20
6	Height	Ellipsoidal Height (WGS84) [m]	Double	8	H+28
7	North Velocity	Velocity in a northerly direction (a -ve value implies a southerly direction) [m/s]	Double	8	H+36
8	East Velocity	Velocity in an easterly direction (a -ve value implies a westerly direction) [m/s]	Double	8	H+44
9	Up Velocity	Velocity in an up direction [m/s]	Double	8	H+52
10	Roll	Right-handed rotation from local level around y-axis in degrees	Double	8	H+60
11	Pitch	Right-handed rotation from local level around x-axis in degrees	Double	8	H+68

Field	Field Type	Description	Format	Binary Bytes	Binary Offset
12	Azimuth	Left-handed rotation around z-axis in degrees clockwise from north This is the inertial azimuth calculated from the IMU gyros and the SPAN filters.	Double	8	H+76
13	Status	INS Status, see <i>Table 198: Inertial Solution Status</i> on page 863	Enum	4	H+84
14	xxxx	32-bit CRC	Hex	4	H+88
15	[CR][LF]	Sentence Terminator (ASCII only)	-	-	-

5.22 INSPVASDCMP

Standard deviation information for the INSPVACMP CAN message

Platform: OEM719, OEM729, OEM7500, OEM7600, OEM7700, OEM7720, PwrPak7, SPAN CPT7, SMART7-S, SMART7-SI

This log contains the standard deviation information for the **INSPVACMP** log (see page 883) information compressed in a NMEA 2000 fast packet message for CAN output. The information in the table below is the data portion of the INSPVASDCMP NMEA 2000 message. Refer to the *NATIONAL MARINE ELECTRONICS ASSOCIATION (NMEA) NMEA2000(r) rev 2.0 - January/2013* document for full details on this message output and the NMEA 2000 fast packet protocol.

Message ID: 1890

LogType: Synch

Abbreviated ASCII Syntax:

LOG CCOM1 INSPVASDCMP ONTIME 1

Field	Field Type	Description	Format	Binary Bytes	Units	Scale Format
1	Week	GNSS Week	Ushort	2	weeks	1
2	Message Time	Seconds from week start	Ulong	4	seconds	0.001
3	Sigma Latitude	Latitude Standard Deviation	Ushort	2	meters	0.001
4	Sigma Longitude	Longitude Standard Deviation	Ushort	2	meters	0.001
5	Sigma Height	Height Standard Deviation	Ushort	2	meters	0.001
6	Sigma North Velocity	North Velocity Standard Deviation	Ushort	2	m/s	0.001
7	Sigma East Velocity	East Velocity Standard Deviation	Ushort	2	m/s	0.001
8	Sigma Up Velocity	Up Velocity Standard Deviation	Ushort	2	m/s	0.001
9	Sigma Roll	Roll Standard Deviation	Ushort	2	degrees	0.01
10	Sigma Pitch	Pitch Standard Deviation	Ushort	2	degrees	0.01
11	Sigma Azimuth	Azimuth Standard Deviation	Ushort	2	degrees	0.01

Field	Field Type	Description	Format	Binary Bytes	Units	Scale Format
12	Update Counter	Elapsed time since the last ZUPT or position update	Uchar	1	seconds	1
13	Position Type	GNSS position type (see <i>Table 66: Position or Velocity Type</i> on page 375)	Uchar	1	N/A	N/A
14	Extended Solution Status	Extended Solution Status (see <i>Table 199: Extended Solution Status</i> on page 868)	Hex	4	N/A	N/A
15	ALIGN Age	Elapsed time since a valid ROVERPOS solution was available	Uchar	1	seconds	1

5.23 INSPVAX

Inertial PVA – Extended

Platform: OEM719, OEM729, OEM7500, OEM7600, OEM7700, OEM7720, PwrPak7, SPAN CPT7, SMART7-S, SMART7-SI

This log includes the information from the INSPVA log, as well as information about the position standard deviation. The position type and solution status fields indicate whether or not the corresponding data is valid.



The INSPVAX log is a large log and is not recommend for high rate logging.

If you want to use high rate logging, log the **INSPVAS** log (see page 885) at a high rate and the **INSSTDEV** log on page 898 ontime 1.



This log provides the position information in the user datum.

To determine the datum being used, log the **BESTPOS** log.

Message ID: 1465

Log Type: Synch

Recommended Input:

```
log inspvaxa ontime 1
```

ASCII example:

```
#INSPVAXA,COM1,0,73.5,FINESTEERING,1695,309428.000,02000040,4e77,43562;
INS_SOLUTION_GOOD,INS_PSRSP,51.11637873403,-114.03825114994,1063.6093,-16.9000,
-0.0845,-0.0464,-0.0127,0.138023492,0.069459386,90.000923268,0.9428,0.6688,
1.4746,0.0430,0.0518,0.0521,0.944295466,0.944567084,1.000131845,3,0*e877c178
```

Field	Field Type	Data Description	Format	Binary Bytes	Binary Offset
1	INSPVAX Header	Log header. See <i>Messages</i> on page 27 for more information.		H	0
2	INS Status	Solution status See <i>Table 198: Inertial Solution Status</i> on page 863	Enum	4	H
3	Pos Type	Position type See <i>Table 66: Position or Velocity Type</i> on page 375	Enum	4	H+4
4	Lat	Latitude (degrees)	Double	8	H+8
5	Long	Longitude (degrees)	Double	8	H+16
6	Height	Height above mean sea level (m)	Double	8	H+24

Field	Field Type	Data Description	Format	Binary Bytes	Binary Offset
7	Undulation	Undulation (m)	Float	4	H+32
8	North Vel	North velocity (m/s)	Double	8	H+36
9	East Vel	East velocity (m/s)	Double	8	H+44
10	Up Vel	Up velocity (m/s)	Double	8	H+52
11	Roll	Roll in Local Level (degrees)	Double	8	H+60
12	Pitch	Pitch in Local Level (degrees)	Double	8	H+68
13	Azimuth	Azimuth in Local Level (degrees) This is the inertial azimuth calculated from the IMU gyros and the SPAN filters.	Double	8	H+76
14	Lat σ	Latitude standard deviation (m)	Float	4	H+84
15	Long σ	Longitude standard deviation (m)	Float	4	H+88
16	Height σ	Height standard deviation (m)	Float	4	H+92
17	North Vel σ	North velocity standard deviation (m/s)	Float	4	H+96
18	East Vel σ	East velocity standard deviation (m/s)	Float	4	H+100
19	Up Vel σ	Up velocity standard deviation (m/s)	Float	4	H+104
20	Roll σ	Roll standard deviation (degrees)	Float	4	H+108
21	Pitch σ	Pitch standard deviation (degrees)	Float	4	H+112
22	Azimuth σ	Azimuth standard deviation (degrees)	Float	4	H+116
23	Ext sol stat	Extended solution status See <i>Table 199: Extended Solution Status</i> on page 868	Hex	4	H+120
24	Time Since Update	Elapsed time since the last ZUPT or position update (seconds)	Ushort	2	H+124
25	xxxx	32-bit CRC (ASCII and Binary only)	Hex	4	H+126
26	[CR][LF]	Sentence terminator (ASCII only)	-	-	-



The INS covariance and standard deviation values reported by the SPAN filter are an estimate of the Inertial filter solution quality. In lower accuracy GNSS position modes, such as SINGLE or WAAS (see *Table 66: Position or Velocity Type* on page 375), the position covariance and standard deviation values can appear to become optimistic compared with the absolute GNSS accuracy. This is due to the INS filter's ability to smooth short term noise in the GNSS solution, although the overall position error envelope still reflects the GNSS accuracy. Therefore, if the desired application requires absolute GNSS position accuracy, it is recommended to also monitor GNSS position messages such as BESTGNSSPOS (see **BESTGNSSPOS** log on page 846).

5.24 INSSEEDSTATUS

Status of INS Seed

Platform: OEM719, OEM729, OEM7500, OEM7600, OEM7700, OEM7720, PwrPak7, SPAN CPT7, SMART7-S, SMART7-SI

This log reports the current status of the INS Seed. See the [OEM7 SPAN Installation and Operation User Manual](#) for more information about an INS Seed.

Message ID: 2129

Log Type: Asynch

Abbreviated ASCII Syntax:

```
log insseedstatusa onnew
```

Example:

```
#INSSEEDSTATUSA,COM3,0,66.0,FINESTEERING,1945,315811.009,02040020,9fd0,32768;
INJECTED,ALLVALID,-0.098151498,0.298816800,95.888587952,
-1634544.0523482216522098,-3664556.8064546003006399,
4942534.6315599447116256,-16.9000,0,0,0,0*f353470c
```

Field	Field Type	Description	Format	Binary Bytes	Binary Offset
1	INSSEEDSTATUS header	Command header. See <i>Messages</i> on page 27 for more information.	-	H	0
2	Injection Status	Status of the INS Seed being injected into the solution. See <i>Table 204: Injection Status</i> on the next page	Enum	4	H
3	Validity Status	Flag to indicate if current seed data in NVM is valid. See <i>Table 205: Validity Status</i> on the next page	Bool	4	H+4
4	Pitch	IMU frame pitch angle (degrees)	Float	4	H+8
5	Roll	IMU frame roll angle (degrees)	Float	4	H+12
6	Azimuth	IMU frame azimuth angle (degrees)	Float	4	H+16
7	PositionX	ECEF-based x-coordinate	Double	8	H+20
8	PositionY	ECEF-based y-coordinate	Double	8	H+28
9	PositionZ	ECEF-based z-coordinate	Double	8	H+36
10	Undulation	Geoid undulation	Float	4	H+44
11	Reserved		Ulong	4	H+48
12	Reserved		Ulong	4	H+52

Field	Field Type	Description	Format	Binary Bytes	Binary Offset
13	Reserved		Ulong	4	H+56
14	Reserved		Ulong	4	H+60
15	xxxx	32-bit CRC (ASCII and Binary only)	Hex	4	H+64
16	[CR][LF]	Sentence Terminator (ASCII only)	-	-	-

Table 204: Injection Status

Binary	ASCII	Description
0	NOT_INITIALIZED	INS Seed has not been injected into the solution
1	INVALID	Valid INS Seed was not found in non-volatile memory
2	FAILED	INS Seed has failed validation and has been discarded
3	PENDING	INS Seed is awaiting validation
4	INJECTED	INS Seed alignment data has successfully been injected (including error model data)
5	IGNORED	INS Seed was pending, but has been ignored due to a user commanded filter reset or configuration change
6	ERRORMODELINJECTED	INS Seed error model data has successfully been injected

Table 205: Validity Status

Binary	ASCII	Description
0	INVALID	INS Seed in NVM is not valid
1	ALLVALID	INS Seed in NVM is valid
2	ERRORMODELVALID	INS Seed error model in NVM is valid (alignment data is not valid)

5.25 INSSPD

INS Speed

Platform: OEM719, OEM729, OEM7500, OEM7600, OEM7700, OEM7720, PwrPak7, SPAN CPT7, SMART7-S, SMART7-SI

This log contains the most recent speed measurements in the horizontal and vertical directions and includes an INS status indicator.

Message ID: 266

Log Type: Synch

Recommended Input:

```
log insspda ontime 1
```

ASCII Example:

```
#INSSPDA,USB2,0,20.0,FINESTEERING,1541,487969.000,02040000,7832,37343;1541,4879
69.000549050,329.621116190,14.182070674,-0.126606551,INS_SOLUTION_GOOD
*c274fff2
```

Field	Field Type	Description	Format	Binary Bytes	Binary Offset
1	INSSPD Header	Log header. See <i>Messages</i> on page 27 for more information.	-	H	0
2	Week	GNSS Week	Ulong	4	H
3	Seconds into Week	Seconds from week start	Double	8	H+4
4	Trk gnd	Actual direction of motion over ground (track over ground) with respect to True North, in degrees The track over ground is determined by comparing the current position determined from the GNSS/INS solution with the previously determined position. Track over ground is best used when the vehicle is moving. When the vehicle is stationary, position error can make the direction of motion appear to change randomly.	Double	8	H+12
5	Horizontal Speed	Magnitude of horizontal speed in m/s.	Double	8	H+20
6	Vertical Speed	Magnitude of vertical speed in m/s where a positive value indicates speed upward and a negative value indicates speed downward.	Double	8	H+28

Field	Field Type	Description	Format	Binary Bytes	Binary Offset
7	Status	INS status, see <i>Table 198: Inertial Solution Status</i> on page 863	Enum	4	H+36
8	xxxx	32-bit CRC (ASCII, Binary and Short Binary only)	Hex	4	H+40
9	[CR][LF]	Sentence terminator (ASCII only)	-	-	-

5.26 INSSPDS

Short INS Speed

Platform: OEM719, OEM729, OEM7500, OEM7600, OEM7700, OEM7720, PwrPak7, SPAN CPT7, SMART7-S, SMART7-SI

This log is the short header version of the **INSSPD** log (see page 894).

Message ID: 323

Log Type: Synch

Recommended Input:

```
log insspdsa ontime 1
```

ASCII Example:

```
%INSSPDSA,1541,487975.000;1541,487975.000549050,323.101450813,9.787233999,-0.038980077,INS_SOLUTION_GOOD*105ba028
```

Field	Field Type	Description	Format	Binary Bytes	Binary Offset
1	INSSPDS Header	Log header. See <i>Messages</i> on page 27 for more information.	-	H	0
2	Week	GNSS Week	Ulong	4	H
3	Seconds into Week	Seconds from week start	Double	8	H+4
4	Trk gnd	Actual direction of motion over ground (track over ground) with respect to True North, in degrees. The track over ground is determined by comparing the current position determined from the GNSS/INS solution with the previously determined position. Track over ground is best used when the vehicle is moving. When the vehicle is stationary, position error can make the direction of motion appear to change randomly.	Double	8	H+12
5	Horizontal Speed	Magnitude of horizontal speed in m/s.	Double	8	H+20
6	Vertical Speed	Magnitude of vertical speed in m/s where a positive value indicates speed upward and a negative value indicates speed downward.	Double	8	H+28
7	Status	INS status, see <i>Table 198: Inertial Solution Status</i> on page 863	Enum	4	H+36

Field	Field Type	Description	Format	Binary Bytes	Binary Offset
8	xxxx	32-bit CRC (ASCII, Binary and Short Binary only)	Hex	4	H+40
9	[CR][LF]	Sentence terminator (ASCII only)	-	-	-

5.27 INSSTDEV

INS PVA standard deviations

Platform: OEM719, OEM729, OEM7500, OEM7600, OEM7700, OEM7720, PwrPak7, SPAN CPT7, SMART7-S, SMART7-SI

This log displays the INS PVA standard deviations.

Message ID: 2051

Log Type: Synch

Abbreviated ASCII Syntax:

```
log insstdev ontime 1
```

ASCII Example:

```
#INSSTDEVA,COM1,0,78.0,FINESTEERING,1907,233990.000,02000020,3e6d,32768;0.4372,
0.3139,0.7547,0.0015,0.0015,0.0014,3.7503,3.7534,5.1857,26000005,0,0,01ffd1bf,0
*3deca7d2
```

Field	Field Type	Description	Binary Format	Binary Bytes	Binary Offset
1	INSSTDEV Header	Log header. See <i>Messages</i> on page 27 for more information.	-	H	0
2	Latitude σ	Latitude standard deviation (m)	Float	4	H
3	Longitude σ	Longitude standard deviation (m)	Float	4	H+4
4	Height σ	Height standard deviation (m)	Float	4	H+8
5	North Velocity σ	North velocity standard deviation (m/s)	Float	4	H+12
6	East Velocity σ	East velocity standard deviation (m/s)	Float	4	H+16
7	Up Velocity σ	Up velocity standard deviation (m/s)	Float	4	H+20
8	Roll σ	Roll standard deviation (degrees)	Float	4	H+24
9	Pitch σ	Pitch standard deviation (degrees)	Float	4	H+28
10	Azimuth σ	Azimuth standard deviation (degrees)	Float	4	H+32
11	Ext sol stat	Extended solution status See <i>Table 199: Extended Solution Status</i> on page 868	Ulong	4	H+36
12	Time Since Update	Elapsed time since the last ZUPT or position update (seconds)	Ushort	2	H+40

Field	Field Type	Description	Binary Format	Binary Bytes	Binary Offset
13	Reserved		Ushort	2	H+42
14	Reserved		Ulong	4	H+44
15	Reserved		Ulong	4	H+48
16	xxxx	32-bit CRC (ASCII and Binary only).	Hex	4	H+52
17	[CR][LF]	Sentence terminator (ASCII only).	-	-	-

5.28 INSSTDEVS

Short INS PVA standard deviations

Platform: OEM719, OEM729, OEM7500, OEM7600, OEM7700, OEM7720, PwrPak7, SPAN CPT7, SMART7-S, SMART7-SI

This log is the short header version of the **INSSTDEV** log (see page 898).

Message ID: 2052

Log Type: Synch

Abbreviated ASCII Syntax:

```
log insstdevs ontime 1
```

ASCII Example:

```
%INSSTDEVSA,1907,233990.000;0.4372,0.3139,0.7547,0.0015,0.0015,0.0014,3.7503,3.7534,5.1857,26000005,0,0,01ffd1bf,0*2c967ced
```

Field	Field Type	Description	Binary Format	Binary Bytes	Binary Offset
1	INSSTDEV Header	Log header. See <i>Messages</i> on page 27 for more information.	-	H	0
2	Latitude σ	Latitude standard deviation (m)	Float	4	H
3	Longitude σ	Longitude standard deviation (m)	Float	4	H+4
4	Height σ	Height standard deviation (m)	Float	4	H+8
5	North Velocity σ	North velocity standard deviation (m/s)	Float	4	H+12
6	East Velocity σ	East velocity standard deviation (m/s)	Float	4	H+16
7	Up Velocity σ	Up velocity standard deviation (m/s)	Float	4	H+20
8	Roll σ	Roll standard deviation (degrees)	Float	4	H+24
9	Pitch σ	Pitch standard deviation (degrees)	Float	4	H+28
10	Azimuth σ	Azimuth standard deviation (degrees)	Float	4	H+32
11	Ext sol stat	Extended solution status See <i>Table 199: Extended Solution Status</i> on page 868	Ulong	4	H+36
12	Time Since Update	Elapsed time since the last ZUPT or position update (seconds)	Ushort	2	H+40
13	Reserved		Ushort	2	H+42

Field	Field Type	Description	Binary Format	Binary Bytes	Binary Offset
14	Reserved		Ulong	4	H+44
15	Reserved		Ulong	4	H+48
16	xxxx	32-bit CRC (ASCII and Binary only).	Hex	4	H+52
17	[CR][LF]	Sentence terminator (ASCII only).	-	-	-

5.29 INSUPDATESTATUS

INS Update Status

Platform: OEM719, OEM729, OEM7500, OEM7600, OEM7700, OEM7720, PwrPak7, SPAN CPT7, SMART7-S, SMART7-SI

This log provides the most recent INS update information. It provides information about what updates were performed in the INS filter at the last update epoch and a wheel sensor status indicator.

Message ID: 1825

Log Type: Asynch

Recommended Input:

```
log insupdatestatus onchanged
```

ASCII Example:

```
#INSUPDATESTATUSA,COM2,0,76.0,FINESTEERING,1934,149288.000,02000000,78f1,32768;SINGLE,0,0,0,INACTIVE,INACTIVE,00000005,00ffd1bf,0,0*d6b7ee02
```

Field	Field Type	Description	Format	Binary Bytes	Binary Offset
1	INSUPDATE STATUS Header	Log header. See <i>Messages</i> on page 27 for more information.	-	H	0
2	PosType	Type of GNSS solution used for the last INS filter update. See <i>Table 66: Position or Velocity Type</i> on page 375	Enum	4	H
3	NumPSR	Number of raw pseudorange observations used in the last INS filter update.	Integer	4	H+4
4	NumADR	Number of raw phase observations used in the last INS filter update.	Integer	4	H+8
5	NumDOP	Number of raw doppler observations used in the last INS filter update.	Integer	4	H+12
6	DMI Update Status	Distance measurement instrument (wheel sensor) status. See <i>Table 206: DMI Update Status</i> on the next page.	Enum	4	H+16
7	Heading Update Status	Status of the heading update during the last INS filter update. See <i>Table 207: Heading Update Values</i> on the next page	Enum	4	H+20

Field	Field Type	Description	Format	Binary Bytes	Binary Offset
8	Ext sol stat	Extended solution status See <i>Table 199: Extended Solution Status</i> on page 868	Hex	4	H+24
9	INS Enabled Updates	Enabled INS updates. See <i>Table 208: INS Update Values</i> on the next page	Hex	4	H+28
10	Reserved		Ulong	4	H+32
11	Reserved		Ulong	4	H+36
12	xxxx	32-bit CRC (ASCII, Binary and Short Binary only)	Hex	4	H+40
13	[CR][LF]	Sentence terminator (ASCII only)	-	-	-

Table 206: DMI Update Status

Binary	ASCII	Description
0	INACTIVE	The DMI sensor is not connected.
1	ACTIVE	The DMI sensor is connected but not used.
2	USED	The DMI sensor is connected and used in the INS solution.
3	RESERVED	Reserved
4	BAD_MISC	The measurement of the DMI sensor resulted in bad misclosure and was rejected.
5	HIGH_ROTATION	The measurement of the DMI sensor was not used because the system is undergoing high rotation.
6	DISABLED	DMI updates are disabled.
7	ZUPT	The DMI update reported zero velocity.

Table 207: Heading Update Values

Binary	ASCII	Description
0	INACTIVE	A heading update was not available.
1	ACTIVE	Heading updates are running, but the epoch is not used as an update. When all other rejection criteria pass, a heading update will still only be applied once every 5 seconds (20 seconds when stationary).
2	USED	The update for that epoch was taken.
5	HEADING_UPDATE_BAD_MISC	Heading updates are running, but was not performed this epoch due to a large disagreement with filter estimates.

Table 208: INS Update Values

Nibble	Bit	Mask	Description	Range Value
N0	0	0x00000001	Position update	0 = Disabled 1 = Enabled
	1	0x00000002	Phase update	0 = Disabled 1 = Enabled
	2	0x00000004	Zero velocity update	0 = Disabled 1 = Enabled
	3	0x00000008	Wheel sensor update	0 = Disabled 1 = Enabled
N1	4	0x00000010	ALIGN (heading) update	0 = Disabled 1 = Enabled
	5	0x00000020	External position update	0 = Disabled 1 = Enabled
	6	0x00000040	Reserved	
	7	0x00000080	Doppler update	0 = Disabled 1 = Enabled
N2	8	0x00000100	Pseudorange update	0 = Disabled 1 = Enabled
	9	0x00000200	Velocity update	0 = Disabled 1 = Enabled
	10	0x00000400	Reserved	
	11	0x00000800	Dead reckoning update	0 = Disabled 1 = Enabled
N3	12	0x00001000	Phase wind up update	0 = Disabled 1 = Enabled
	13	0x00002000	Course over ground update	0 = Disabled 1 = Enabled
	14	0x00004000	External velocity update	0 = Disabled 1 = Enabled
	15	0x00008000	External attitude update	0 = Disabled 1 = Enabled

Nibble	Bit	Mask	Description	Range Value
N4	16	0x00010000	External heading update	0 = Disabled 1 = Enabled
	17	0x00020000	External height update	0 = Disabled 1 = Enabled
	18	0x00040000	Reserved	
	19	0x00080000	Reserved	

5.30 INSVEL

INS Velocity

Platform: OEM719, OEM729, OEM7500, OEM7600, OEM7700, OEM7720, PwrPak7, SPAN CPT7, SMART7-S, SMART7-SI

This log contains the most recent North, East and Up velocity vector values, with respect to the local level frame and also includes an INS status indicator.

Message ID: 267

Log Type: Synch

Recommended Input:

```
log insvela ontime 1
```

ASCII Example:

```
#INSVELA,USB1,0,19.0,FINESTEERING,1543,236173.000,02000000,9c95,37343;1543,236173.002500000,14.139471871,-0.070354464,-0.044204369,INS_SOLUTION_GOOD*3c37c0fc
```

Field	Field Type	Description	Format	Binary Bytes	Binary Offset
1	INSVEL Header	Log header. See <i>Messages</i> on page 27 for more information.	-	H	0
2	Week	GNSS Week	Ulong	4	H
3	Seconds into Week	Seconds from week start	Double	8	H+4
4	North Velocity	Velocity North in m/s	Double	8	H+12
5	East Velocity	Velocity East in m/s	Double	8	H+20
6	Up Velocity	Velocity Up in m/s	Double	8	H+28
7	Status	INS status, see <i>Table 198: Inertial Solution Status</i> on page 863	Enum	4	H+36
8	xxxx	32-bit CRC (ASCII, Binary and Short Binary only)	Hex	4	H+40
9	[CR][LF]	Sentence terminator (ASCII only)	-	-	-

5.31 INSVELS

Short INS Velocity

Platform: OEM719, OEM729, OEM7500, OEM7600, OEM7700, OEM7720, PwrPak7, SPAN CPT7, SMART7-S, SMART7-SI

This log is the short header version of the **INSVEL** log (see page 906).

Message ID: 324

Log Type: Synch

Recommended Input:

```
log insvelsa ontime 1
```

ASCII Example:

```
%INSVELSA,1921,152855.200;1921,152855.200000000,0.1077,-9.8326,-0.1504,INS_
SOLUTION_GOOD*efd71f65
```

Field	Field Type	Description	Format	Binary Bytes	Binary Offset
1	INSVELS Header	Log header. See <i>Messages</i> on page 27 for more information.	-	H	0
2	Week	GNSS Week	Ulong	4	H
3	Seconds into Week	Seconds from week start	Double	8	H+4
4	North Velocity	Velocity North m/s	Double	8	H+12
5	East Velocity	Velocity East m/s	Double	8	H+20
6	Up Velocity	Velocity Up m/s	Double	8	H+28
7	Status	INS status, see <i>Table 198: Inertial Solution Status</i> on page 863	Enum	4	H+36
8	xxxx	32-bit CRC (ASCII, Binary and Short Binary only)	Hex	4	H+40
9	[CR][LF]	Sentence terminator (ASCII only)	-	-	-

5.32 INSVELX

Inertial Velocity – Extended

Platform: OEM719, OEM729, OEM7500, OEM7600, OEM7700, OEM7720, PwrPak7, SPAN CPT7, SMART7-S, SMART7-SI

This log includes the information from the INSVEL log, as well as information about the velocity standard deviation. The position type and solution status fields indicate whether or not the corresponding data is valid.



The INSVELX log is a large log and is not recommend for high rate logging.

If you want to use high rate logging, log the **INSVELS** log at a high rate and the **INSSTDEVS** log ontime 1.

Message ID: 1458

Log Type: Synch

Recommended Input:

```
log insvelxa ontime 1
```

ASCII example:

```
#INSVELXA,COM1,0,80.0,FINESTEERING,1690,494394.000,02000040,1f8e,43441;  
INS_ALIGNMENT_COMPLETE,INS_PSRSP,0.0086,0.0015,0.0215,0.0549,0.0330,0.0339,  
3,0*ec33e372
```

Field	Field Type	Description	Format	Binary Bytes	Binary Offset
1	INSVELX Header	Log header. See <i>Messages</i> on page 27 for more information.		H	0
2	INS Status	Solution status See <i>Table 198: Inertial Solution Status</i> on page 863	Enum	4	H
3	Pos Type	Position type See <i>Table 66: Position or Velocity Type</i> on page 375	Enum	4	H+4
4	North Vel	North velocity (m/s)	Double	8	H+8
5	East Vel	East velocity (m/s)	Double	8	H+16
6	Up Vel	Up velocity (m/s)	Double	8	H+24
7	North Vel σ	North velocity standard deviation (m/s)	Float	4	H+32
8	East Vel σ	East velocity standard deviation (m/s)	Float	4	H+36
9	Up Vel σ	Up velocity standard deviation (m/s)	Float	4	H+40

Field	Field Type	Description	Format	Binary Bytes	Binary Offset
10	Ext sol stat	Extended solution status See <i>Table 199: Extended Solution Status</i> on page 868	Hex	4	H+44
11	Time Since Update	Elapsed time since the last ZUPT or position update (seconds)	Ushort	2	H+48
11	xxxx	32-bit CRC (ASCII and Binary only)	Hex	4	H+50
12	[CR][LF]	Sentence terminator (ASCII only)	-	-	-

5.33 RAWIMU

Raw IMU Data

Platform: OEM719, OEM729, OEM7500, OEM7600, OEM7700, OEM7720, PwrPak7, SPAN CPT7, SMART7-S, SMART7-SI

This log contains an IMU status indicator and the measurements from the accelerometers and gyros with respect to the IMU enclosure frame. If logging this data, consider the **RAWIMUS** log (see page 929) to reduce the amount of data.



The change in velocity (acceleration) and angle (rotation rate) scale factors for each IMU type can be found in *Table 221: Raw IMU Scale Factors* on page 931. Multiply the appropriate scale factor by the count value for the velocity (field 5-7) and angle (field 8-10) increments.



To obtain acceleration in m/s/s or rotation rate in rad/s, multiply the velocity/rotation increments by the output rate of the IMU:

- 100 Hz for HG1700, HG1900, HG1930 and HG4930
- 125 Hz for STIM300, G320N, PwrPak7-E1, PwrPak7D-E1 and SMART7-S
- 200 Hz for ISA-100C, iMAR-FSAS, LN200, KVH1750, ADIS16488, G370N, G320N_200Hz, PwrPak7-E2 and PwrPak7D-E2

The units of acceleration and rotation rate will depend on the IMU Scale Factors.



This log is output in the IMU Body frame.

Message ID: 268

Log Type: Asynch

Recommended Input:

```
log rawimua onnew
```

ASCII Example:

```
#RAWIMUA,COM1,0,68.5,FINESTEERING,1724,219418.009,024c0040,6125,30019;1724,219418.008755000,00000077,64732,56,298,8,28,-3*7378486f
```

Field	Field Type	Description	Format	Binary Bytes	Binary Offset
1	RAWIMU Header	Log header. See <i>Messages</i> on page 27 for more information.	-	H	0
2	Week	GNSS Week	Ulong	4	H

Field	Field Type	Description	Format	Binary Bytes	Binary Offset
3	Seconds into Week	Seconds from week start	Double	8	H+4
4	IMU Status	<p>The status of the IMU. This field is given in a fixed length (n) array of bytes in binary but in ASCII or Abbreviated ASCII is converted into 2 character hexadecimal pairs.</p> <p>For the raw IMU status, see one of the following tables:</p> <ul style="list-style-type: none"> • <i>Table 209: iIMU-FSAS IMU Status</i> on the next page • <i>Table 210: HG1700 IMU Status</i> on page 913 • <i>Table 211: LN200 IMU Status</i> on page 915 • <i>Table 212: ISA-100C IMU Status</i> on page 916 • <i>Table 213: IMU-CPT IMU Status</i> on page 917 • <i>Table 214: IMU-KVH1750 IMU Status</i> on page 919 • <i>Table 215: HG1900 and HG1930 IMU Status</i> on page 920 • <i>Table 216: HG4930 IMU Status</i> on page 922 • <i>Table 217: ADIS16488 and IMU-IGM-A1 IMU Status</i> on page 923 • <i>Table 218: STIM300 and IMU-IGM-S1 IMU Status</i> on page 924 • <i>Table 219: μIMU IMU Status</i> on page 926 • <i>Table 220: G320N and G370N IMU Status</i> on page 927 <p>Also refer to Interface Control Documentation as provided by Honeywell or Northrop Grumman.</p>	Hex Ulong	4	H+12
5	Z Accel Output	Change in velocity count along z axis	Long	4	H+16
6	- (Y Accel Output)	<p>- (Change in velocity count along y axis)</p> <p>A negative value implies the output is along the positive y-axis marked on the IMU. A positive value implies the change is in the direction opposite to that of the y-axis marked on the IMU.</p>	Long	4	H+20

Field	Field Type	Description	Format	Binary Bytes	Binary Offset
7	X Accel Output	Change in velocity count along x axis	Long	4	H+24
8	Z Gyro Output	Change in angle count around z axis. Right-handed	Long	4	H+28
9	- (Y Gyro Output)	- (Change in angle count around y axis). Right-handed A negative value implies the output is along the positive y-axis marked on the IMU. A positive value implies the change is in the direction opposite to that of the y-axis marked on the IMU.	Long	4	H+32
10	X Gyro Output	Change in angle count around x axis. Right-handed	Long	4	H+36
11	xxxx	32-bit CRC (ASCII, Binary and Short Binary only)	Hex	4	H+40
12	[CR][LF]	Sentence terminator (ASCII only)	-	-	-

Table 209: iIMU-FSAS IMU Status

Nibble	Bit	Mask	Description	Range Value
N0	0	0x00000001	Reserved	
	1	0x00000002		
	2	0x00000004		
	3	0x00000008		
N1	4	0x00000010	Gyro warm-up	0 = Passed, 1 = Failed
	5	0x00000020	Gyro self-test active	0 = Passed, 1 = Failed
	6	0x00000040	Gyro status bit set	0 = Passed, 1 = Failed
	7	0x00000080	Gyro time-out command interface	0 = Passed, 1 = Failed
N2	8	0x00000100	Power-up built-in test (PBIT)	0 = Passed, 1 = Failed
	9	0x00000200	Reserved	
	10	0x00000400	Interrupt	0 = Passed, 1 = Failed
	11	0x00000800	Reserved	

Nibble	Bit	Mask	Description	Range Value
N3	12	0x00001000	Warm-up	0 = Passed, 1 = Failed
	13	0x00002000	Reserved	
	14	0x00004000		
	15	0x00008000	Initiated built-in test (IBIT)	0 = Passed, 1 = Failed
N4	16	0x00010000	Reserved	
	17	0x00020000		
	18	0x00040000	Accelerometer	0 = Passed, 1 = Failed
	19	0x00080000	Accelerometer time-out	0 = Passed, 1 = Failed
N5	20	0x00100000	Reserved	
	21	0x00200000	Gyro initiated BIT	0 = Passed, 1 = Failed
	22	0x00400000	Gyro self-test	0 = Passed, 1 = Failed
	23	0x00800000	Gyro time-out	0 = Passed, 1 = Failed
N6	24	0x01000000	Analog-to-Digital (AD)	0 = Passed, 1 = Failed
	25	0x02000000	Test mode	0 = Passed, 1 = Failed
	26	0x04000000	Software	0 = Passed, 1 = Failed
	27	0x08000000	RAM/ROM	0 = Passed, 1 = Failed
N7	28	0x10000000	Reserved	
	29	0x20000000	Operational	0 = Passed, 1 = Failed
	30	0x40000000	Interface	0 = Passed, 1 = Failed
	31	0x80000000	Interface time-out	0 = Passed, 1 = Failed

Table 210: HG1700 IMU Status

Nibble	Bit	Mask	Description	Range Value
N0	0	0x00000001	Reserved	
	1	0x00000002	Reserved	
	2	0x00000004	Reserved	
	3	0x00000008	Reserved	

Nibble	Bit	Mask	Description	Range Value
N1	4	0x00000010	IMU Status	0 = Passed, 1 = Failed
	5	0x00000020	IMU Status	0 = Passed, 1 = Failed
	6	0x00000040	IMU Status	0 = Passed, 1 = Failed
	7	0x00000080	IMU Status	0 = Passed, 1 = Failed
N2	8	0x00000100	Reserved	
	9	0x00000200	Reserved	
	10	0x00000400	Reserved	
	11	0x00000800	Reserved	
N3	12	0x00001000	Reserved	
	13	0x00002000	Reserved	
	14	0x00004000	Reserved	
	15	0x00008000	Reserved	
N4	16	0x00010000	Reserved	
	17	0x00020000	Reserved	
	18	0x00040000	Reserved	
	19	0x00080000	Reserved	
N5	20	0x00100000	Reserved	
	21	0x00200000	Reserved	
	22	0x00400000	Reserved	
	23	0x00800000	Reserved	
N6	24	0x01000000	Reserved	
	25	0x02000000	Reserved	
	26	0x04000000	Reserved	
	27	0x08000000	IMU Status	0 = Passed, 1 = Failed
N7	28	0x10000000	IMU Status	0 = Passed, 1 = Failed
	29	0x20000000	IMU Status	0 = Passed, 1 = Failed
	30	0x40000000	IMU Status	0 = Passed, 1 = Failed
	31	0x80000000	IMU Status	0 = Passed, 1 = Failed

Table 211: LN200 IMU Status

Nibble	Bit	Mask	Description	Range Value
N0	0	0x00000001	IMU Status	0 = Passed, 1 = Failed
	1	0x00000002	IMU Status	0 = Passed, 1 = Failed
	2	0x00000004	IMU Status	0 = Passed, 1 = Failed
	3	0x00000008	IMU Status	0 = Passed, 1 = Failed
N1	4	0x00000010	IMU Status	0 = Passed, 1 = Failed
	5	0x00000020	IMU Status	0 = Passed, 1 = Failed
	6	0x00000040	IMU Status	0 = Passed, 1 = Failed
	7	0x00000080	IMU Status	0 = Passed, 1 = Failed
N2	8	0x00000100	IMU Status	0 = Passed, 1 = Failed
	9	0x00000200	IMU Status	0 = Passed, 1 = Failed
	10	0x00000400	IMU Status	0 = Passed, 1 = Failed
	11	0x00000800	IMU Status	0 = Passed, 1 = Failed
N3	12	0x00001000	IMU Status	0 = Passed, 1 = Failed
	13	0x00002000	IMU Status	0 = Passed, 1 = Failed
	14	0x00004000	IMU Status	0 = Passed, 1 = Failed
	15	0x00008000	Reserved	
N4	16	0x00010000	Reserved	
	17	0x00020000	Reserved	
	18	0x00040000	Reserved	
	19	0x00080000	Reserved	
N5	20	0x00100000	Reserved	
	21	0x00200000	Reserved	
	22	0x00400000	Reserved	
	23	0x00800000	Reserved	
N6	24	0x01000000	IMU Status	0 = Passed, 1 = Failed
	25	0x02000000	IMU Status	0 = Passed, 1 = Failed
	26	0x04000000	IMU Status	0 = Passed, 1 = Failed
	27	0x08000000	IMU Status	0 = Passed, 1 = Failed

Nibble	Bit	Mask	Description	Range Value
N7	28	0x10000000	IMU Status	0 = Passed, 1 = Failed
	29	0x20000000	Reserved	
	30	0x40000000	IMU Status	0 = Passed, 1 = Failed
	31	0x80000000	Reserved	

Table 212: ISA-100C IMU Status

Nibble	Bit	Mask	Description	Range Value
N0	0	0x00000001	Maintenance Indication	0 = Normal, 1 = System Maintenance Indicator
	1	0x00000002	Accelerometers Invalid	0 = Normal, 1 = Invalid
	2	0x00000004	Accelerometer X Warning	0 = Normal, 1 = Warning
	3	0x00000008	Accelerometer Y Warning	0 = Normal, 1 = Warning
N1	4	0x00000010	Accelerometer Z Warning	0 = Normal, 1 = Warning
	5	0x00000020	Accelerometer X NOGO	0 = Normal, 1 = NOGO
	6	0x00000040	Accelerometer Y NOGO	0 = Normal, 1 = NOGO
	7	0x00000080	Accelerometer Z NOGO	0 = Normal, 1 = NOGO
N2	8	0x00000100	Reset Occurred	0 = Normal, 1 = First Message after ISA-100C Reset
	9	0x00000200	Gyroscopes Invalid	0 = Normal, 1 = Invalid
	10	0x00000400	Gyroscope X Warning	0 = Normal, 1 = Warning
	11	0x00000800	Gyroscope Y Warning	0 = Normal, 1 = Warning
N3	12	0x00001000	Gyroscope Z Warning	0 = Normal, 1 = Warning
	13	0x00002000	Gyroscope X NOGO	0 = Normal, 1 = NOGO
	14	0x00004000	Gyroscope Y NOGO	0 = Normal, 1 = NOGO
	15	0x00008000	Gyroscope Z NOGO	0 = Normal, 1 = NOGO

Nibble	Bit	Mask	Description	Range Value
N4	16	0x00010000	IMU temperature reading as follows: Signed 2-byte value (SHORT) 1 LSB = 3.90625e ⁻³ Celsius Temperature Range +/- 128 Celsius	
	17	0x00020000		
	18	0x00040000		
	19	0x00080000		
N5	20	0x00100000		
	21	0x00200000		
	22	0x00400000		
	23	0x00800000		
N6	24	0x01000000		
	25	0x02000000		
	26	0x04000000		
	27	0x08000000		
N7	28	0x10000000		
	29	0x20000000		
	30	0x40000000		
	31	0x80000000		

Table 213: IMU-CPT IMU Status

Nibble	Bit	Mask	Description	Range Value
N0	0	0x00000001	Gyro X Status	1 = Valid, 0 = Invalid
	1	0x00000002	Gyro Y Status	1 = Valid, 0 = Invalid
	2	0x00000004	Gyro Z Status	1 = Valid, 0 = Invalid
	3	0x00000008	Unused	Set to 0
N1	4	0x00000010	Accelerometer X Status	1 = Valid, 0 = Invalid
	5	0x00000020	Accelerometer Y Status	1 = Valid, 0 = Invalid
	6	0x00000040	Accelerometer Z Status	1 = Valid, 0 = Invalid
	7	0x00000080	Unused	Set to 0

Nibble	Bit	Mask	Description	Range Value		
N2	8	0x00000100	IMU Data Sequence Counter read in a Ushort. Note: Increments for each message and resets to 0 after 127.			
	9	0x00000200				
	10	0x00000400				
	11	0x00000800				
N3	12	0x00001000				
	13	0x00002000				
	14	0x00004000				
	15	0x00008000				
N4	16	0x00010000			Unused	
	17	0x00020000				
	18	0x00040000				
	19	0x00080000				
N5	20	0x00100000				
	21	0x00200000				
	22	0x00400000				
	23	0x00800000				
N6	24	0x01000000				
	25	0x02000000				
	26	0x04000000				
	27	0x08000000				
N7	28	0x10000000				
	29	0x20000000				
	30	0x40000000				
	31	0x80000000				

Table 214: IMU-KVH1750 IMU Status

Nibble	Bit	Mask	Description	Range Value
N0	0	0x00000001	Gyro X Status	1 = Valid, 0 = Invalid
	1	0x00000002	Gyro Y Status	1 = Valid, 0 = Invalid
	2	0x00000004	Gyro Z Status	1 = Valid, 0 = Invalid
	3	0x00000008	Unused	Set to 0
N1	4	0x00000010	Accelerometer X Status	1 = Valid, 0 = Invalid
	5	0x00000020	Accelerometer Y Status	1 = Valid, 0 = Invalid
	6	0x00000040	Accelerometer Z Status	1 = Valid, 0 = Invalid
	7	0x00000080	Unused	Set to 0
N2	8	0x00000100	IMU Data Sequence Counter read in a Ushort. Note: Increments for each message and resets to 0 after 127.	
	9	0x00000200		
	10	0x00000400		
	11	0x00000800		
N3	12	0x00001000		
	13	0x00002000		
	14	0x00004000		
	15	0x00008000		

Nibble	Bit	Mask	Description	Range Value
N4	16	0x00010000	IMU temperature reading as follows: Signed 2-byte value (SHORT) Rounded to the nearest degree	
	17	0x00020000		
	18	0x00040000		
	19	0x00080000		
N5	20	0x00100000	Example: <RAWIMU COM1 0 75.0 FINESTEERING 1813 514207.000 00000020 fa9a 45836 1813 514207.0000000000 00260077 32164 -47 -305 1 -10 0	
	21	0x00200000		
	22	0x00400000		
	23	0x00800000		
N6	24	0x01000000	IMU status = 00260077 Temperatures bytes = 0026 Decimal value = 38 degrees C	
	25	0x02000000		
	26	0x04000000		
	27	0x08000000		
N7	28	0x10000000		
	29	0x20000000		
	30	0x40000000		
	31	0x80000000		

Table 215: HG1900 and HG1930 IMU Status

Nibble	Bit	Mask	Description	Range Value
N0	0	0x00000001	Reserved	
	1	0x00000002		
	2	0x00000004		
	3	0x00000008		
N1	4	0x00000010	IMU Status	0 = Passed, 1 = Failed
	5	0x00000020	IMU Status	0 = Passed, 1 = Failed
	6	0x00000040	IMU Status	0 = Passed, 1 = Failed
	7	0x00000080	IMU Status	0 = Passed, 1 = Failed

Nibble	Bit	Mask	Description	Range Value
N2	8	0x00000100	Reserved	
	9	0x00000200		
	10	0x00000400		
	11	0x00000800		
N3	12	0x00001000	Reserved	
	13	0x00002000		
	14	0x00004000		
	15	0x00008000		
N4	16	0x00010000	Reserved	
	17	0x00020000		
	18	0x00040000		
	19	0x00080000		
N5	20	0x00100000	Reserved	
	21	0x00200000		
	22	0x00400000		
	23	0x00800000		
N6	24	0x01000000	IMU Status	0 = Passed, 1 = Failed
	25	0x02000000	Reserved	
	26	0x04000000	IMU Status	0 = Passed, 1 = Failed
	27	0x08000000	IMU Status	0 = Passed, 1 = Failed
N7	28	0x10000000	IMU Status	0 = Passed, 1 = Failed
	29	0x20000000	IMU Status	0 = Passed, 1 = Failed
	30	0x40000000	IMU Status	0 = Passed, 1 = Failed
	31	0x80000000	Reserved	

Table 216: HG4930 IMU Status

Nibble	Bit	Mask	Description	Range Value
N0	0	0x00000001	IMU Status	0 = Passed, 1 = Failed
	1	0x00000002	Reserved	
	2	0x00000004		
	3	0x00000008	Gyro Status	0 = Passed, 1 = Failed
N1	4	0x00000010	Accelerometer Status	0 = Passed, 1 = Failed
	5	0x00000020	Reserved	
	6	0x00000040	IMU Status	0 = Passed, 1 = Failed
	7	0x00000080	Reserved	
N2	8	0x00000100	Reserved	
	9	0x00000200		
	10	0x00000400		
	11	0x00000800		
N3	12	0x00001000	Reserved	
	13	0x00002000		
	14	0x00004000		
	15	0x00008000		
N4	16	0x00010000	Reserved	
	17	0x00020000		
	18	0x00040000		
	19	0x00080000		
N5	20	0x00100000	Reserved	
	21	0x00200000		
	22	0x00400000		
	23	0x00800000		
N6	24	0x01000000	Reserved	
	25	0x02000000		
	26	0x04000000		
	27	0x08000000		

Nibble	Bit	Mask	Description	Range Value
N7	28	0x10000000	Reserved	
	29	0x20000000		
	30	0x40000000		
	31	0x80000000		

Table 217: ADIS16488 and IMU-IGM-A1 IMU Status

Nibble	Bit	Mask	Description	Range Value
N0	0	0x00000001	Alarm Status Flag	
	1	0x00000002	Reserved	
	2	0x00000004		
	3	0x00000008	SPI Communication Error	0 = Passed, 1 = Failed
N1	4	0x00000010	Sensor Over-Range	0 = Passed, 1 = One of more sensors over- ranged
	5	0x00000020	Initial Self Test Failure	0 = Passed, 1 = Failed
	6	0x00000040	Flash Memory Failure	0 = Passed, 1 = Failed
	7	0x00000080	Processing Overrun	0 = Passed, 1 = Failed
N2	8	0x00000100	Self Test Failure – X-axis gyro	0 = Passed, 1 = Failed
	9	0x00000200	Self Test Failure – Y-axis gyro	0 = Passed, 1 = Failed
	10	0x00000400	Self Test Failure – Z-axis gyro	0 = Passed, 1 = Failed
	11	0x00000800	Self Test Failure – X-axis accelerometer	0 = Passed, 1 = Failed
N3	12	0x00001000	Self Test Failure – Y-axis accelerometer	0 = Passed, 1 = Failed
	13	0x00002000	Self Test Failure – Z-axis	0 = Passed, 1 = Failed
	14	0x00004000	Reserved	
	15	0x00008000		

Nibble	Bit	Mask	Description	Range Value
N4	16	0x00010000	IMU temperature reading as follows: Signed 2-byte value (SHORT) 25°C = 0x0000 1 LSB = 0.00565°C	
	17	0x00020000		
	18	0x00040000		
	19	0x00080000		
N5	20	0x00100000		
	21	0x00200000		
	22	0x00400000		
	23	0x00800000		
N6	24	0x01000000		
	25	0x02000000		
	26	0x04000000		
	27	0x08000000		
N7	28	0x10000000		
	29	0x20000000		
	30	0x40000000		
	31	0x80000000		

Table 218: STIM300 and IMU-IGM-S1 IMU Status

Nibble	Bit	Mask	Description	Range Value
N0	0	0x00000001	Gyro status	0 = OK, 1 = X-channel
	1	0x00000002		0 = OK, 1 = Y-channel
	2	0x00000004		0 = OK, 1 = Z-channel
	3	0x00000008		0 = OK, 1 = Error in measurement channel (Bits 0-2 flag the error channels)
N1	4	0x00000010		0 = OK, 1 = Overload (Bits 0-2 flag the error channels)
	5	0x00000020		0 = OK, 1 = Outside operating conditions
	6	0x00000040		0 = OK, 1 = Startup
	7	0x00000080		0 = OK, 1 = System integrity error

Nibble	Bit	Mask	Description	Range Value
N2	8	0x00000100	Accelerometer Status	0 = OK, 1 = X-channel
	9	0x00000200		0 = OK, 1 = Y-channel
	10	0x00000400		0 = OK, 1 = Z-channel
	11	0x00000800		0 = OK, 1 = Error in measurement channel (Bits 0-2 flag the error channels)
N3	12	0x00001000		0 = OK, 1 = Overload (Bits 0-2 flag the error channels)
	13	0x00002000		0 = OK, 1 = Outside operating conditions
	14	0x00004000		0 = OK, 1 = Startup
	15	0x00008000		0 = OK, 1 = System integrity error
N4	16	0x00010000	Temperature of the X gyro sensor 0°C = 0x0000 1 LSB = 2 ⁻⁸ °C	
	17	0x00020000		
	18	0x00040000		
	19	0x00080000		
N5	20	0x00100000		
	21	0x00200000		
	22	0x00400000		
	23	0x00800000		
N6	24	0x01000000		
	25	0x02000000		
	26	0x04000000		
	27	0x08000000		
N7	28	0x10000000		
	29	0x20000000		
	30	0x40000000		
	31	0x80000000		

Table 219: μ IMU IMU Status

Nibble	Bit	Mask	Description	Range Value
N0	0	0x00000001	Reset Acknowledged	0 = Normal, 1 = Reset
	1	0x00000002	Gyros Not Initialized	0 = Normal, 1 = Not Initialized
	2	0x00000004	Gyro X Warning	0 = Normal, 1 = Warning
	3	0x00000008	Gyro Y Warning	0 = Normal, 1 = Warning
N1	4	0x00000010	Gyro Z Warning	0 = Normal, 1 = Warning
	5	0x00000020	Gyro X NOGO	0 = Normal, 1 = NOGO
	6	0x00000040	Gyro Y NOGO	0 = Normal, 1 = NOGO
	7	0x00000080	Gyro Z NOGO	0 = Normal, 1 = NOGO
N2	8	0x00000100	Reserved	
	9	0x00000200	Accels Not Initialized	0 = Normal, 1 = Not Initialized
	10	0x00000400	Accel X Warning	0 = Normal, 1 = Warning
	11	0x00000800	Accel Y Warning	0 = Normal, 1 = Warning
N3	12	0x00001000	Accel Z Warning	0 = Normal, 1 = Warning
	13	0x00002000	Accel X NOGO	0 = Normal, 1 = NOGO
	14	0x00004000	Accel Y NOGO	0 = Normal, 1 = NOGO
	15	0x00008000	Accel Z NOGO	0 = Normal, 1 = NOGO

Nibble	Bit	Mask	Description	Range Value
N4	16	0x00010000	IMU temperature reading as follows: Signed 2-byte value (SHORT) 1 LSB = 3.90625e ⁻³ °C Temperature Range +/- 128 °C	
	17	0x00020000		
	18	0x00040000		
	19	0x00080000		
N5	20	0x00100000		
	21	0x00200000		
	22	0x00400000		
	23	0x00800000		
N6	24	0x01000000		
	25	0x02000000		
	26	0x04000000		
	27	0x08000000		
N7	28	0x10000000		
	29	0x20000000		
	30	0x40000000		
	31	0x80000000		

Table 220: G320N and G370N IMU Status

Nibble	Bit	Mask	Description	Range Value
N0	0	0x00000001	Error All	0 = Normal, 1 = Sensor Failure
	1	0x00000002	Reserved	
	2	0x00000004		
	3	0x00000008		
N1	4	0x00000010		
	5	0x00000020		
	6	0x00000040		
	7	0x00000080		

Nibble	Bit	Mask	Description	Range Value
N2	8	0x00000100		
	9	0x00000200	Accel Z - New Data	New Data = 1, No Data = 0
	10	0x00000400	Accel Y - New Data	New Data = 1, No Data = 0
	11	0x00000800	Accel X - New Data	New Data = 1, No Data = 0
N3	12	0x00001000	Gyro Z - New Data	New Data = 1, No Data = 0
	13	0x00002000	Gyro Y - New Data	New Data = 1, No Data = 0
	14	0x00004000	Gyro X - New Data	New Data = 1, No Data = 0
	15	0x00008000	Temperature - New Data	New Data = 1, No Data = 0
N4	16	0x00010000	IMU Temperature reading as follows: $\text{Temperature} = [(-0.0037918 * (A - 2634)) + 25]$ Celsius A: Temperature Sensor output data (decimal)	
	17	0x00020000		
	18	0x00040000		
	19	0x00080000		
N5	20	0x00100000		
	21	0x00200000		
	22	0x00400000		
	23	0x00800000		
N6	24	0x01000000		
	25	0x02000000		
	26	0x04000000		
	27	0x08000000		
N7	28	0x10000000		
	29	0x20000000		
	30	0x40000000		
	31	0x80000000		



The values in *Table 220: G320N and G370N IMU Status* on the previous page also apply to the PwrPak7-E1, PwrPak7D-E1, PwrPak7-E2, PwrPak7D-E2 and SMART7-S.

5.34 RAWIMUS

Short Raw IMU Data

Platform: OEM719, OEM729, OEM7500, OEM7600, OEM7700, OEM7720, PwrPak7, SPAN CPT7, SMART7-S, SMART7-SI

This log is the short header version of the **RAWIMU** log (see page 910).



The change in velocity (acceleration) and angle (rotation rate) scale factors for each IMU type can be found in *Table 221: Raw IMU Scale Factors* on page 931. Multiply the appropriate scale factor by the count value for the velocity (field 5-7) and angle (field 8-10) increments.



To obtain acceleration in m/s/s or rotation rate in rad/s, multiply the velocity/rotation increments by the output rate of the IMU:

- 100 Hz for HG1700, HG1900, HG1930 and HG4930
- 125 Hz for STIM300, G320N, PwrPak7-E1, PwrPak7D-E1 and SMART7-S
- 200 Hz for ISA-100C, iMAR-FSAS, LN200, KVH1750, ADIS16488, G370N, PwrPak7-E2 and PwrPak7D-E2

The units of acceleration and rotation rate will depend on the IMU Scale Factors.



This log is output in the IMU Body frame.

Message ID: 325

Log Type: Asynch

Recommended Input:

```
log rawimusa onnew
```

ASCII Example:

```
%RAWIMUSA,1105,425384.180;1105,425384.156166800,111607,43088060,430312,-3033352,-132863,186983,823*5aa97065
```

Field	Field Type	Description	Format	Binary Bytes	Binary Offset
1	RAWIMUS Header	Log header. See <i>Messages</i> on page 27 for more information.	-	H	0
2	Week	GNSS Week	Ulong	4	H
3	Seconds into Week	Seconds from week start	Double	8	H+4

Field	Field Type	Description	Format	Binary Bytes	Binary Offset
4	IMU Status	<p>The status of the IMU. This field is given in a fixed length (n) array of bytes in binary but in ASCII or Abbreviated ASCII is converted into 2 character hexadecimal pairs.</p> <p>For the raw IMU status, see one of the following tables:</p> <ul style="list-style-type: none"> • <i>Table 209: iIMU-FSAS IMU Status</i> on page 912 • <i>Table 210: HG1700 IMU Status</i> on page 913 • <i>Table 211: LN200 IMU Status</i> on page 915 • <i>Table 212: ISA-100C IMU Status</i> on page 916 • <i>Table 213: IMU-CPT IMU Status</i> on page 917 • <i>Table 214: IMU-KVH1750 IMU Status</i> on page 919 • <i>Table 215: HG1900 and HG1930 IMU Status</i> on page 920 • <i>Table 216: HG4930 IMU Status</i> on page 922 • <i>Table 217: ADIS16488 and IMU-IGM-A1 IMU Status</i> on page 923 • <i>Table 218: STIM300 and IMU-IGM-S1 IMU Status</i> on page 924 • <i>Table 219: μIMU IMU Status</i> on page 926 • <i>Table 220: G320N and G370N IMU Status</i> on page 927 <p>Also refer to Interface Control Documentation as provided by Honeywell or Northrop Grumman.</p>	Hex Ulong	4	H+12
5	Z Accel Output	Change in velocity count along z axis	Long	4	H+16
6	- (Y Accel Output)	<p>- (Change in velocity count along y axis)</p> <p>A negative value implies the output is along the positive y-axis marked on the IMU. A positive value implies the change is in the direction opposite to that of the y-axis marked on the IMU.</p>	Long	4	H+20
7	X Accel Output	Change in velocity count along x axis	Long	4	H+24

Field	Field Type	Description	Format	Binary Bytes	Binary Offset
8	Z Gyro Output	Change in angle count around z axis Right-handed	Long	4	H+28
9	- (Y Gyro Output)	- (Change in angle count around y axis) Right-handed A negative value implies the output is along the positive y-axis marked on the IMU. A positive value implies the change is in the direction opposite to that of the y-axis marked on the IMU.	Long	4	H+32
10	X Gyro Output	Change in angle count around x axis Right-handed	Long	4	H+36
11	xxxx	32-bit CRC (ASCII, Binary and Short Binary only)	Hex	4	H+40
12	[CR][LF]	Sentence terminator (ASCII only)	-	-	-

Table 221: Raw IMU Scale Factors

	Gyroscope Scale Factor	Acceleration Scale Factor
HG1700-AG58 HG1900-CA29/CA50 HG1930-AA99/CA50	2.0^{-33} rad/LSB	2.0^{-27} ft/s/LSB
HG1700-AG62	2.0^{-33} rad/LSB	2.0^{-26} ft/s/LSB
HG4930-AN01 SPAN CPT7	2.0^{-33} rad/LSB	2.0^{-29} m/s/LSB
IMU-CPT IMU-KVH1750	$0.1 / (3600.0 \times 256.0)$ rad/LSB	$0.05 / 2^{15}$ m/s/LSB
IMU-FSAS	0.1×2^{-8} arcsec/LSB	0.05×2^{-15} m/s/LSB
LN-200	2^{-19} rad/LSB	2^{-14} m/s/LSB
ISA-100C μIMU	1.0×10^{-9} rad/LSB	2.0×10^{-8} m/s/LSB
ADIS16488 IMU-IGM-A1	$720 / 2^{31}$ deg/LSB	$200 / 2^{31}$ m/s/LSB
STIM300 IMU-IGM-S1	2^{-21} deg/LSB	2^{-22} m/s/LSB

	Gyroscope Scale Factor	Acceleration Scale Factor
G320N PwrPak7-E1 PwrPak7D-E1 SMART7-S	$(0.008/65536)/125 \text{ deg/LSB}$	$(0.200/65536)/125 \text{ mG/s/LSB}^1$
G370N PwrPak7-E2 PwrPak7D-E2	$(0.0151515/65536)/200 \text{ deg/LSB}$	$(0.400/65536)/200 \text{ mG/s/LSB}^1$



LSB = Least Significant Bit

¹1 G = 9.80665 m/s/s

5.35 RAWIMUSX

IMU Data Extended

Platform: OEM719, OEM729, OEM7500, OEM7600, OEM7700, OEM7720, PwrPak7, SPAN CPT7, SMART7-S, SMART7-SI

This is the short header version of the extended RAWIMUX log intended for use with post-processing. The extended version includes IMU information that is used by the NovAtel Inertial Explorer post-processing software.



The change in velocity (acceleration) and angle (rotation rate) scale factors for each IMU type can be found in *Table 221: Raw IMU Scale Factors* on page 931. Multiply the appropriate scale factor by the count value for the velocity (field 7-9) and angle (field 10-12) increments.



To obtain acceleration in m/s/s or rotation rate in rad/s, multiply the velocity/rotation increments by the output rate of the IMU:

- 100 Hz for HG1700, HG1900, HG1930 and HG4930
- 125 Hz for STIM300, G320N, PwrPak7-E1, PwrPak7D-E1 and SMART7-S
- 200 Hz for ISA-100C, iMAR-FSAS, LN200, KVH1750, ADIS16488, G370N, PwrPak7-E2 and PwrPak7D-E2

The units of acceleration and rotation rate will depend on the IMU Scale Factors.



This log is output in the IMU Body frame.

Message ID: 1462

Log Type: Asynch

Recommended Input:

```
log rawimusxb onnew
```

ASCII example:

```
%RAWIMUSXA,1692,484620.664;00,11,1692,484620.664389000,00801503,43110635,-817242,-202184,-215194,-41188,-9895*a5db8c7b
```

Field	Field Type	Description	Format	Binary Bytes	Binary Offset
1	RAWIMUSX Header	Log header. See <i>Messages</i> on page 27 for more information. (short)	-	H	0

Field	Field Type	Description	Format	Binary Bytes	Binary Offset
2	IMU Info	IMU Info Bits Bit 0: If set, an IMU error was detected. Check the IMU Status field for details. Bit 1: If set, the IMU data is encrypted and should not be used. Bits 2 to 7: Reserved	Hex Uchar	1	H
3	IMU Type	IMU Type identifier. See <i>Table 191: IMU Type</i> on page 813.	Uchar	1	H+1
4	GNSS Week	GNSS Week	Ushort	2	H+2
5	GNSS Week Seconds	Seconds from week start	Double	8	H+4

Field	Field Type	Description	Format	Binary Bytes	Binary Offset
6	IMU Status	<p>The status of the IMU. This field is given in a fixed length (n) array of bytes in binary but in ASCII or Abbreviated ASCII is converted into 2 character hexadecimal pairs.</p> <p>For the raw IMU status, see one of the following tables:</p> <ul style="list-style-type: none"> • <i>Table 209: iIMU-FSAS IMU Status</i> on page 912 • <i>Table 210: HG1700 IMU Status</i> on page 913 • <i>Table 211: LN200 IMU Status</i> on page 915 • <i>Table 212: ISA-100C IMU Status</i> on page 916 • <i>Table 213: IMU-CPT IMU Status</i> on page 917 • <i>Table 214: IMU-KVH1750 IMU Status</i> on page 919 • <i>Table 215: HG1900 and HG1930 IMU Status</i> on page 920 • <i>Table 216: HG4930 IMU Status</i> on page 922 • <i>Table 217: ADIS16488 and IMU-IGM-A1 IMU Status</i> on page 923 • <i>Table 218: STIM300 and IMU-IGM-S1 IMU Status</i> on page 924 • <i>Table 219: μIMU IMU Status</i> on page 926 • <i>Table 220: G320N and G370N IMU Status</i> on page 927 <p>Also refer to Interface Control Documentation as provided by Honeywell or Northrop Grumman.</p>	Hex Ulong	4	H+12
7	Z Accel	Change in velocity count along Z-axis.	Long	4	H+16
8	-(Y Accel)	<p>- (Change in velocity count along y-axis.)</p> <p>A negative value implies the output is along the positive y-axis marked on the IMU. A positive value implies the change is in the direction opposite to that of the y-axis marked on the IMU.</p>	Long	4	H+20

Field	Field Type	Description	Format	Binary Bytes	Binary Offset
9	X Accel	Change in velocity count along x axis.	Long	4	H+24
10	Z Gyro	Change in angle count around z axis. Right-handed	Long	4	H+28
11	-(Y Gyro)	- (Change in angle count around y axis.) Right-handed A negative value implies the output is along the positive y-axis marked on the IMU. A positive value implies the change is in the direction opposite to that of the y-axis marked on the IMU.	Long	4	H+32
12	X Gyro	Change in angle count around x axis. Right-handed	Long	4	H+36
13	XXXX	32-bit CRC (ASCII, Binary, and Short Binary only)	Hex	4	H+40
14	[CR][LF]	Sentence terminator (ASCII only)	-	-	-

5.36 RAWIMUX

IMU Data Extended

Platform: OEM719, OEM729, OEM7500, OEM7600, OEM7700, OEM7720, PwrPak7, SPAN CPT7, SMART7-S, SMART7-SI

This log is an extended version of the RAWIMU log intended for use with post-processing. The extended version includes IMU information that is used by the NovAtel Inertial Explorer post-processing software.



The change in velocity (acceleration) and angle (rotation rate) scale factors for each IMU type can be found in *Table 221: Raw IMU Scale Factors* on page 931. Multiply the appropriate scale factor by the count value for the velocity (field 7-9) and angle (field 10-12) increments.



To obtain acceleration in m/s/s or rotation rate in rad/s, multiply the velocity/rotation increments by the output rate of the IMU:

- 100 Hz for HG1700, HG1900, HG1930 and HG4930
- 125 Hz for STIM300, G320N, PwrPak7-E1, PwrPak7D-E1 and SMART7-S
- 200 Hz for ISA-100C, iMAR-FSAS, LN200, KVH1750, ADIS16488, G370N, PwrPak7-E2 and PwrPak7D-E2

The units of acceleration and rotation rate will depend on the IMU Scale Factors.



This log is output in the IMU Body frame.

Message ID: 1461

Log Type: Asynch

Recommended Input:

```
log rawimuxb onnew
```

ASCII example:

```
#RAWIMUXA,COM1,0,81.5,FINESTEERING,1691,410338.819,024c0020,3fd1,43495;00,5,1691,410338.818721000,00170705,-113836,-464281,43146813,89,11346,181*01cd06bf
```

Field	Field Type	Description	Format	Binary Bytes	Binary Offset
1	RAWIMUX Header	Log header. See <i>Messages</i> on page 27 for more information.	-	H	0

Field	Field Type	Description	Format	Binary Bytes	Binary Offset
2	IMU Info	<p>IMU Info Bits</p> <p>Bit 0: If set, an IMU error was detected. Check the IMU Status field for details.</p> <p>Bit 1: If set, the IMU data is encrypted and should not be used.</p> <p>Bits 2 to 7: Reserved</p>	Hex Uchar	1	H
3	IMU Type	<p>IMU Type identifier.</p> <p>See <i>Table 191: IMU Type</i> on page 813.</p>	Uchar	1	H+1
4	GNSS Week	GNSS Week	Ushort	2	H+2
5	GNSS Week Seconds	Seconds from week start	Double	8	H+4

Field	Field Type	Description	Format	Binary Bytes	Binary Offset
6	IMU Status	<p>The status of the IMU. This field is given in a fixed length (n) array of bytes in binary but in ASCII or Abbreviated ASCII is converted into 2 character hexadecimal pairs.</p> <p>For the raw IMU status, see one of the following tables:</p> <ul style="list-style-type: none"> • <i>Table 209: iIMU-FSAS IMU Status</i> on page 912 • <i>Table 210: HG1700 IMU Status</i> on page 913 • <i>Table 211: LN200 IMU Status</i> on page 915 • <i>Table 212: ISA-100C IMU Status</i> on page 916 • <i>Table 213: IMU-CPT IMU Status</i> on page 917 • <i>Table 214: IMU-KVH1750 IMU Status</i> on page 919 • <i>Table 215: HG1900 and HG1930 IMU Status</i> on page 920 • <i>Table 216: HG4930 IMU Status</i> on page 922 • <i>Table 217: ADIS16488 and IMU-IGM-A1 IMU Status</i> on page 923 • <i>Table 218: STIM300 and IMU-IGM-S1 IMU Status</i> on page 924 • <i>Table 219: μIMU IMU Status</i> on page 926 • <i>Table 220: G320N and G370N IMU Status</i> on page 927 <p>Also refer to Interface Control Documentation as provided by Honeywell or Northrop Grumman.</p>	Hex Ulong	4	H+12
7	Z Accel	Change in velocity count along Z-axis.	Long	4	H+16
8	-(Y Accel)	<p>- (Change in velocity count along y-axis.)</p> <p>A negative value implies the output is along the positive y-axis marked on the IMU. A positive value implies the change is in the direction opposite to that of the y-axis marked on the IMU.</p>	Long	4	H+20
9	X Accel	Change in velocity count along x axis.	Long	4	H+24

Field	Field Type	Description	Format	Binary Bytes	Binary Offset
10	Z Gyro	Change in angle count around z axis. Right-handed	Long	4	H+28
11	-(Y Gyro)	- (Change in angle count around y axis.) Right-handed A negative value implies the output is along the positive y-axis marked on the IMU. A positive value implies the change is in the direction opposite to that of the y-axis marked on the IMU.	Long	4	H+32
12	X Gyro	Change in angle count around x axis. Right-handed	Long	4	H+36
13	XXXX	32-bit CRC (ASCII, Binary, and Short Binary only)	Hex	4	H+40
14	[CR][LF]	Sentence terminator (ASCII only)	-	-	-

5.37 RELINSPVA

Relative INSPVA log

Platform: OEM719, OEM729, OEM7500, OEM7600, OEM7700, OEM7720, PwrPak7, SPAN CPT7, SMART7-S, SMART7-SI

This log provides the relative offset between the Master and Rover Inertial Solutions. The output solution provides the offset of where the local station is with respect to the other station.



This log should only be requested with the ONCHANGED or ONTIME trigger.



To use the **RELINSPVA** log, the receiver requires a model with the INS Mode set to **R**.

Message ID: 1446

Log Type: Asynch

Recommended Input:

LOG RELINSPVAA ONNEW

ASCII example:

```
#RELINSPVAA,COM1,0,61.0,FINESTEERING,1805,245074.000,02000000,2338,45757;BODY,
9.285958662,-0.755483058,0.079229338,0.001739020,-0.000126304,0.001525848,
0.321033045,0.669367786,4.466250181,0.000000000,"b81V",INS_ALIGNMENT_COMPLETE,
"B20C",INS_ALIGNMENT_COMPLETE,NARROW_INT,00000000*a114ce3c
```

Field	Field Type	Description	Format	Binary Bytes	Binary Offset
1	RELINSPVA Header	Log header. See <i>Messages</i> on page 27 for more information.	-	H	0
2	Output Frame	The current output frame (IMU body, ECEF or local level frame). The output frame is specified using the SETRELINSOUTPUTFRAME command (see page 842)	Enum	4	H
3	DeltaPosX	Difference in the position between the two receivers (m). The position difference is relative to the output frame: BODY = along the X-axis ECEF = along the X-axis Local level = Northing	Double	8	H+4

Field	Field Type	Description	Format	Binary Bytes	Binary Offset
4	DeltaPosY	Difference in the position between the two receivers (m). The position difference is relative to the output frame: BODY = along the Y-axis ECEF = along the Y-axis Local level = Easting	Double	8	H+12
5	DeltaPosZ	Difference in the position between the two receivers (m). The position difference is relative to the output frame: BODY = along the Z-axis ECEF = along the Z-axis Local level = Up	Double	8	H+20
6	DeltaVelX	Difference in velocity between the two receivers (m/s). The position difference is relative to the output frame: BODY = along the X-axis ECEF = along the X-axis Local level = Northing	Double	8	H+28
7	DeltaVelY	Difference in velocity between two receivers (m/s). The position difference is relative to the output frame: BODY = along the Y-axis ECEF = along the Y-axis Local level = Easting	Double	8	H+36
8	DeltaVelZ	Difference in velocity between the two receivers (m/s). The position difference is relative to the output frame: BODY = along the Z-axis ECEF = along the Z-axis Local level = Up	Double	8	H+44
9	DeltaRoll	Difference in roll between the two receivers (degrees).	Double	8	H+52
10	DeltaPitch	Difference in pitch between the two receivers (degrees).	Double	8	H+60

Field	Field Type	Description	Format	Binary Bytes	Binary Offset
11	DeltaHeading	Difference in heading between the two receivers (degrees).	Double	8	H+68
12	Diff Age	Differential age in seconds.	Float	4	H+76
13	Rover ID	Rover receiver ID string.	Char[4]	4	H+80
14	Rover INSStatus	INS status of the rover receiver. See <i>Table 198: Inertial Solution Status</i> on page 863	Enum	4	H+84
15	Master ID	Master receiver ID string.	Char[4]	4	H+88
16	Master INSStatus	INS status of the master receiver. See <i>Table 198: Inertial Solution Status</i> on page 863	Enum	4	H+92
17	RTK Status	Status of the current RTK vector between master and rover. See <i>Table 66: Position or Velocity Type</i> on page 375	Enum	4	H+96
18	ExtStatus	Extended solution status. See <i>Table 199: Extended Solution Status</i> on page 868	Hex	4	H+100
20	xxxx	32-bit CRC (ASCII and Binary only)	Hex	4	H+104
21	[CR][LF]	Sentence terminator (ASCII only)	-	-	-

5.38 SYNCRELINSPVA

Synchronous Relative INSPVA log

Platform: OEM719, OEM729, OEM7500, OEM7600, OEM7700, OEM7720, PwrPak7, SPAN CPT7, SMART7-S, SMART7-SI

This log provides the relative offset between the master and rover inertial solutions. The output solution provides the offset of where the local station is with respect to the other station.



To use the **SYNCRELINSPVA** log, the receiver requires a model with the INS Mode set to **R**.



This log is designed to provide synchronous, relative Position, Velocity and Attitude information, propagating the information between matched corrections between the master and remote solutions. It is highly recommended that the highest rate of corrections be used at all times for the most precise and robust performance.

Message ID: 1743

Log Type: Synch

Recommended Input:

```
LOG SYNCRELINSPVAA ONTIME 1
```

ASCII example:

```
#SYNCRELINSPVAA,COM1,0,72.5,FINESTEERING,1805,247243.000,02000000,e9c7,13005;
BODY,8.141080733,-2.779177478,2.045421773,-0.001464009,-0.001038329,
0.002323548,0.409467974,0.715633909,-6.204731538,0.000000000,"B81V",INS_
ALIGNMENT_COMPLETE,"B20C",INS_ALIGNMENT_COMPLETE,INS_PSRSP,00000000*e270f5c8
```

Field	Field Type	Description	Format	Binary Bytes	Binary Offset
1	SYNCRELINSPVA Header	Log header. See <i>Messages</i> on page 27 for more information.	-	H	0
2	Output Frame	The current output frame (IMU body, ECEF or local level frame). The output frame is specified using the SETRELINSOUTPUTFRAME command (see page 842)	Enum	4	H

Field	Field Type	Description	Format	Binary Bytes	Binary Offset
3	DeltaPosX	Difference in the position between the two receivers (m). The position difference is relative to the output frame: BODY = along the X-axis ECEF = along the X-axis Local level = Northing	Double	8	H+4
4	DeltaPosY	Difference in the position between the two receivers (m). The position difference is relative to the output frame: BODY = along the Y-axis ECEF = along the Y-axis Local level = Easting	Double	8	H+12
5	DeltaPosZ	Difference in the position between the two receivers (m). The position difference is relative to the output frame: BODY = along the Z-axis ECEF = along the Z-axis Local level = Up	Double	8	H+20
6	DeltaVelX	Difference in velocity between the two receivers (m/s). The position difference is relative to the output frame: BODY = along the X-axis ECEF = along the X-axis Local level = Northing	Double	8	H+28
7	DeltaVelY	Difference in velocity between two receivers (m/s). The position difference is relative to the output frame: BODY = along the Y-axis ECEF = along the Y-axis Local level = Easting	Double	8	H+36

Field	Field Type	Description	Format	Binary Bytes	Binary Offset
8	DeltaVelZ	Difference in velocity between the two receivers (m/s). The position difference is relative to the output frame: BODY = along the Z-axis ECEF = along the Z-axis Local level = Up	Double	8	H+44
9	DeltaRoll	Difference in roll between the two receivers (degrees).	Double	8	H+52
10	DeltaPitch	Difference in pitch between the two receivers (degrees).	Double	8	H+60
11	DeltaHeading	Difference in heading between the two receivers (degrees).	Double	8	H+68
12	Diff Age	Differential age in seconds.	Float	4	H+76
13	Rover ID	Rover receiver ID string.	Char[4]	4	H+80
14	Rover INSStatus	INS status of the rover receiver. See <i>Table 198: Inertial Solution Status</i> on page 863	Enum	4	H+84
15	Master ID	Master receiver ID string.	Char[4]	4	H+88
16	Master INSStatus	INS status of the master receiver. See <i>Table 198: Inertial Solution Status</i> on page 863	Enum	4	H+92
17	RTK Status	Status of the current RTK vector between master and rover. See <i>Table 66: Position or Velocity Type</i> on page 375	Enum	4	H+96
18	ExtStatus	Extended solution status. See <i>Table 199: Extended Solution Status</i> on page 868	Hex	4	H+100
20	xxxx	32-bit CRC (ASCII and Binary only)	Hex	4	H+104
21	[CR][LF]	Sentence terminator (ASCII only)	-	-	-

5.39 TSS1

TSS1 Protocol for Heave, Roll and Pitch

Platform: OEM719, OEM729, OEM7500, OEM7600, OEM7700, OEM7720, PwrPak7, SPAN CPT7, SMART7-S, SMART7-SI

This log provides heave, roll and pitch information in TSS1 protocol.



This message is in a different format than any other log output by the SPAN system.

Message ID: 1456

Log Type: Synch

Recommended Input:

```
log tss1a ontime 1
```

Message Format:

```
:XXAAAASMHQHQRSMPPPP<CR><LF>
```

ASCII Example:

```
:00FFCA -0003F-0325 0319
```

Field	Field Type	Description	Symbol	Example
1	TSS1 Header	Log header. See <i>Messages</i> on page 27 for more information.	:	:
2	Horizontal Acceleration	Horizontal acceleration from 0 to 9.81m/s ² . Shown as a one byte unsigned hex number where the least significant bit = 3.83 cm/s ² .	XX	00
3	Vertical Acceleration	Vertical acceleration from -20.48 to +20.48 m/s ² . Shown as a two byte hex number where the least significant bit = 0.0625 cm/s ² .	AAAA	FFCA
4	Space Character	A space delimiter.	S	
5	Heave Polarity	Space if positive. Minus sign (-) if negative.	M	-
6	Heave	Heave value from -99.99 to +99.99 m. Shown as a four digit integer where the least significant bit = 0.01 m.	HHHH	0003
7	Status Flag	F if INS Active. H if INS has not completed an alignment.	Q	F

Field	Field Type	Description	Symbol	Example
8	Roll Polarity	Space if positive. Minus sign (-) if negative.	M	-
9	Roll	Roll value from -99.99 to +99.99 degrees. Shown as a four digit integer where the least significant bit = 0.01 degrees.	RRRR	0325
10	Space Character	A space delimiter.	S	
11	Pitch Polarity	Space if positive. Minus sign (-) if negative.	M	
12	Pitch	Pitch value from -99.99 to +99.99 degrees. Shown as a four digit integer where the least significant bit = 0.01 degrees.	PPPP	0319
13	[CR][LF]	Sentence terminator	<CR><LF>	

5.40 VARIABLELEVERARM

Display Variable Lever Arm Details

Platform: OEM719, OEM729, OEM7500, OEM7600, OEM7700, OEM7720, PwrPak7, SPAN CPT7, SMART7-S, SMART7-SI

Use this log to redisplay the re-calculated variable lever arm whenever a new **INPUTGIMBALANGLE** command is received. This message is output in the IMU body frame.



The **VARIABLELEVERARM** log will not be published or used internally unless a **SETINSROTATION RBM** command is sent. See the **SETINSROTATION** command on page 835.



This log should only be requested with the ONCHANGED or ONTIME trigger.

Message ID: 1320

Log Type: Asynch

Recommended Input:

```
log variableleverarma onnew
```

ASCII Example:

```
#VARIABLELEVERARMA,SPECIAL,0,81.5,FINESTEERING,1614,495820.512,42040000,0000,320;-0.0959421909646755,0.1226971902356540,1.1319295452903300,0.0100057787272846,0.0122604827412661,0.1131929545290330*9611d3c6
```

Field	Field Type	Description	Format	Binary Bytes	Binary Offset
1	VARIABLELEVERARM Header	Log header. See <i>Messages</i> on page 27 for more information.	-	H	0
2	XOffset	IMU body frame x-axis offset	Double	8	H
3	YOffset	IMU body frame y-axis offset	Double	8	H+8
4	ZOffset	IMU body frame z-axis offset	Double	8	H+16
5	XUncert	X-axis uncertainty in meters	Double	8	H+24
6	YUncert	Y-axis uncertainty in meters	Double	8	H+32
7	ZUncert	Z-axis uncertainty in meters	Double	8	H+40
8	xxxx	32-bit CRC (ASCII, Binary and Short Binary only)	Hex	4	H+48
9	[CR][LF]	Sentence terminator (ASCII only)	-	-	-

Chapter 6 Responses

The receiver is capable of outputting several responses for various conditions. Most responses are error messages to indicate when something is not correct.

The output format of the messages is dependent on the format of the input command. If the command is input as abbreviated ASCII, the output will be abbreviated ASCII. The same rule applies for both ASCII and binary formats.

Table 222: Response Messages

ASCII Message	Binary Message ID	Meaning
OK	1	Command was received correctly
Requested log does not exist	2	The log requested does not exist
Not enough resources in system	3	The request has exceeded a limit (for example, the maximum number of logs are being generated)
Data packet doesn't verify	4	Data packet is not verified
Command failed on receiver	5	Command did not succeed in accomplishing requested task
Invalid Message ID	6	The input message ID is not valid
Invalid Message. Field = x	7	Field x of the input message is not correct
Invalid Checksum	8	The checksum of the input message is not correct. Only applies to ASCII and binary format messages.
Message missing field	9	A field is missing from the input message
Array size for field x exceeds max	10	Field x contains more array elements than allowed
parameter x is out of range	11	Field x of the input message is outside the acceptable limits
Message Id already exists in system	12	Message Id already exists in system
Debug token unknown	13	Debug token unknown
Trigger x not valid for this log	14	Trigger type x is not valid for this type of log
Authcode table full - Reload Software	15	Too many authcodes are stored in the receiver. The receiver firmware must be reloaded

ASCII Message	Binary Message ID	Meaning
Invalid date format	16	This error is related to the inputting of authcodes. Indicates the date attached to the code is not valid
Invalid Authcode entered	17	The authcode entered is not valid
No matching model to remove	18	The model requested for removal does not exist
Not valid Auth code for that Model	19	The model attached to the authcode is not valid
Channel is invalid	20	The selected channel is invalid
Requested rate is invalid	21	The requested rate is invalid
Word has no mask for this type	22	The word has no mask for this type of log
Channels locked due to error	23	Channels are locked due to error (the receiver must be reset or power cycled to track satellites again)
Injected time invalid	24	Injected time is invalid
Com port not supported	25	The COM or USB port is not supported
Message is incorrect	26	The message is invalid
Invalid PRN	27	The PRN is invalid
PRN not locked out	28	The PRN is not locked out
PRN lockout list is full	29	PRN lockout list is full
PRN already locked out	30	The PRN is already locked out
Message timed out	31	Message timed out
Unknown COM port requested	33	Unknown COM or USB port requested
Hex string not formatted correctly	34	Hex string not formatted correctly
Invalid baud rate	35	The baud rate is invalid
Message is invalid for this model	36	Message is invalid for this model of receiver
Could Not Save Configuration	38	Could Not Save Configuration

ASCII Message	Binary Message ID	Meaning
Too Many Configuration Items	39	Too Many Configuration Items
Command only valid if in NVM Fail mode	40	Command is only valid if NVM is in fail mode
Invalid offset	41	The offset is invalid
File conflict	43	File conflict
File not found	44	File not found
File open	45	File open
File not open	46	File not open
Invalid DOS FileName	47	Invalid DOS File name
File channel in use	48	File channel in use
File close fail	50	File close fail
Disk not present	51	Disk not present
Disk error	52	Disk error
Disk full	53	Disk full
NVM Write Fail	74	NVM Write Fail
NVM Read Fail	75	NVM Read Fail
Not allowed for input	77	Not allowed for input
Maximum number of user messages reached	78	Maximum number of user messages has been reached
User message decryption failed	79	User message decryption failed
GPS precise time is already known	84	GPS precise time is already known
The message could not be created	87	The message could not be created
Not enough memory to start application	113	Not enough memory to start application
No data available	114	No data available
Invalid handshaking	117	Invalid handshaking

ASCII Message	Binary Message ID	Meaning
Message name already exists	118	Message name already exists
Invalid message name	119	Invalid message name
The datatype is invalid	120	The data type is invalid
Message ID is reserved	121	Message ID is reserved
Message size too large	122	Message size too large
Invalid Security Key	126	Invalid security key
Hardware not available	127	Hardware not available
Requested pulse width is invalid	131	Requested pulse width is invalid
Coarse time is not achieved yet	133	Coarse time is not achieved yet
Invalid Config Code	134	Invalid Config Code
ConfigCode table full - Reload Software	135	Config Code table is full. Reload the software.
Unknown Object Type	136	Unknown object type
This operation is not valid at this time	137	This operation is not valid at this time
User VARF in use	140	User VARF in use
Disk busy	142	Disk busy
Invalid Word Input Argument	143	Invalid Word Input Argument
Parameter %d is not valid for this model	148	The parameter specified is not valid for this model
IMU SPECS LOCKED FOR THIS IMU TYPE	150	SPAN allows the default specifications for a select few IMUs to be modified to support different variants. However, most IMU specifications are not allowed to change.
Invalid interface mode. Parameter %d	151	The specified Interface mode parameter is not valid.
COMMAND INVALID FOR THIS IMU	154	The entered command cannot be used with the configured IMU. For example, the INSCALIBRATE ANT1 command is not valid for lower quality IMUs.

ASCII Message	Binary Message ID	Meaning
IMU protocol is locked for this IMU type	155	IMU protocol is locked for this IMU type
IMU TYPE IS NOT SUPPORTED WITH CURRENT MODEL	157	A firmware model upgrade is required to use the requested IMU (CONNECTIMU command on page 812).
Trigger start time is invalid	159	Trigger start time is invalid
Sensor is not initialized	160	Sensor is not initialized
Board has not achieved finesteering	162	The receiver has not achieved finesteering
Invalid Profile Name	165	Invalid Profile Name
Maximum Number Profiles Exceeded	166	The maximum number of profiles is exceeded
Failed To Delete Profile	167	Failed to delete the profile
Profile Name Already Exists	168	Profile name already exists
Total Profile Commands Size Over Limit	169	Total Profile commands size over limit
Cannot Change Profile When Activated	170	Cannot change a Profile when it is activated
Signature Authcode Copy Fail	171	Signature Authcode copy fail
Profile Active, Could Not Save Configuration	173	Profile active, could not save configuration
Current PPP position has bad status and cannot be used for seeding	178	Current PPP position has bad status and cannot be used for seeding
PPP seed position failed integrity check	179	PPP seed position failed integrity check
Invalid password	180	Invalid password
Too many files	181	Too many files

ASCII Message	Binary Message ID	Meaning
Encryption key output is not allowed	186	Encryption key output is not allowed
Secure port requires login	187	Secure port requires login
NMEA2000/J1939 stack is already running on the CAN port	188	NMEA2000/J1939 stack is already running on the CAN port
No saved PPP seed position	191	No saved PPP seed position
System type is invalid for this model	192	System type is invalid for this model
Command is not supported for this model	193	Command is not supported for this model
Position Averaging Not Started	194	Position averaging not started
Not in GLIDE mode	200	Not in GLIDE mode
PPP seeding invalid in forced dynamics mode	201	PPP seeding invalid in forced dynamics mode
Wrong combination of parameters	202	Wrong combination of parameters
Invalid Calibration Request	203	Invalid calibration request
Active Gimbal Detected	204	Active gimbal detected
Authcode table full - Use auth erase_table	205	Authcode table full. An authcode must be removed before another authcode can be added. Refer to the AUTH command (see page 63) for instructions on removing authcodes and cleaning up the authcode table.
Profile Not Running - Profile should be activated	206	Profile not running - Profile should be activated
ID provided is already in use	208	ID provided is already in use
ID provided does not exist	209	ID provided does not exist

ASCII Message	Binary Message ID	Meaning
Calibration already in progress	210	Calibration already in progress
Filter cannot be enabled due to channel speed settings	211	Filter cannot be enabled due to channel speed settings
Notch Filter and Frequency are mismatching	212	Notch filter and frequency are mismatching
Filter can not cascade	213	Filter can not cascade
There is no RF filter applied	214	There is no RF filter applied
ID provided should be 4 character long	215	ID provided should be 4 characters long
Invalid subscription code	216	Invalid subscription code
Subscription table full	217	Subscription table full
Network id does not match subscription code	218	Network ID does not match the subscription code
Subscription not found	219	Subscription not found
Subscription not active	220	Subscription not active
Cannot activate expired subscription	221	Cannot activate expired subscription
Maximum number of logs exceeded. No new log added.	222	Maximum number of logs exceeded. No new log added.
Seed is too far in the past	223	Seed is too far in the past
Final log request must use the ONCE trigger	224	Final log request must use the ONCE trigger
Channel invalid for region x	225	Channel invalid for region x
Region not set	226	Region not set
Estimated RBV must be entered first	227	Initial RBV estimate is required before RBV calibration

ASCII Message	Binary Message ID	Meaning
Command failed because WIFIALIGNAUTOMATION is enabled	240	Command failed because WIFIALIGNAUTOMATION is enabled. See the WIFIALIGNAUTOMATION command on page 335.
Specified network not enabled with WIFINETCONFIG command	241	Specified network not enabled with WIFINETCONFIG command. See the WIFINETCONFIG command on page 343.

APPENDIX A Example of Bit Parsing a RANGEEMP4 Log

The following takes a sample RANGEEMP4 log and breaks it down into its raw components.

Data was captured in both RANGE and in RANGEEMP4 logs which are shown here for reference. These logs were captured at a rate of 4 Hz such that the Reference and Differential parts of the RANGEEMP4 could be explained.



Some of the RANGEEMP4 values will have some very slight differences (at the millicycle level) compared to the equivalent RANGE log data due to truncating the double values into integers.

Here are two RANGE logs to reference against once the RANGEEMP4 logs have been determined:

```
RANGE COM1 0 88.5 FINESTEERING 1919 507977.000 02000020 5103 32768
22
 27 0 21761200.335 0.036 -114355879.993103 0.006 1121.758 50.0 876.785
18109c04
 27 0 21761202.795 0.128 -89108485.029683 0.007 874.097 44.2 862.386 11303c0b
 27 0 21761200.306 0.007 -85395622.838987 0.004 837.685 51.7 865.845 01d03c04
 21 0 21214757.684 0.027 -111484302.588995 0.005 -1107.624 52.6 888.968
08109c24
 21 0 21214757.049 0.122 -86870882.607297 0.006 -863.084 44.6 874.389 01303c2b
 10 0 21540290.811 0.027 -113194996.162910 0.005 2288.688 52.6 889.905
08109c44
 10 0 21540293.632 0.110 -88203904.731314 0.006 1783.394 45.6 868.725 01303c4b
 10 0 21540289.869 0.006 -84528728.138216 0.004 1709.022 53.0 872.386 01d03c44
 15 0 21776375.653 0.032 -114435625.391762 0.007 -1814.485 50.9 879.586
18109c64
 15 0 21776376.038 0.129 -89170616.457446 0.007 -1413.886 44.1 862.706
11303c6b
 18 0 20493192.703 0.031 -107692454.149639 0.007 212.747 51.1 891.550 08109c84
 18 0 20493191.933 0.105 -83916195.494946 0.007 165.777 45.9 874.710 01303c8b
 61 9 20375330.794 0.104 -108956045.737322 0.006 -3039.481 46.8 891.931
08119ca4
 61 9 20375332.806 0.083 -84743599.055547 0.007 -2364.042 34.0 876.813
00b13cab
 55 4 22748433.080 0.146 -121432681.638722 0.009 4061.119 43.9 416.032
18119cc4
 55 4 22748438.602 0.021 -94447660.068923 0.009 3158.651 46.0 415.562 00b13ccb
 38 8 19781617.845 0.058 -105744080.698106 0.004 -2024.611 51.8 893.563
18119ce4
 38 8 19781623.453 0.032 -82245418.313339 0.005 -1574.698 42.2 878.833
00b13ceb
 39 3 19968976.955 0.055 -106558290.405759 0.004 2248.713 52.3 875.210
08119d04
 39 3 19968980.676 0.019 -82878686.553631 0.005 1749.000 46.9 870.890 00b13d0b
 54 11 19507573.213 0.059 -104388964.028915 0.005 1289.410 51.8 894.613
08119d24
 54 11 19507576.477 0.017 -81191427.275619 0.004 1002.874 48.0 878.832
10b13d2b
```

```

RANGE COM1 0 88.5 FINESTEERING 1919 507977.250 02000020 5103 32768
22
 27 0 21761146.982 0.036 -114355599.642256 0.006 1121.140 49.9 877.035
18109c04
 27 0 21761149.447 0.122 -89108266.573995 0.007 873.616 44.6 862.636 11303c0b
 27 0 21761146.957 0.007 -85395413.484293 0.004 837.294 51.8 866.095 01d03c04
 21 0 21214810.390 0.027 -111484579.560955 0.005 -1108.100 52.6 889.218
08109c24
 21 0 21214809.754 0.120 -86871098.429369 0.005 -863.454 44.8 874.639 01303c2b
 10 0 21540181.949 0.027 -113194424.080322 0.005 2288.176 52.6 890.155
08109c44
 10 0 21540184.767 0.111 -88203458.952394 0.006 1782.995 45.4 868.975 01303c4b
 10 0 21540181.003 0.006 -84528300.928648 0.004 1708.751 53.0 872.636 01d03c44
 15 0 21776461.990 0.032 -114436079.084785 0.006 -1814.956 50.9 879.836
18109c64
 15 0 21776462.375 0.129 -89170969.984233 0.007 -1414.253 44.1 862.956
11303c6b
 18 0 20493182.598 0.031 -107692401.054068 0.007 212.183 51.2 891.800 08109c84
 18 0 20493181.833 0.110 -83916154.122137 0.007 165.338 45.6 874.960 01303c8b
 61 9 20375472.914 0.104 -108956805.696703 0.006 -3040.142 46.9 892.181
08119ca4
 61 9 20375474.924 0.084 -84744190.134355 0.007 -2364.555 33.9 877.063
00b13cab
 55 4 22748242.897 0.150 -121431666.427728 0.009 4060.804 43.7 416.282
18119cc4
 55 4 22748248.421 0.021 -94446870.460803 0.009 3158.405 46.0 415.812 00b13ccb
 38 8 19781712.549 0.059 -105744586.938646 0.004 -2025.149 51.8 893.813
18119ce4
 38 8 19781718.158 0.032 -82245812.055601 0.005 -1575.117 42.3 879.083
00b13ceb
 39 3 19968871.615 0.055 -106557728.318448 0.004 2248.162 52.3 875.460
08119d04
 39 3 19968875.343 0.019 -82878249.374953 0.005 1748.571 46.8 871.140 00b13d0b
 54 11 19507512.994 0.059 -104388641.780659 0.005 1288.778 51.7 894.863
08119d24
 54 11 19507516.256 0.016 -81191176.637999 0.005 1002.383 48.1 879.082
10b13d2b

```

Here are the equivalent RANGEEMP4 logs which will be broken down into their individual components:

```

#RANGEEMP4A,COM1,0,88.5,FINESTEERING,1919,507977.000,02000020,fb0e,32768;295,
030000421204000000009200df7688831f611fd87ca0b03a00638bbdf7b82f49b080fd0ec0ff1f0
91f8214ff4d4d00a1009cbf1751f6911f5141f87fd9571a96dbd7040c8090f87f0080fcf722fe9b
fa8a49a8ff4f299d7f96fb9afefc771800fcffd0063f02cde01f3c7dd3fffb75240886f5fa2b0ff9
1f57f00003edf8b78868c882878014065dbf7d3ed6b722680d5fc0f00a4c08730fe7fecf8bffa3f
003008000000002001f03fa019f8136a11273649b8fcefab9c434c7b89e71560dbfe070030b2e04
fd841f33125320b80b0ecef5ee21243ac0bb03e0ffc36a813fb13bbe5791a0f5ff9e3bdbffbb87
f0cb8064f03f0000e4b67dd15bc5f4a50a3a006ca72fdee53ec86405b2c0ffa3fa450f725d5bfe
d7c49b1fb0fb16b45a87a9adb0740cbfe0700*7DD8F893

```

```

#RANGEEMP4A,COM1,0,88.5,FINESTEERING,1919,507977.250,02000020,fb0e,32768;239,
030000421204000000009200dff688831f6102005500e70162dc977c004015c07988840f6101803
a805921cedf8b80002011207080e5f6351f003804081c2200be0808005c01620808725f93028057

```

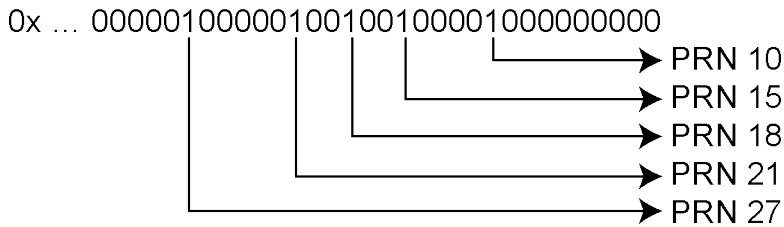

- Grab the next 8 bytes (64 bits) = 0x0042120400000000
- Swap the bytes = 0x0000000004124200
- 0x0000000004124200 in binary form =



- The 1's above identify that there are 5 tracking GPS PRNs.

GPS Signals field (16 bits)

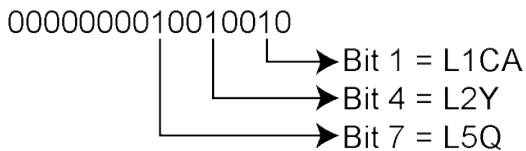
- Grab the next 2 bytes (16 bits) = 0x9200
- Swap the bytes = 0x0092
- 0x0092 in binary form =



- The 1's above identify that there are 3 tracking GPS signals: L1CA, L2Y, and L5Q.

GPS Included Signals field (5 PRNs x 3 Signals = 15 bits – Therefore need 2 bytes)

- Up to the point of processing the Included Signals field, the bytes are aligned such that the bits start and end within each batch of bytes. After processing this step, it is quite common for the Included Signals Field (mxn matrix) to not be divisible by 8 so bytes not processed will need to be carried over to the next section depending on the size of the matrix.
- Grab the next 2 bytes (16 bits) = 0xdf76
- Swap the bytes = 0x76df
- 0x76df in binary form = 0111011011011111
- Only need 15 of the 16 bits = X111011011011111
- This bit string breaks down into 5 rows (PRNs) and 3 columns (signals) as specified by the mxn (PRN x signals) parameters. Take the bit string and break it up into sets of 3 starting at the MSB. This will result with the lowest PRN being at the bottom row of the stack and the first signal (L1CA) being the far right column.

```

111
011
011
011
111
    
```

- This stack can be further broken apart to identify the PRNs vs. their Signals:

PRN	L5Q	L2Y	L1CA
27	1	1	1
21	0	1	1
18	0	1	1

15	0	1	1
10	1	1	1

A.1.3 Reference Measurement Block Header: GPS

This block is sent once for each bit set to 1 in the Satellites field found in *Table 134: Satellite and Signal Block* on page 633. Now that the PRN's signals have been determined, the next step is to determine the specifics of the first PRN (10) and its list of signals (L1CA, L2Y, L5Q). Working from bottom right to upper left of the PRN/Signal chart above, each 1 represents a signal for a PRN. Use *Table 135: Measurement Block Header* on page 634 to determine the contents of each field:

GPS PRN 10 (first PRN found in the Satellites field)

We will grab enough bytes to process the whole Measurement Block Header. If this was a GLONASS System, a total of 9 bits would be required for this step (1 bit for the Data Format Flag, 3 bits for the Ref Data Block ID, plus 5 bits for the GLONASS Frequency Number). Since this is a GPS system, only 4 bits in total are required (1 bit for the Data Format Flag and 3 bits for the Ref Data Block ID).

There was 1 bit not processed in the last byte so that byte will be carried forward. Only 4 bits need to be looked at for this step so grab the next byte as well:

- Use the last byte (0x76) plus the next byte (0x88) = 0x7688
- Swap the bytes = 0x8876
- 0x8876 in binary form = 1000100001110110
- Ignore the 7 processed bits from the last step = 100010000XXXXXX
- Ignore the 5 MSB bits leaving 4 bits for processing =
 XXXXX0000XXXXXXXX
 0 = Data Format Flag (1 bit)
 000 = Ref Data Block (3 bits)

The Data Format Flag identifies that this batch of data is Reference (0) data.
The Ref Data Block ID is 0x000.



The 5 MSBs have not been processed so this byte will be carried forward.

The Data Format Flag identifies if the upcoming data is Reference or Differential data. By default every log that was published on a whole second will always be Reference logs. Logs between seconds will be Differential logs but could be Reference logs depending on the compression calculations. If a discontinuity occurred that made it impossible for a Differential calculation to fit within the Differential Constraints, it will revert to a Reference log.

A.1.4 Reference Measurement Block: GPS

This block is sent once for each bit set to 1 in the Included Signals Field found in *Table 134: Satellite and Signal Block* on page 633. Use *Table 136: Primary Reference Signal Measurement Block* on page 635 and *Table 137: Secondary Reference Signals Measurement Block* on page 636 to determine the contents of each field:

A Measurement Block for a single PRN will look like the following:

Primary Parity Flag

Primary 1/2 Cycle Slip Flag
Primary C/No
Primary Lock Time
Primary Pseudorange Std Deviation
Primary Phaserange Std Deviation
Primary Pseudorange
Primary Phaserange - Primary Pseudorange (determines the Phaserange for the 1st Signal)
Primary Doppler

2nd Parity Flag
2nd 1/2 Cycle Slip Flag
2nd C/No
2nd Lock Time
2nd Pseudorange Std Deviation
2nd Phaserange Std Deviation
2nd Pseudorange - Primary Pseudorange (determines the Pseudorange for the 2nd Signal)
2nd Phaserange - 2nd Pseudorange (determines the Phaserange for the 2nd Signal)
2nd Doppler - Primary Doppler (determines the Doppler for the 2nd Signal)

3rd Parity Flag
3rd 1/2 Cycle Slip Flag
3rd C/No
3rd Lock Time
3rd Pseudorange Std Deviation
3rd Phaserange Std Deviation
3rd Pseudorange - Primary Pseudorange (determines the Pseudorange for the 3rd Signal)
3rd Phaserange - 3rd Pseudorange (determines the Phaserange for the 3rd Signal)
3rd Doppler - Primary Doppler (determines the Doppler for the 3rd Signal)

...

A.1.5 Reference Primary Signal Measurement Block: GPS PRN 10 – L1CA

The next bytes collected will be for the GPS PRN 10 - L1CA signal data. This is the primary signal of the PRN since it is the first signal. As a result, its Measurement Block consists of 111 bits as listed in *Table 136: Primary Reference Signal Measurement Block* on page 635. Since 111 bits takes up a lot of space, these bits will be split into two groups from *Table 136: Primary Reference Signal Measurement Block* on page 635: the top 25 bits for signal info followed by the bottom 86 bits for signal data.

The signal info section (top 25 bits) is processed as follows:

- With 5 bits left unprocessed from the previous byte, we calculate $25 - 5 = 20$ bits which rounds up to 3 bytes. Therefore the previous last byte (0x88) plus the next 3 bytes will be needed.
 - Use the last byte (0x88) plus grab 3 bytes (x831f61) = 0x88831f61
 - Swap the bytes = 0x611f8388
 - 0x611f8388 in binary form = 01100001000111111000001110001000
 - The previous step used the 3 LSBs = 01100001000111111000001110001XXX
 - 25 bits are needed so ignore the 4 MSBs =

```

xxxx0001000111111000001110001xxx
                                1   = Parity Flag
                                0   = 1/2 Cycle Slip Flag
                                10000011100 = C/No
                                1111      = Lock Time
                                0001      = Pseudorange Std Deviation
                                0001      = Phaserange Std Deviation
    
```

- Parity flag is a 1 (Parity Known)
- 1/2 Cycle Slip flag is a 0 (Cycle Slip Not Present)
- C/No is:
0x10000011100b = 1052 x Scaling Factor of 0.05
= 52.60 dBHz
- The Lock Time value is:
0x1111b = 15 which means that this signal has been locked for 262144 ms or more.
- The Pseudorange Std Deviation value is:
0x0001b = 1 which means: 0.020 m < PSR Std Dev <= 0.030 m using *Table 143: Pseudorange Std Dev* on page 642.
- The ADR Std Deviation value is:
0x0001b = 1 which means: 0.0039 < ADR Std Dev <= 0.0052 cycles using *Table 142: ADR Std Dev* on page 641.

The signal data section (bottom 86 bits) is processed as follows:

- With 4 bits unprocessed from the previous byte, we calculate $86 - 4 = 82$ bits = 11 bytes (2 bits will not be processed in the last byte).
 - Use the last byte (0x61) plus grab 11 bytes (0x1fd87ca0b03a00638bbdf7) = 0x611fd87ca0b03a00638bbdf7
 - Swap the bytes = 0xf7bd8b63003ab0a07cd81f61
 - 0xf7bd8b63003ab0a07cd81f61 in binary form =
111 0111 1011 1101 1000 1011 0110 0011 0000 0000 0011 1010 1011 0000 1010 0000
0111 1100 1101 1000 0001 1111 0110 0001
 - Only need 86 bits. Ignore last 4 LSBs and first 6 MSBs =

```

xxxx xx11 1011 1101 1000 1011 0110 0011 0000 0000 0011 1010 1011 0000 1010 0000 0111 1100 1101 1000 0001 1111 0110 xxxx
                                0 1010 0000 0111 1100 1101 1000 0001 1111 0110 = 1st Pseudo
                                0000 0000 0011 1010 1011 000 = 1st Phase - 1st Pseudo
                                11 1011 1101 1000 1011 0110 0011 = 1st Doppler
    
```

- Use *Table 136: Primary Reference Signal Measurement Block* on page 635 to identify if a 2's Complement Conversion is needed as well as what Scale Factor should be used before these binary numbers are used in the following calculations.
- The 1st (Primary) Pseudorange is processed by:

$$\text{1st Pseudorange} = 0x0101000000111110011011000000111110110b \times \text{Scaling Factor}$$

$$\text{1st Pseudorange} = 43080581622 \times 0.0005$$

$$\text{L1CA Pseudorange for PRN 10} = 21540290.811 \text{ m}$$
- The 1st (Primary) Phasorange is a 2's Complement number (as identified by the Range column in *Table 136: Primary Reference Signal Measurement Block* on page 635) so it is processed in the following manner:

$$\text{1st Phasorange} - \text{1st Pseudorange} = 2's \text{ Complement}(0x00000000001110101011000b) * \text{Scaling Factor}$$

$$\text{1st Phasorange} - 21540290.811 \text{ m} = 7512 * 0.0001$$

$$\text{L1CA Phasorange} = 21540291.5622 \text{ m}$$
- Convert this to ADR to check against the original RANGE log:

$$\text{ADR} = \text{1st Phasorange} * \text{Frequency} * (-1) / \text{Speed Of Light}$$

$$\text{ADR} = 21540291.5622 \text{ m} * 1575420000 \text{ Hz} * (-1) / 299792458 \text{ m/s}$$

$$\text{L1CA ADR for PRN 10} = -113194996.1627158 \text{ cycles}$$



In the range logs, PSR and ADR have opposite signs.

- The 1st (Primary) Doppler is a 2's Complement number (as identified by the Range column in *Table 136: Primary Reference Signal Measurement Block* on page 635) so it is processed in the following manner:

$$\text{1st Doppler(m/s)} = 2's \text{ Complement}(0x11101111011000101101100011b) \times \text{Scaling Factor}$$

$$\text{1st Doppler(m/s)} = -4,355,229 \times 0.0001$$

$$\text{L1CA Doppler(m/s)} = -435.5229 \text{ m/s}$$

Convert the Doppler to Hz:

$$\text{1st Doppler(Hz)} = \text{1st Doppler(m/s)} \times \text{Frequency} * (-1) / \text{Speed Of Light}$$

$$\text{L1CA Doppler(Hz) for PRN 10} = 2288.6883 \text{ Hz}$$

$$\text{1st Doppler(Hz)} = -435.5229 \text{ m/s} \times 1575420000 \text{ Hz} * (-1) / 299792458 \text{ m/s}$$

A.1.6 Reference Secondary Signals Measurement Block: GPS PRN 10 – L2Y

Signal L1CA was the 1st signal (Primary Signal) of the three PRN 10 signals found in this RANGECMP4 log data. L1CA's data is now used to determine the L2Y's signals data. Since this is the second signal block of this PRN, its data will be processed by using *Table 137: Secondary Reference Signals Measurement Block* on page 636.

With 6 bits left unprocessed from the previous byte, we will require $82 - 6 = 76$ bits which rounds up to 10 bytes.

- Use the last byte (0xf7) plus grab the next 10 bytes (0xb82f49b080fd0ec0ff1f)

$$= 0xf7b82f49b080fd0ec0ff1f$$
- Swap the bytes = 0x1fffc00efd80b0492fb8f7
- 0x1fffc00efd80b0492fb8f7 in binary form =

$$0001\ 1111\ 1111\ 1111\ 1100\ 0000\ 0000\ 1110\ 1111\ 1101\ 1000\ 0000\ 1011\ 0000\ 0100\ 1001\ 0010$$

1111 1011 1000 1111 0111

- Only need 78 bits. The 2 LSBs are ignored as they were already processed above and the 4 MSBs are ignored so there is a total of 82 bits to process

```

xxxx 1111 1111 1111 1100 0000 0000 1110 1111 1101 1000 0000 1011 0000 0100 1001 0010 1111 1011 1000 1111 01XX
                                                                                                     1 = Parity Flag
                                                                                                     0 = 1/2 Cycle Slip Flag
                                                                                                     = C/No
                                                                                                     = Lock Time
                                                                                                     = Pseudorange Std Deviation
                                                                                                     = Phasorange Std Deviation
                                                                                                     = Pseudo - 1st Pseudo
                                                                                                     = Phase - Pseudo
                                                                                                     = Doppler - 1st Doppler
                                                                                                     011 1000 1111
                                                                                                     111 1
                                                                                                     010 1
                                                                                                     001 0
                                                                                                     000 0000 1011 0000 0100 1
                                                                                                     00 0000 0000 1110 1111 1101 1
                                                                                                     1111 1111 1111 11
    
```

Use *Table 137: Secondary Reference Signals Measurement Block* on page 636 to identify if a 2's Complement Conversion is needed as well as what Scale Factor should be used before these binary numbers are used in the following calculations.

- Parity flag is a 1 (Parity Known)
- 1/2 Cycle Slip flag is a 0 (Cycle Slip Not Present)
- C/No is:
 $0x01110001111b = 911 \times \text{Scaling factor of } 0.05$
 $= 45.55 \text{ dBHz}$
- The Lock Time value is:
 $0x1111b = 15$ which means that this signal has been locked for 262144 ms or more.
- The Pseudorange Std Deviation value is:
 $0x0101b = 5$ which means: $0.099 \text{ m} < \text{PSR Std Dev} \leq 0.148 \text{ m}$ using *Table 143: Pseudorange Std Dev* on page 642.
- The ADR Std Deviation value is:
 $0x0010b = 2$ which means: $0.0052 < \text{ADR Std Dev} \leq 0.0070 \text{ cycles}$ using *Table 142: ADR Std Dev* on page 641.
- The L2Y Pseudorange is a 2's Complement number (as identified by the Range column in *Table 137: Secondary Reference Signals Measurement Block* on page 636) so it is processed in the following manner:
 $\text{Pseudorange} - 1\text{st Pseudorange} = 2's \text{ Complement}(0x00000001011000001001b) \times \text{Scaling Factor}$
 $\text{Pseudorange} - 21540290.811 \text{ m} = 5641 \times 0.0005$
 $2Y \text{ Pseudorange} = 21540293.6315 \text{ m}$
- The L2Y Phasorange is a 2's Complement number (as identified by the Range column in *Table 137: Secondary Reference Signals Measurement Block* on page 636) so it is calculated in the following manner:
 $\text{Phasorange} - \text{Pseudorange} = 2's \text{ Complement}(0x0000000000111011111011b) \times \text{Scaling Factor}$
 $\text{Phasorange} - 21540293.6315 \text{ m} = 7675 \times 0.0001$
 $L2Y \text{ Phasorange} = 21540294.399 \text{ m}$
- Convert this to ADR to check against the original RANGE log:
 $\text{ADR} = \text{Phasorange} \times \text{Frequency} \times (-1)/\text{Speed Of Light}$
 $\text{ADR} = 21540294.399 \text{ m} \times 1227600000 \text{ Hz} \times (-1)/299792458 \text{ m/s}$
 $L2Y \text{ ADR for PRN } 10 = -88203904.73002626 \text{ cycles}$



In the range logs, PSR and ADR have opposite signs.

- The L2Y Doppler is a 2's Complement number (as identified by the Range Column in *Table 137: Secondary Reference Signals Measurement Block* on page 636) so it is calculated in the following manner:

$$\begin{aligned} \text{Doppler(m/s)} - \text{1st Doppler(m/s)} &= 2's \text{ Complement}(0x1111111111111111b) \times \text{Scaling Factor} \\ \text{Doppler(m/s)} - (-435.5229 \text{ m/s}) &= (-1) \times 0.0001 \\ \text{L2Y Doppler(m/s)} &= -435.5228 \text{ m/s} \end{aligned}$$

Convert the Doppler to Hz:

$$\begin{aligned} \text{Doppler(Hz)} &= \text{Doppler(m/s)} \times \text{Frequency} \times (-1) / \text{Speed Of Light} \\ \text{Doppler(Hz)} &= -435.5228 \text{ m/s} \times 1227600000 \text{ Hz} \times (-1) / 299792458 \text{ m/s} \\ \text{L2Y Doppler(Hz) for PRN 10} &= 1783.3938 \text{ Hz} \end{aligned}$$

A.1.7 Reference Third Signals Measurement Block: GPS PRN 10 – L5Q

Signal L1CA was the 1st signal (Primary Signal) of the three PRN 10 signals found in this RANGEEMP4 log data. L1CA's data is now used to determine the L5Q's signals data. Since this is the third signal block of this PRN, its data will be processed using *Table 137: Secondary Reference Signals Measurement Block* on page 636.

With 4 bits left unprocessed from the previous byte, we will require $82 - 4 = 78$ bits which rounds up to 10 bytes.

- Use the last byte (0x1f) plus grab the next 10 bytes (0x091f8214ff4d4d00a100) = 0x1f091f8214ff4d4d00a100
- Swap the bytes = 0x00a1004d4dff14821f091f
- 0x00a1004d4dff14821f091f in binary form =
0000 0000 1010 0001 0000 0000 0100 1101 0100 1101 1111 1111 0001 0100 1000 0010 0001 1111 0000 1001 0001 1111
- Only need 78 bits. The 4 LSBs are ignored as they were already processed above and the 2 MSBs are ignored so there is a total of 82 bits to process

```

xx00 0000 1010 0001 0000 0000 0100 1101 0100 1101 1111 1111 0001 0100 1000 0010 0001 1111 0000 1001 0001 xxxx
                                                                                                     1
                                                                                                     0
                                                                                                     1 0000 1001 00
                                                                                                     1 111
                                                                                                     0 000
                                                                                                     0 001
                                                                                                     1 1111 1111 0001 0100 100
00 0000 1010 0001 0000 0000 0100 1101 0100 110
                                                                                                     = Parity Flag
                                                                                                     = 1/2 Cycle Slip Flag
                                                                                                     = C/No
                                                                                                     = Lock Time
                                                                                                     = Pseudorange Std Deviation
                                                                                                     = Phasorange Std Deviation
                                                                                                     = Pseudo - 1st Pseudo
                                                                                                     = Phase - Pseudo
                                                                                                     = Doppler - 1st Doppler
    
```

Use *Table 137: Secondary Reference Signals Measurement Block* on page 636 to identify if a 2's Complement Conversion is needed as well as what Scale Factor should be used before these binary numbers are used in the following calculations.

- Parity flag is a 1 (Parity Known)
- 1/2 Cycle Slip flag is a 0 (Cycle Slip Not Present)
- C/No is:
 $0x10000100100b = 1060 \times \text{Scaling Factor of } 0.05 = 53.00 \text{ dBHz}$
- The Lock Time value is:
 $0x1111b = 15$ which means that this signal has been locked for 262144 ms or more.

- The Pseudorange Std Deviation value is:
0x0000b = 0 which means: PSR Std Dev \leq 0.020 m using *Table 143: Pseudorange Std Dev* on page 642.
- The ADR Std Deviation value is:
0x0001b = 1 which means: $0.0039 < \text{ADR Std Dev} \leq 0.0052$ cycles using *Table 142: ADR Std Dev* on page 641.
- The L5Q Pseudorange is a 2's Complement number (as identified by Range column in *Table 137: Secondary Reference Signals Measurement Block* on page 636) so it is processed in the following manner:
Pseudorange – 1st Pseudorange = 2's Complement(0x11111111100010100100b) x Scaling Factor
Pseudorange – 21540290.811 m = (-1884) x 0.0005
L5Q Pseudorange = 21540289.869 m
- The L5Q Phaserange is a 2's Complement number (as identified by the Range column in *Table 137: Secondary Reference Signals Measurement Block* on page 636) so it is calculated in the following manner:
Phaserange – Pseudorange = 2's Complement(0x00000000010011010100110b) * Scaling Factor
Phaserange – 21540289.869 m = 9894 * 0.0001
L5Q Phaserange = 21540290.8584 m
- Convert this to ADR to check against the original RANGE log:
ADR = Phaserange * Frequency * (-1)/Speed Of Light
ADR = 21540290.8584 m * 1176450000 Hz * (-1)/299792458 m/s
L5Q ADR for PRN 10 = -84528728.13886692 cycles



In the range logs, PSR and ADR have opposite signs.

- The L5Q Doppler is a 2's Complement number (as identified by the Range column *Table 137: Secondary Reference Signals Measurement Block* on page 636) so it is calculated in the following manner:
Doppler(m/s) – 1st Doppler(m/s) = 2's Complement(0x00000010100001b) x Scaling Factor
Doppler(m/s) – (-435.5229 m/s) = 80 x 0.0001
L5Q Doppler(m/s) = -435.5149 m/s
Convert the Doppler to Hz:
Doppler(Hz) = Doppler(m/s) x Frequency * (-1)/Speed Of Light
Doppler(Hz) = -435.5149 m/s x 1176450000 Hz * (-1)/299792458 m/s
L5Q Doppler(Hz) for PRN 10 = 1709.054 Hz

This concludes the processing of the signals present for PRN 10.

The next PRN as identified in the GPS Included Signals Field is PRN 15 with 2 signals. Processing of this data would be handled as described above, starting with the 4 bit Measurement Block followed by the individual signals. This would be followed by PRN 18, 21, and 27. Processing these remaining PRNs and their signals would use up the next 870 bits as shown below:

Bits required for remaining GPS PRNs and Signals:

PRN 15

starting at the MSB. This will result with the lowest Slot ID being at the bottom row of the stack and the first signal (L1CA) being the far right column.

```
11
11
11
11
11
```

- This stack can be further broken apart to identify the Slot ID's vs. their Signals:

SLOT	L2P	L1CA
24	1	1
18	1	1
17	1	1
2	1	1
1	1	1

A.1.9 Reference Measurement Block Header: GLONASS PRN 38

(Slot 1 which was the first Slot found in the Satellites Field)

We will grab enough bytes to process the whole Measurement Block Header. Since this is a GLONASS System, a total of 9 bits will be required for this step (1 bit for the Data Format Flag, 3 bits for the Ref Data Block ID, plus 5 bits for the GLONASS Frequency Number).

With 2 bits left unprocessed from the previous byte, we will require $9 - 2 = 7$ bits which rounds up to 1 byte:

- Use the last byte (0x3f) plus the next byte (0xa0) = 0x3fa0
- Swap the bytes = 0xa03f
- 0xa03f in binary form = 1010000000111111
- Ignore the 6 processed bits from the last step = 1010000000XXXXXX
- Ignore the 1 MSB bits leaving 9 bits for processing =

```
x010000000XXXXXX
      0          = Data Format Flag (1 bit)
     000        = Ref Data Block (3 bits)
    01000      = GLONASS Freq Number (5 bits)
```

The Data Format Flag identifies that this batch of data is Reference (0) data.

The Ref Data Block ID is 0x000.

The GLONASS Frequency Number is 8 (adjusted to 1). When calculating the GLONASS Carrier frequency, this value (0 to 20) will be adjusted to its -7 to +13 value and then multiplied by that frequencies delta. Note that this field only appears in the Reference data and will not be found in the Differential data.



Special Case: When the Slot ID is between 43 and 63, the Slot ID of the GLONASS satellite is unknown. In order to keep track of which satellite it is for these calculations, the Frequency Number is used to assign this GLONASS Satellite a temporary Slot ID based on the GLONASS Frequency Numbers binary value of 0 to 20.

A.1.10 Reference Primary Signal Measurement Block: GLONASS PRN 38 – L1CA

The next bytes collected will be for the GLONASS PRN 38 - L1CA signal data. This is the primary signal of the satellite since it is the first signal. As a result, its Measurement Block consists of 111 bits as listed in *Table 136: Primary Reference Signal Measurement Block* on page 635. Since 111 bits takes up a lot of space, these bits will be split into two groups from *Table 136: Primary Reference Signal Measurement Block* on page 635: the top 25 bits for signal info followed by the bottom 86 bits for signal data.

The signal info section (top 25 bits) is processed as follows:

- With 1 bit left unprocessed from the previous byte, we calculate $25 - 1 = 24$ bits which equals 3 bytes. Therefore the previous last byte (0xa0) plus the next 3 bytes will be needed.

- Use the last byte (0xa0) plus grab 3 bytes (x19f813) = 0xa019f813
- Swap the bytes = 0x13f819a0
- 0x13f819a0 in binary form = 00010011111110000001100110100000
- The previous step used the 7 LSBs = 0001001111111000000110011XXXXXXX
- Need 25 bits which is exactly what is left over:

```

0001001111111000000110011XXXXXXX
                                1      = Parity Flag
                                1      = ½ Cycle Slip Flag
                        10000001100    = C/No
                1111                  = Lock Time
        0011                          = Pseudorange Std Deviation
0001                                  = Phasorange Std Deviation

```

- Parity flag is a 1 (Parity Known)
- ½ Cycle Slip flag is a 1 (Cycle Slip Present)
- C/No is:
0x10000001100b = 1036 x Scaling factor of 0.05
= 51.80 dBHz
- The Lock Time value is:
0x1111b = 15 which means that this signal has been locked for 262144 ms or more.
- The Pseudorange Std Deviation value is:
0x0011b = 3 which means: $0.045 \text{ m} < \text{PSR Std Dev} \leq 0.066 \text{ m}$ using *Table 143: Pseudorange Std Dev* on page 642.
- The ADR Std Deviation value is:
0x0001b = 1 which means: $0.0039 < \text{ADR Std Dev} \leq 0.0052$ cycles using *Table 142: ADR Std Dev* on page 641.

The signal data section (bottom 86 bits) is processed as follows:

- With no unprocessed bits from the previous byte, we need 86 bits which rounds up to 11 bytes.

- Grab 11 bytes = 0x6a11273649b8fcefab9c43
- Swap the bytes = 0x439cabeffcb8493627116a
- 0x439cabeffcb8493627116a in binary form =

0100 0011 1001 1100 1010 1011 1110 1111 1111 1100 1011 1000 0100 1001 0011 0110
0010 0111 0001 0001 0110 1010

- Only need 86 bits. Ignore first 2 MSBs =

```

XX00 0011 1001 1100 1010 1011 1110 1111 1111 1100 1011 1000 0100 1001 0011 0110 0010 0111 0001 0001 0110 1010
                                0 1001 0011 0110 0010 0111 0001 0001 0110 1010 = 1st Pseudo
                                1111 1111 1100 1011 1000 010 = 1st Phase - 1st Pseudo
00 0011 1001 1100 1010 1011 1110 = 1st Doppler
  
```

- Use *Table 136: Primary Reference Signal Measurement Block* on page 635 to identify if a 2's Complement Conversion is needed as well as what Scale Factor should be used before these binary numbers are used in the following calculations.
- The 1st (Primary) Pseudorange is processed by:
 - 1st Pseudorange = 0x010010011011000100111000100010110101010b x Scaling Factor
 - 1st Pseudorange = 39563235690 x 0.0005
 - L1CA Pseudorange for PRN 38 = 19781617.845 m
- The 1st (Primary) Phasorange is a 2's Complement number (as identified by the Range column in *Table 136: Primary Reference Signal Measurement Block* on page 635) so it is processed in the following manner:
 - 1st Phasorange – 1st Pseudorange = 2's Complement(0x11111111110010111000010b) * Scaling Factor
 - 1st Phasorange – 19781617.845 m = -6718 * 0.0001
 - L1CA Phasorange = 19781617.1732 m
- Convert this to ADR to check against the original RANGE log:
 - ADR = 1st Phasorange * (Carrier Frequency + Frequency Number * 562500 Hz) * (-1)/Speed Of Light
 - ADR = 19781617.1732 m * (1602000000 Hz + 1 * 562500 Hz) * (-1)/299792458 m/s
 - ADR = 19781617.1732 m * 1602562500 Hz * (-1)/299792458 m/s
 - L1CA ADR for PRN 38 = -105744080.6970745 cycles

 In the range logs, PSR and ADR have opposite signs.

- The 1st (Primary) Doppler is a 2's Complement number (as identified by the Range column in *Table 136: Primary Reference Signal Measurement Block* on page 635) so it is processed in the following manner:
 - 1st Doppler(m/s) = 2's Complement(0x00001110011100101010111110b) x Scaling Factor
 - 1st Doppler(m/s) = 3787454 m/s x 0.0001
 - L1CA Doppler(m/s) = 378.7454 m/s
 - Convert the Doppler to Hz:
 - 1st Doppler(Hz) = 1st Doppler(m/s) x (Carrier Frequency + Frequency Number * 562500 Hz) * (-1)/Speed Of Light
 - 1st Doppler(Hz) = 378.7454 m/s x (1602000000 Hz + 1 * 562500 Hz) * (-1)/299792458 m/s
 - 1st Doppler(Hz) = 378.7454 m/s x 1602562500 Hz * (-1)/299792458 m/s
 - L1CA Doppler(Hz) for PRN 38 = -2024.6112 Hz

The rest of the GLONASS Reference Signals are handled in a similar manner as described in the above GPS section.

A.2 Differential Log Decoding

Logs not falling on a whole second are most likely Differential logs which are processed differently than the Reference logs. It is possible for a sub-second RANGECMP4 log to be a Reference log if the data contained within it did not fit the tight Differential Compression requirements.

Differential logs use the reference data of the same signal unlike reference logs which uses the first signal to define the other signals.

The next RANGECMP4 log is at time 507977.250:

```
#RANGECMP4A, COM1, 0, 88.5, FINESTEERING, 1919, 507977.250, 02000020, fb0e, 32768;239,
0300004212040000000009200dff688831f6102005500e70162dc977c004015c07988840f6101803
a805921cedf8b80002011207080e5f6351f003804081c2200be0808005c01620808725f93028057
801822dae0476000a00f207180fef6251700e803401c62f3bdc8060052013009986f5f220200540
04ca2053ec408005401ca8701804100000000000980ff6306fec408004801de07c8692f51028051
80f721b2e04f600040152081804ef7102500600540202205fe040a0086013a0938780f610200618
04e224edbdb68002010c0498030f7411d0018047812a2d47d090a004c01a609c8544f6202805200
6a02*48E189A2
```

At the start of the RANGECMP4 log is the identifier for how many bytes are in the log. In this case, there are 239 bytes (just under 20% less than a Reference Log). The rest of the message is compressed binary data and is transmitted as LSB first so the bytes must be swapped before processing.

A.2.1 Differential Header

The Differential Header is sent once per message (See *Table 133: Header* on page 633).

Decoding the bits starting with the first bytes:

GNSS field (16 bits)

- Grab the first 2 bytes (16 bits) = 0x0300
- Swap the bytes = 0x0003
- 0x0003 in binary form =

```
0000 0000 0000 0011
    |
    |└─> Bit 0 = GPS
    └─> Bit 1 = GLONASS
```



In this example the receiver was configured to track only GPS and GLONASS systems. If other systems had been in the configuration and tracked, they would have shown here.

A.2.2 Differential Satellite and Signal Block

This block is sent once for each bit set to 1 in the GNSS field found in *Table 133: Header* on page 633. As identified by the above GNSS field, the first system (right to left) is the GPS System. Use *Table 134: Satellite and Signal Block* on page 633 to determine what satellites and signals data are contained in this GPS System:

GPS Satellites field (64 bits)

- Grab the next 8 bytes (64 bits) = 0x0042120400000000
- Swap the bytes = 0x...0000000004124200
- 0x0000000004124200 in binary form =

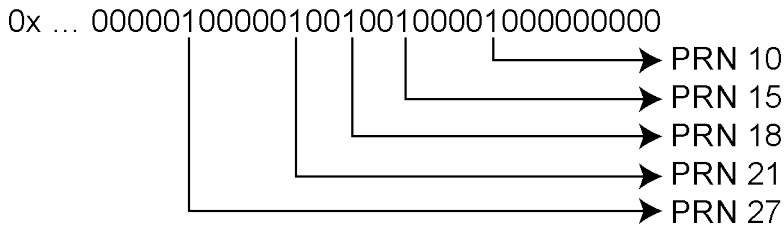

- The 1's above identify that there are 5 tracking GPS PRNs.

GPS Signals field (16 bits)

- Grab the next 2 bytes (16 bits) = 0x9200
- Swap the bytes = 0x0092
- 0x0092 in binary form =

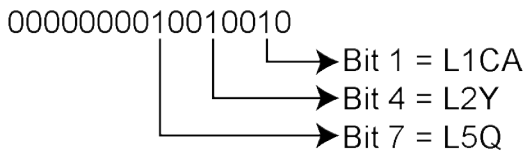

- The 1's above identify that there are 3 tracking GPS signals: L1CA, L2Y, and L5Q.

GPS Included Signals field (5 PRNs x 3 Signals = 15 bits – therefore need 2 bytes)

Up to the point of processing the Included Signals field, the bytes are aligned such that the bits start and end within each batch of bytes. After processing this step, it is quite common for the Included Signals field (mxn matrix) to not be divisible by 8 so bytes not processed will need to be carried over to the next section depending on the size of the matrix.

- Grab the next 2 bytes (16 bits) = 0xdff6
- Swap the bytes = 0xf6df
- 0xf6df in binary form = 1111011011011111
- Only need 15 of the 16 bits = X111011011011111
- This bit string breaks down into 5 rows (PRNs) and 3 columns (signals) as specified by the mxn (PRN x signals) parameters. Take the bit string and break it up into sets of 3 starting at the MSB. This will result with the lowest PRN being at the bottom row of the stack and the first signal (L1CA) being the far right column.

```

111
011
011
011
111
    
```

- This stack can be further broken apart to identify the PRNs vs. their Signals:

PRN	L5Q	L2Y	L1CA
27	1	1	1
21	0	1	1
18	0	1	1

15	0	1	1
10	1	1	1

A.2.3 Differential Measurement Block Header

This block is sent once for each bit set to 1 in the Satellites field found in *Table 134: Satellite and Signal Block* on page 633. Now that the PRN's signals have been determined, the next step is to determine the specifics of the first PRN (10) and its list of signals (L1CA, L2Y, L5Q). Working from bottom right to upper left of the PRN/Signal chart above, each 1 represents a signal for a PRN. Use *Table 135: Measurement Block Header* on page 634 to determine the contents of each field:

GPS PRN 10 (first PRN found in the Satellites field)

We will grab enough bytes to process the whole Measurement Block Header. If this was a GLONASS system, a total of 9 bits would be required at this step (1 bit for the Data Format Flag, 3 bits for the Ref Data Block ID, plus 5 bits for the GLONASS Frequency Number). Since this is a GPS system, only 4 bits in total are required (1 bit for the Data Format Flag and 3 bits for the Ref Data Block ID).

There was 1 bit not processed in the last byte so that byte will be carried forward. Only 4 bits need to be looked at for this step so grab the next byte as well:

- Use the last byte (0xf6) plus the next byte (0x88) = 0xf688
- Swap the bytes = 0x88f6
- 0x88f6 in binary form = 1000 1000 1111 0110
- Ignore the processed bits from the last step = 1000 1000 1XXX XXXX
- Ignore the 5 MSB bits leaving 4 bits for processing =

xxxx	x000	1xxx	xxxx	
		1		= Data Format Flag (1 bit)
	000			= Ref Data Block (3 bits)

The Data Format Flag identifies that this batch of data is Differential (1) data.

The Ref Data Block ID is 0x000. The Ref Data Block ID here identifies that this differential data will be calculated from the Reference data that had a Ref Data Block ID equaling 000 (which was determined in the RANGECMP4 log at time 507977.00 seconds).



The 5 MSBs have not been processed so this byte will be carried forward.

Logs between seconds will be Differential logs but could be Reference logs depending on the compression calculations. If a discontinuity occurred that made it impossible for a Differential calculation to fit within the Differential Constraints, it will revert to a Reference log.

A.2.4 Differential Measurement Block

This block is sent once for each bit set to 1 in the Included Signals field found in *Table 134: Satellite and Signal Block* on page 633. Use *Table 138: Primary Differential Signal Measurement Block* on page 637 and *Table 139: Secondary Differential Signals Measurement Block* on page 639 to determine the contents of each field:

A Measurement Block for a single PRN will look like the following:

Primary Parity Flag

Primary $\frac{1}{2}$ Cycle Slip Flag
Primary C/No
Primary Lock Time
Primary Pseudorange Std Deviation
Primary Phaserange Std Deviation
Primary Pseudorange
Primary Phaserange - Primary Pseudorange (determines the Phaserange for the 1st Signal)
Primary Doppler

2nd Parity Flag
2nd $\frac{1}{2}$ Cycle Slip Flag
2nd C/No
2nd Lock Time
2nd Pseudorange Std Deviation
2nd Phaserange Std Deviation
2nd Pseudorange - Primary Pseudorange (determines the Pseudorange for the 2nd Signal)
2nd Phaserange - 2nd Pseudorange (determines the Phaserange for the 2nd Signal)
2nd Doppler - Primary Doppler (determines the Doppler for the 2nd Signal)

3rd Parity Flag
3rd $\frac{1}{2}$ Cycle Slip Flag
3rd C/No
3rd Lock Time
3rd Pseudorange Std Deviation
3rd Phaserange Std Deviation
3rd Pseudorange - Primary Pseudorange (determines the Pseudorange for the 3rd Signal)
3rd Phaserange - 3rd Pseudorange (determines the Phaserange for the 3rd Signal)
3rd Doppler - Primary Doppler (determines the Doppler for the 3rd Signal)

...

A.2.5 Differential Primary Signal Measurement Block GPS PRN 10 – L1CA

The next bytes collected will be for the GPS PRN 10 - L1CA signal data. Since this is the primary signal of the PRN, its Measurement Block consists of 78 bits as listed in *Table 138: Primary Differential Signal Measurement Block* on page 637.

The signal info section (top 25 bits) is processed as follows:

- With 5 bits left from the previous byte, we calculate $25 - 5 = 20$ bits which rounds up to 3 bytes. Therefore the previous last byte (0x88) plus the next 3 bytes will be needed.
 - Use the last byte (0x88) plus grab 3 bytes (x831f61) = 0x88831f61
 - Swap the bytes = 0x611f8388
 - 0x611f8388 in binary form
= 0110 0001 0001 1111 1000 0011 1000 1000
 - Only need 25 bits. The last byte uses the 5 MSBs and the first byte ignores the 4 MSBs

XXXX	0001	0001	1111	1000	0011	1000	1XXX	1	= Parity Flag
								0	= ½ Cycle Slip Flag
				1000	0011	100			= C/No
			1111						= Lock Time
	0001								= Pseudorange Std Deviation
	0001								= Phasorange Std Deviation
- Parity flag is a 1 (Parity Known)
- ½ Cycle Slip flag is a 0 (Cycle Slip Not Present)
- C/No is:
0x10000011100b = 1052 x Scaling factor of 0.05
= 52.60 dBHz
- The Lock Time value is:
0x1111b = 15 which means that this signal has been locked for 262144 ms or more.
- The Pseudorange Std Deviation value is:
0x0001b = 1 which means: 0.020 m < PSR Std Dev <= 0.030 m using *Table 143: Pseudorange Std Dev* on page 642.
- The ADR Std Deviation value is:
0x0001b = 1 which means: 0.0039 < ADR Std Dev <= 0.0052 cycles using *Table 142: ADR Std Dev* on page 641Table 10.
- For the following calculations, the time difference between the Differential Log and the Reference log is 0.25 seconds as shown below:
Time Difference = Current Log Time – Reference log Time
= 507977.250 - 507977.000
= 0.250 seconds

The signal data section (bottom 53 bits) is processed as follows:

- With 4 bits unprocessed from the previous byte, we calculate $53 - 4 = 49$ bits = 7 bytes (7 bits will not be processed in the last byte).
 - Use the last byte (0x61) plus grab 7 bytes (0x02005500e70162)
= 0x6102005500e70162
 - Swap the bytes = 0x6201e70055000261
 - 0x6201e70055000261 in binary form =

0110 0010 0000 0001 1110 0111 0000 0000 0101 0101 0000 0000 0000 0010 0110 0001

- Only need 53 bits. Ignore last 4 LSBs and first 7 MSBs =

```

xxxx xxx0 0000 0001 1110 0111 0000 0000 0101 0101 0000 0000 0000 0010 0110 xxxx
                                000 0000 0000 0010 0110           = 1st Pseudo - Predicted Pseudo
                                000 0000 0101 0101 0           = 1st Phase - Predicted Phase
0 0000 0001 1110 0111 0                                         = 1st Doppler - Ref Doppler
    
```

- Use *Table 138: Primary Differential Signal Measurement Block* on page 637 to identify if a 2's Complement Conversion is needed as well as what Scale Factor should be used before these binary numbers are used in the following calculations.

- The 1st (Primary) Differential Pseudorange is processed by:

$$\begin{aligned} \text{Predicted Pseudorange} &= \text{Reference 1st Pseudorange} + (\text{1st Doppler} \times \text{TimeDifference}) \\ &= 21540181.930275 \text{ m} \\ &= 21540290.811 \text{ m} + ((-435.5229 \text{ m/s}) \times 0.250 \text{ s}) \end{aligned}$$

$$\begin{aligned} \text{1st DiffPseudorange} - \text{Predicted Pseudorange} &= 0x0000000000000100110b \times \text{Scaling Factor} \\ \text{1st DiffPseudorange} - 21540181.930275 \text{ m} &= 38 \times 0.0005 \\ \text{L1CA Pseudorange for PRN 10} &= 21540181.949275 \text{ m} \end{aligned}$$

- The 1st (Primary) Differential Phaserange is a 2's Complement number (as identified by the Range column in *Table 138: Primary Differential Signal Measurement Block* on page 637) so it is processed in the following manner:

$$\begin{aligned} \text{Predicted Phaserange} &= \text{Reference 1st DiffPhaserange} + (\text{1st Doppler} \times \text{TimeDifference}) \\ &= 21540291.5622 \text{ m} + ((-435.5229 \text{ m/s}) \times 0.250 \text{ s}) \\ &= 21540182.681475 \text{ m} \end{aligned}$$

$$\begin{aligned} \text{1st DiffPhaserange} - \text{Predicted Phaserange} &= 2's \text{ Complement}(0x0000000010101010b) * \\ &\text{Scaling Factor} \\ \text{1st DiffPhaserange} - 21540182.681475 \text{ m} &= 170 * 0.0001 \\ \text{L1CA Phaserange} &= 21540182.698475 \text{ m} \end{aligned}$$

- Convert this to ADR to check against the original RANGE log:

$$\begin{aligned} \text{ADR} &= \text{1st DifPhaserange} * \text{Frequency} * (-1)/\text{Speed Of Light} \\ \text{ADR} &= 21540182.698475 \text{ m} * 1575420000 \text{ Hz} * (-1)/299792458 \text{ m/s} \\ \text{L1CA ADR for PRN 10} &= -113194424.0799796 \text{ cycles} \end{aligned}$$

 In the range logs, PSR and ADR have opposite signs.

- The 1st (Primary) Differential Doppler is a 2's Complement number (as identified by the Range column in *Table 138: Primary Differential Signal Measurement Block* on page 637) so it is processed in the following manner:

$$\begin{aligned} \text{1st DiffDoppler(m/s)} - \text{Reference 1st Doppler} &= 2's \text{ Complement}(0x000000001111001110b) \times \\ &\text{Scaling Factor} \\ \text{1st DiffDoppler(m/s)} - (-435.5229 \text{ m/s}) &= 974 \times 0.0001 \\ \text{L1CA Doppler(m/s)} &= -435.4255 \text{ m/s} \end{aligned}$$

Convert the Doppler to Hz:

$$\begin{aligned} \text{1st DiffDoppler(Hz)} &= \text{1st DiffDoppler(m/s)} \times \text{Frequency} * (-1)/\text{Speed Of Light} \\ \text{1st DiffDoppler(Hz)} &= -435.4255 \text{ m/s} \times 1575420000 \text{ Hz} * (-1)/299792458 \text{ m/s} \\ \text{L1CA Doppler(Hz) for PRN 10} &= 2288.1764464 \text{ Hz} \end{aligned}$$

A.2.6 Differential Secondary Signals Measurement Block GPS PRN 10 – L2Y

Unlike Reference logs which always reflect back to the initial signal for their computations, Differential logs uses the last Reference log data of the same signal for its calculations.

- With 7 bits unprocessed from the previous byte, we will require $74 - 7 = 67$ bits which rounds up to 9 bytes.
 - Use the last byte (0x62) plus grab the next 9 bytes (0xdc977c004015c07988) = 0x62dc977c004015c07988
 - Swap the bytes = 0x8879c01540007c97dc62
 - 0x8879c01540007c97dc62 in binary form =
1000 1000 0111 1001 1100 0000 0001 0101 0100 0000 0000 0000 0111 1100 1001 0111 1101 1100 0110 0010
 - Only need 74 bits. The 1 LSB is ignored as it was already processed above and the 5 MSBs are ignored so there is a total of 74 bits to process

```

XXXX X000 0111 1001 1100 0000 0001 0101 0100 0000 0000 0000 0111 1100 1001 0111 1101 1100 0110 001X
                                                                 1 = Parity Flag
                                                                 0 = ½ Cycle Slip Flag
                                                                 01 1100 0110 0 = C/No
                                                                 11 11 = Lock Time
                                                                 01 01 = Pseudorange Std Deviation
                                                                 00 10 = Phasorange Std Deviation
                                                                 0 0000 0000 0000 0111 11 = Pseudo - Predicted Pseudo
                                                                 0 0000 0001 0101 010 = Phase - Predicted Phase
000 0111 1001 110
    
```

- Parity flag is a 1 (Parity Known)
- ½ Cycle Slip flag is a 0 (Cycle Slip Not Present)
- C/No is:
0x01110001100b = 908 x Scaling Factor of 0.05
= 45.4 dBHz
- The Lock Time value is:
0x1111b = 15 which means that this signal has been locked for 262144 ms or more.
- The Pseudorange Std Deviation value is:
0x0101b = 5 which means: $0.099 \text{ m} < \text{PSR Std Dev} \leq 0.148 \text{ m}$ using *Table 143: Pseudorange Std Dev* on page 642.
- The ADR Std Deviation value is:
0x0010b = 2 which means: $0.0052 < \text{ADR Std Dev} \leq 0.0070$ cycles using *Table 142: ADR Std Dev* on page 641.
- The L2Y Pseudorange is a 2's Complement number (as identified by the Range column in *Table 139: Secondary Differential Signals Measurement Block* on page 639) so it is processed in the following manner:

$$\text{Predicted Pseudorange} = \text{Reference 2nd Pseudorange} + (\text{2nd Doppler} \times \text{TimeDifference})$$

$$= 21540293.6315 \text{ m} + ((-435.523 \text{ m/s}) \times 0.250 \text{ s})$$

$$= 21540184.75075 \text{ m}$$

$$\text{DiffPseudorange} - \text{Predicted Pseudorange} = 2\text{'s Complement}(0x00000000000000111111b) \times \text{Scaling Factor}$$

$$\text{DiffPseudorange} - 21540184.75075 \text{ m} = 31 \times 0.0005$$

$$\text{L2Y Pseudorange} = 21540184.76625 \text{ m}$$
- The L2Y Phasorange is a 2's Complement number (as identified by the Range column in *Table*

139: *Secondary Differential Signals Measurement Block* on page 639) so it is calculated in the following manner:

$$\begin{aligned} \text{Predicted Phaserange} &= \text{Reference 2nd DiffPhaserange} + (2\text{nd Doppler} \times \text{TimeDifference}) \\ &= 21540294.399 \text{ m} + ((-435.523 \text{ m/s}) \times 0.250 \text{ s}) \\ &= 21540185.51825 \text{ m} \end{aligned}$$

DiffPhaserange – Predicted Phaserange = 2's Complement(0x0000000010101010b) * Scaling Factor

$$\text{DiffPhaserange} - 21540185.51825 \text{ m} = 170 * 0.0001$$

$$\text{L2Y Phaserange} = 21540185.53525 \text{ m}$$

- Convert this to ADR to check against the original RANGE log:

$$\text{ADR} = \text{Phaserange} * \text{Frequency} * (-1)/\text{Speed Of Light}$$

$$\text{ADR} = 21540185.53525 \text{ m} * 1227600000 \text{ Hz} * (-1)/299792458 \text{ m/s}$$

$$\text{L2Y ADR for PRN 10} = -88203458.95116848 \text{ cycles}$$



In the range logs, PSR and ADR have opposite signs.

- The L2Y Doppler is a 2's Complement number (as identified by the Range column in *Table 139: Secondary Differential Signals Measurement Block* on page 639) so it is calculated in the following manner:

DiffDoppler(m/s) – Ref 2nd Doppler(m/s) = 2's Complement(0x00001111001110b) x Scaling Factor

$$\text{DiffDoppler(m/s)} - (-435.5229 \text{ m/s}) = (974) \times 0.0001$$

$$\text{L2Y Doppler(m/s)} = -435.4255 \text{ m/s}$$

Convert the Doppler to Hz:

$$\text{Doppler(Hz)} = \text{Doppler(m/s)} \times \text{Frequency} * (-1)/\text{Speed Of Light}$$

$$\text{Doppler(Hz)} = -435.4255 \text{ m/s} \times 1227600000 \text{ Hz} * (-1)/299792458 \text{ m/s}$$

$$\text{L2Y Doppler(Hz) for PRN 10} = 1782.994633 \text{ Hz}$$

A.2.7 Differential Third Signals Measurement Block GPS PRN 10 – L5Q

Unlike Reference logs which always reflect back to the initial signal for their computations, Differential logs uses the last Reference log data of the same signal for its calculations.

- With 3 bits unprocessed from the previous byte, we will require $74 - 3 = 71$ bits which rounds up to 9 bytes.
 - Use the last byte (0x88) plus grab the next 9 bytes (0x 840f6101803a805921) = 0x88840f6101803a805921
 - Swap the bytes = 0x2159803a8001610f8488
 - 0x2159803a8001610f8488 in binary form =
0010 0001 0101 1001 1000 0000 0011 1010 1000 0000 0000 0001 0110 0001 0000 1111
1000 0100 1000 1000
 - Only need 74 bits. The 3 LSBs are ignored as they were already processed and the 3 MSBs are ignored so there is a total of 74 bits to process.

```

    XXX0 0001 0101 1001 1000 0000 0011 1010 1000 0000 0000 0001 0110 0001 0000 1111 1000 0100 1000 1XXX
                                                                                               1 = Parity Flag
                                                                                               0 = ½ Cycle Slip Flag
                                                                                               1000 0100 100 = C/No
                                                                                               1111 = Lock Time
                                                                                               0000 = Pseudorange Std Deviation
                                                                                               0001 = Phaserange Std Deviation
                                                                                               000 0000 0011 1010 1 = Pseudo - Predicted Pseudo
                                                                                               0 0001 0101 1001 1 = Phase - Predicted Phase
                                                                                               = Doppler - Ref Doppler
    
```

- Parity flag is a 1 (Parity Known)
- ½ Cycle Slip flag is a 0 (Cycle Slip Not Present)
- C/No is:
 $0x10000100100b = 1060 \times \text{Scaling factor of } 0.05$
 $= 53.0 \text{ dBHz}$
- The Lock Time value is:
 $0x1111b = 15$ which means that this signal has been locked for 262144 ms or more.
- The Pseudorange Std Deviation value is:
 $0x0000b = 0$ which means: PSR Std Dev ≤ 0.020 m using *Table 143: Pseudorange Std Dev* on page 642.
- The ADR Std Deviation value is:
 $0x0001b = 1$ which means: $0.0039 < \text{ADR Std Dev} \leq 0.0052$ cycles using *Table 142: ADR Std Dev* on page 641.
- The L5Q Pseudorange is a 2's Complement number (as identified by the Range column in *Table 139: Secondary Differential Signals Measurement Block* on page 639) so it is processed in the following manner:

$$\begin{aligned} \text{Predicted Pseudorange} &= \text{Reference 3rd Pseudorange} + (\text{3rd Doppler} \times \text{TimeDifference}) \\ &= 21540289.869 \text{ m} + ((-435.5149 \text{ m/s}) \times 0.250 \text{ s}) \\ &= 21540180.990275 \text{ m} \end{aligned}$$

$$\begin{aligned} \text{DiffPseudorange} - \text{Predicted Pseudorange} &= 2\text{'s Complement}(0x000\ 0000\ 0000\ 0001\ 0110b) \\ &\times \text{Scaling Factor} \\ \text{DiffPseudorange} - 21540180.990275 \text{ m} &= 22 \times 0.0005 \\ \text{L5Q Pseudorange} &= 21540181.001275 \text{ m} \end{aligned}$$
- The L5Q Phaserange is a 2's Complement number (as identified by the Range column in *Table 139: Secondary Differential Signals Measurement Block* on page 639) so it is calculated in the following manner:

$$\begin{aligned} \text{Predicted Phaserange} &= \text{Reference 3rd DiffPhaserange} + (\text{3rd Doppler} \times \text{TimeDifference}) \\ &= 21540290.8584 \text{ m} + ((-435.5149 \text{ m/s}) \times 0.250 \text{ s}) \\ &= 21540181.979675 \text{ m} \end{aligned}$$

$$\begin{aligned} \text{DiffPhaserange} - \text{Predicted Phaserange} &= 2\text{'s Complement}(0x0000000001110101b) \times \text{Scaling} \\ &\text{Factor} \\ \text{DiffPhaserange} - 21540181.979675 \text{ m} &= 117 \times 0.0001 \\ \text{L5Q Phaserange} &= 21540181.991375 \text{ m} \end{aligned}$$
- Convert this to ADR to check against the original RANGE log:

$$\begin{aligned} \text{ADR} &= \text{Phaserange} \times \text{Frequency} \times (-1)/\text{Speed Of Light} \\ \text{ADR} &= 21540181.991375 \text{ m} \times 1176450000 \text{ Hz} \times (-1)/299792458 \text{ m/s} \\ \text{L5Q ADR for PRN 10} &= -84528300.92127641 \text{ cycles} \end{aligned}$$



In the range logs, PSR and ADR have opposite signs.

- The L5Q Doppler is a 2's Complement number (as identified by the Range column in *Table 139: Secondary Differential Signals Measurement Block* on page 639) so it is calculated in the following manner:

DiffDoppler(m/s) – Ref 3rd Doppler(m/s) = 2's Complement(0x00001010110011b) x Scaling Factor

DiffDoppler(m/s) – (-435.5149 m/s) = 691 x 0.0001

L5Q Doppler(m/s) = -435.4458 m/s

Convert this to Hz:

Doppler(Hz) = Doppler(m/s) x Frequency * (-1)/Speed Of Light

Doppler(Hz) = -435.4458 m/s x 1176450000 Hz * (-1)/299792458 m/s

L5Q Doppler(Hz) for PRN 10 = 1708.78285 Hz

This concludes the decoding of the Differential Log for PRN 10 (signals L1CA, L2Y, and L5Q). The rest of the decoding for the other PRNs and systems are handled in the same manner.

